

4EWBR24

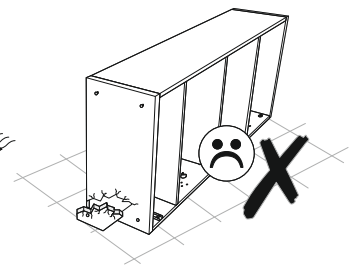
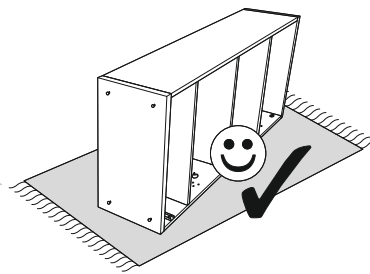
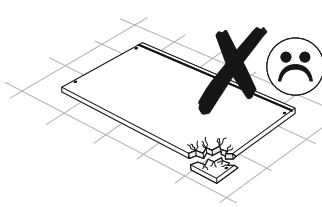
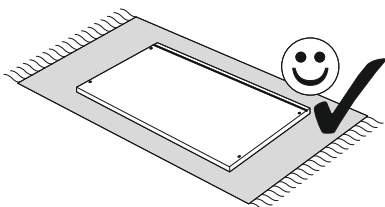
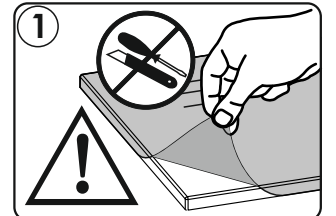
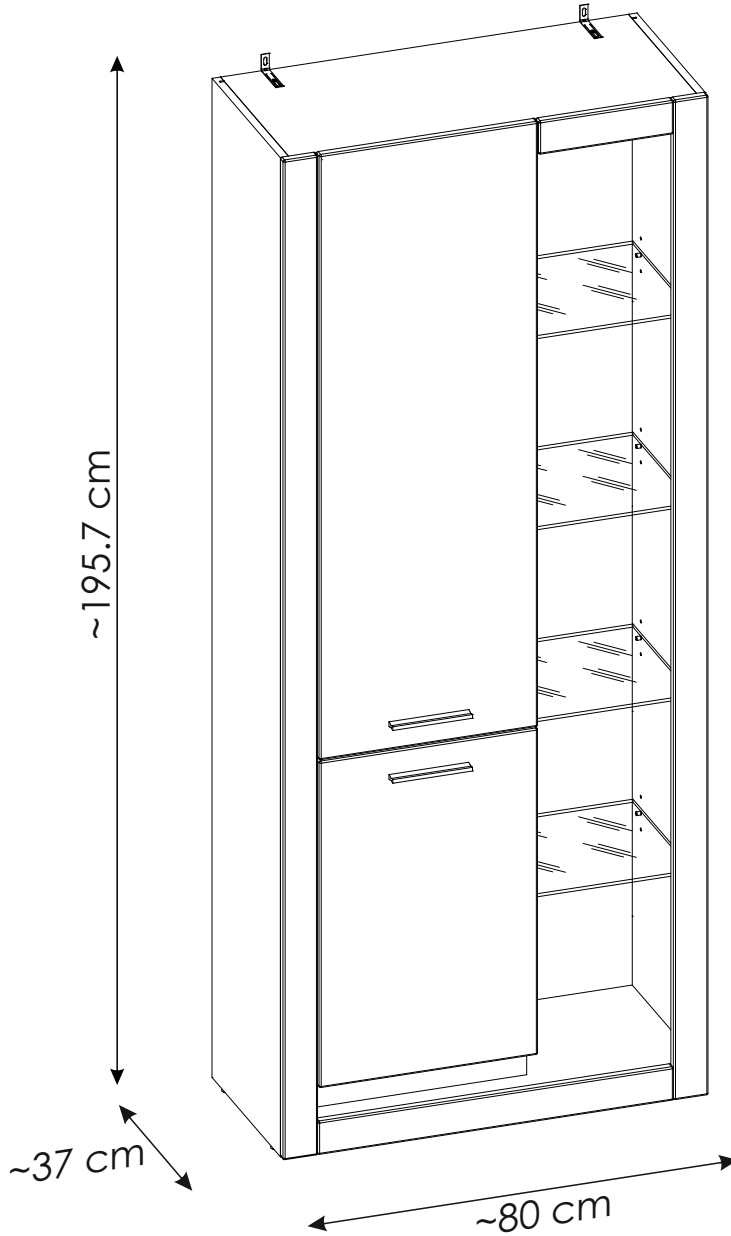
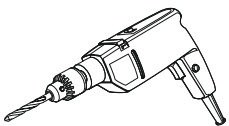
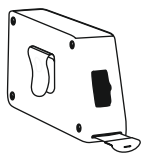
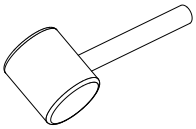
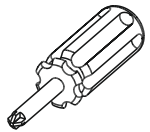
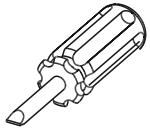
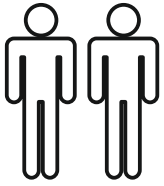

AR.

ملاحظة!

يجب تثبيت الأثاث بإحكام إلى الحائط أو الجدار لتجنب خطر إنقلابه. لا تحتوي العلبة على مسامير التثبيت، إذ إنه ينبغي إستعمال المسامير المخصصة لنوعية الحائط أو الجدار. اختر المسامير التي تناسب جدارك.

E.

¡ATENCIÓN! El mueble debe ser fijado permanentemente a la pared para evitar el riesgo relacionado con el vuelco del mueble. En el paquete no hay tornillos de fijación, ya que se debe elegir el tipo de fijación adecuado para el tipo de pared. Elija el apropiado para su tipo de pared.

CN.

注意！本家具需要固定在墙上以免倒塌。箱子里没有安装螺钉。因为安装方式需要根据墙的类型调整。请按照您的墙类型选择合适的安装方式。

SLO.

POZOR! Pohišvo trajno pritrдите na steno, da preprečite tveganje, da se prevrne. V paketu ni pritrđilnih vijakov, saj je treba način pritrđitve ustrezno izbrati glede na vrsto stene. Izberite način, ki je ustrezen za vašo steno.

HU.

FIGYELEM! Rögzítse a bútorokat a falhoz, hogy elkerülje a bútor felborulásának kockázatát. A készletben nem találhatóak rögzítőcsavarok, mivel a rögzítés típusa a fal típusától függ. Válassza ki a fal típusának megfelelő kötőelemeket.

NL.

OPMERKING! De meubelen moeten permanent aan de muur worden bevestigd om te voorkomen dat de meubelen kantelen. Er zitten geen bevestigingsschroeven in het pakket, omdat het type bevestiging moet worden gekozen op basis van het type muur. Kies de juiste voor uw type muur.

EN.

WARNING! To prevent this furniture from tripping over, fix it to the wall permanently. Fixing devices are not included since different wall materials require different types of fixing devices. Please make sure you chose the correct ones for your type of wall.

SK.

POZOR! Nábytok musí byť trvalo pripevnený k stene tak, aby sa zamedzilo riziku prevrátenia. Balík neobsahuje upevňovacie skrutky, pretože typ upevnenia je treba vybrať podľa typu steny. Vyberte typ vhodný pre Vašu stenu.

CZ.

POZOR! Nábytek je nutné pevně připevnit ke zdi, abychom se vyhnuli riziku spojenému s jeho převrnutím. Součástí balení nejsou připevňovací šrouby, protože způsoby připevnění je nutné zvolit podle druhu stěny. Vyberte správný pro Váš typ stěny.

RU.

ПРИМЕЧАНИЕ! Эту мебель необходимо всегда прикреплять к стене, чтобы избежать рисков, связанных с переворотом мебели. В пакете нет крепежных винтов, потому что тип крепления должен быть выбран в соответствии с типом стены. Выберите, пожалуйста, правильные винты к вашей стене.

RO.

ATENŢIE! Mobila trebuie ancorată permanent în perete pentru a evita riscul de răsturnare a mobilei. În pachet nu sunt incluse şuruburile de fixare, deoarece tipul de ancoraj trebuie ales în funcţie de tipul de perete. Alegeţi şuruburile potrivite pentru tipul Dvs. de perete.

TR.

DİKKAT! Devrilmeye riskini önlemek için mobilya duvara sabitlemelidir. Sabitleme civataları pakete dahil değildir, çünkü sabitleme tertibatının tipi, duvara tipine uygun olarak seçilmelidir. Onu duvarınızın tipine göre seçiniz.

PL.

UWAGA! Mebel należy trwale zamocować do ściany, aby uniknąć ryzyka związanego z przewróceniem się mebla. W paczce nie ma śrub mocujących, ponieważ rodzaj mocowania należy odpowiednio dobrać do rodzaju ściany. Dobierz właściwe do Twojego rodzaju ściany.

D.

ACHTUNG! Um alle mit dem Umkippen des Möbels verbundenen Risiken auszuschließen, muss das Möbel fest an der Wand verankert werden. Beschläge für die Wandbefestigung sind nicht beige packt, da diese von der jeweiligen Wandbeschaffenheit abhängig sind. Bitte solche Befestigungsschläge wählen, die für die heimischen Wände geeignet sind.

FR.

ATTENTION! Ce meuble doit être fixé en permanence au mur pour éviter les risques de chute. Les vis de fixation ne sont pas livrées car le type de fixation doit être choisi en fonction du type de mur. Sélectionnez les fixations adaptées au mur.

I.

ATTENZIONE! Il mobile deve essere permanentemente fissato alla parete per evitare i rischi derivanti da un ribaltamento del mobile. La confezione non include le viti di fissaggio, in quanto il tipo di fissaggio deve essere scelto in base al tipo di parete. Utilizzare viti appropriate in base al materiale della parete.

HR.

NAPOMENA! Namještaj mora biti trajno pričvršćen za zid, kako bi se izbjegao rizik od njegovog prevrtanja. U paketu nema vijaka za pričvršćivanje, jer se vrsta montaže mora prilagoditi vrsti zida. Odaberite pravu vrstu prema Vašoj vrsti zida.

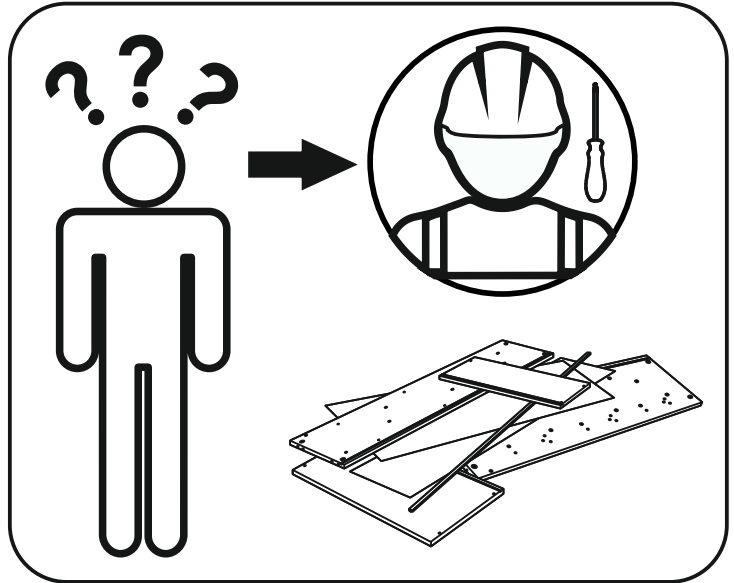
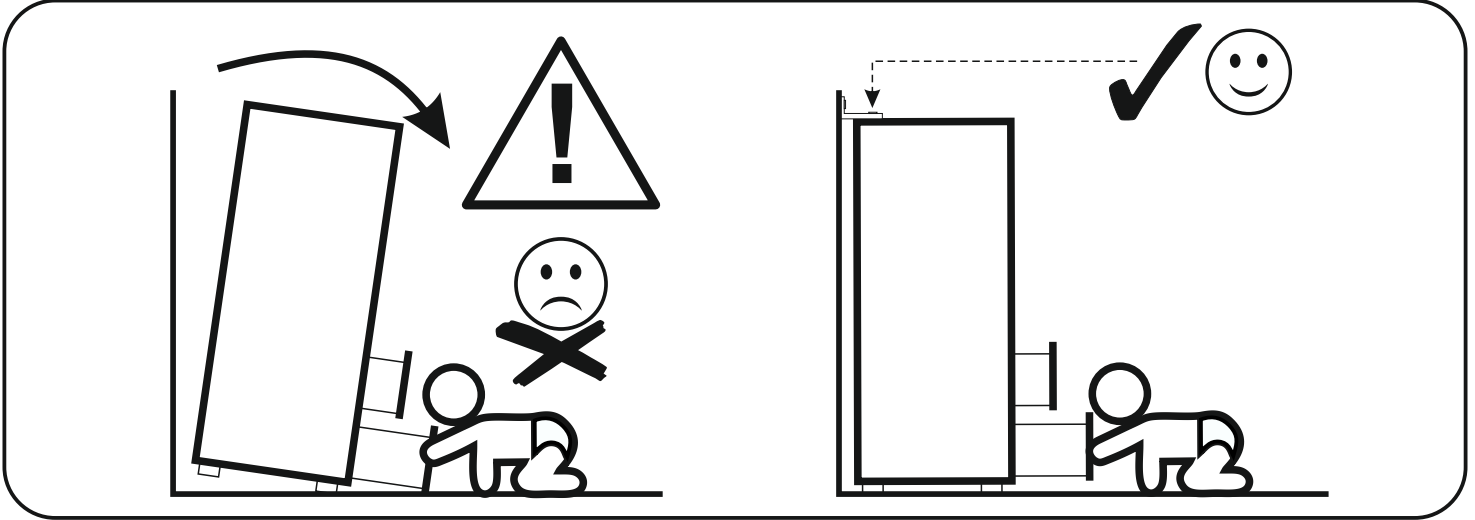



version A

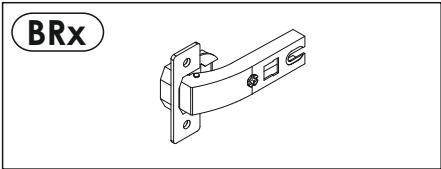
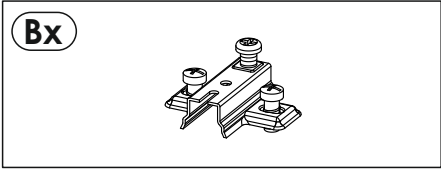



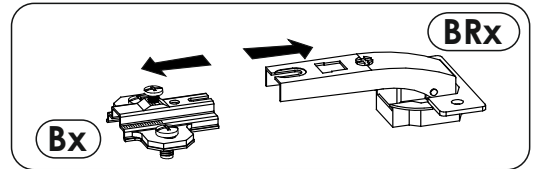
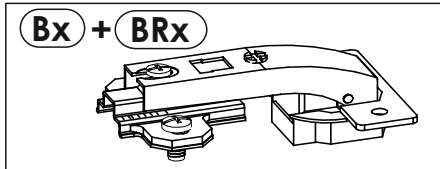







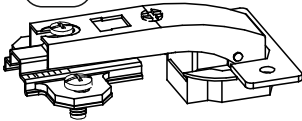

version B

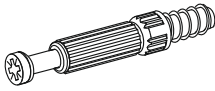
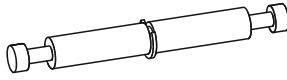
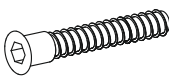
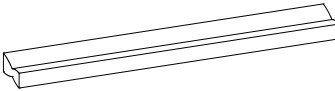
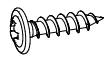
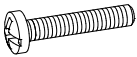
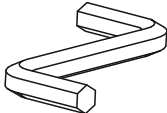

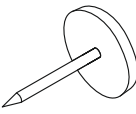
4EWBR24

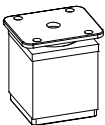
MM

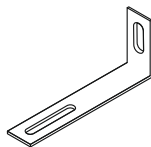
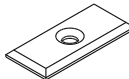
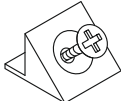
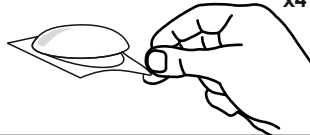
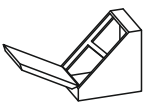
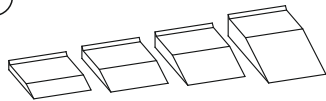
A1 8 x 35 mm x39 	A2 8 x 45 mm x3 	B7 + BR1 x5 
C2 5 x 13 mm x10 	D2 x28 	E0 Ø16 x24 
E1 15 x 12 mm x38 	F1 6 x 34 mm x32 	F3 7 x 64 mm x3 
G1 7 x 50 mm x4 	H1 L - 150 mm x2 	I2 4 x 16 mm x2 
K7 4 x 22 mm x4 	M x1 	N1 3 x 16 mm x20 
N5 3,5 x 16 mm x8 	O2 x4 	O2B ø10 x6 
O8 x1 	P2 x2 Ø8 	Q9 x2 
R1 x12 	R4 x12 	R8 x4 
W x2 	Z x1 	

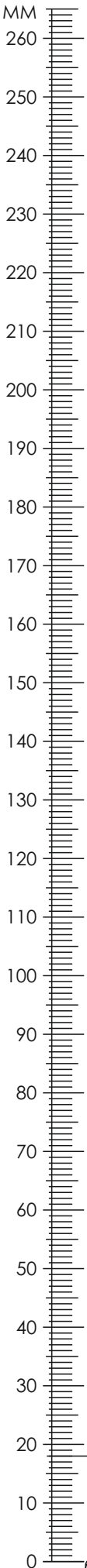
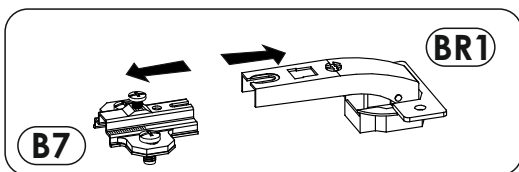

4EWBR24

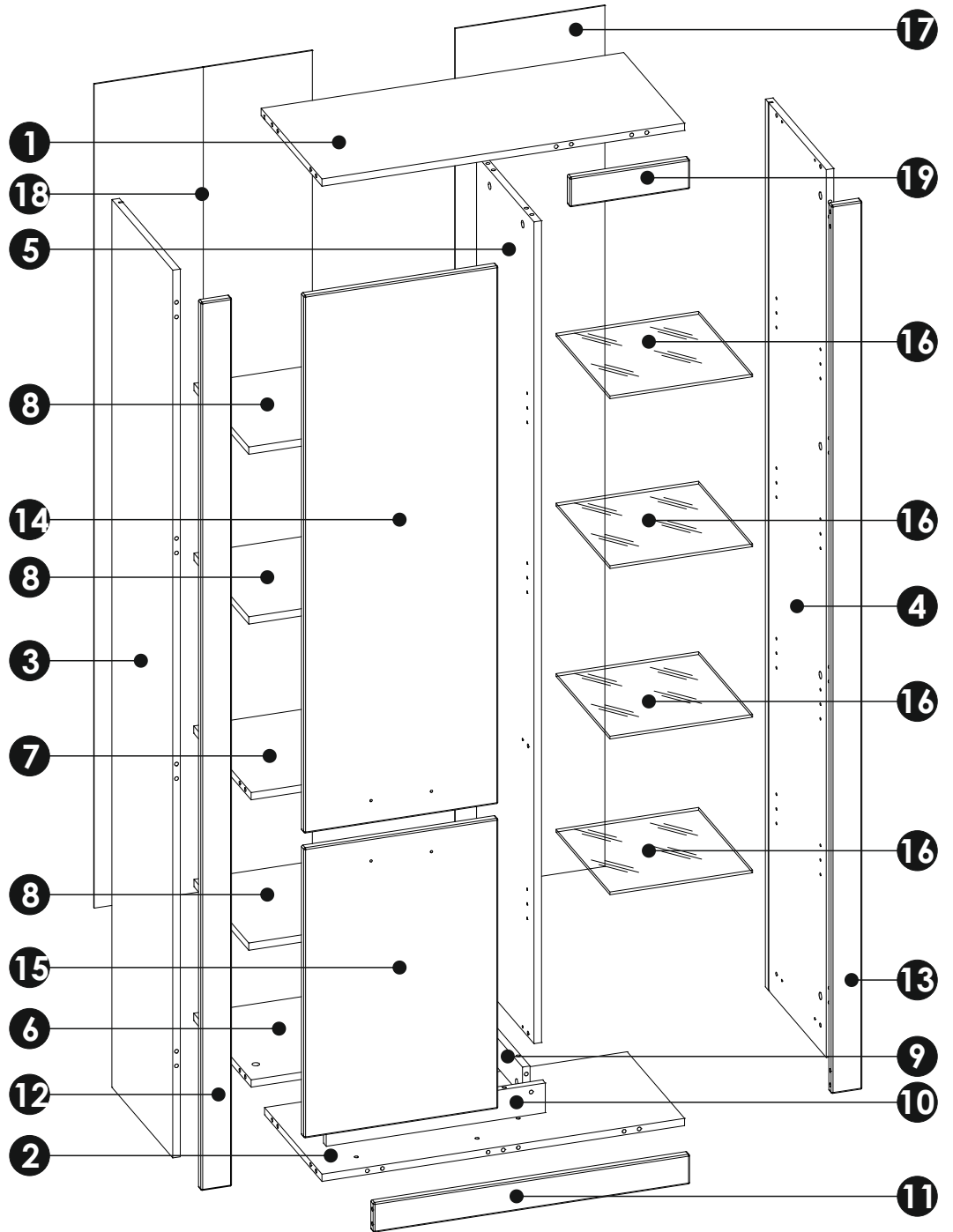
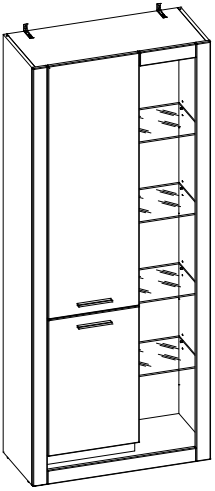

1	768	354	16	x1	1/2
2	768	334	16	x1	1/2
3	1950	354	16	x1	2/2
4	1950	354	16	x1	2/2
5	1805	334	16	x1	2/2

6	449	334	16	x1	1/2
7	449	334	16	x1	1/2
8	448	319	16	x3	1/2
9	273	65	16	x1	2/2
10	464	65	16	x1	2/2
11	670	65	16	x1	2/2
12	1951	65	16	x1	2/2

13	1951	65	16	x1	2/2
14	1181	411	16	x1	1/2
15	637	411	16	x1	1/2
16	302	314	6	x4	1/2
17	1891	317	3	x1	2/2
18	1810	462	3	x1	2/2
19	254	65	16	x1	2/2

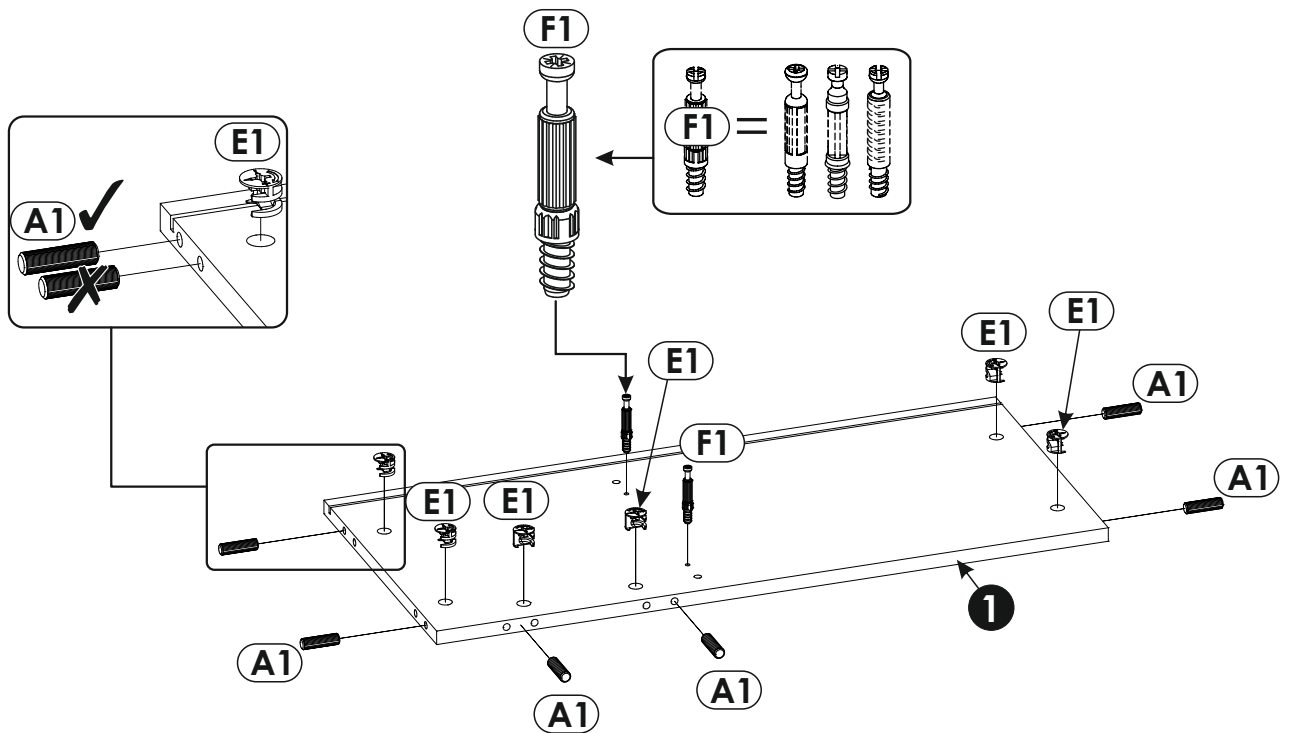
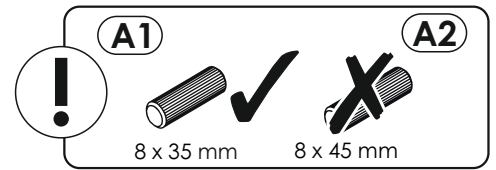
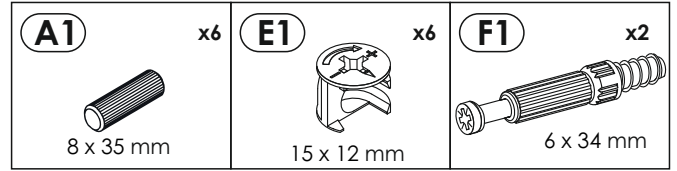
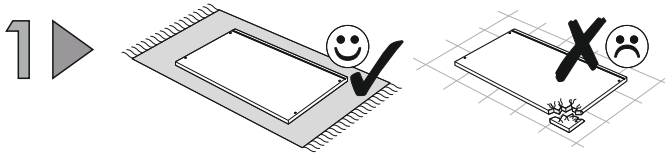
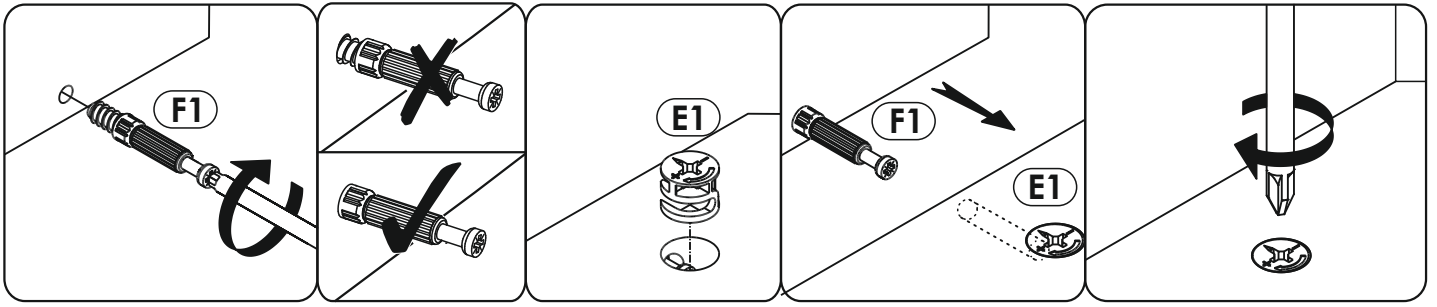

2 ▶

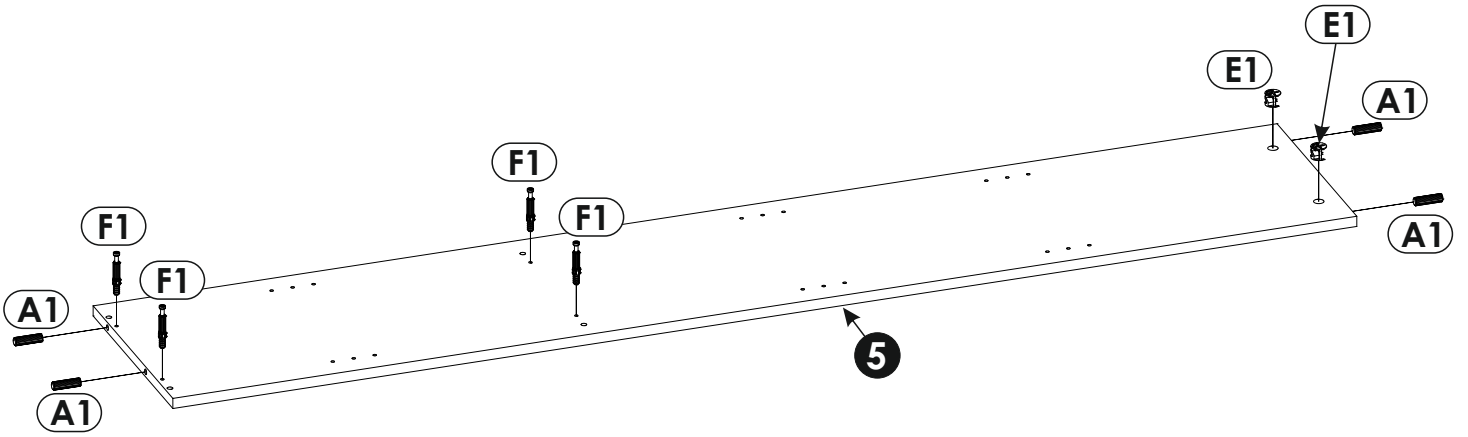
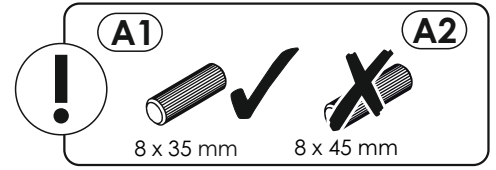
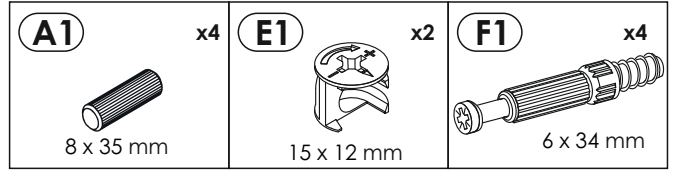
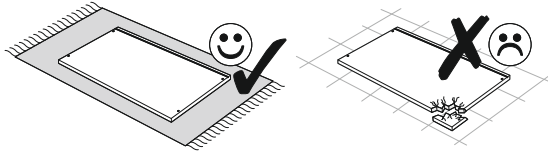

3 ▶

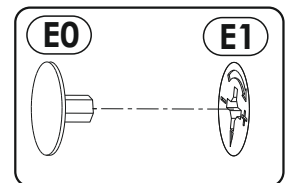
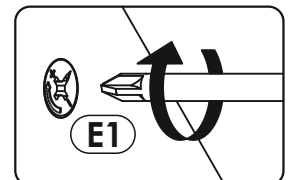
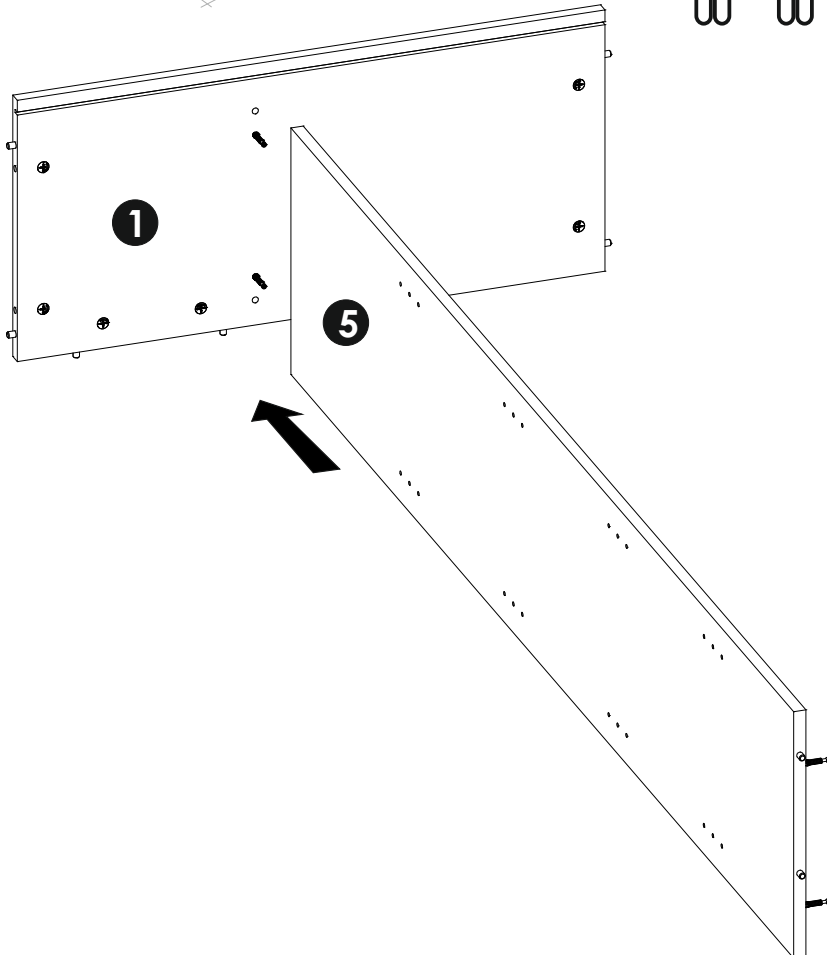
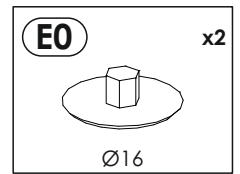
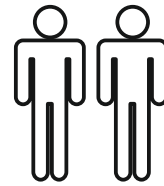
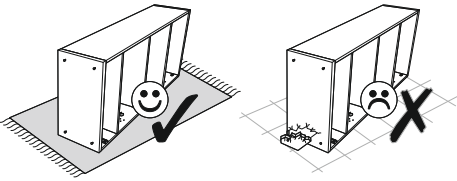

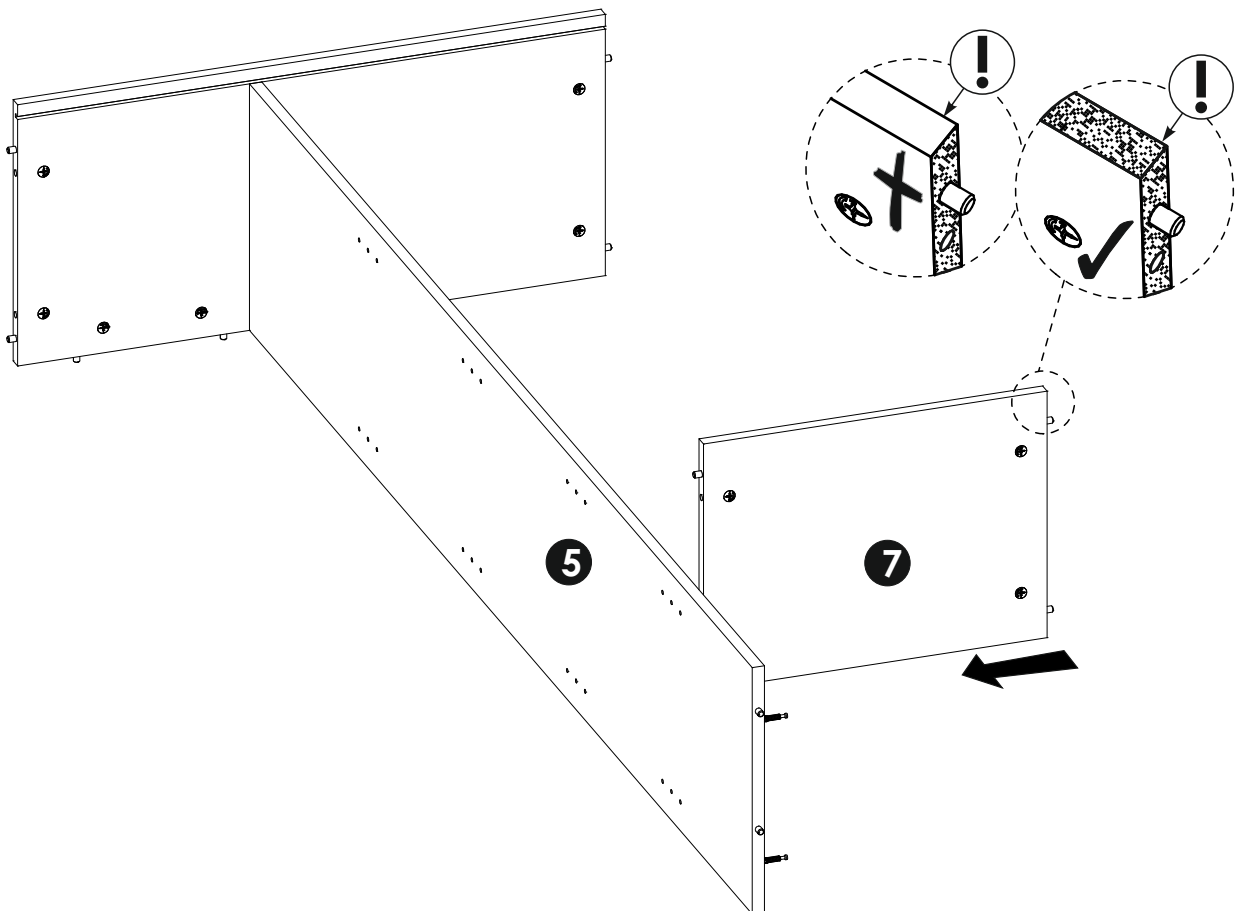
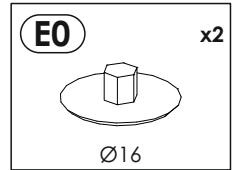
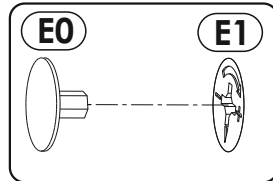
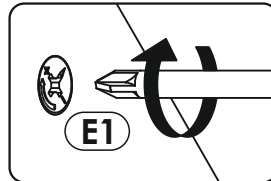
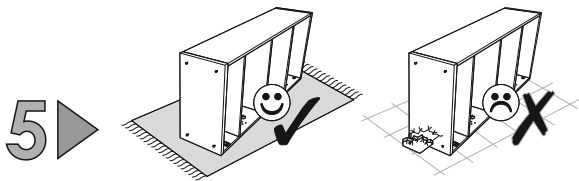
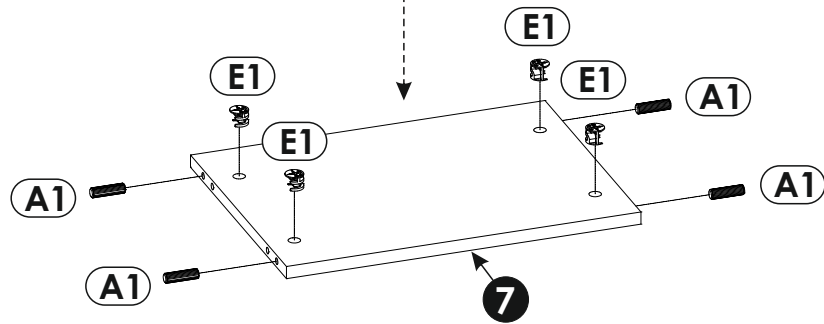
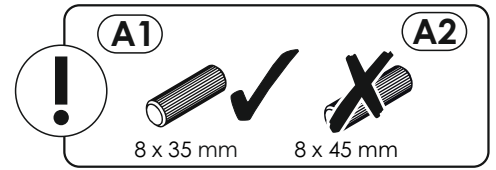
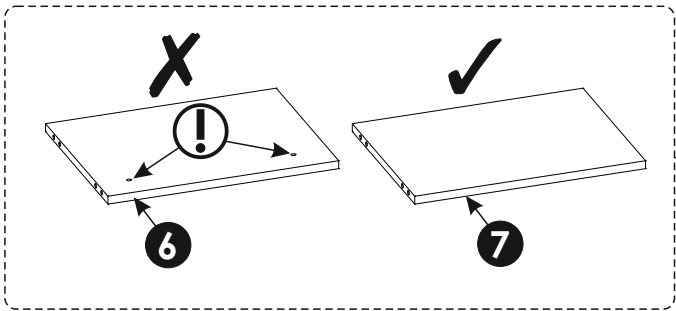
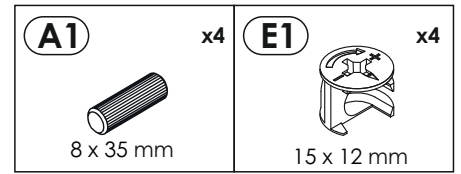
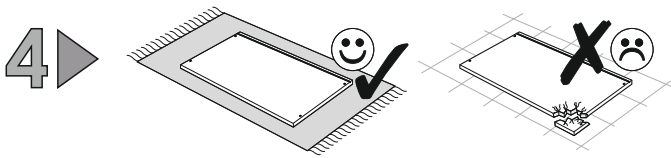

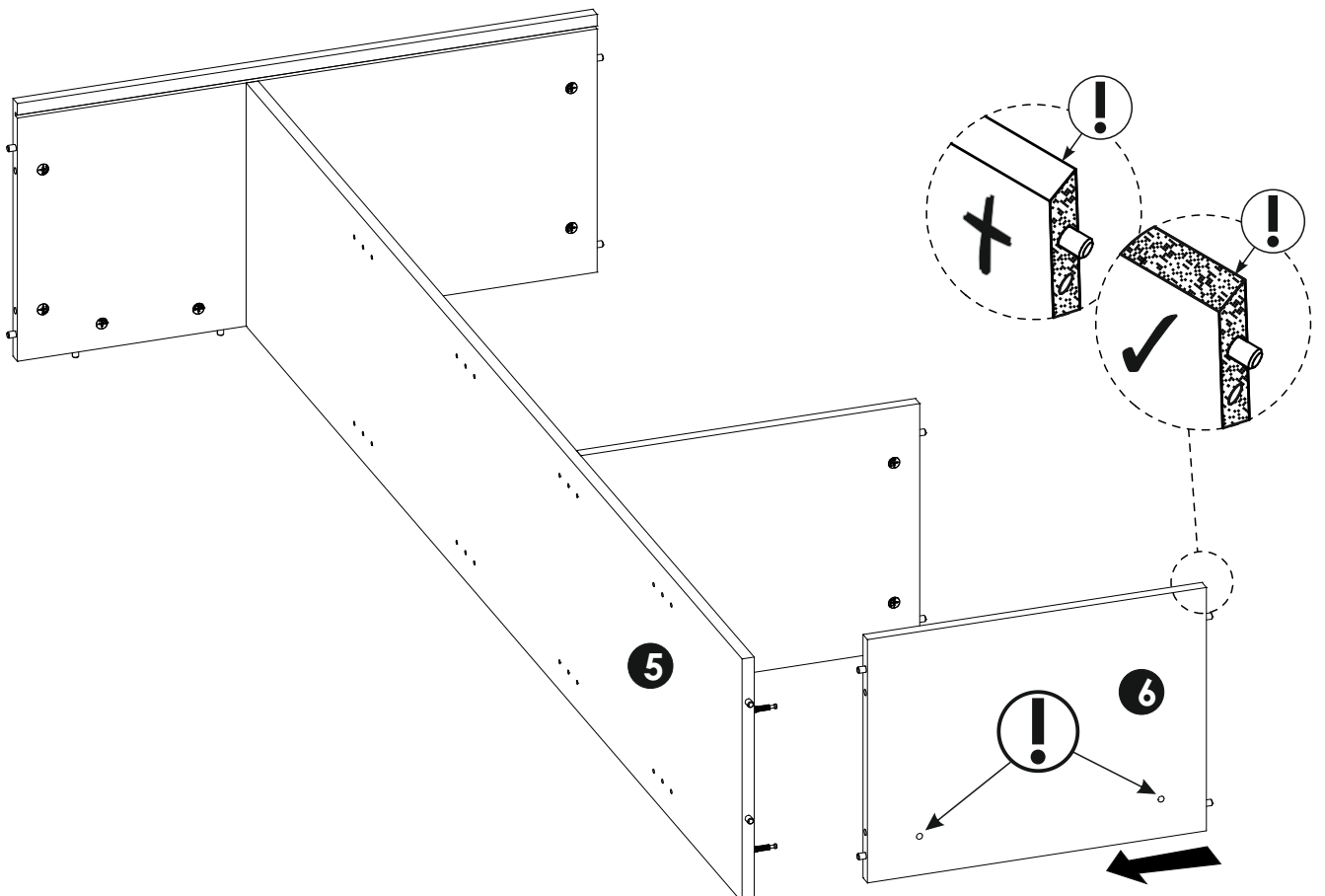
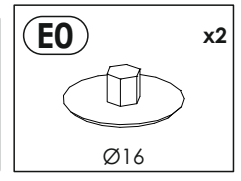
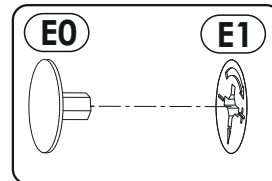
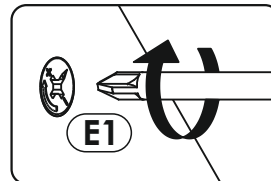
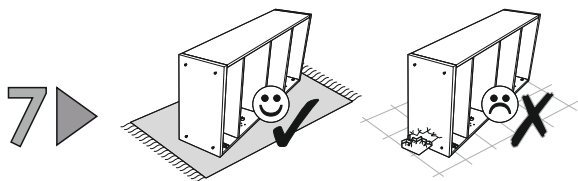
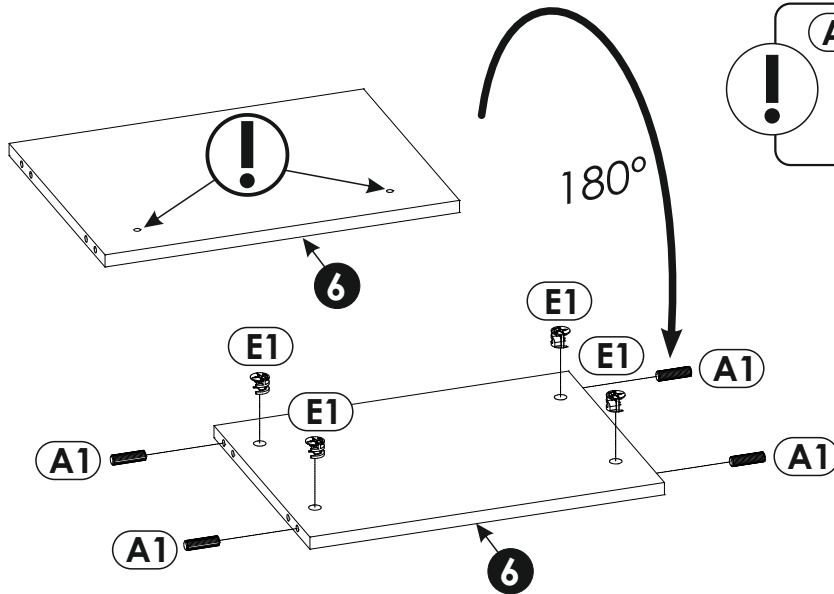
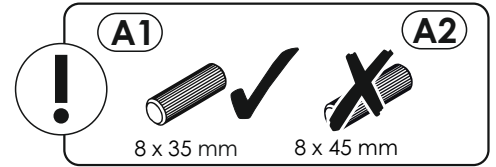
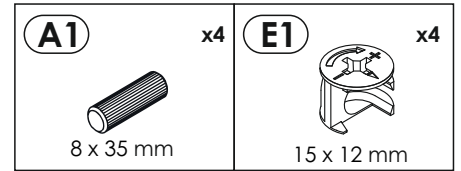
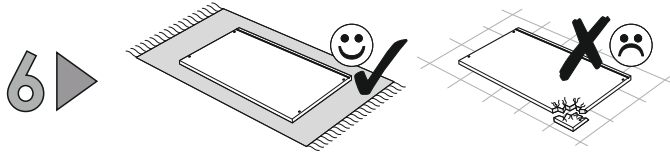

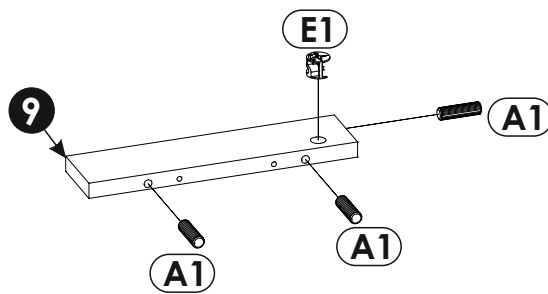
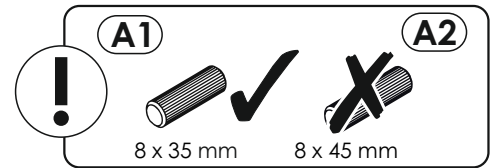
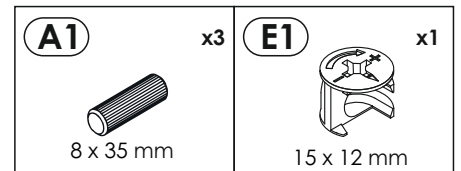
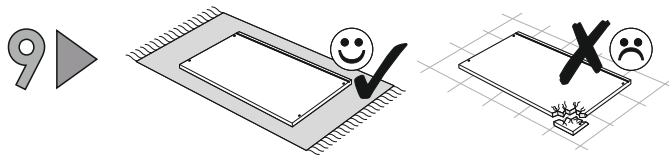
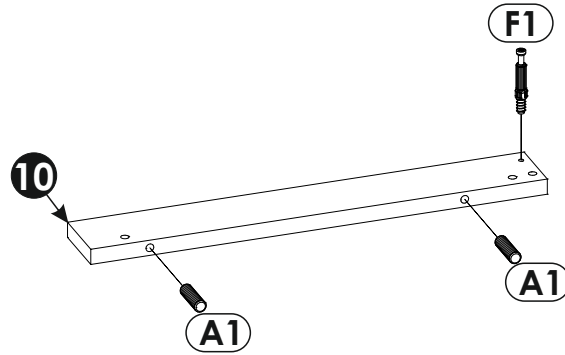
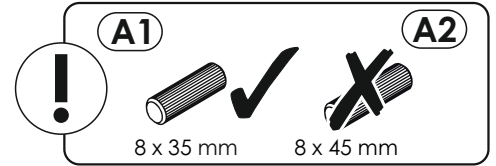
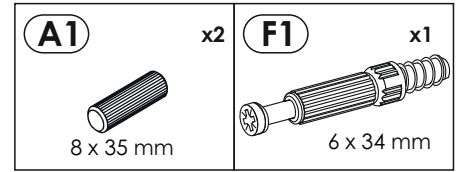
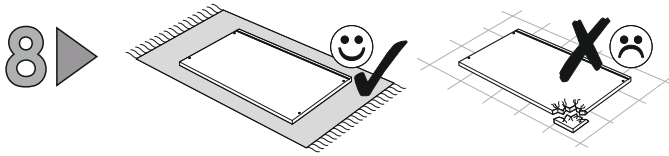

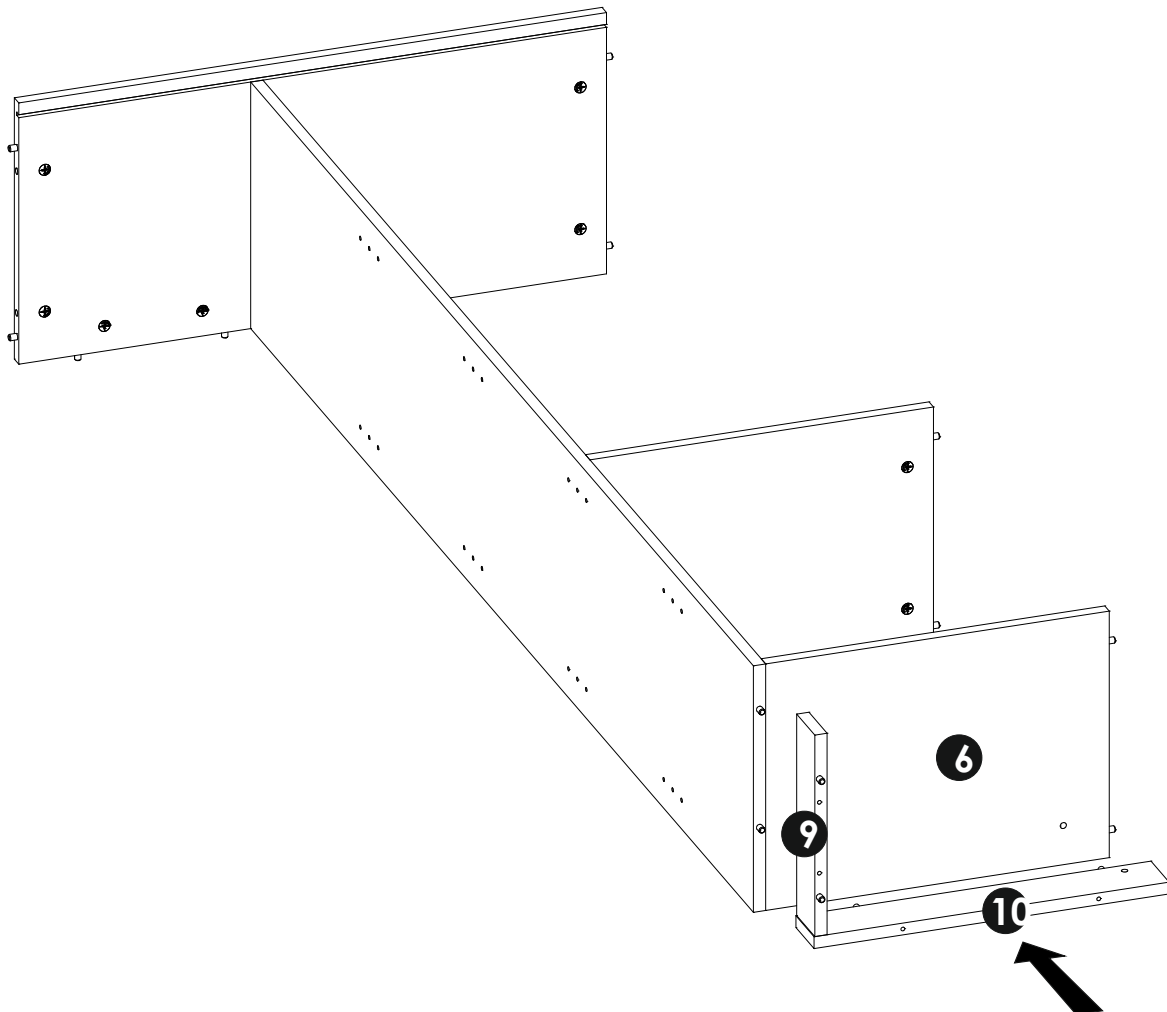
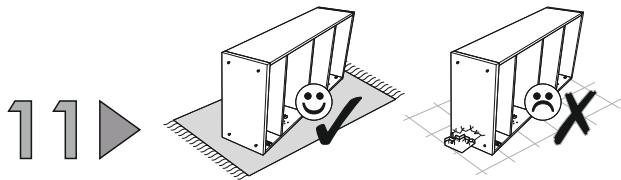
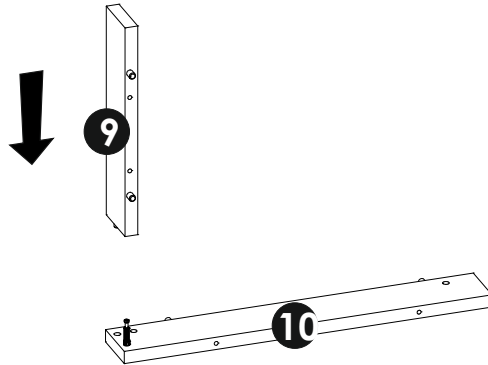
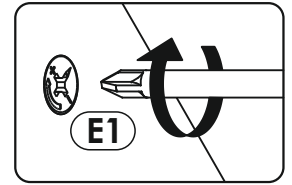
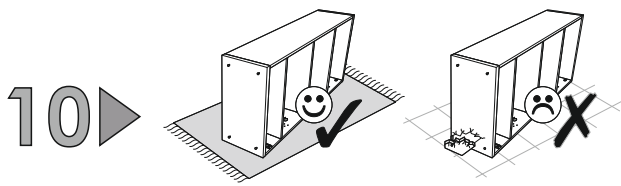

12 ▶

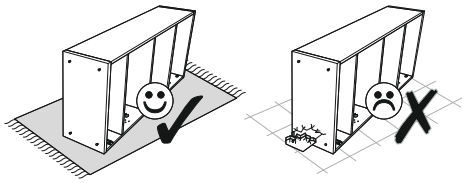

N5 x4 3,5 x 16 mm	P2 x2 Ø8	W x2
--------------------------------	-----------------------	----------------

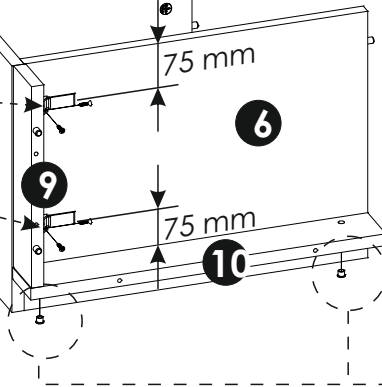
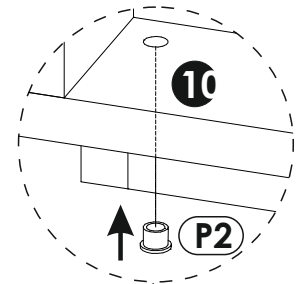
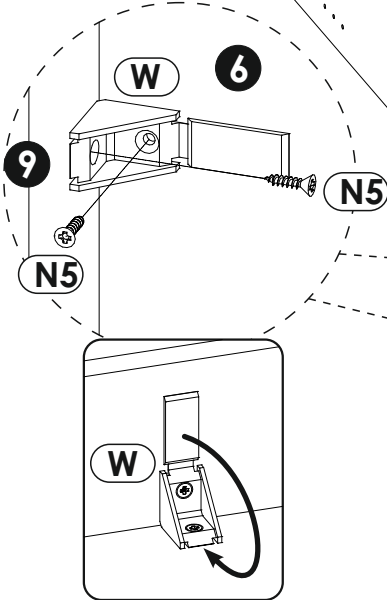
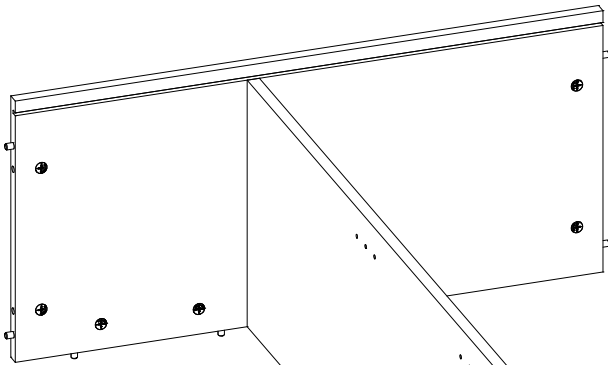

13 ▶

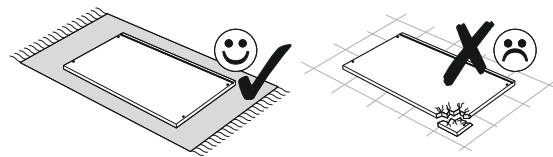

A1 x8 8 x 35 mm	E1 x7 15 x 12 mm
------------------------------	-------------------------------

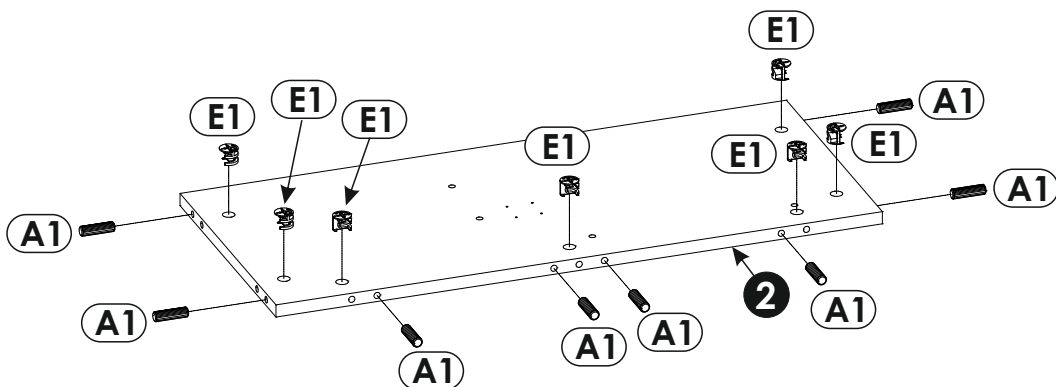
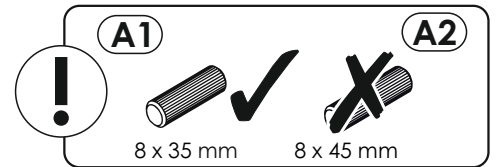

14 ▶

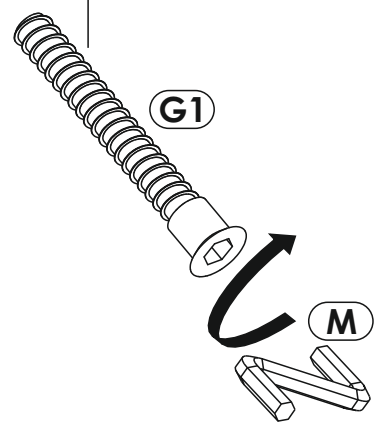
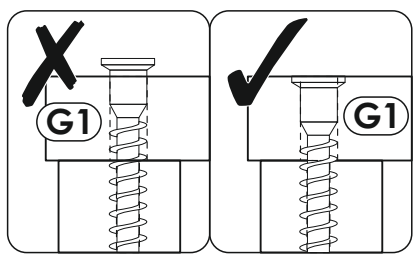
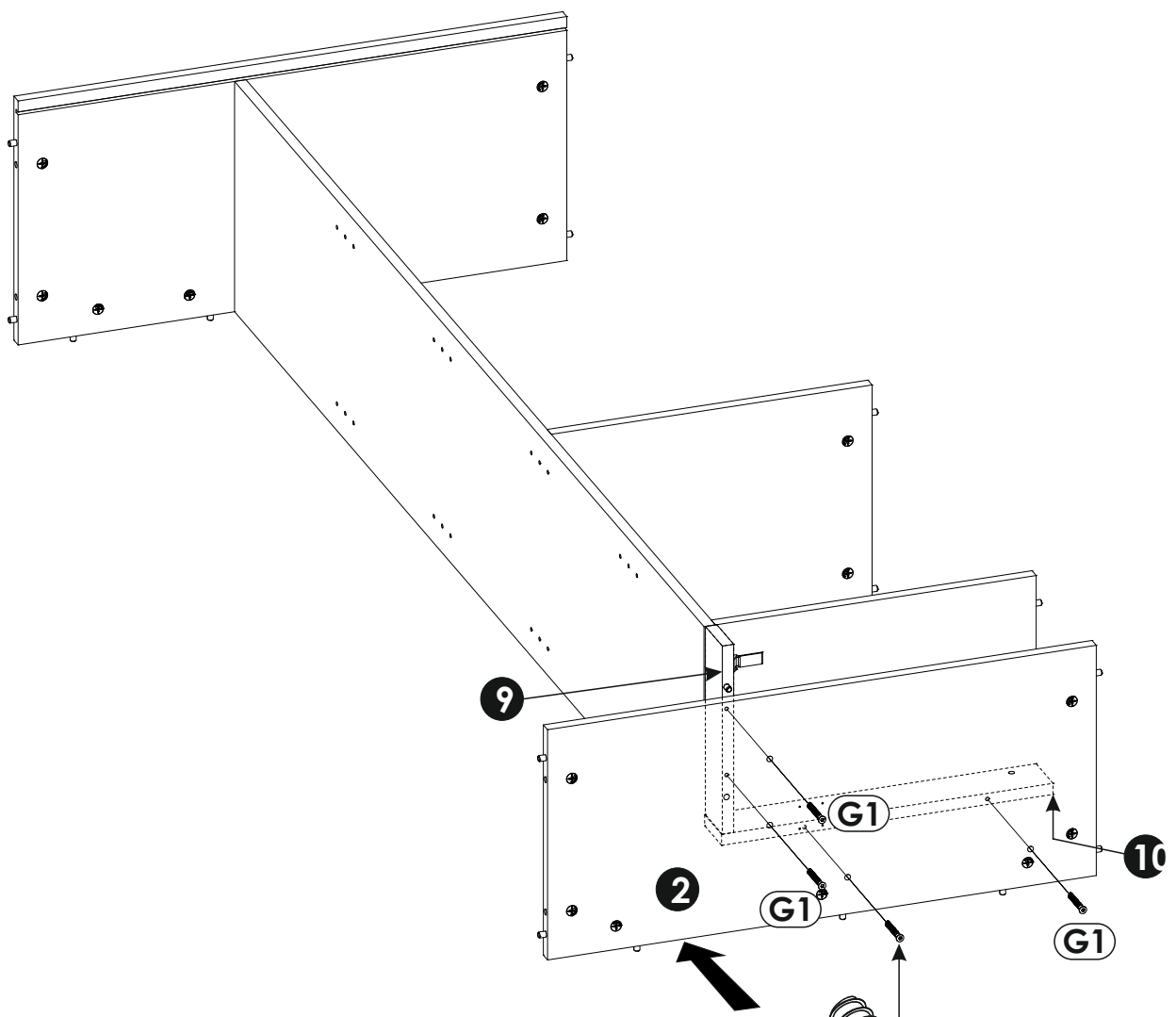
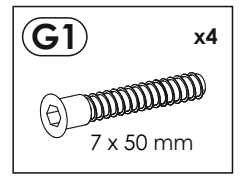
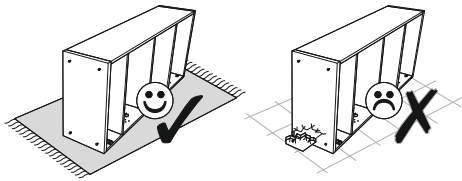

15 ▶

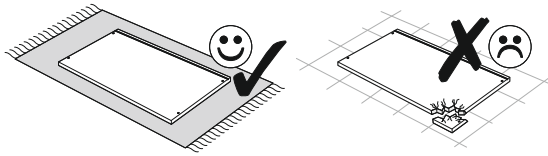



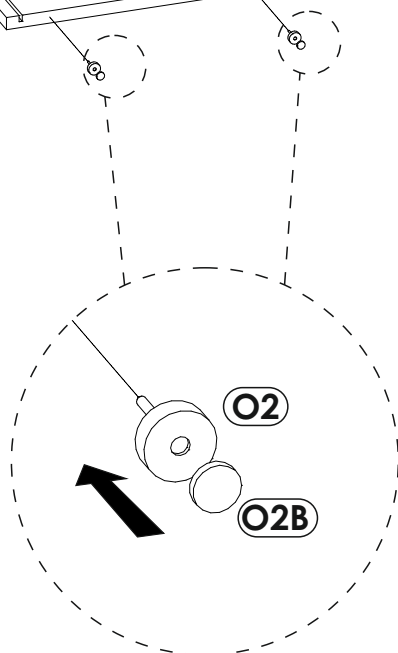
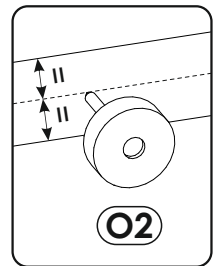
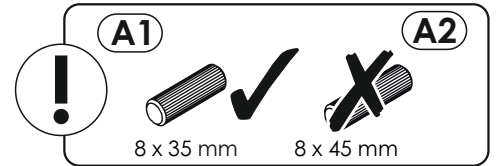
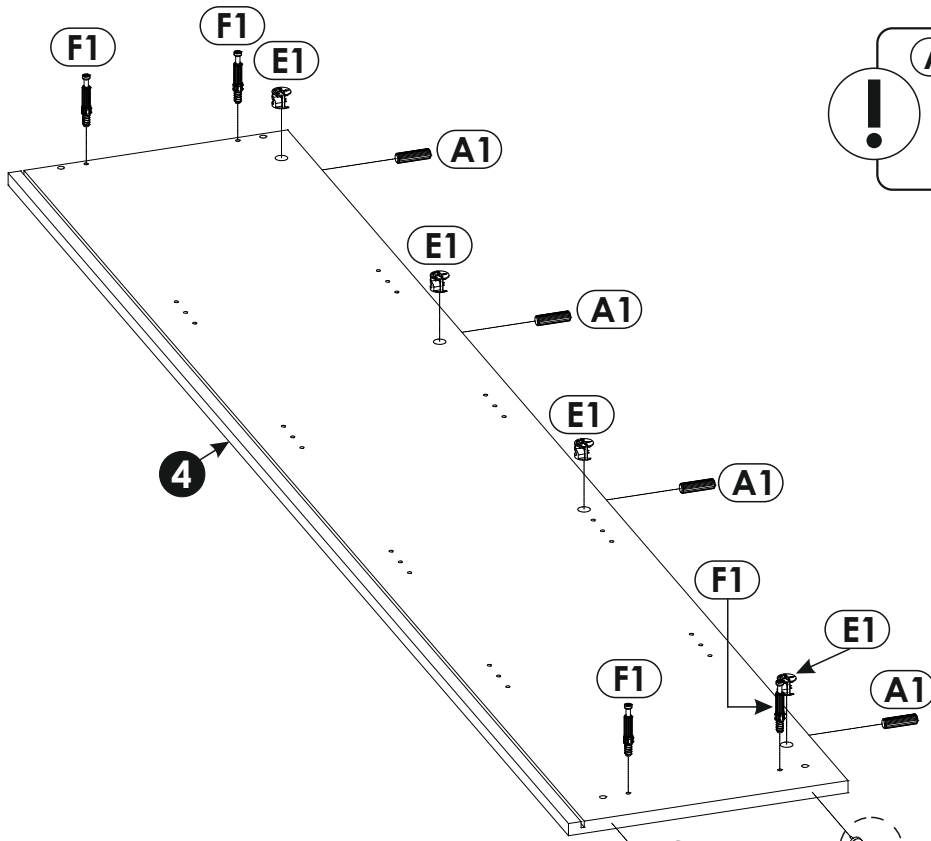

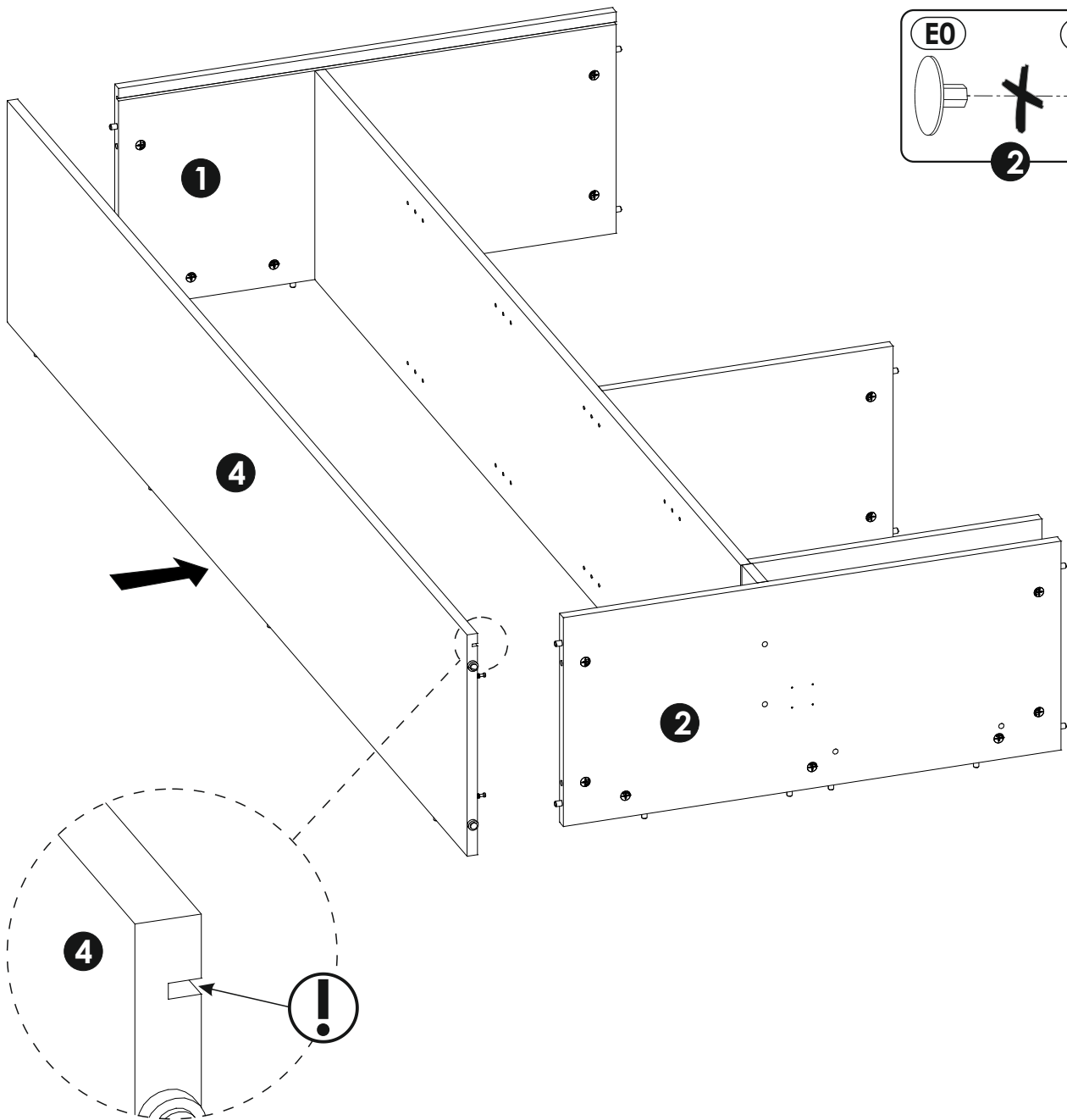
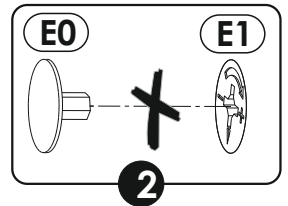
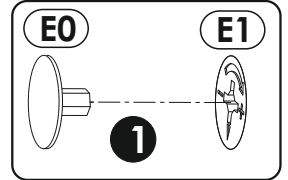
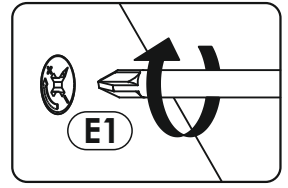
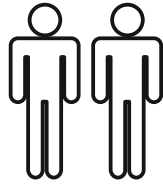
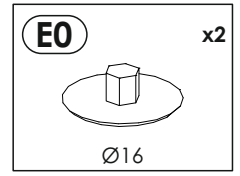
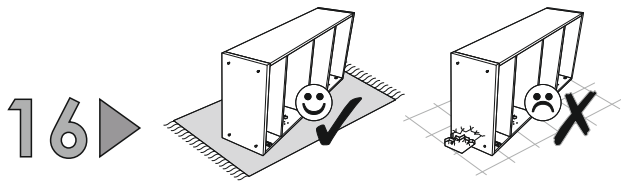
<p>A1 x4</p> <p>8 x 35 mm</p>	<p>E1 x4</p> <p>15 x 12 mm</p>	<p>F1 x4</p> <p>6 x 34 mm</p>
<p>O2 x2</p>	<p>O2B x2</p> <p>ø10</p>	



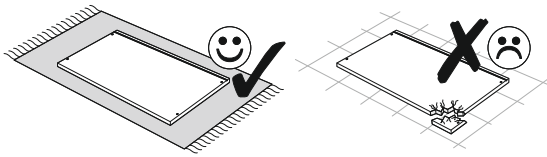

17 ▶

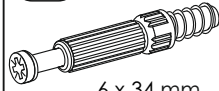
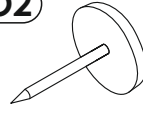

<p>A1 x4</p>  <p>8 x 35 mm</p>	<p>E1 x4</p>  <p>15 x 12 mm</p>	<p>F1 x8</p>  <p>6 x 34 mm</p>	<p>O2 x2</p> 	<p>O2B x2</p>  <p>ø10</p>
--	---	---	---	---

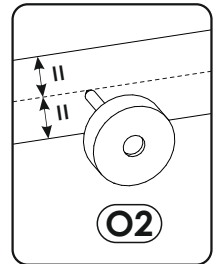
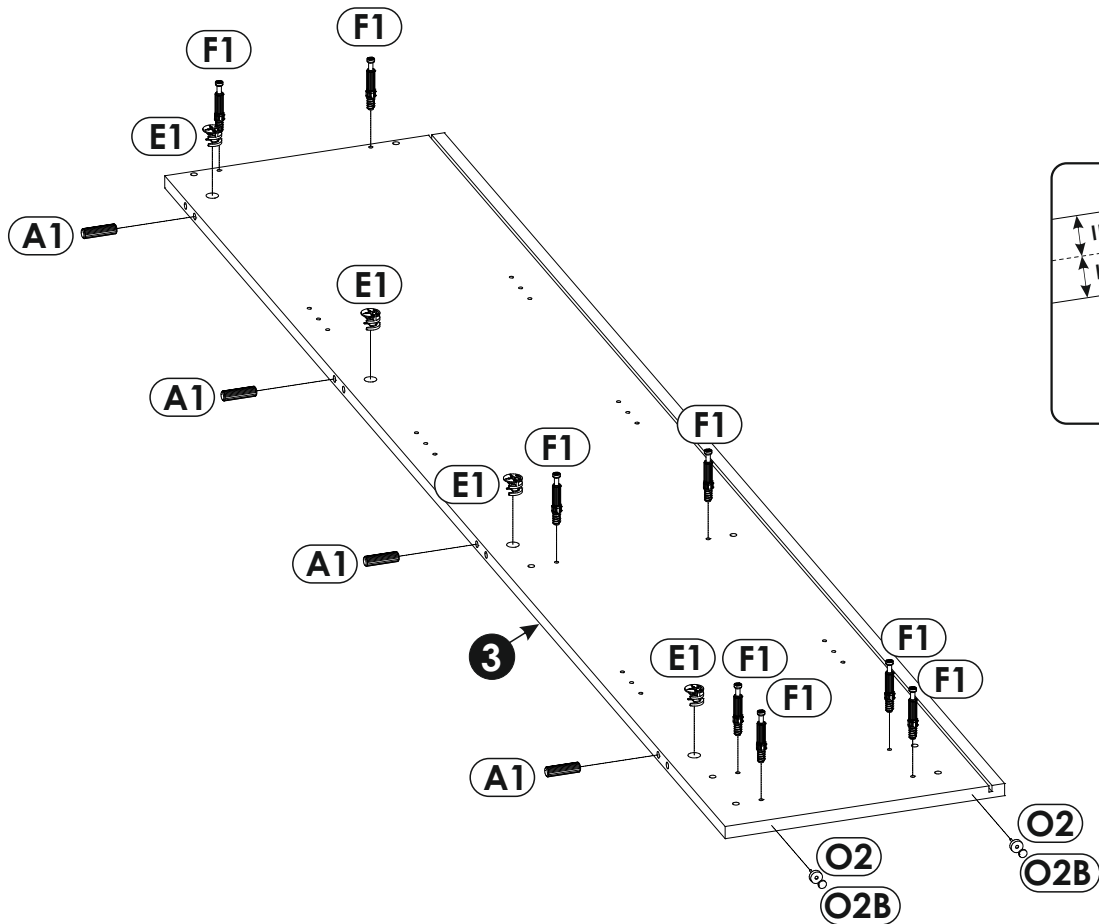
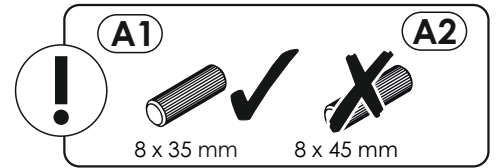

18 ▶

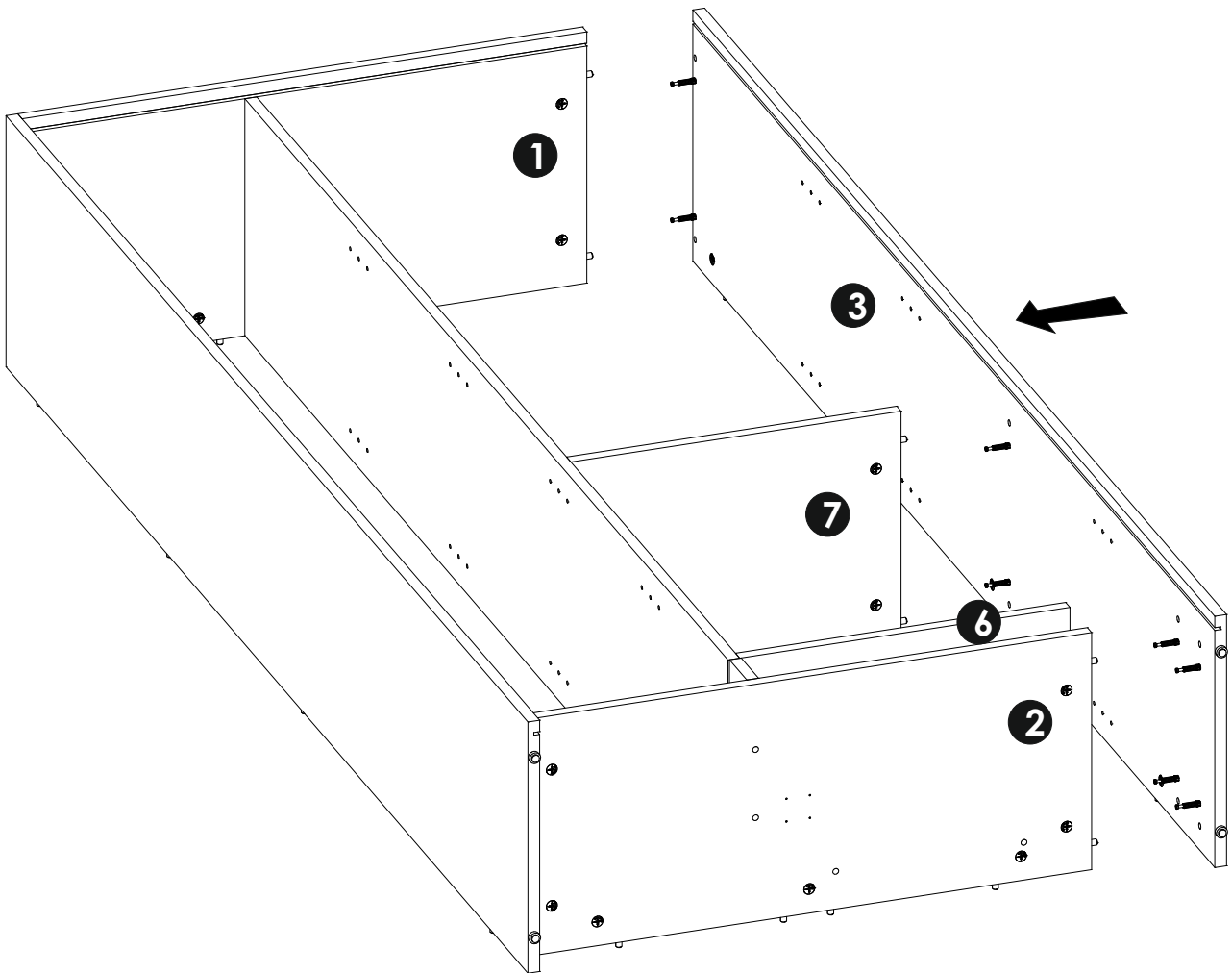
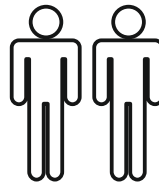
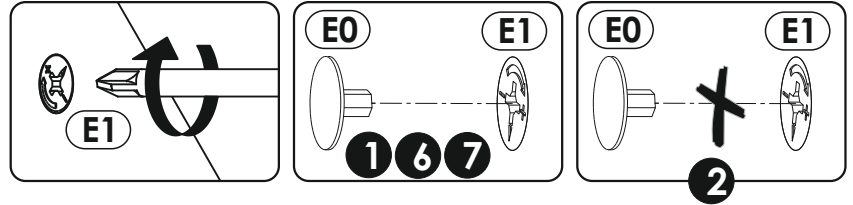
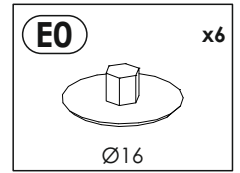
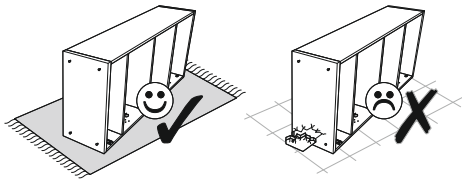

19 ▶

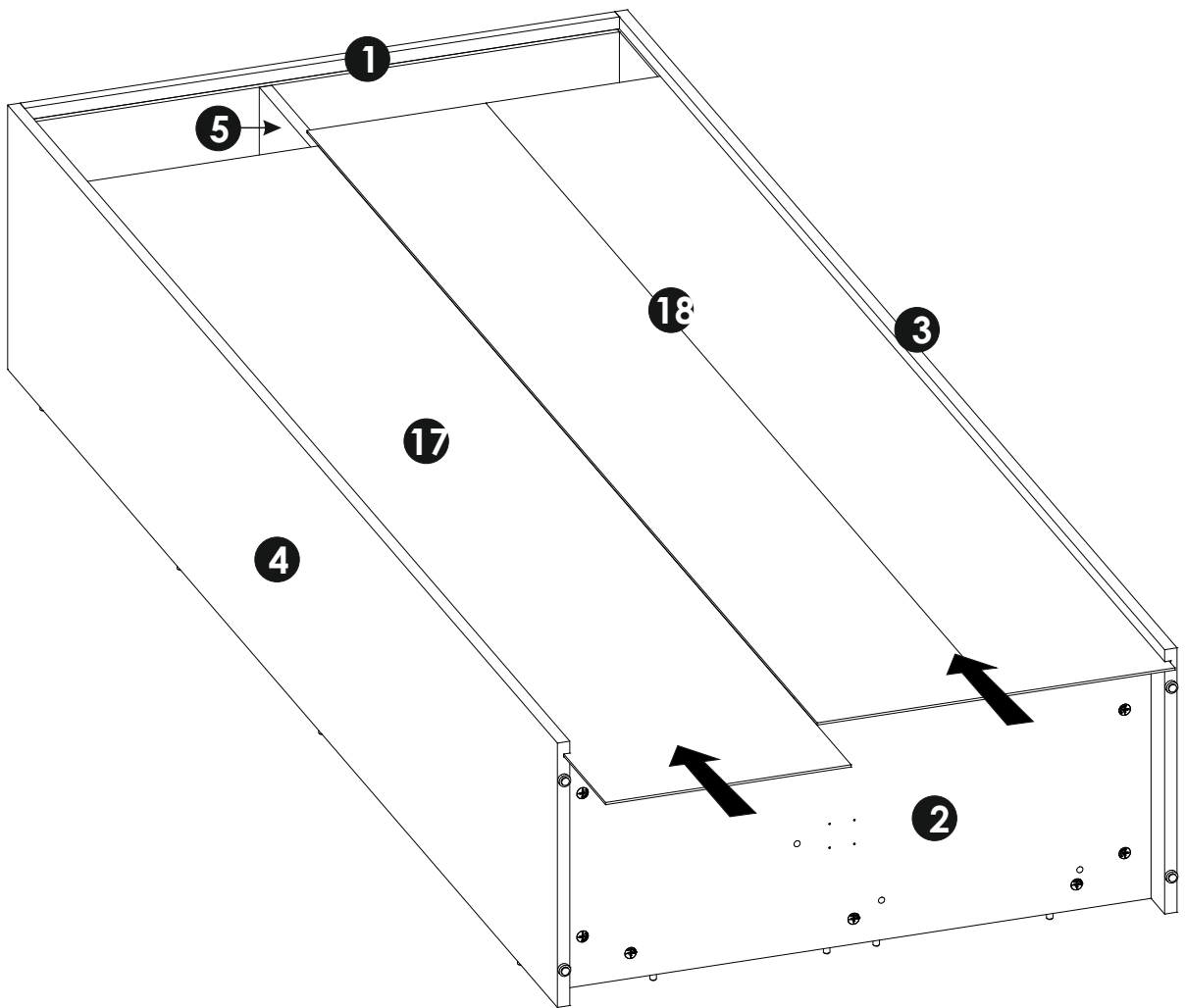
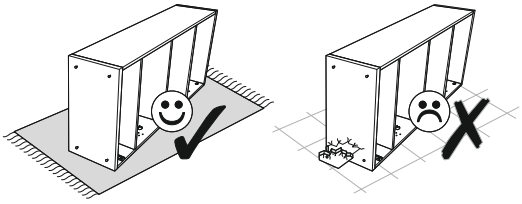

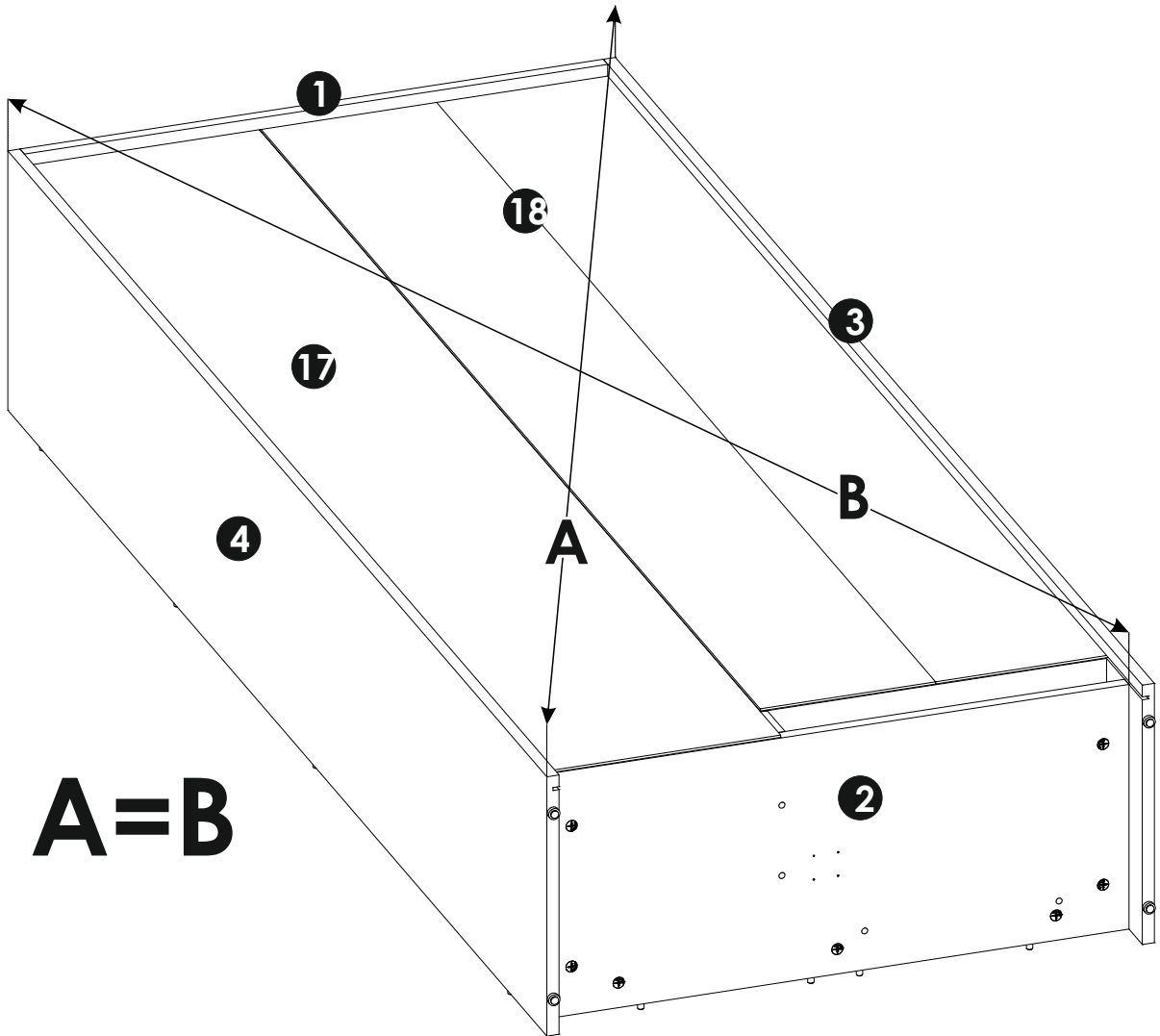
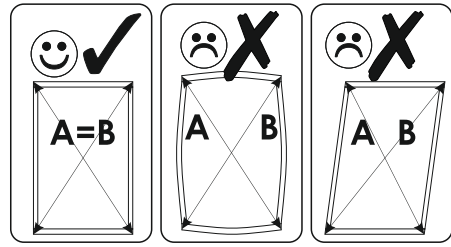
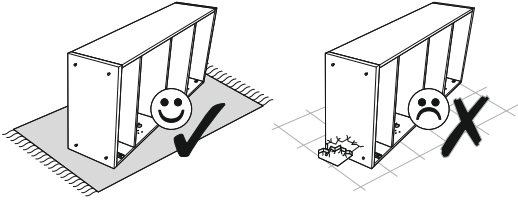

21 ▶

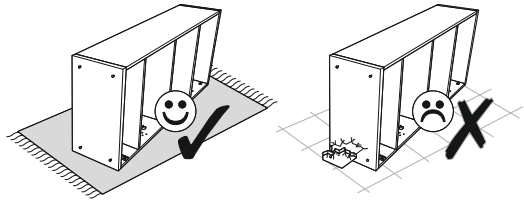

N1 x19 3 x 16 mm	N5 x4 3,5 x 16 mm	O8 x1
R1 x12	R4 x12	O2B x2 ø10

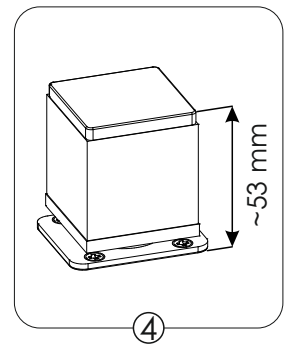
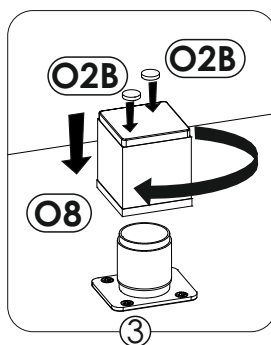
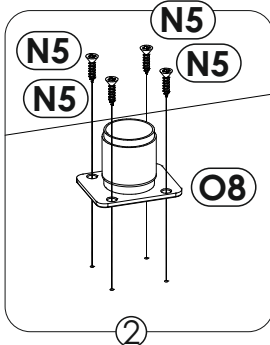
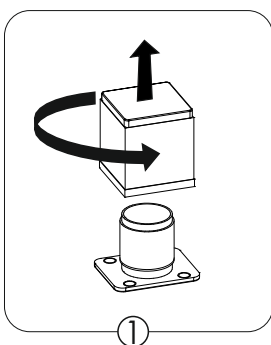
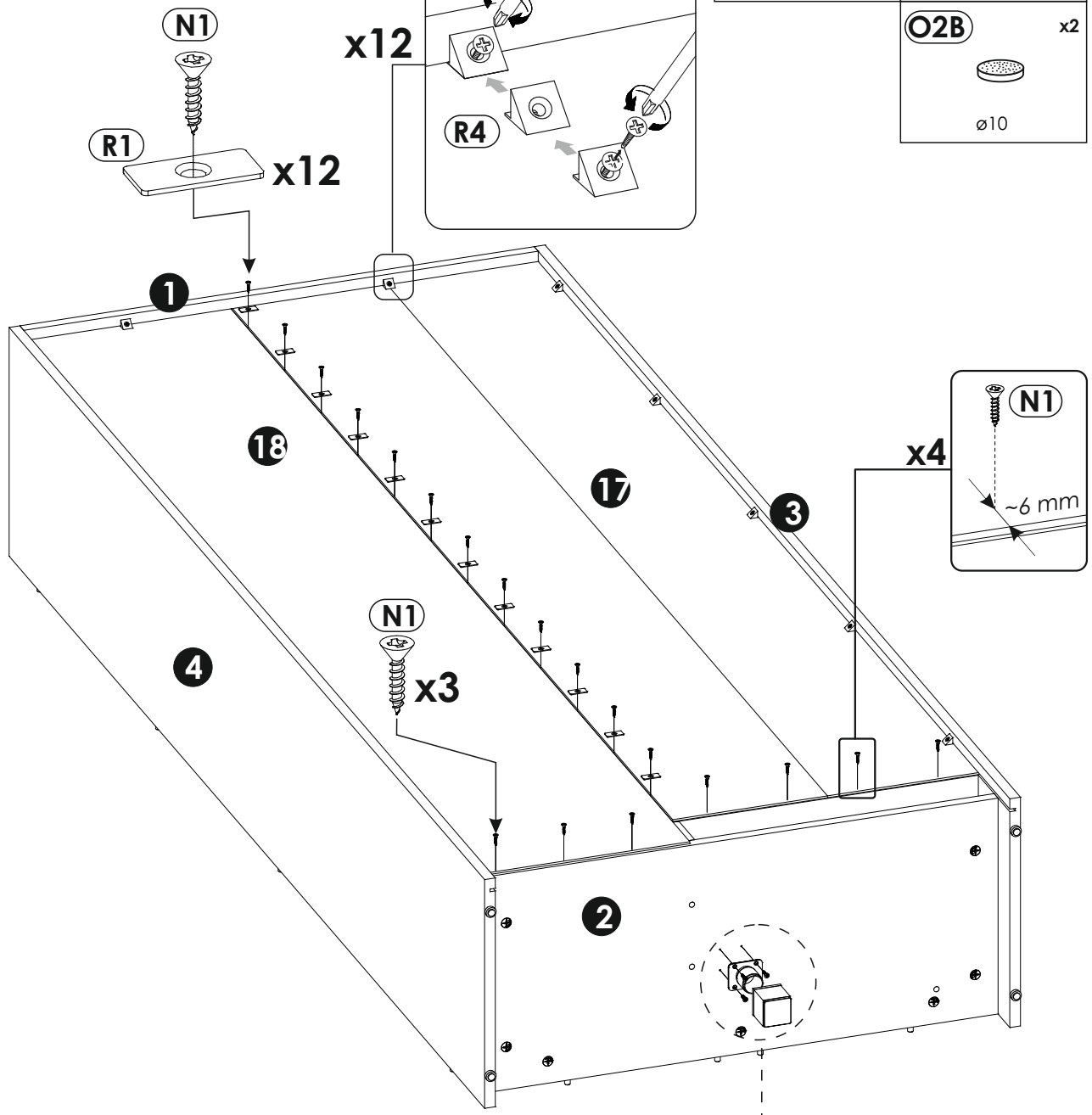

22 ▶

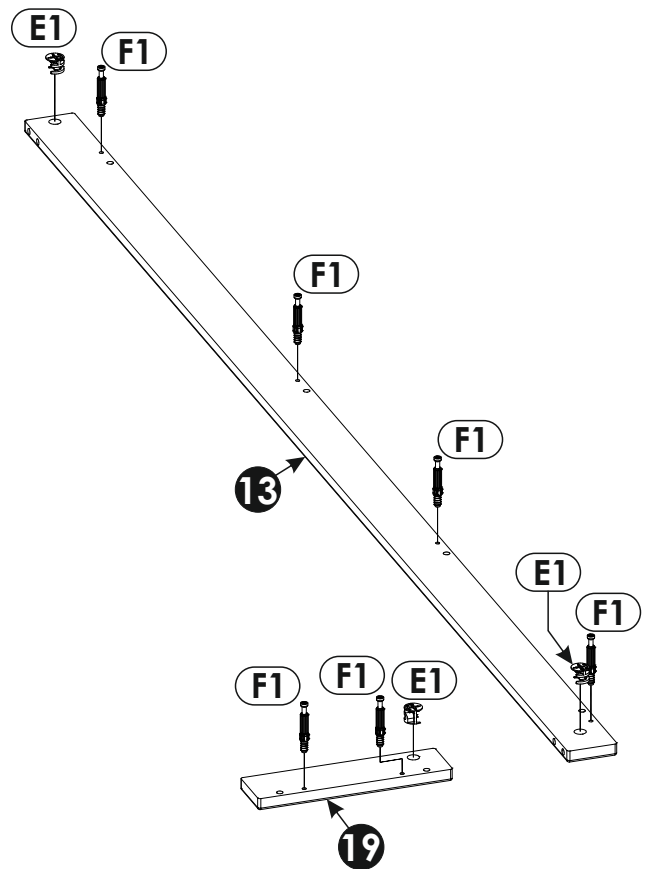
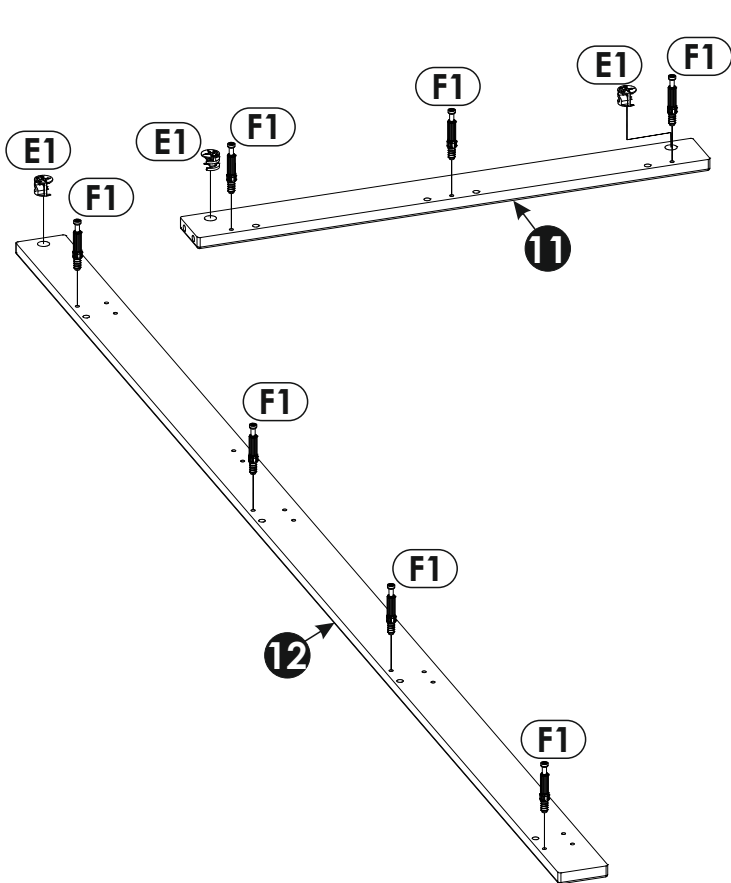
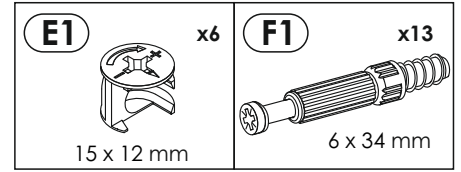
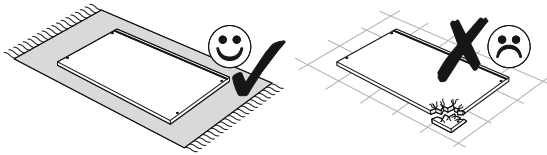

23 ▶

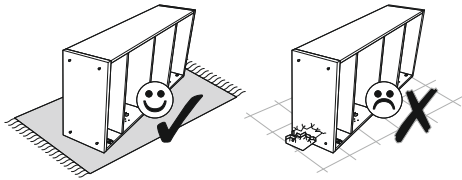

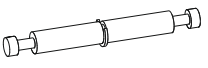
A2	x3	F3	x3
			
8 x 45 mm		7 x 64 mm	

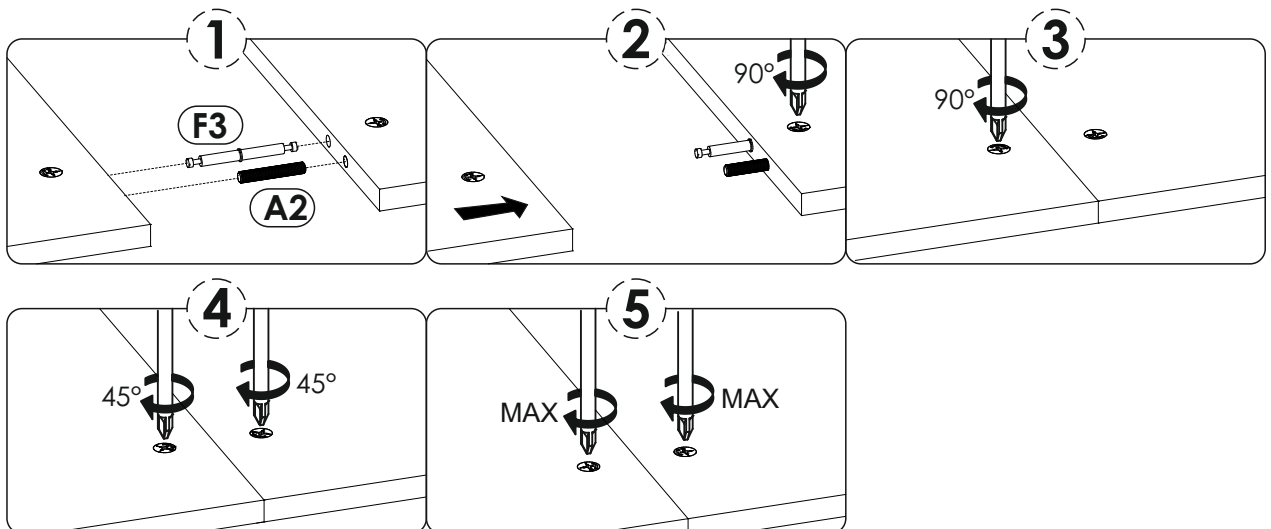
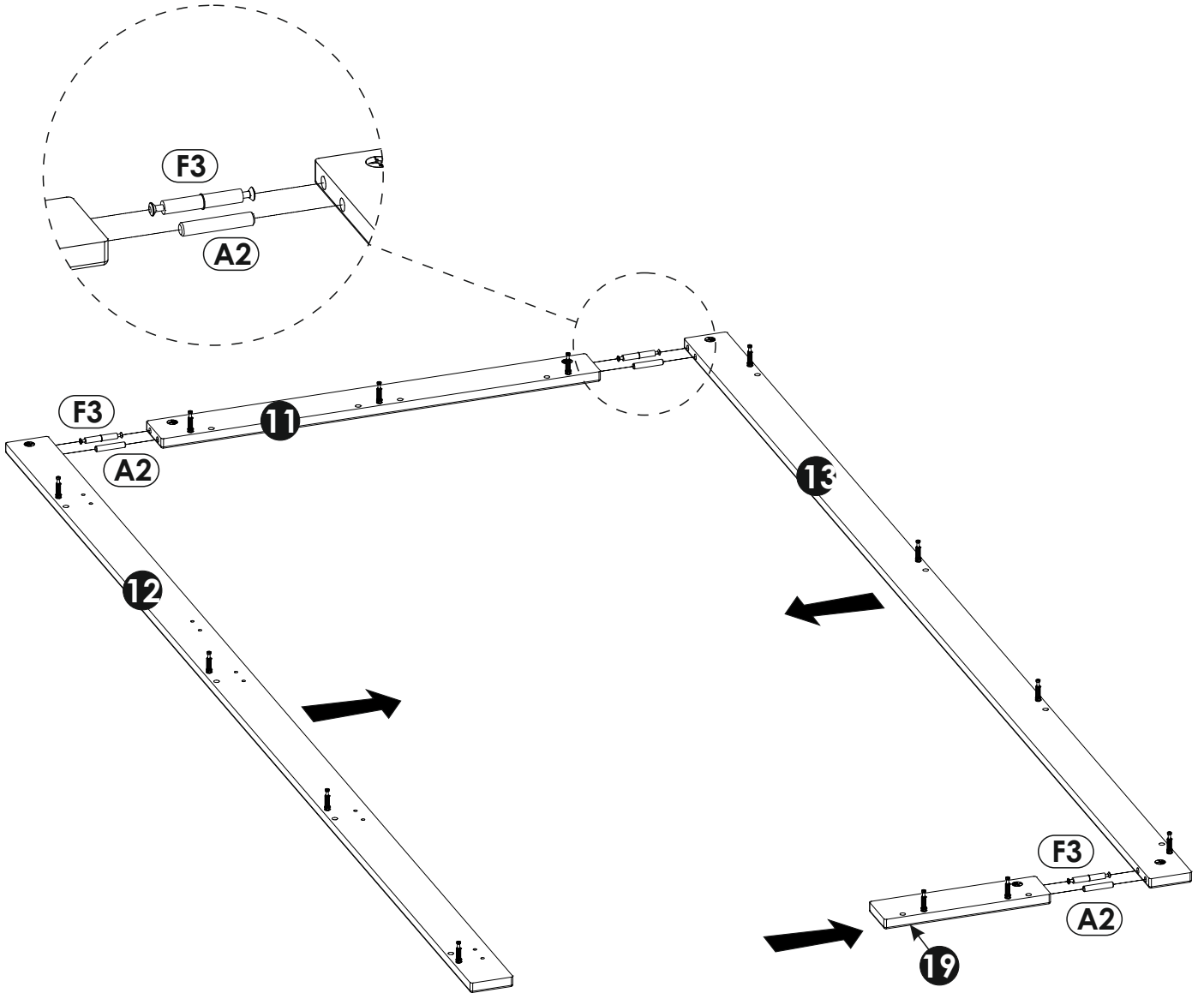

24 ▶

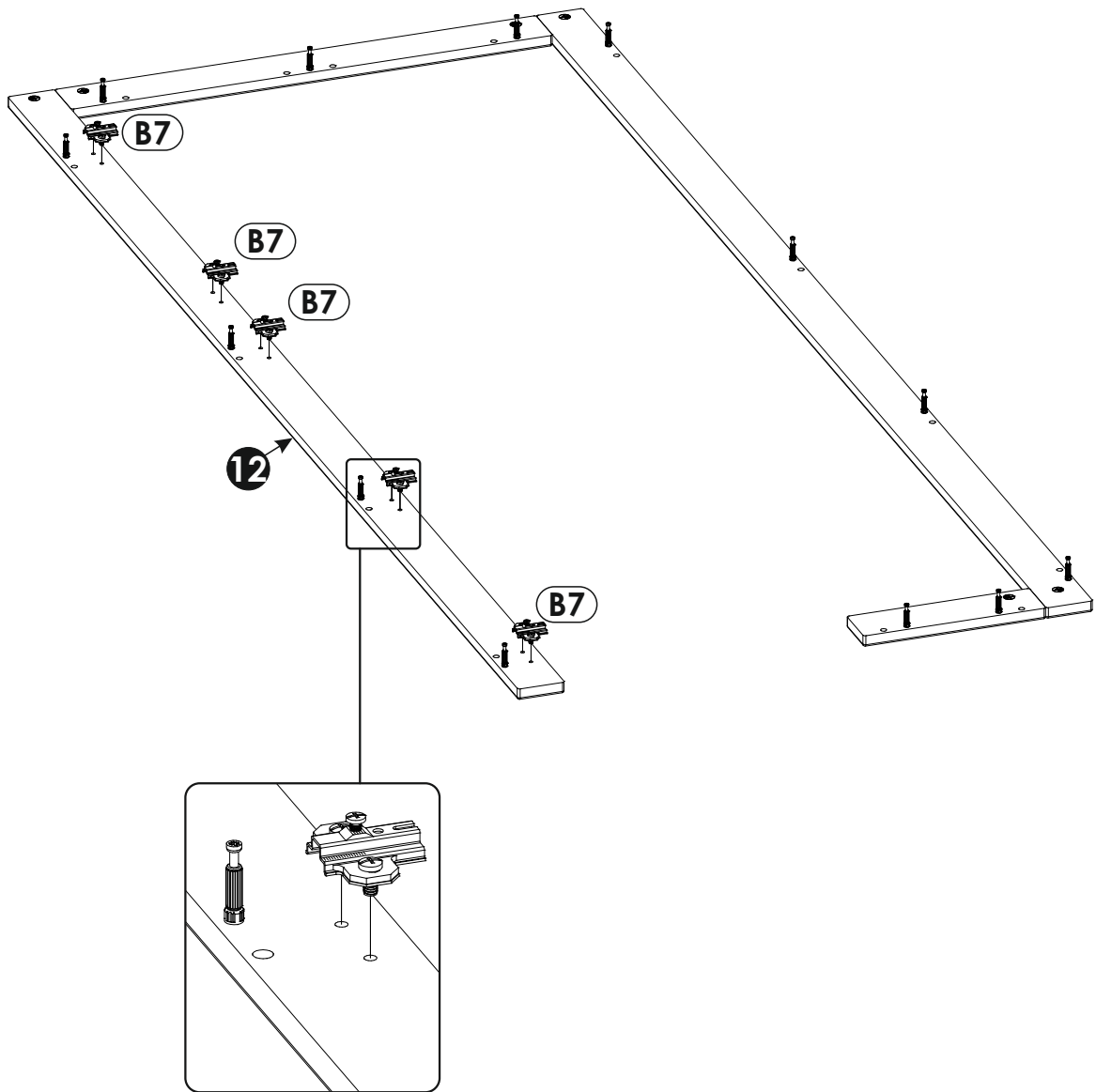
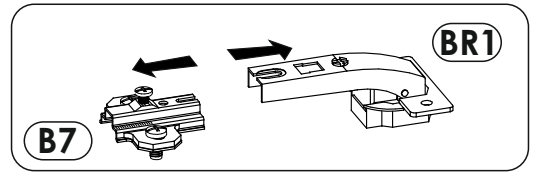
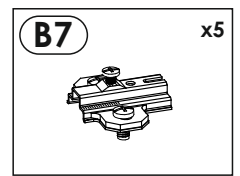
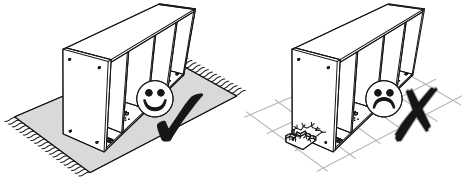

25 ▶

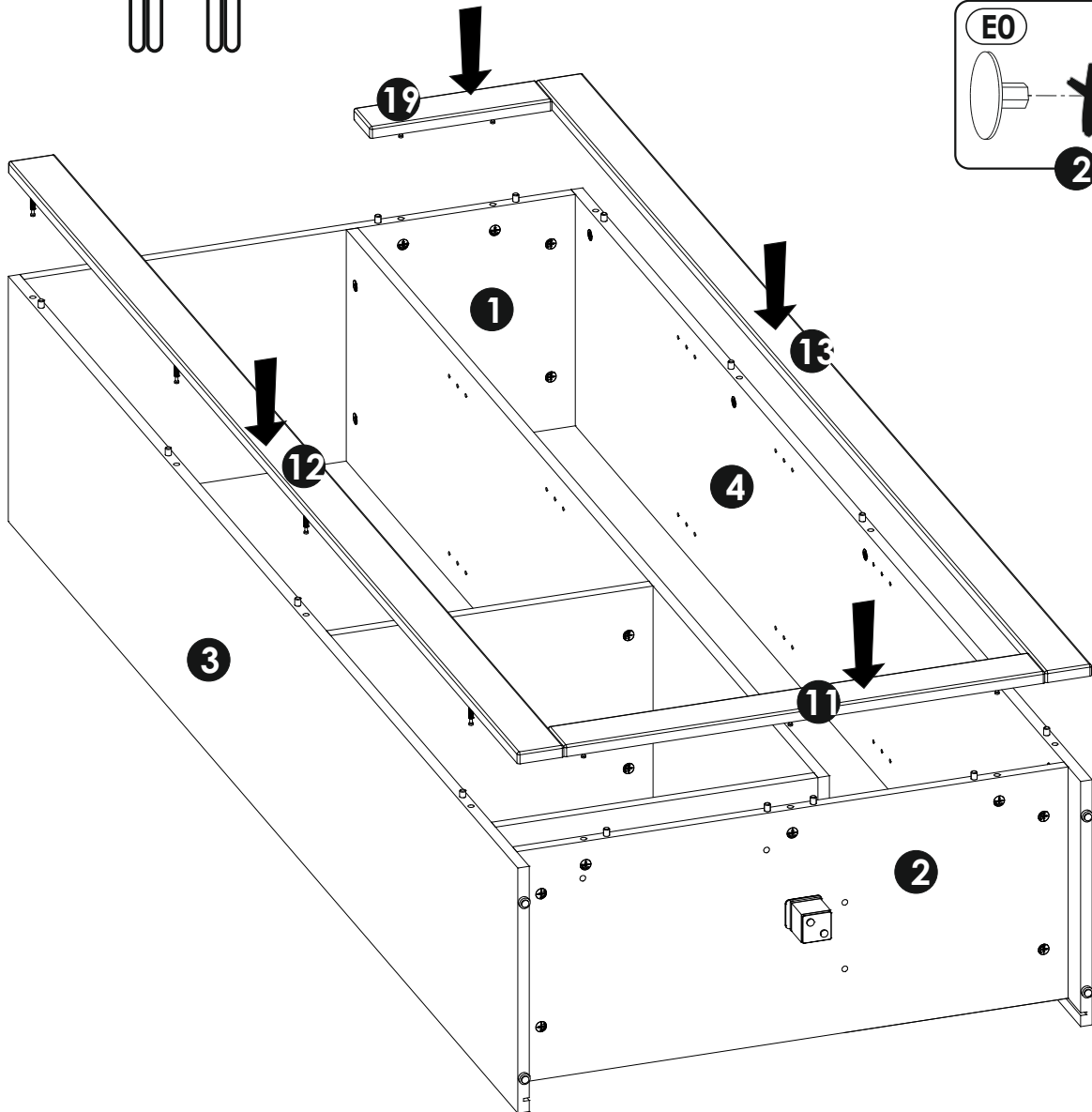
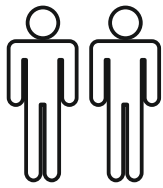
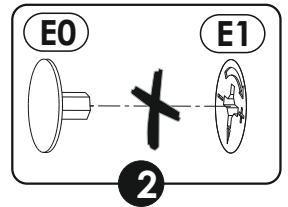
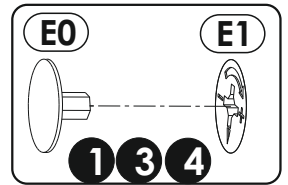
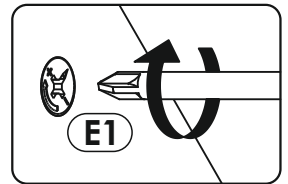
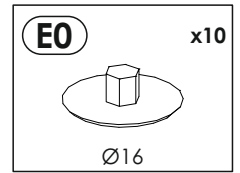
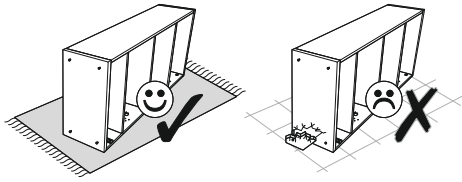

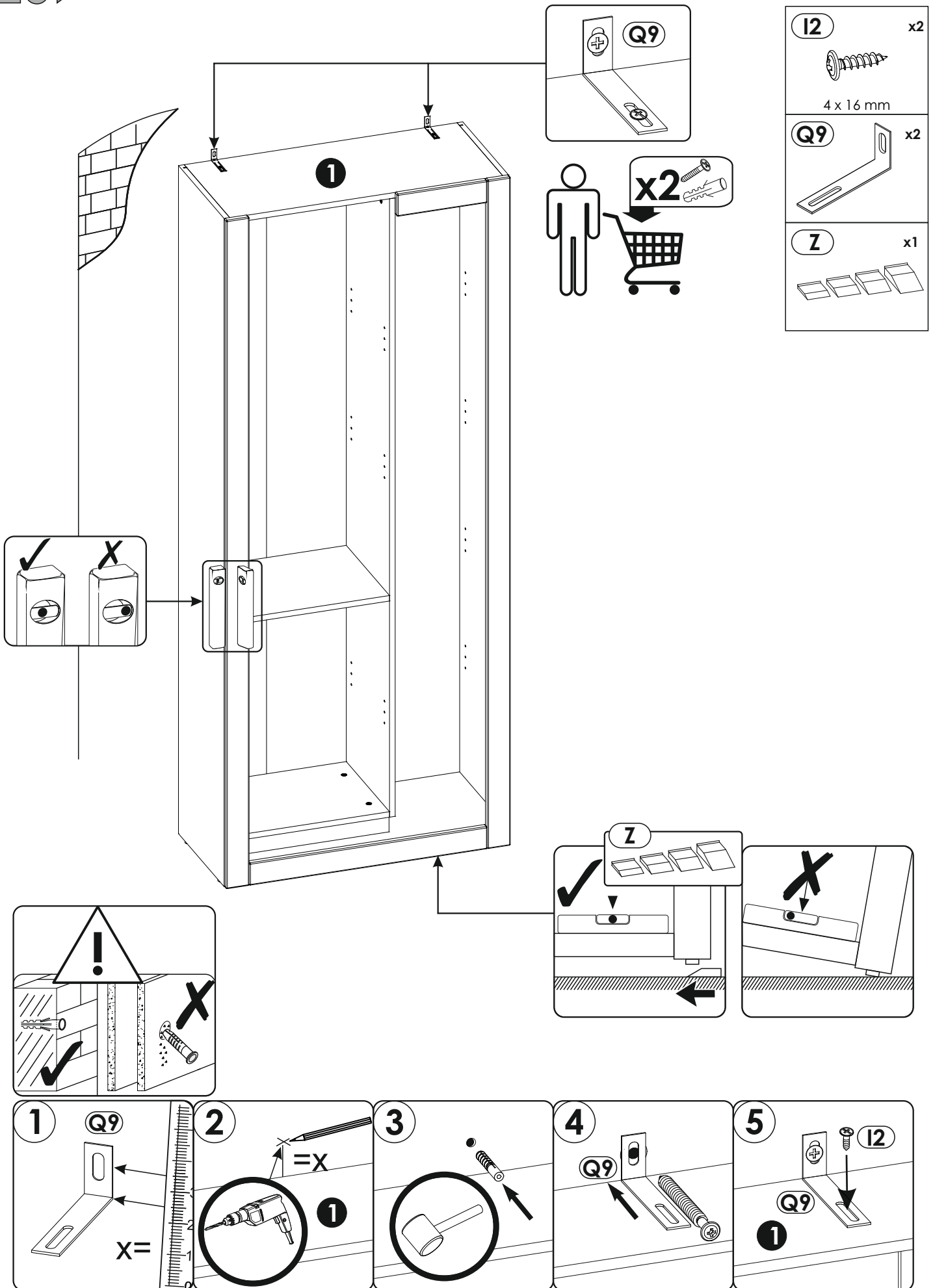

27 ▶

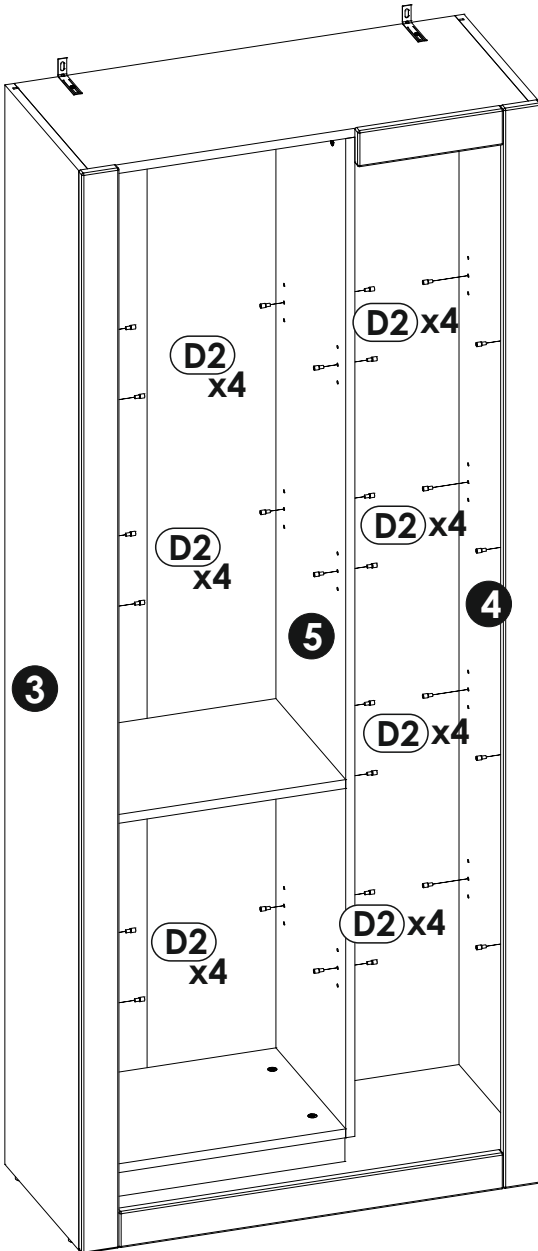
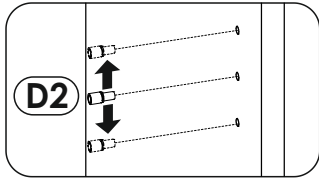
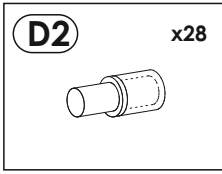

28 ▶

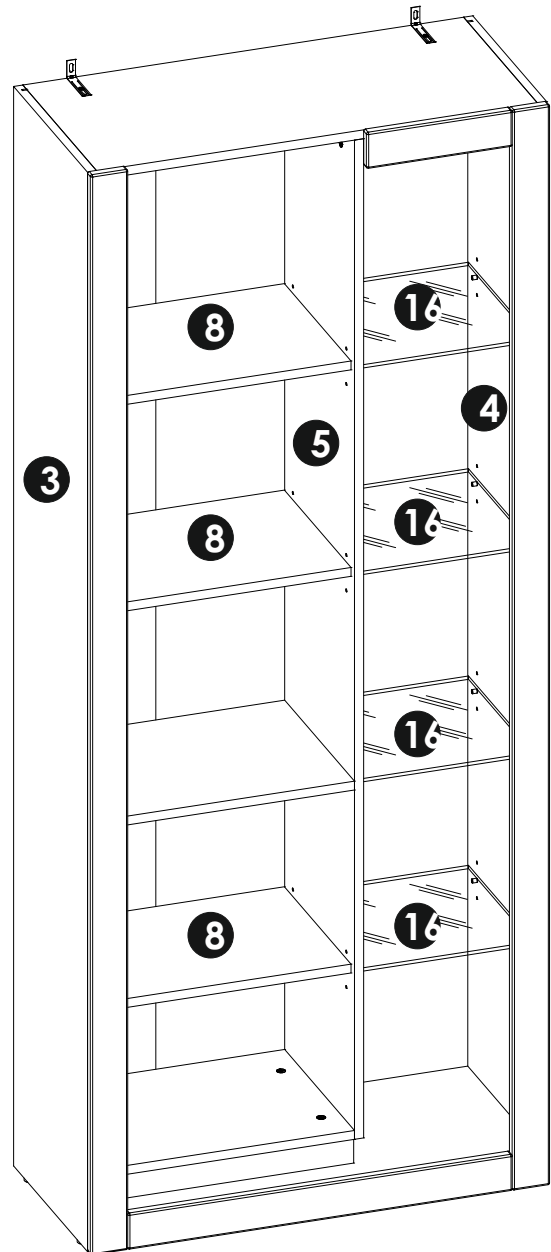
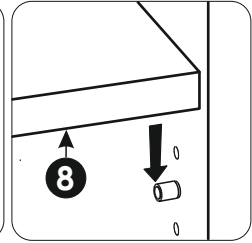
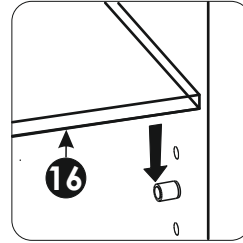

29 ▶

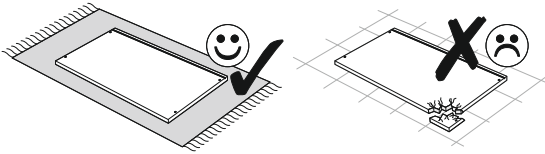

BR1 x3	C2 x6 5 x 13 mm	R8 x2
---------------	---------------------------	--------------

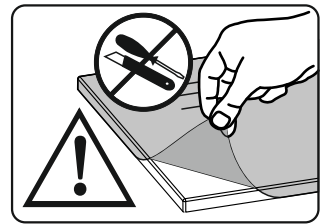
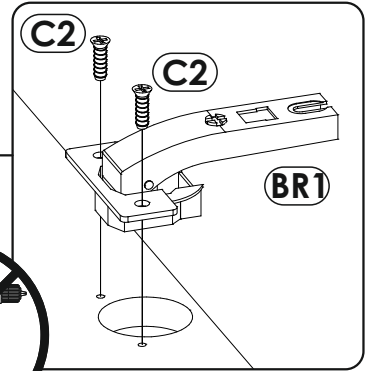
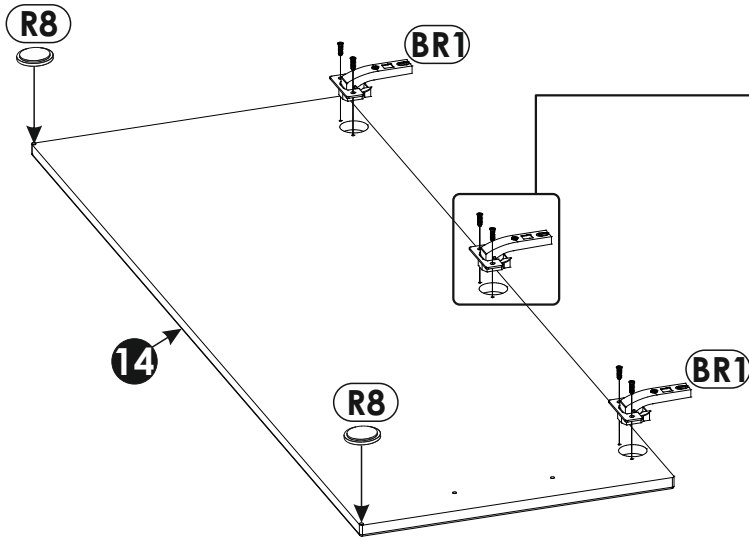
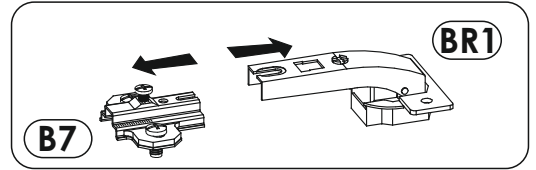
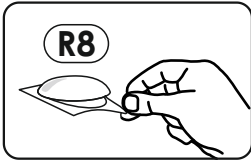

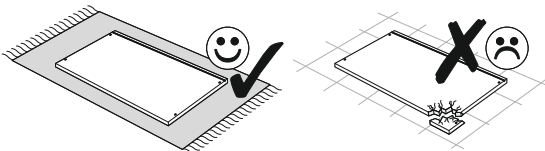

30 ▶

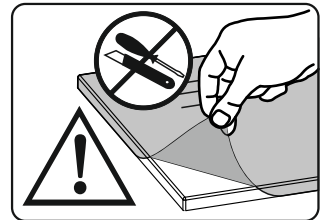
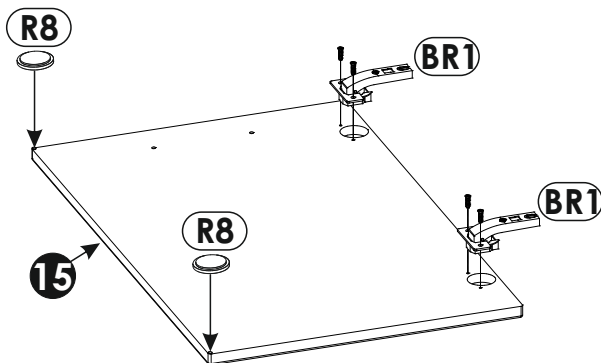
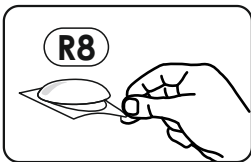

BR1 x2	C2 x4 5 x 13 mm	R8 x2
---------------	---------------------------	--------------

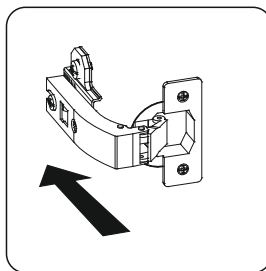
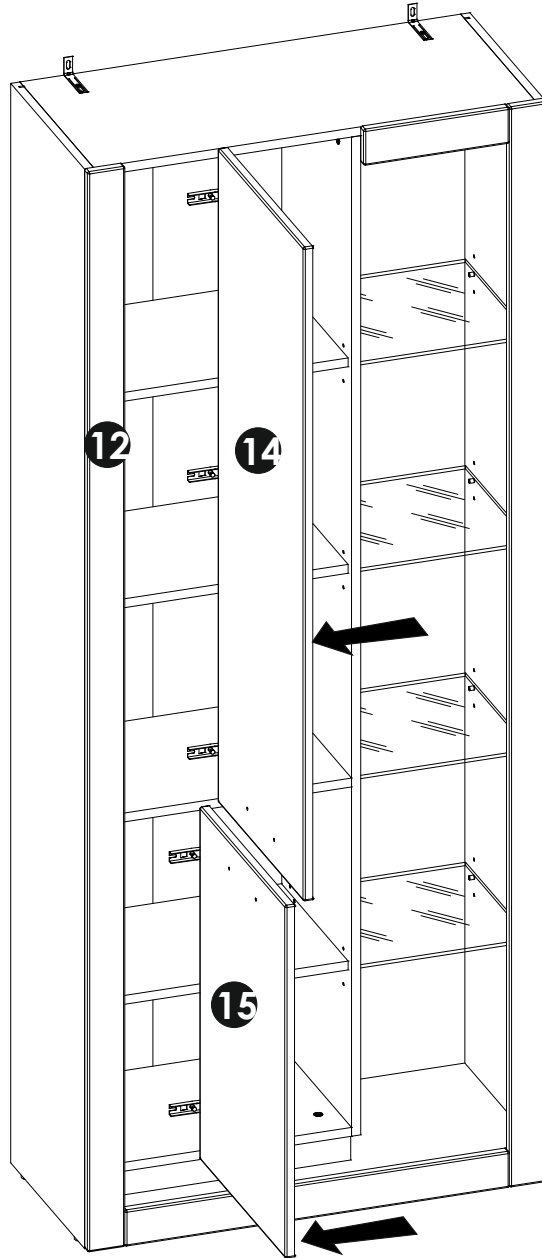

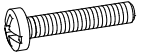

H1	x2	K7	x4
			
L - 150 mm		4 x 22 mm	

