

A**S643-SZU/38/32/A****CONNECT**

24270215/53
24270215/54

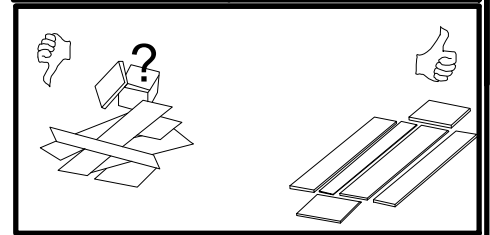

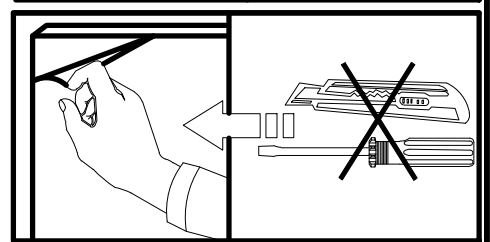
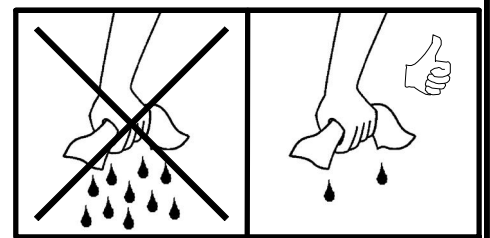
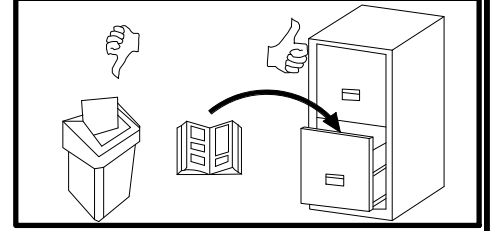
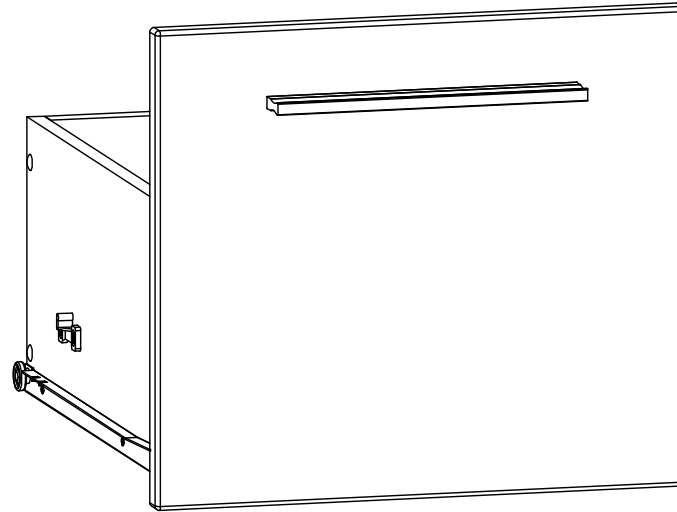
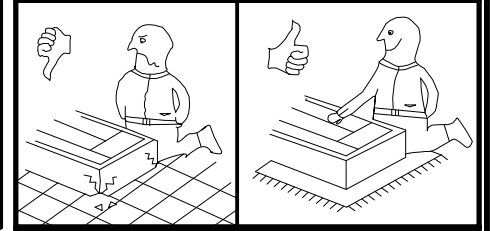
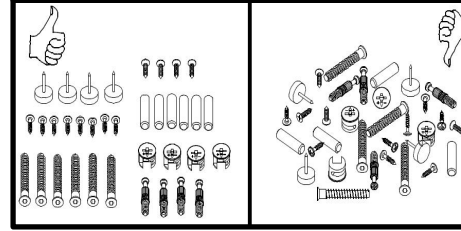
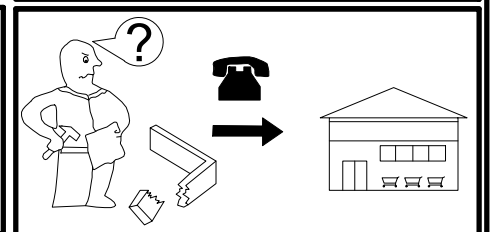
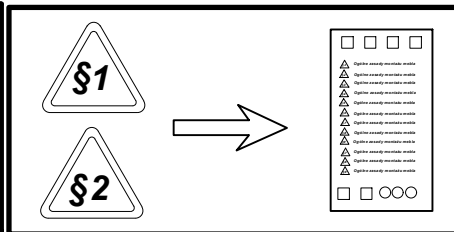
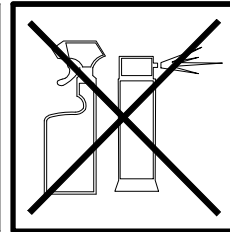
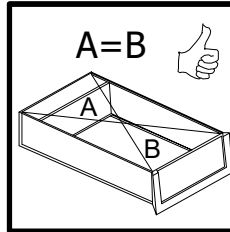
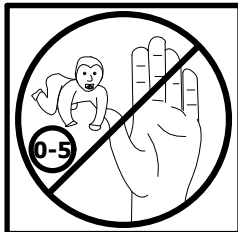
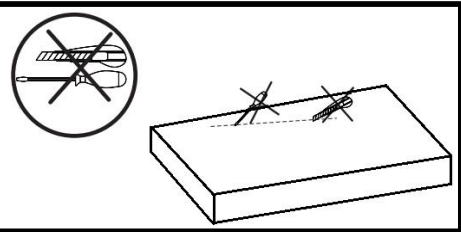
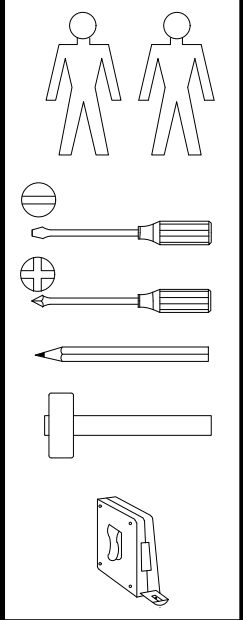

20 min

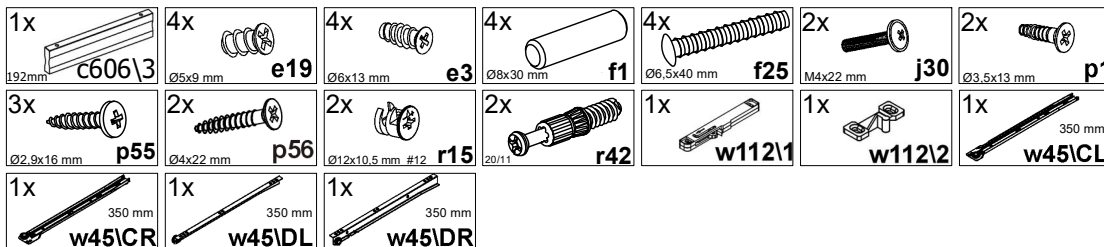

A	B1	B2	C1	C2	C3	D
1	S643-0012	-	364	322	16	1/1
2	S643-5008	-	350	180	12	1/1
3	S643-5010	-	350	180	12	1/1
4	STR-5107	-	321	180	15	1/1
5	WDF-9104	-	343	358	2,5	1/1

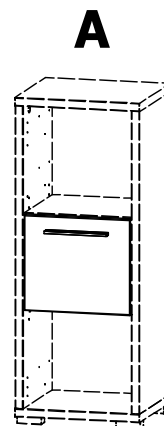

S643-REG/110/43

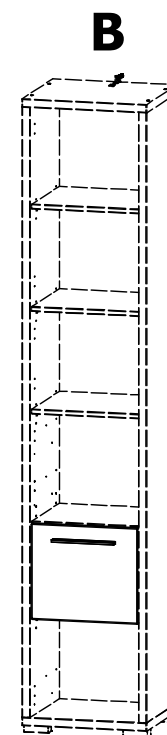

S643-REG/213/43

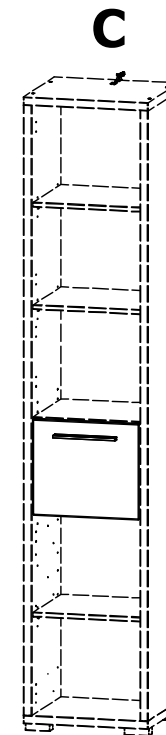

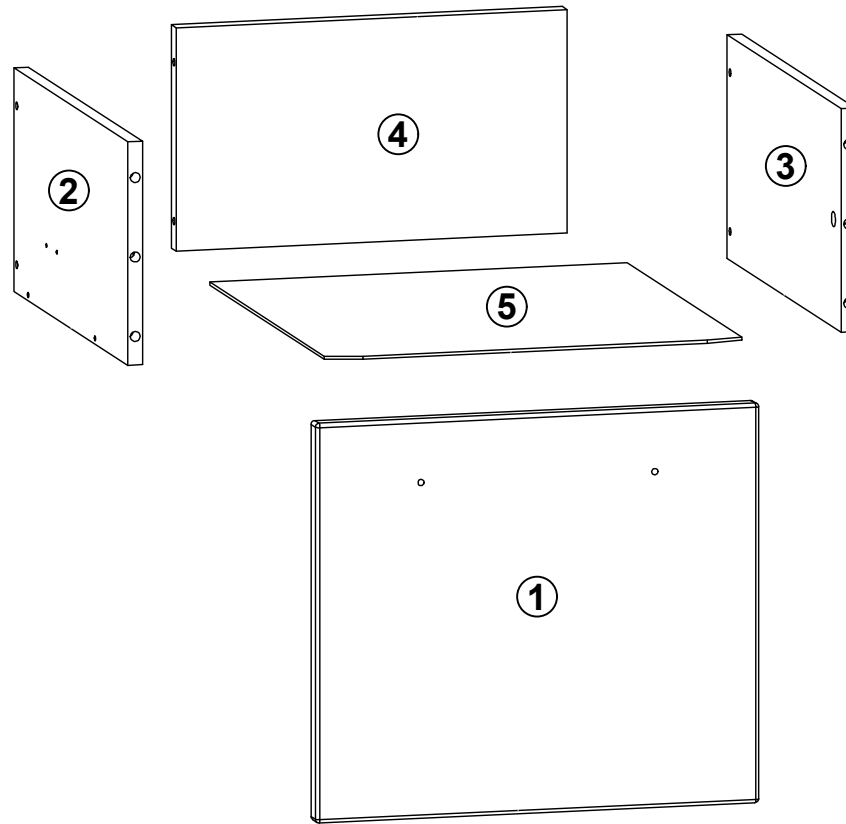

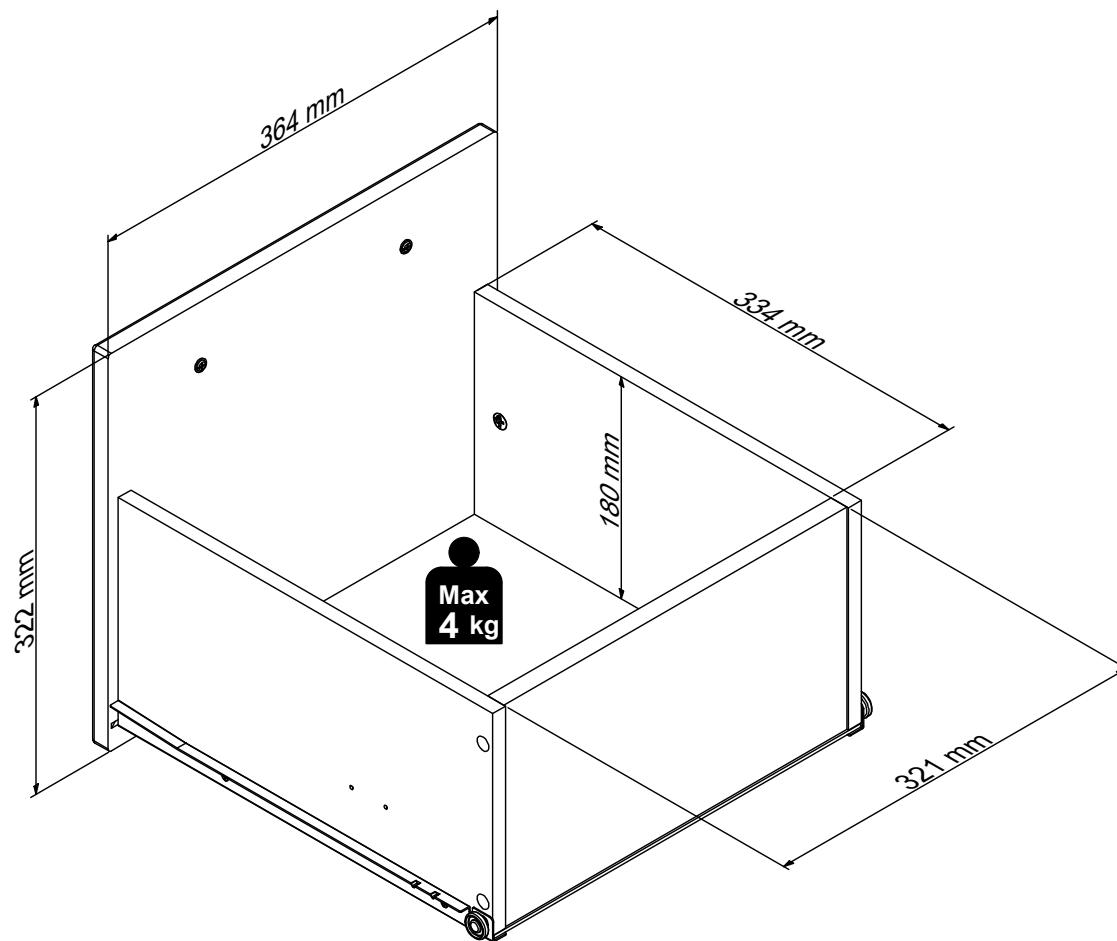

- 1x 192mm c606\3
- 4x Ø5x9 mm e19
- 4x Ø8x30 mm f1
- 4x Ø6,5x40 mm f25
- 2x M4x22 mm j30
- 2x Ø3,5x13 mm p1
- 3x Ø2,9x16 mm p55
- 2x Ø12x10,5 mm #12 r15
- 2x 20/11 r42
- 1x w112\2
- 1x 350 mm w45\DL
- 1x 350 mm w45\DR

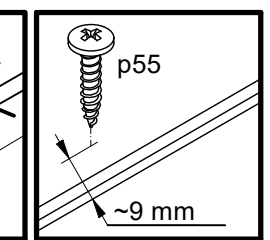
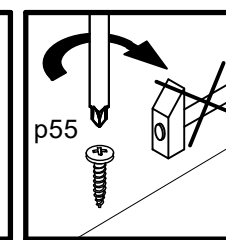
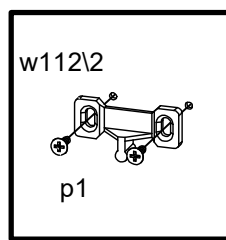
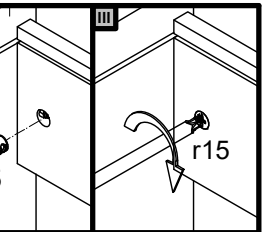
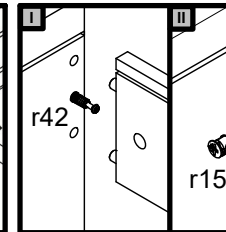
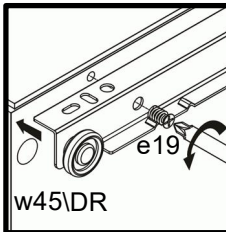
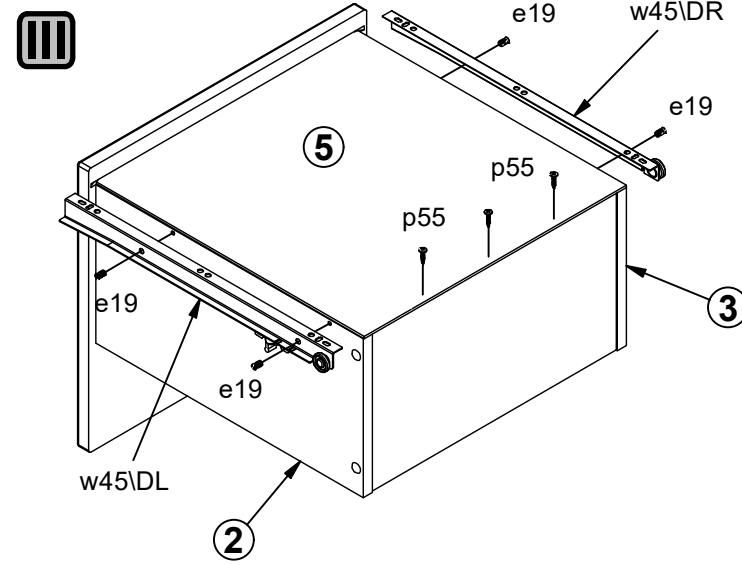
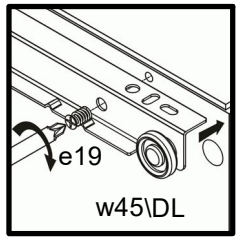
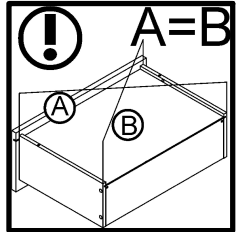
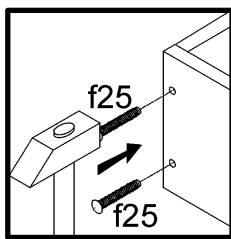
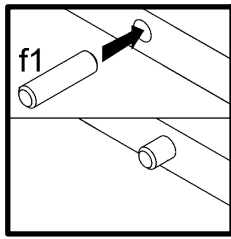
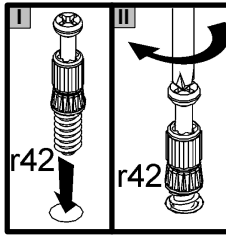
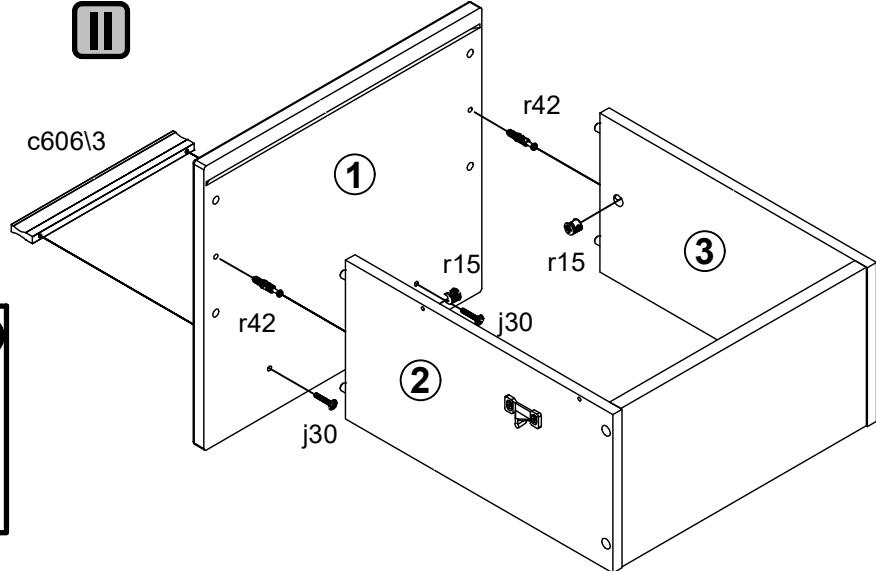
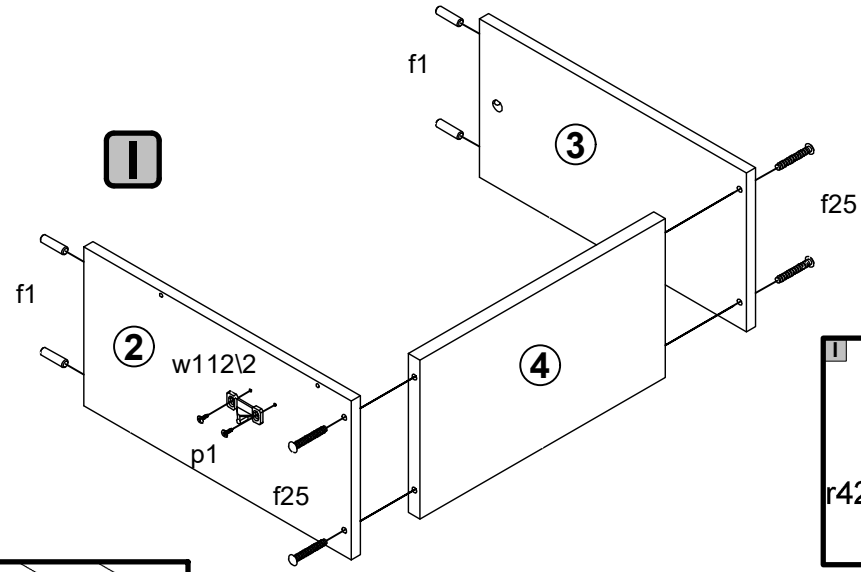

2A

- 4x Ø6x13 mm e3
- 2x Ø4x22 mm p56
- 1x w112\1
- 1x 350 mm w45\CL
- 1x 350 mm w45\CR

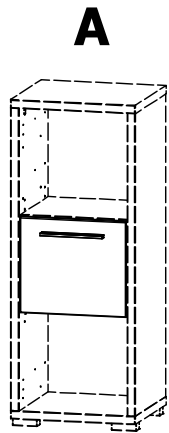
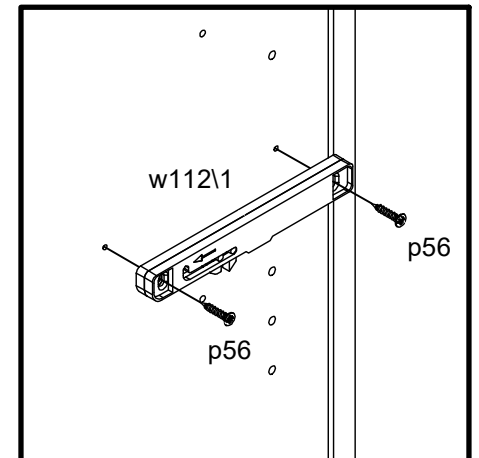
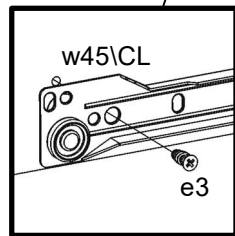
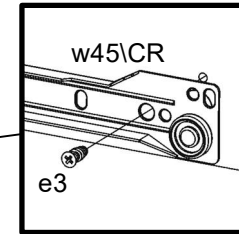
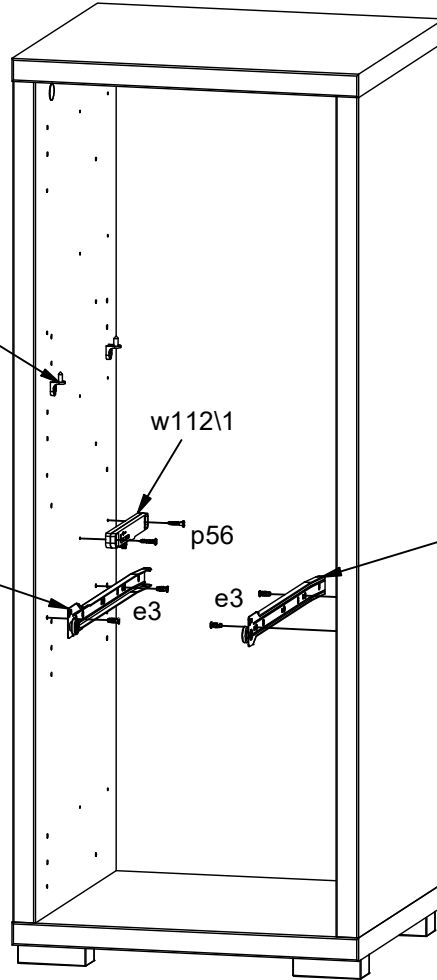
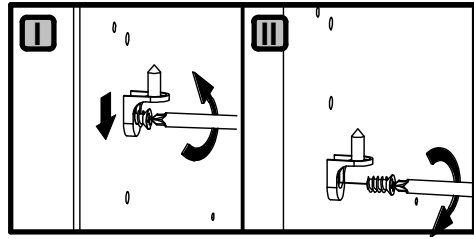

S643-REG/110/43

3A

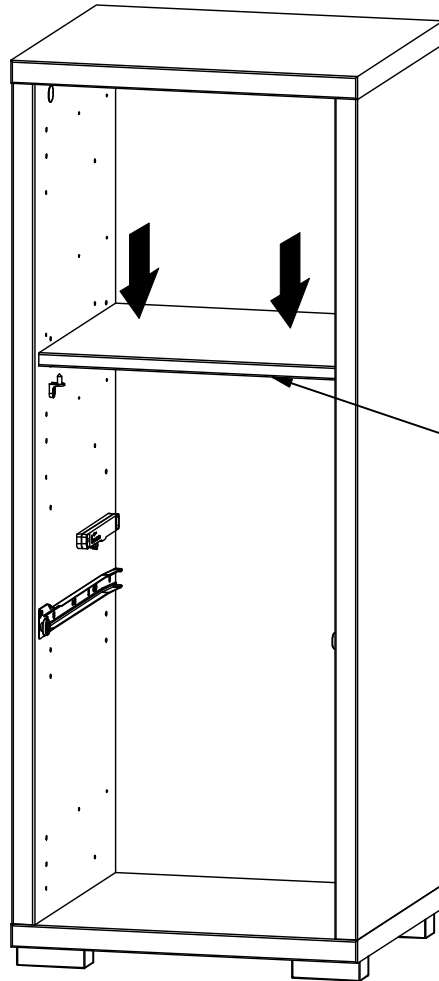

4A

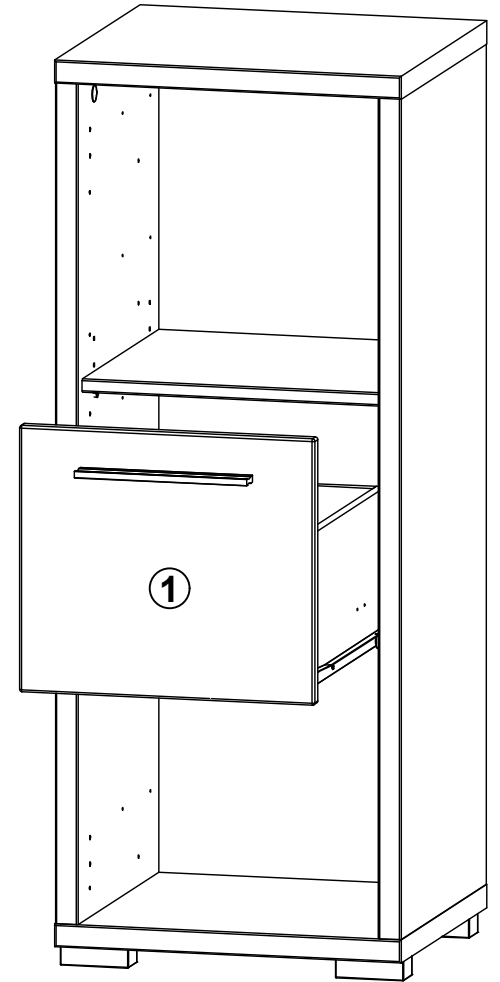
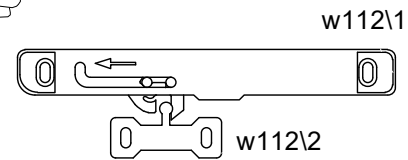
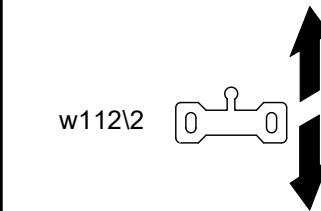
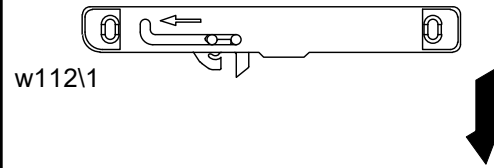

2B

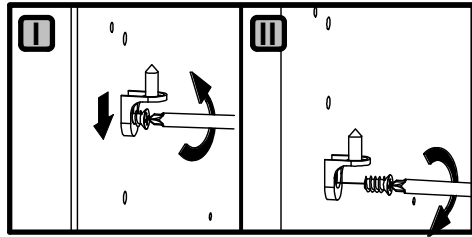
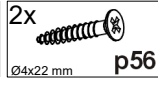
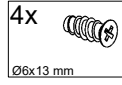

B

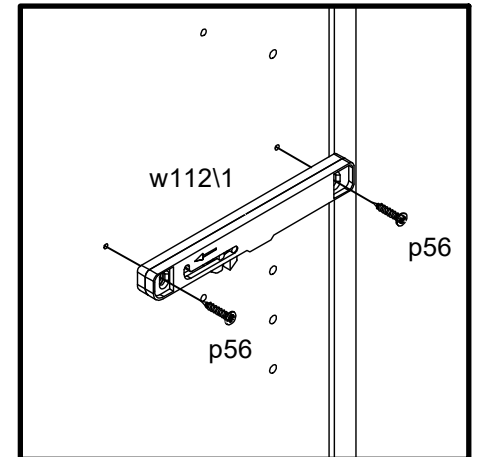
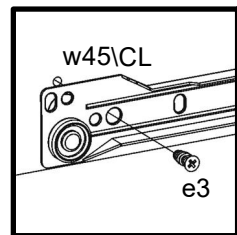
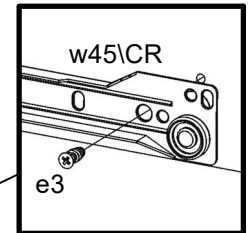
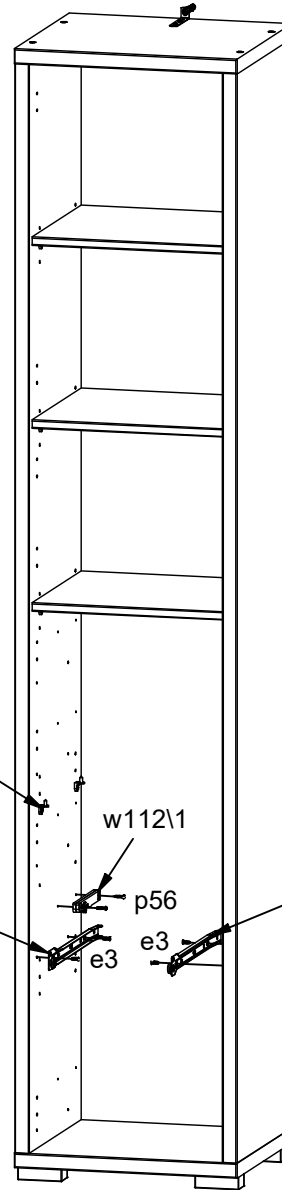
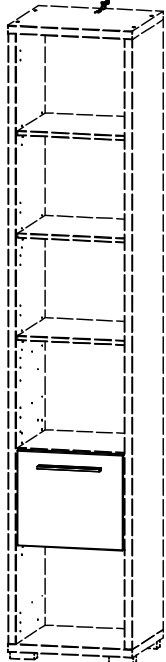

S643-REG/213/43

3B

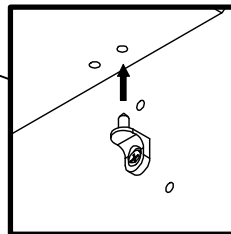
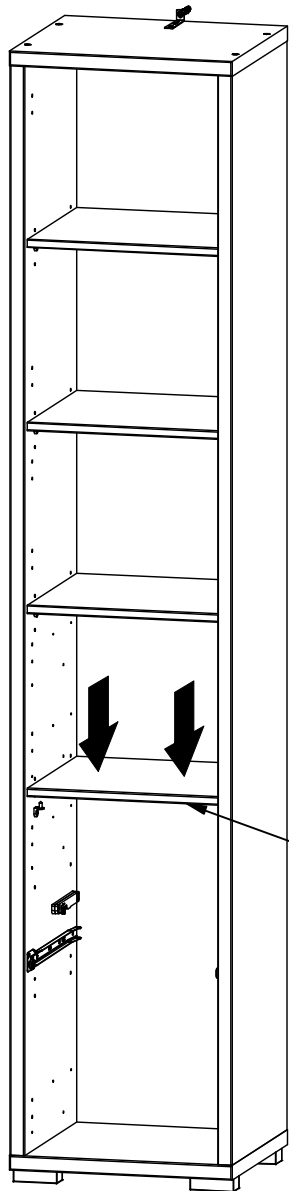

4B



w112\1

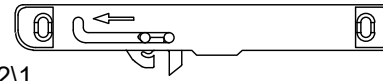

w112\2

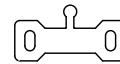

w112\1

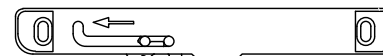

w112\2

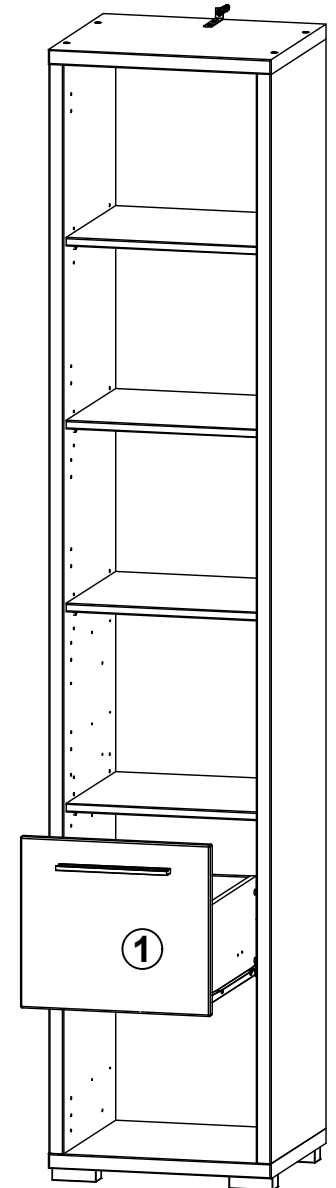

2C

4x
Ø6x13 mm
e3

2x
Ø4x22 mm
p56

1x
w112\1

1x
350 mm
w45\CL

1x
350 mm
w45\CR

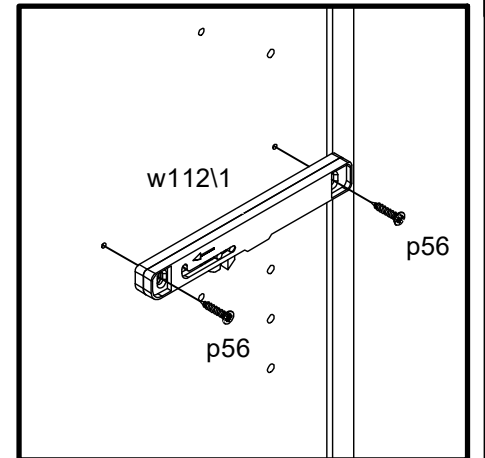
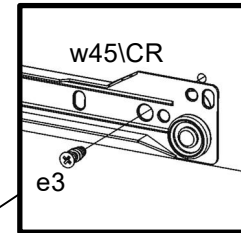
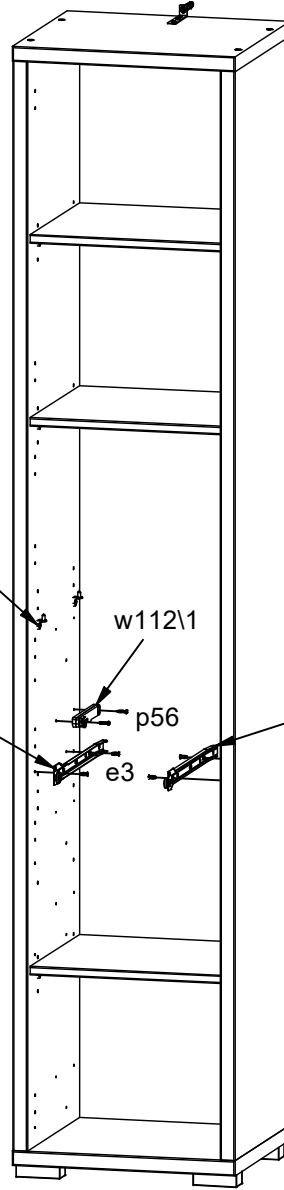
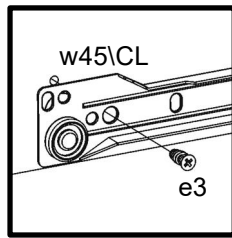
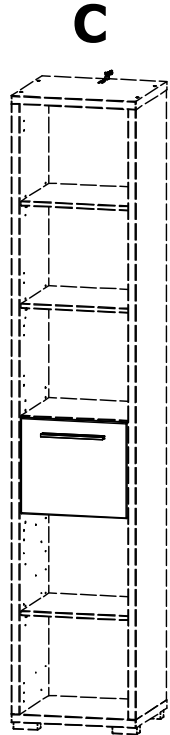
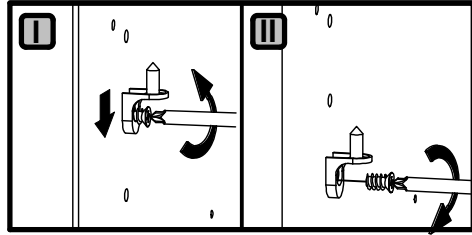

S643-REG/213/43

2C

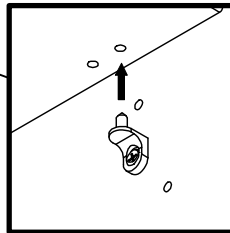
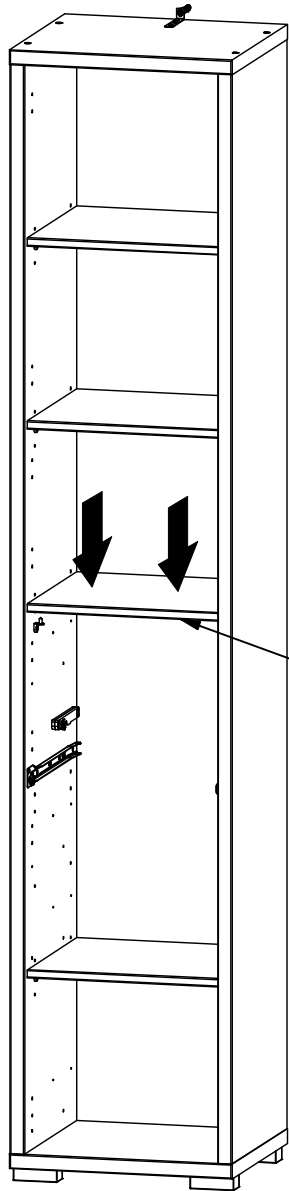

3C



w112\1

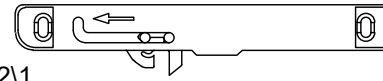

w112\2

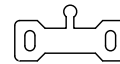

w112\1

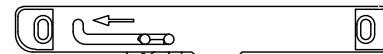

w112\2

