

UNIT 3600/2024

01	915x506x16	1/1

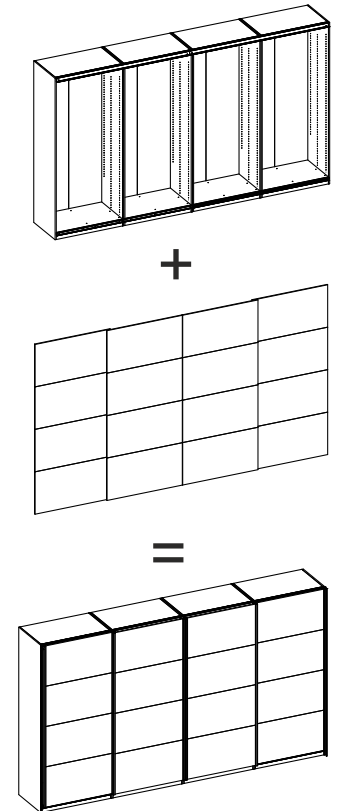

C 1/1

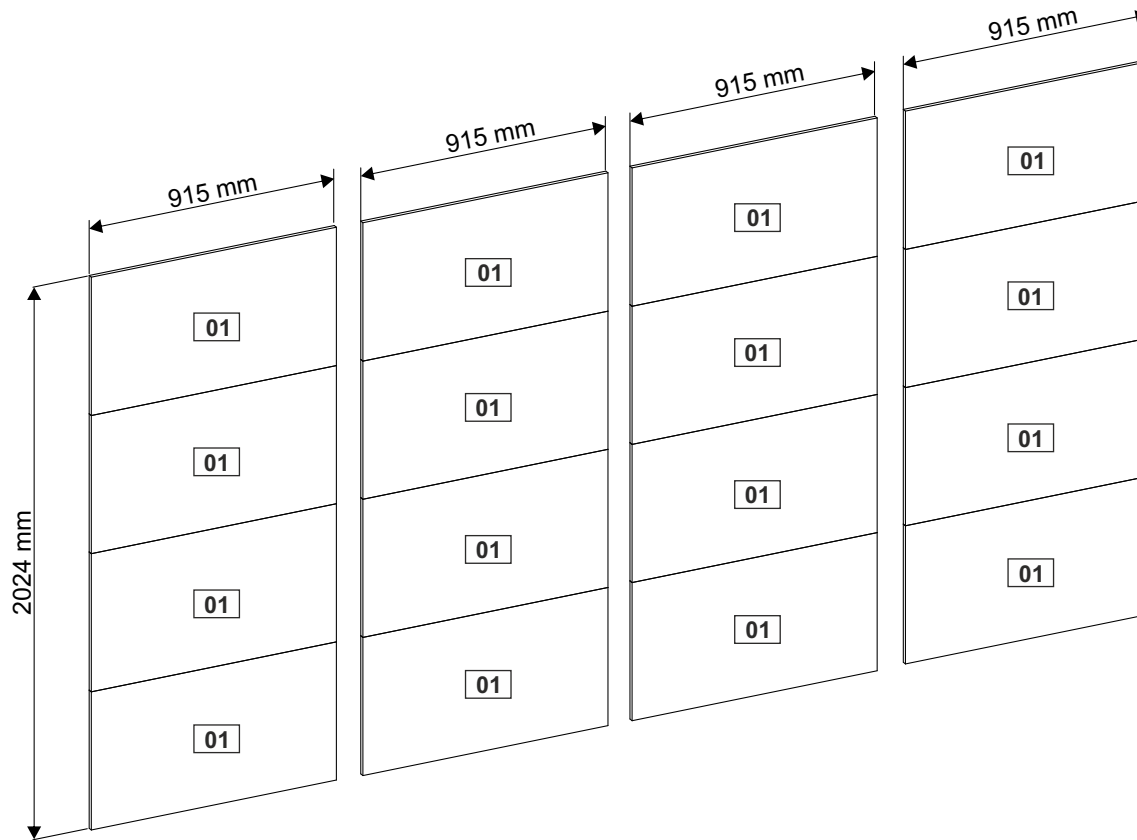
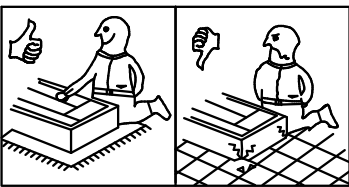
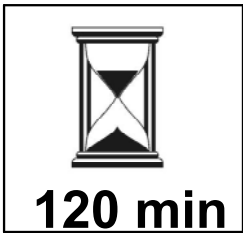
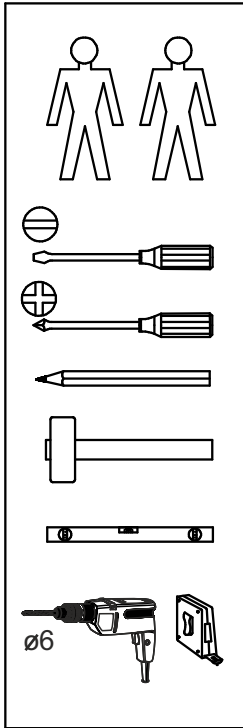
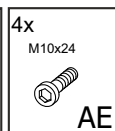
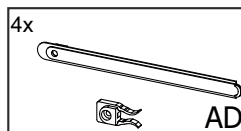
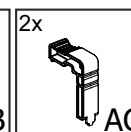
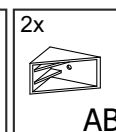
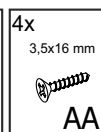
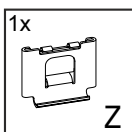
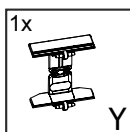
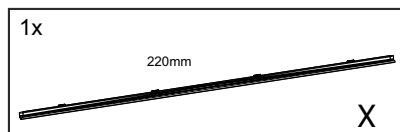
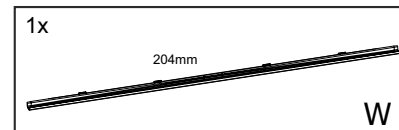
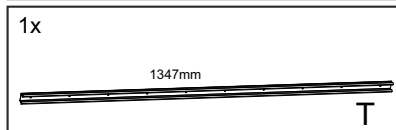
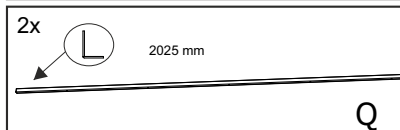
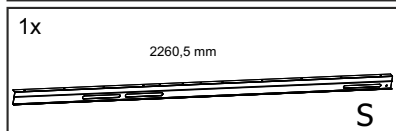
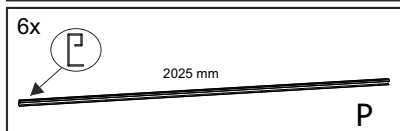
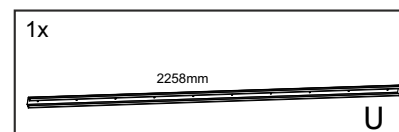
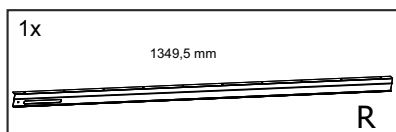
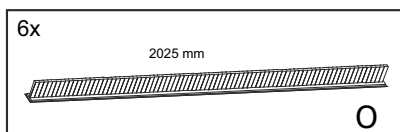
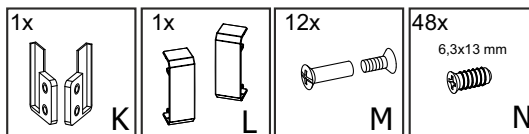
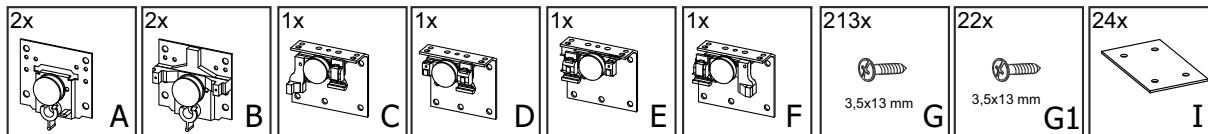

1

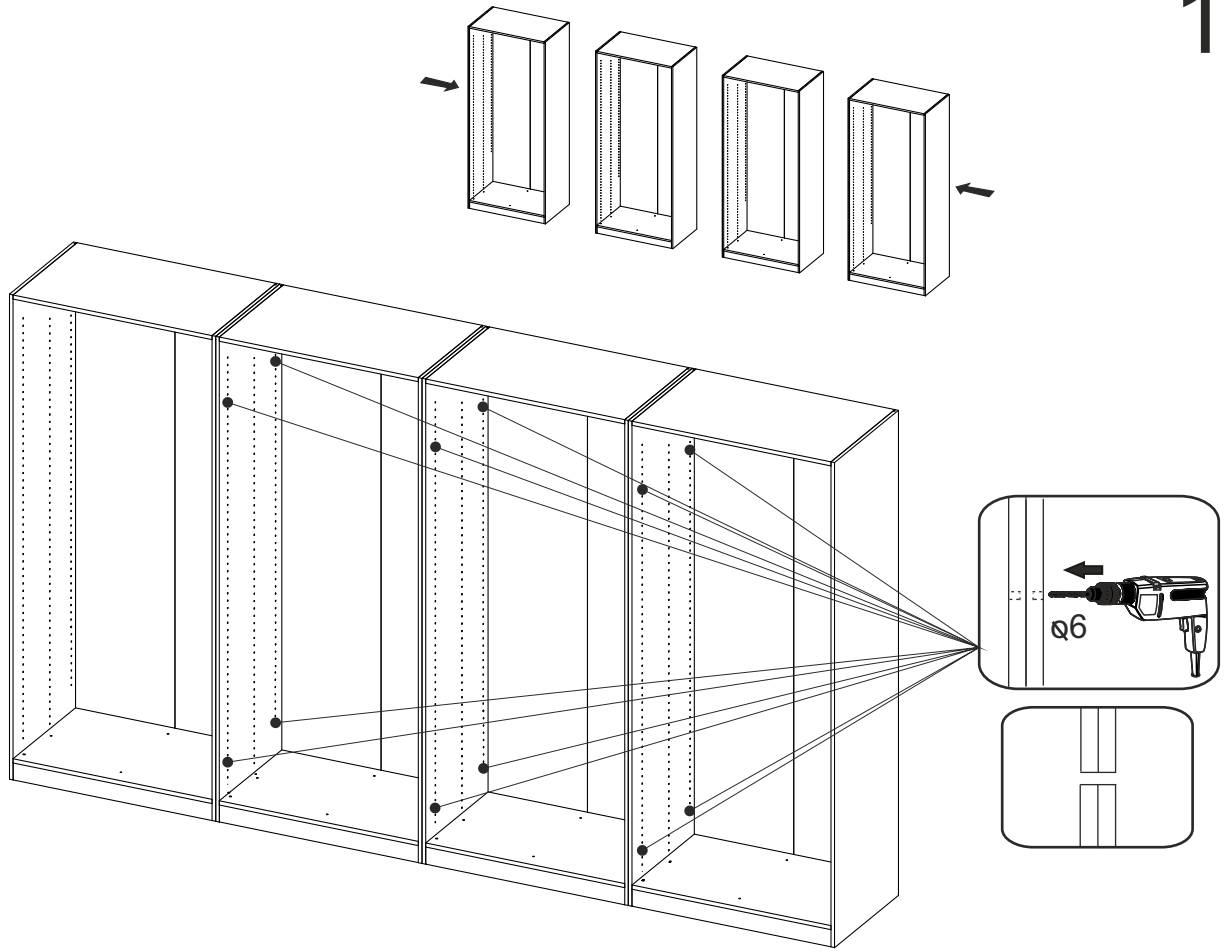

2

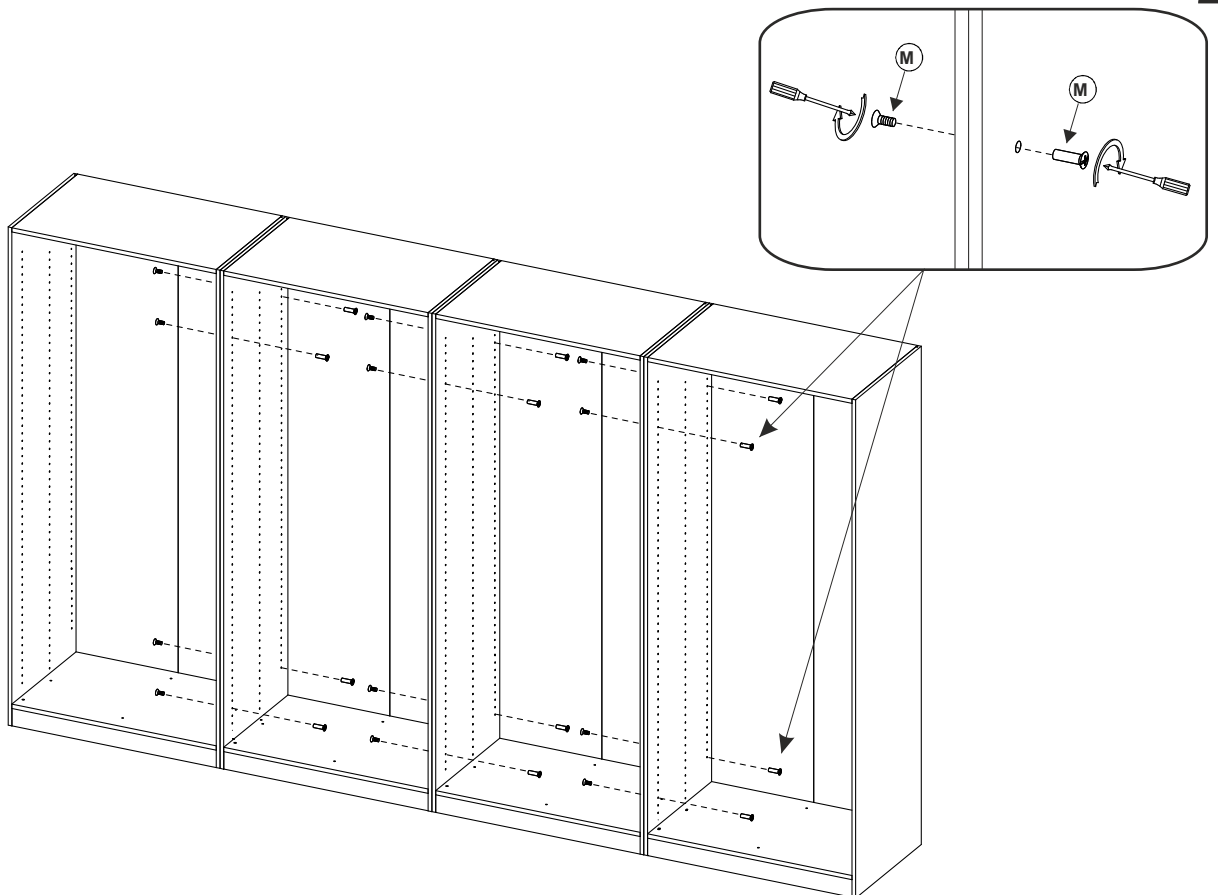
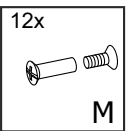

3

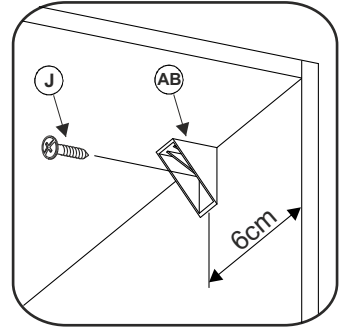
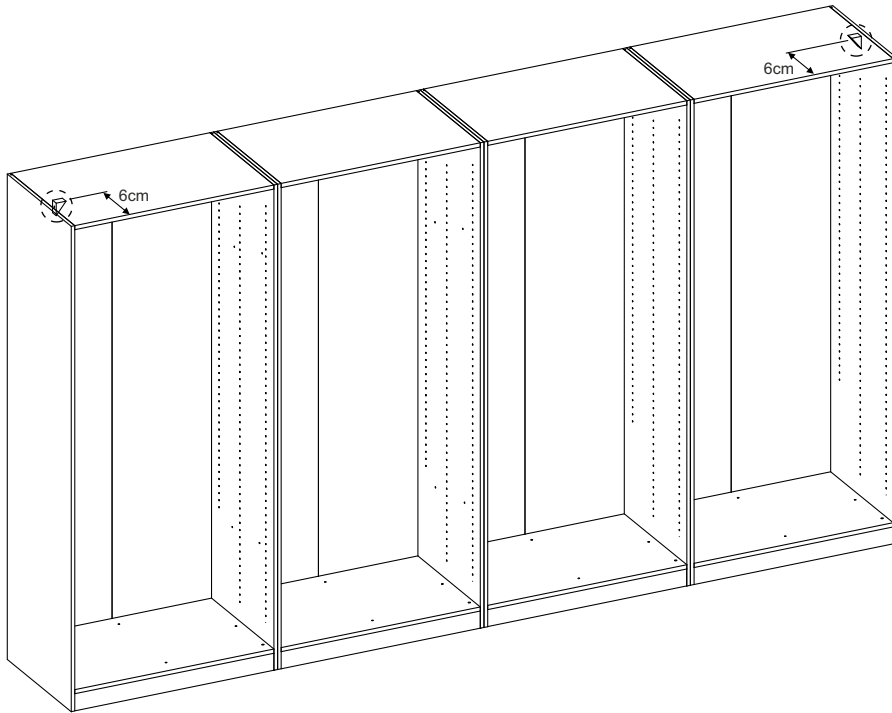
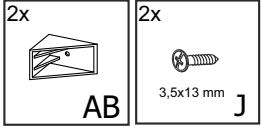

4

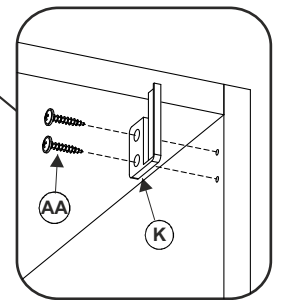
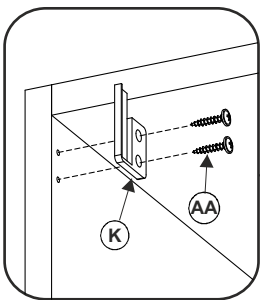
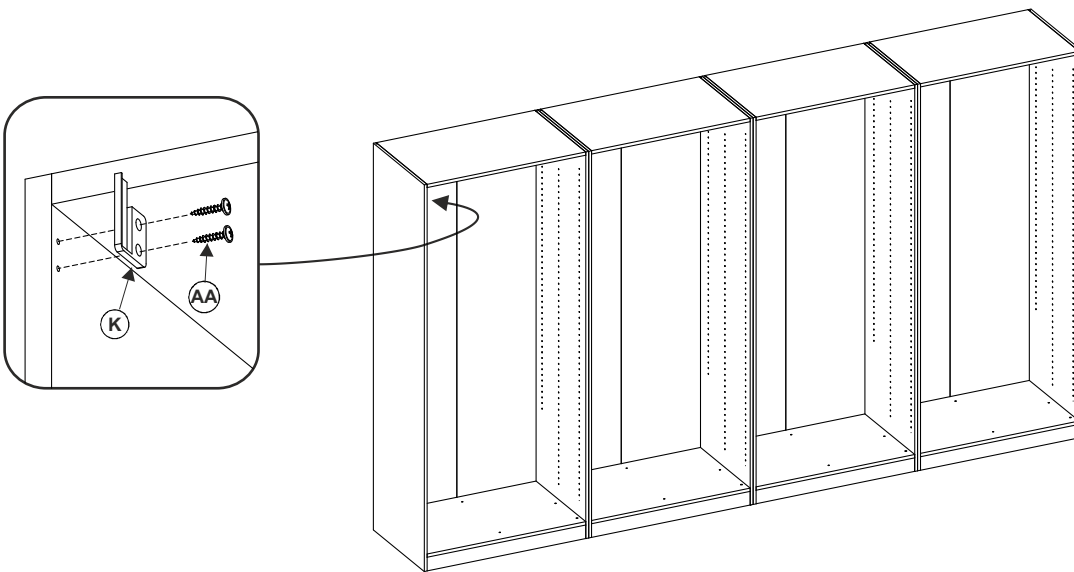
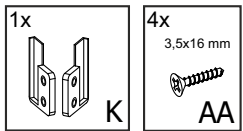

7x
3,5x13 mm J

1x 1349,5 mm R

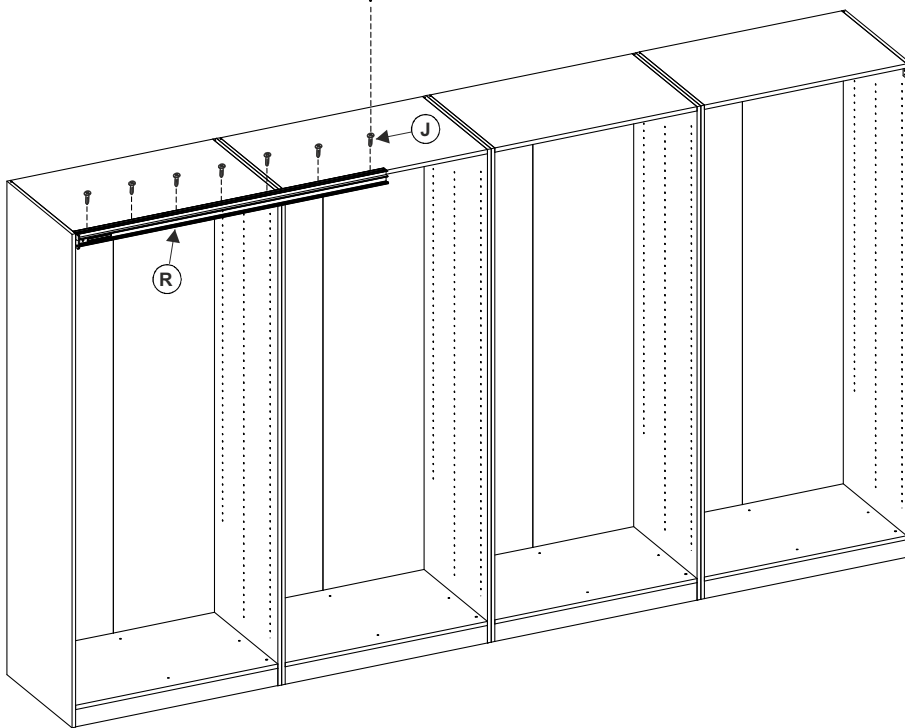
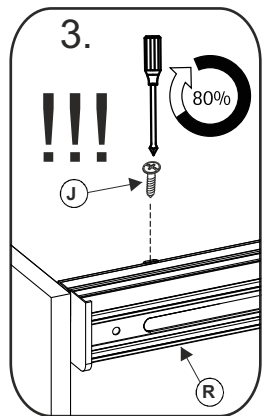
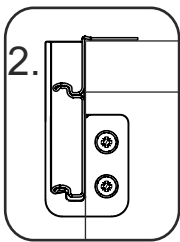
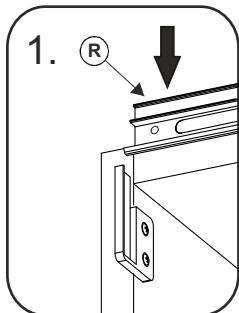
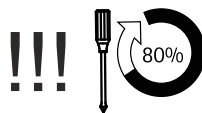

11x
3,5x13 mm J

1x 2260,5 mm S

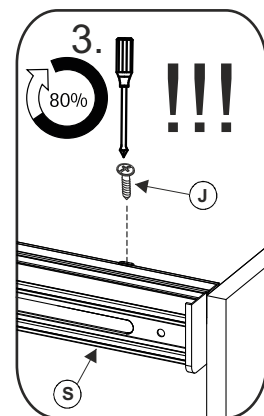
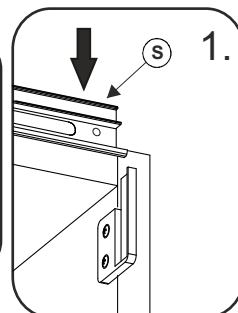
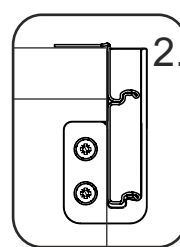
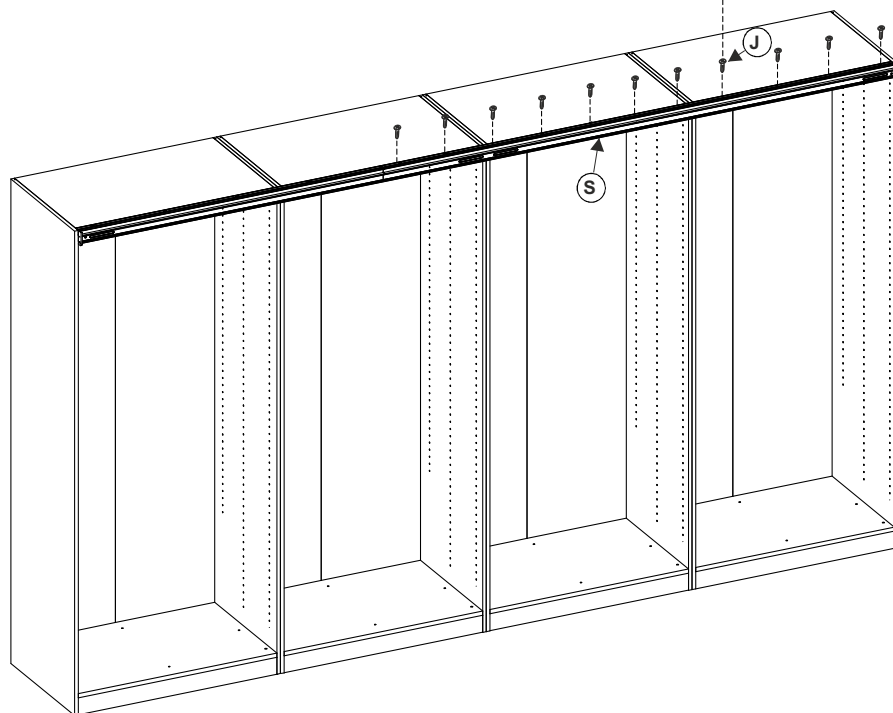
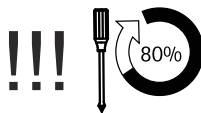

7

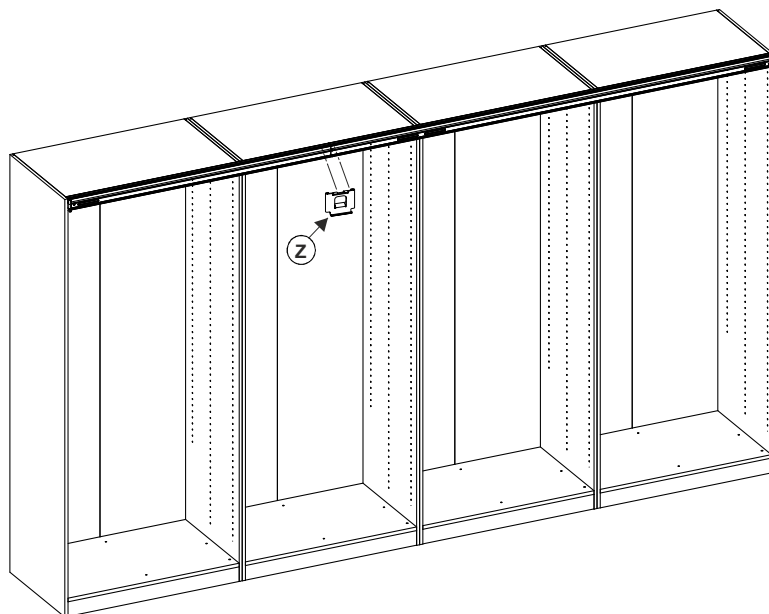
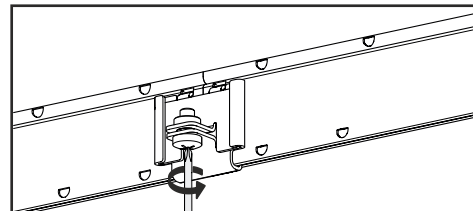
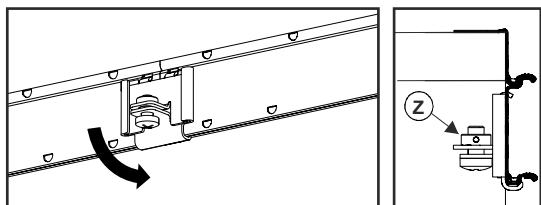
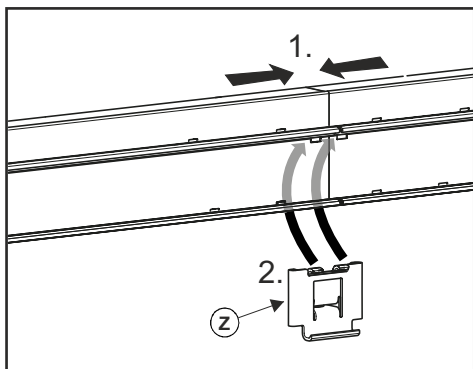
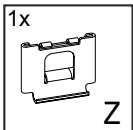

8

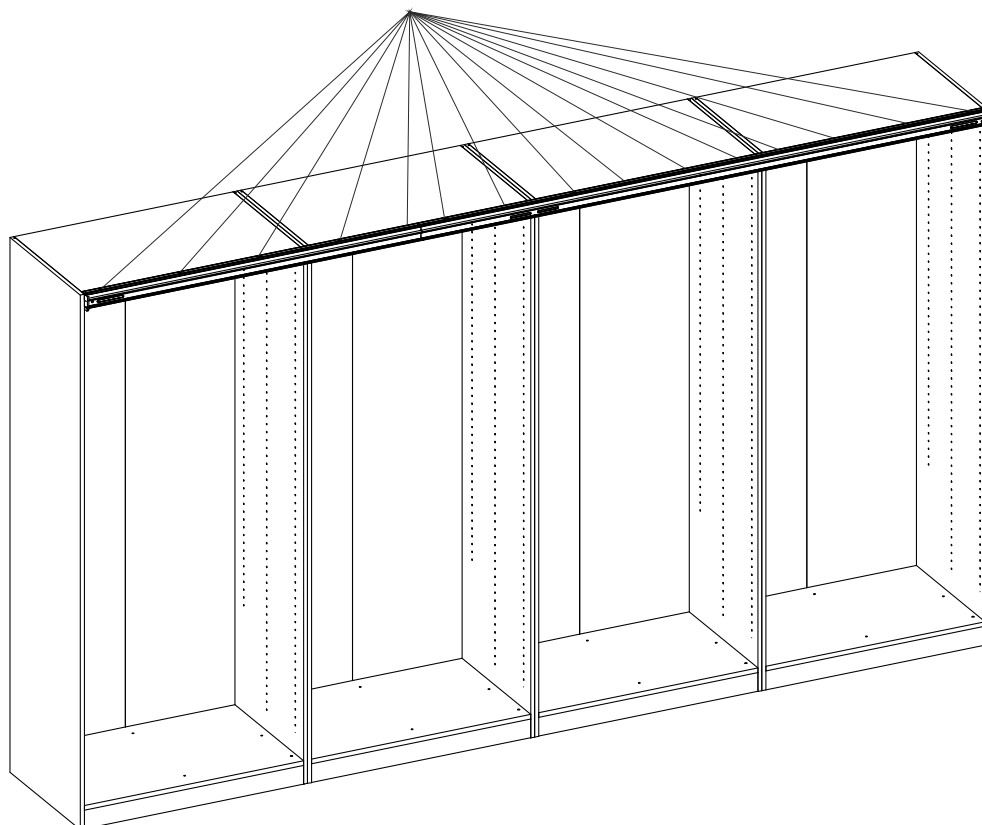
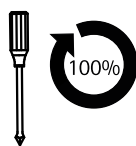

UNIT 3600/2024

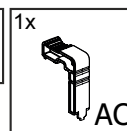
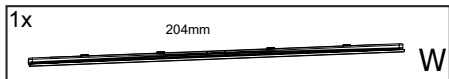

9

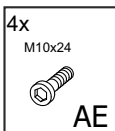
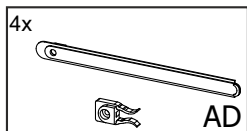
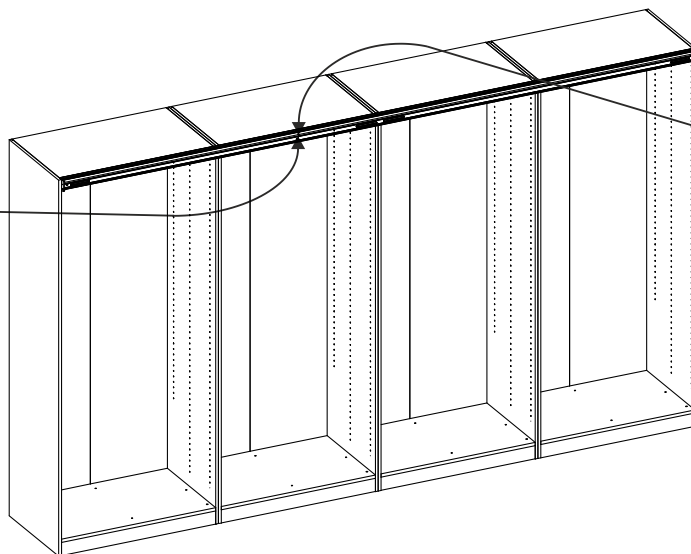
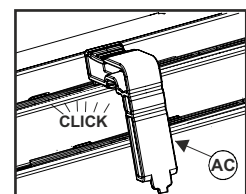
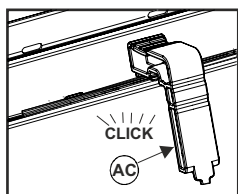
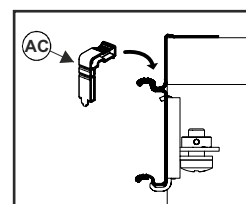
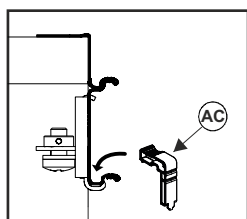
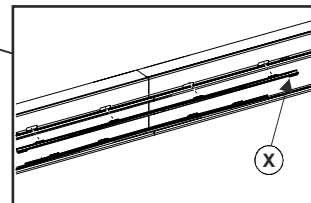
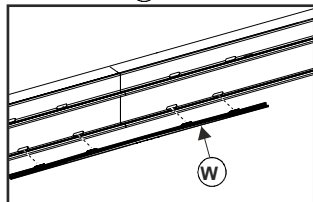
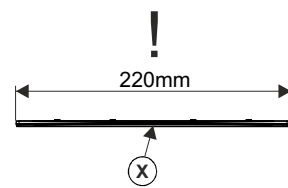
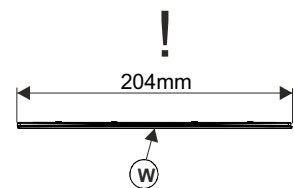

10

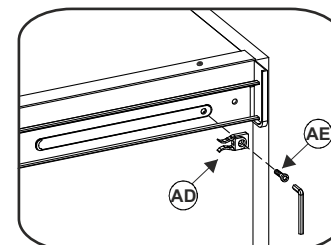
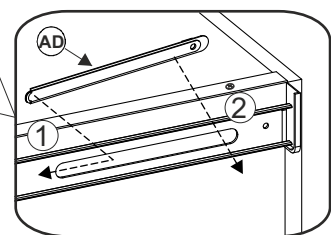
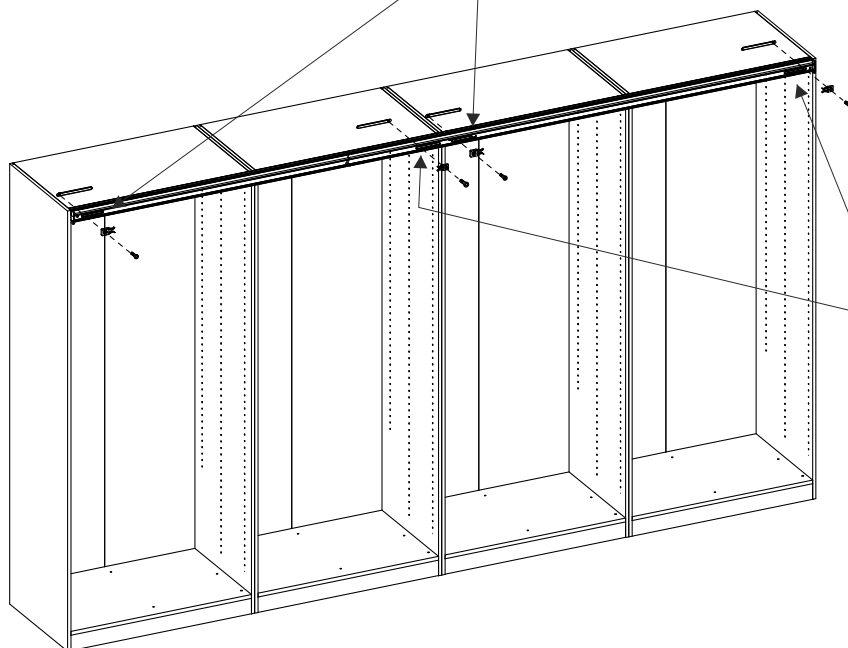
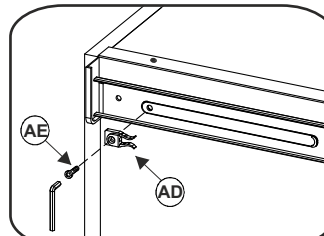
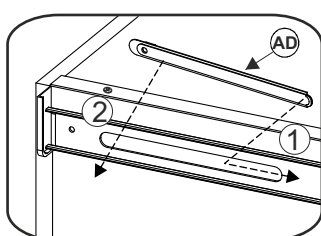

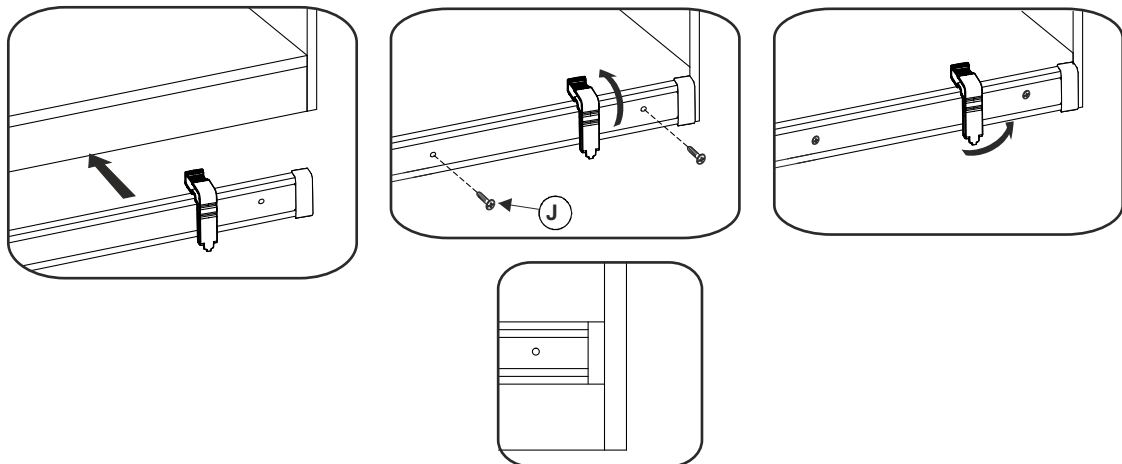
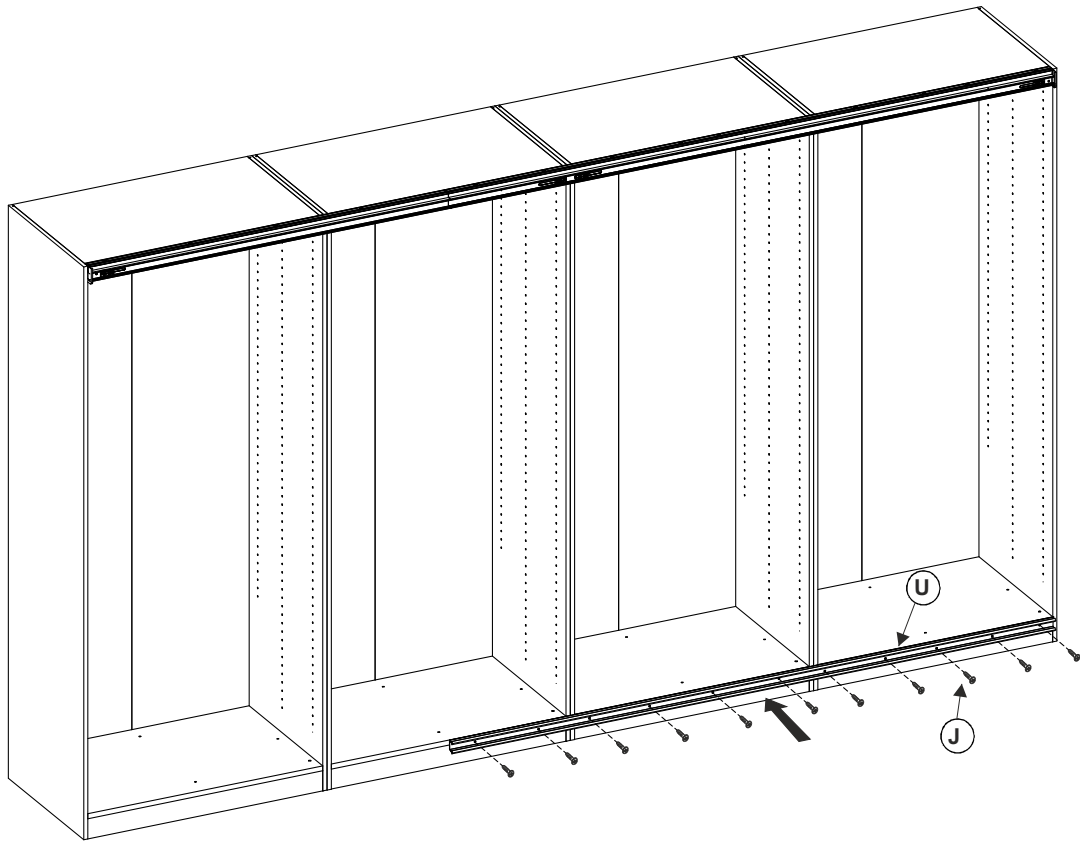
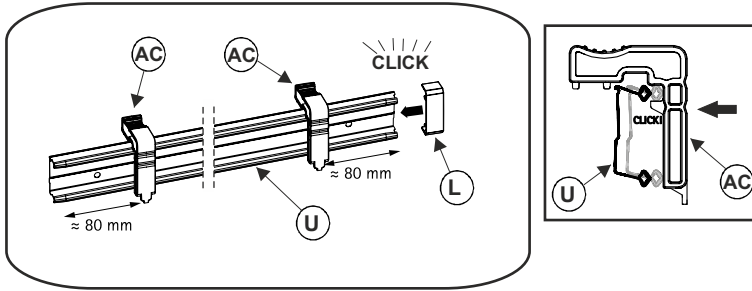
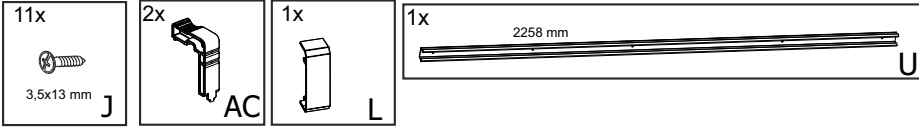

12

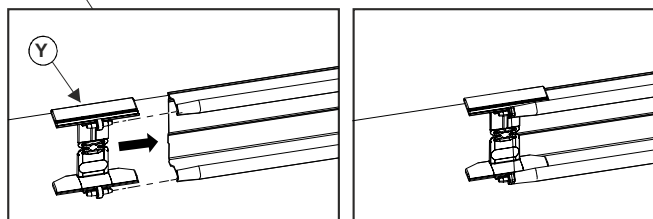
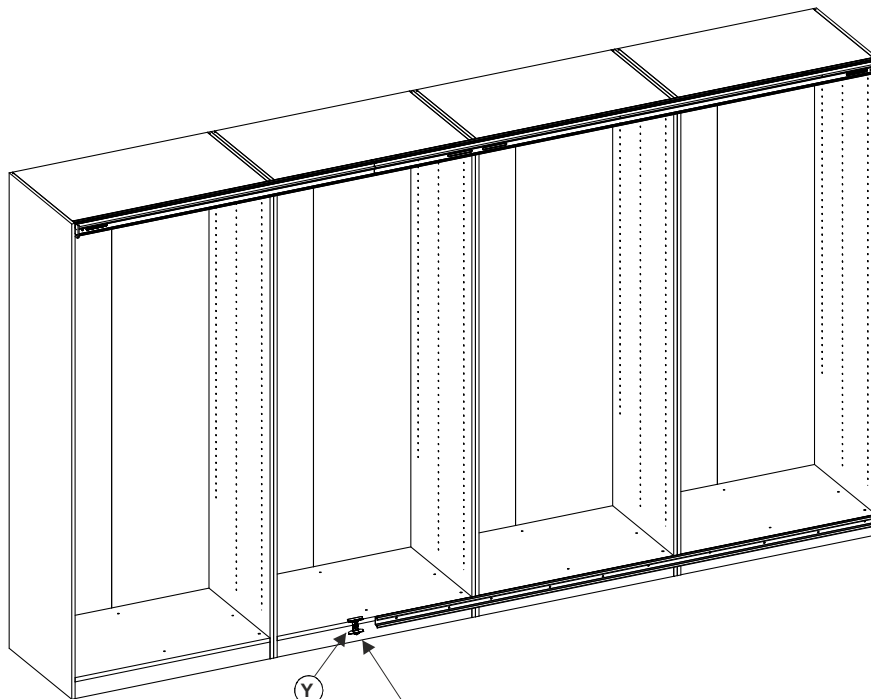
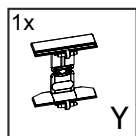

13

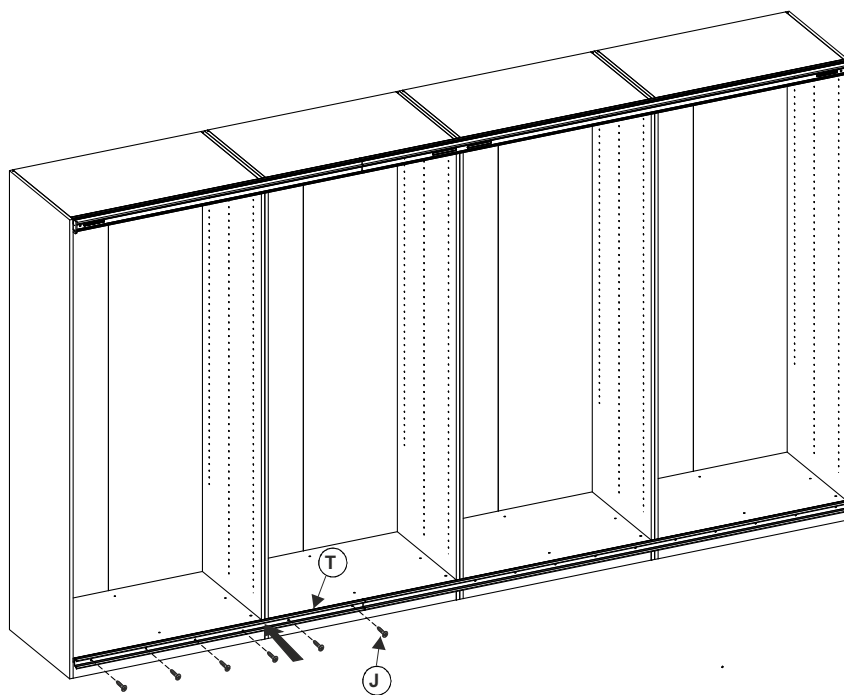
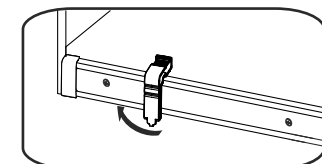
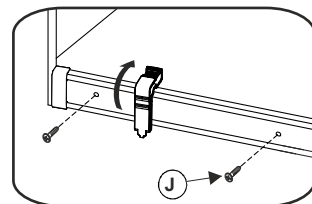
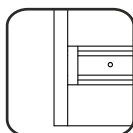
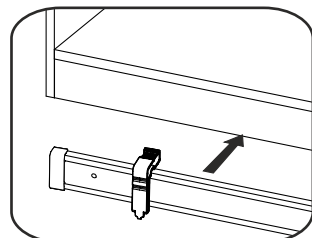
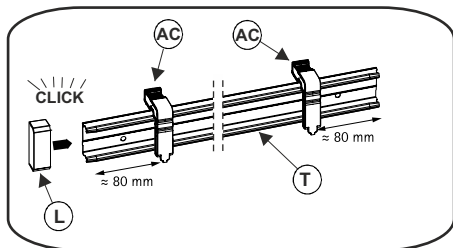
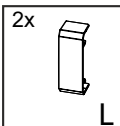
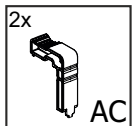
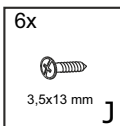

14

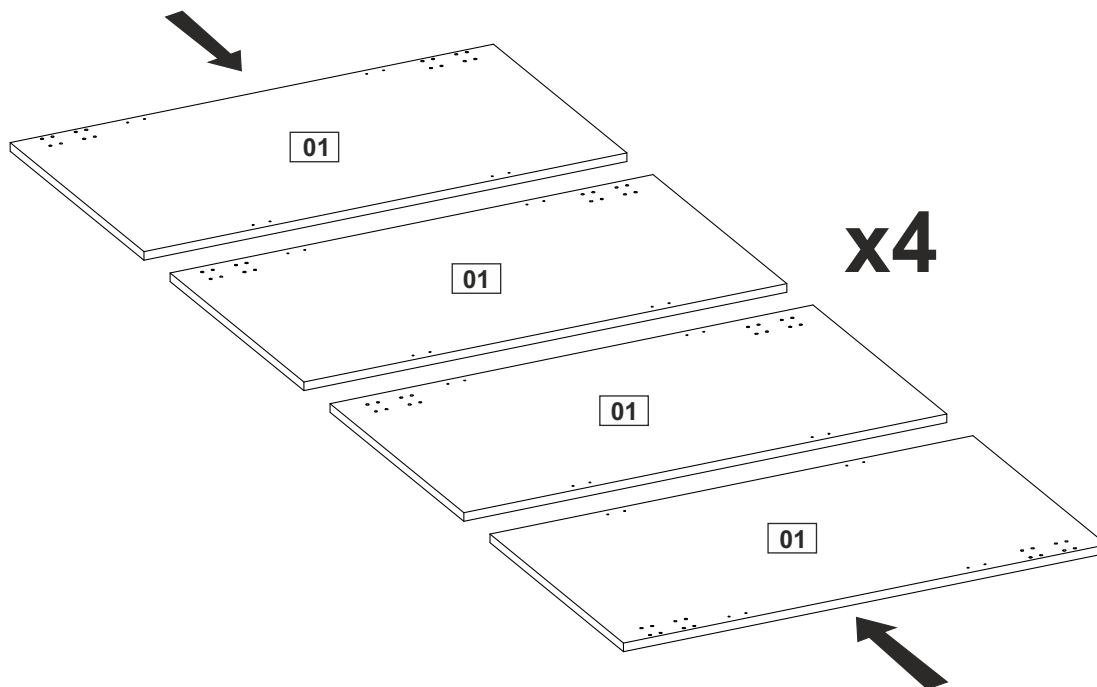
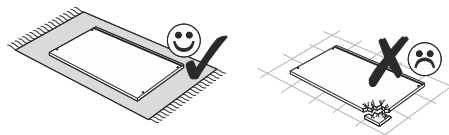

96x



3.5x13 mm

J

24x

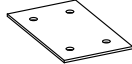

I

15

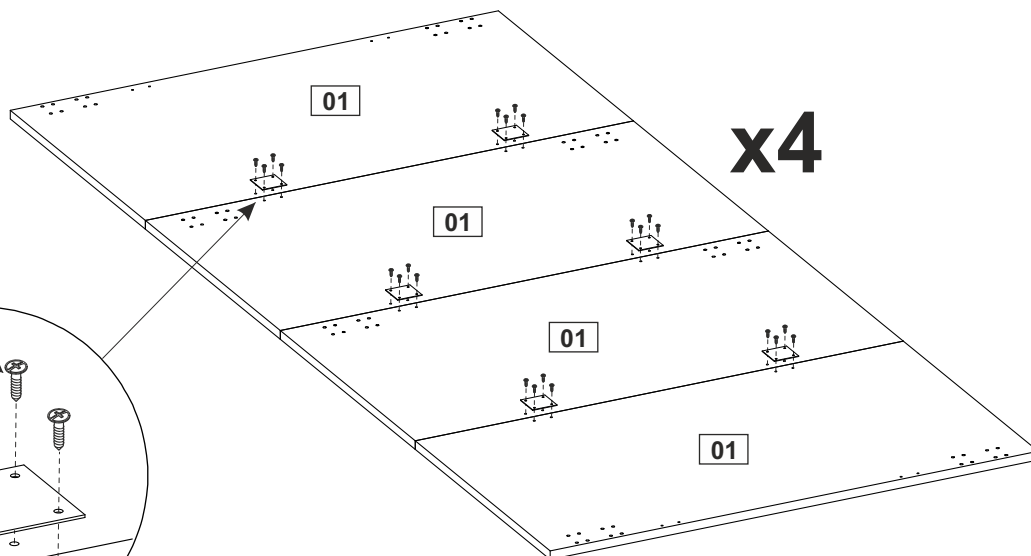
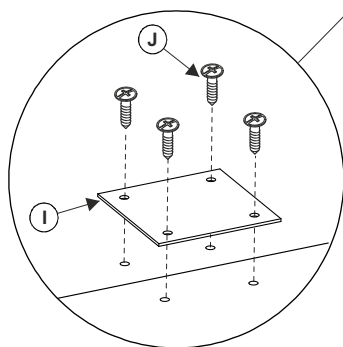
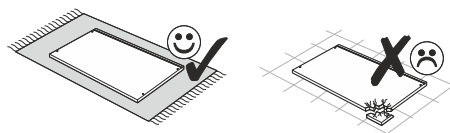

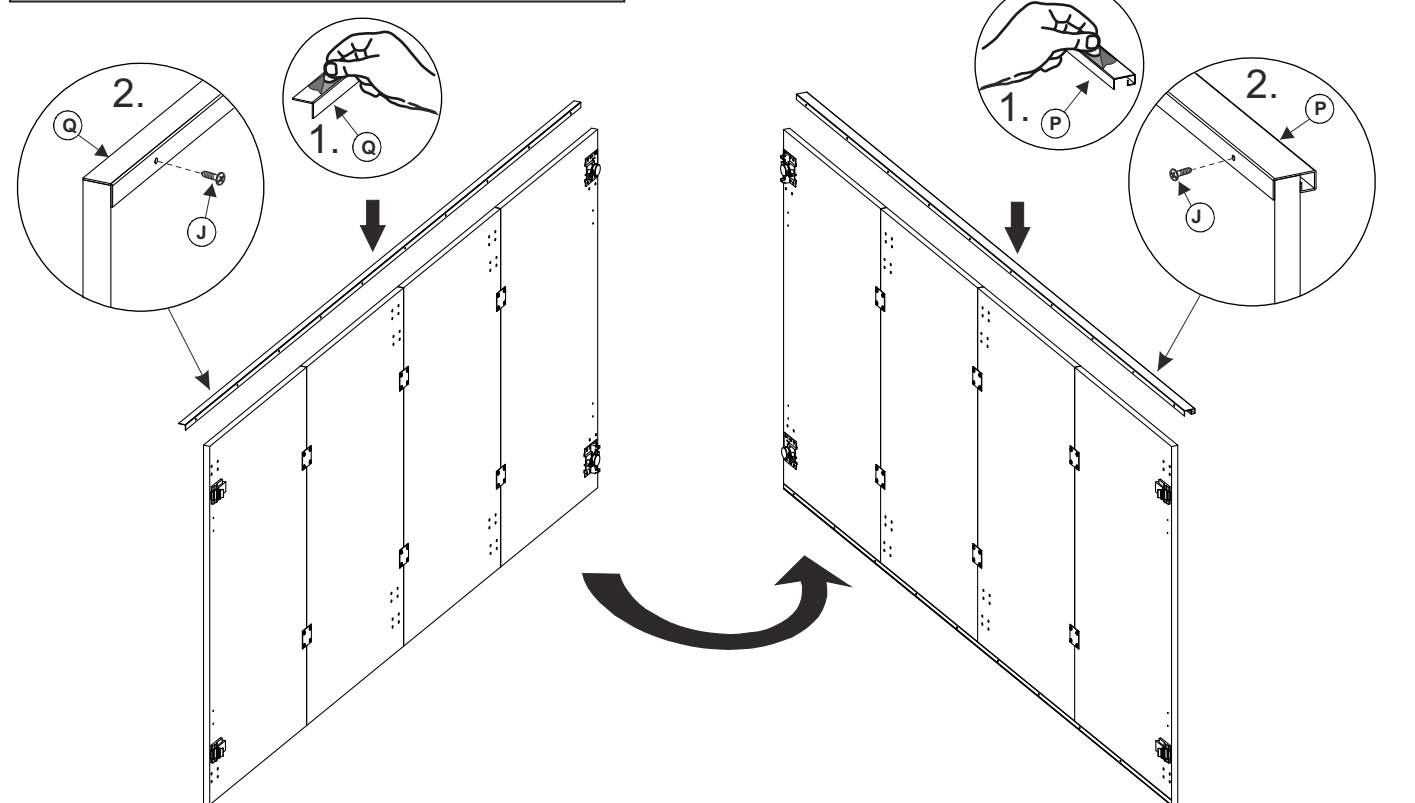
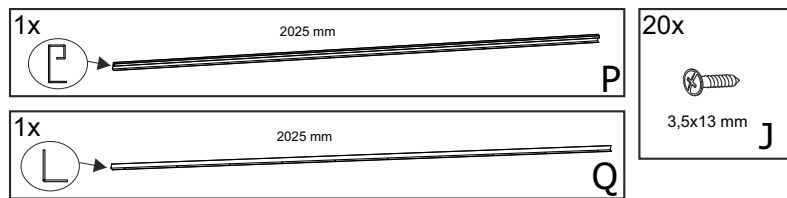
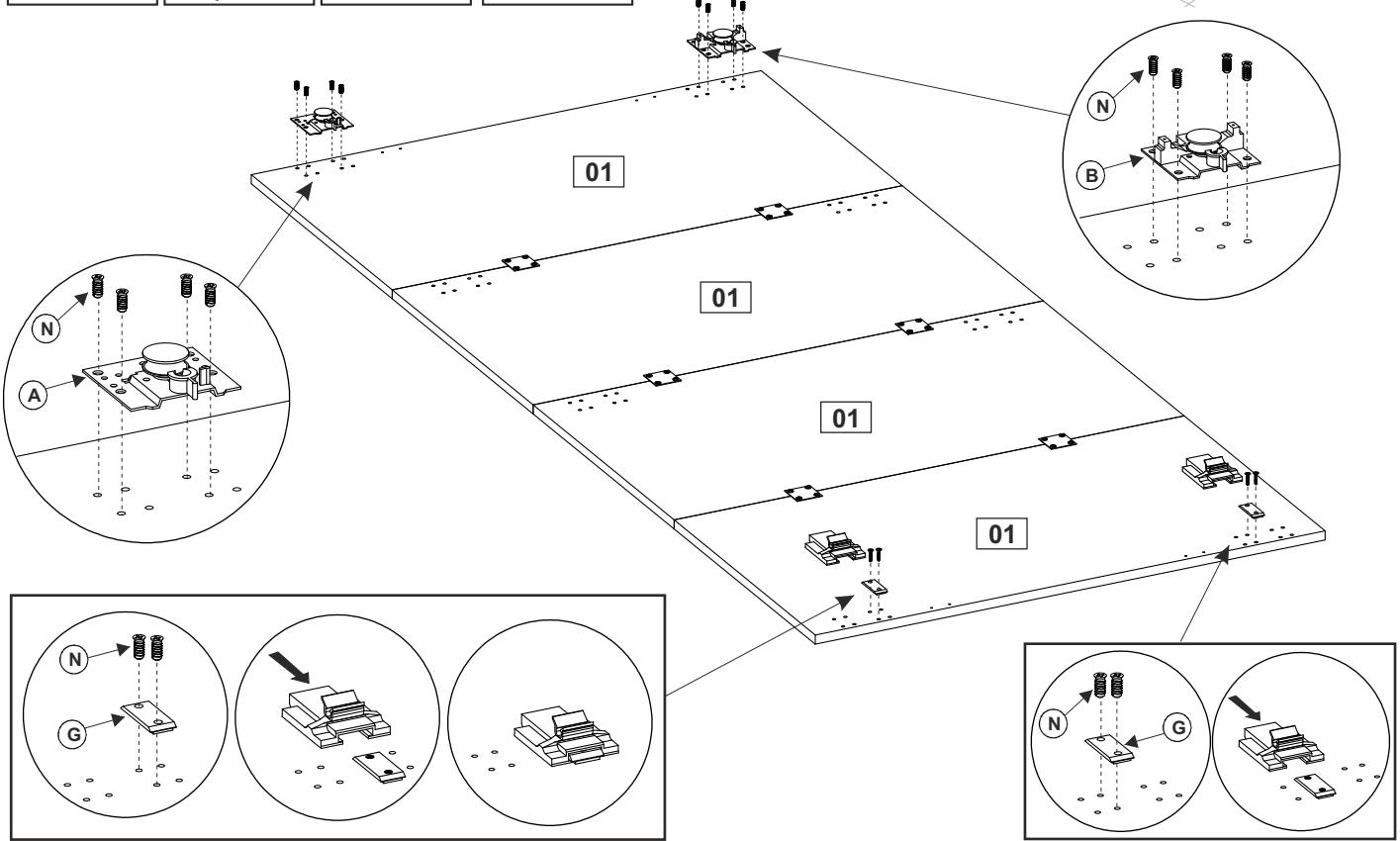
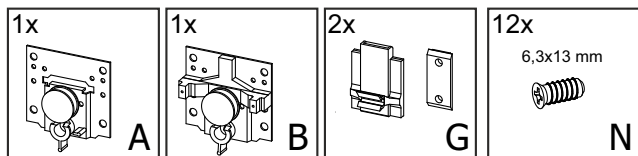

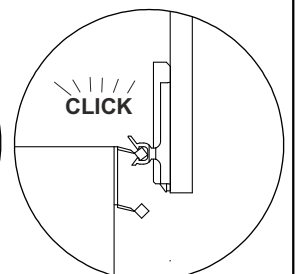
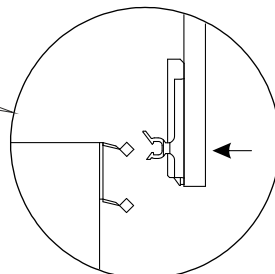
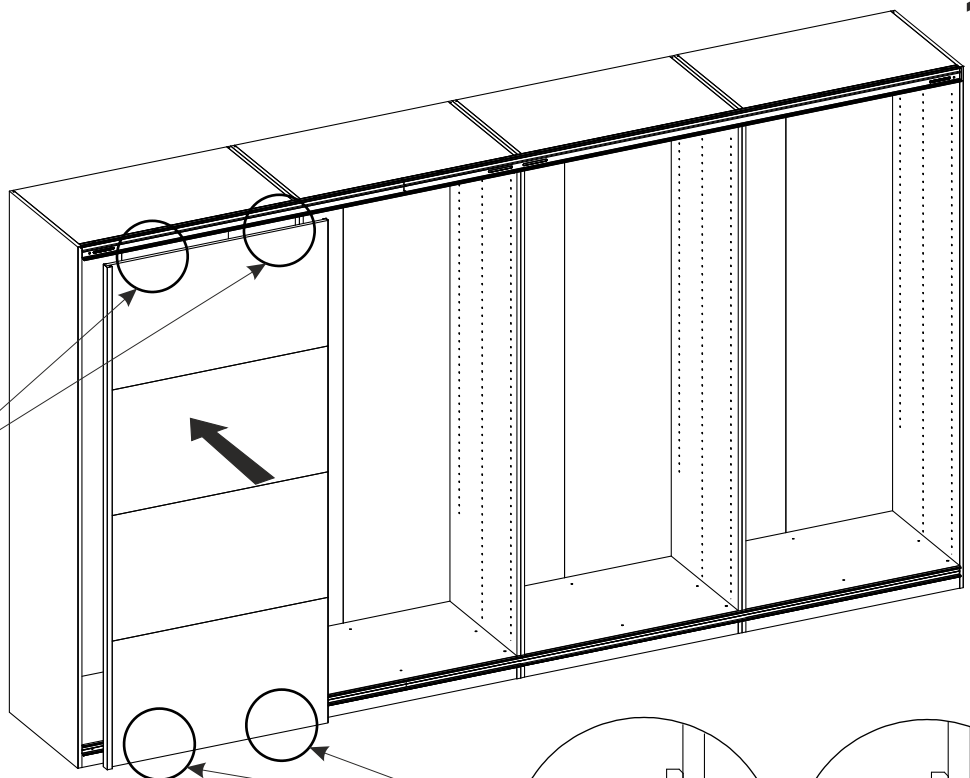
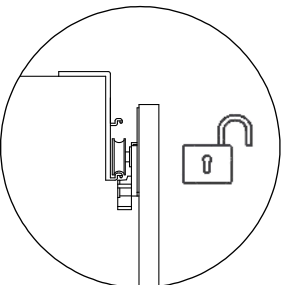
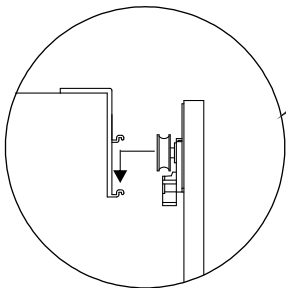
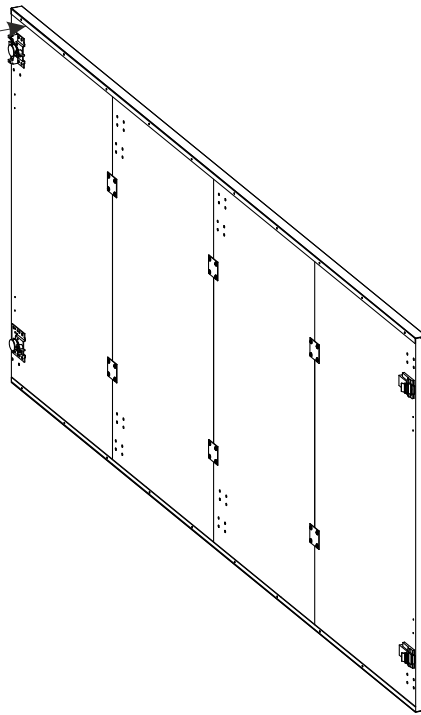
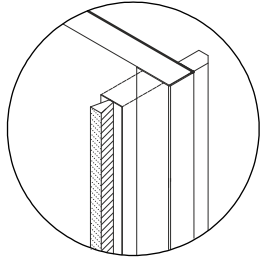
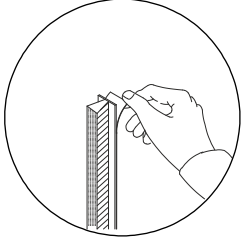
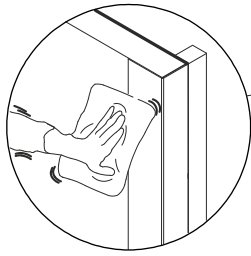
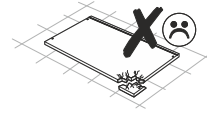
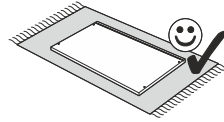
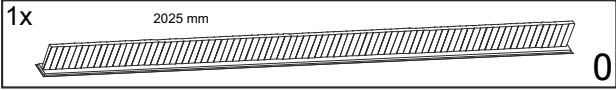

20

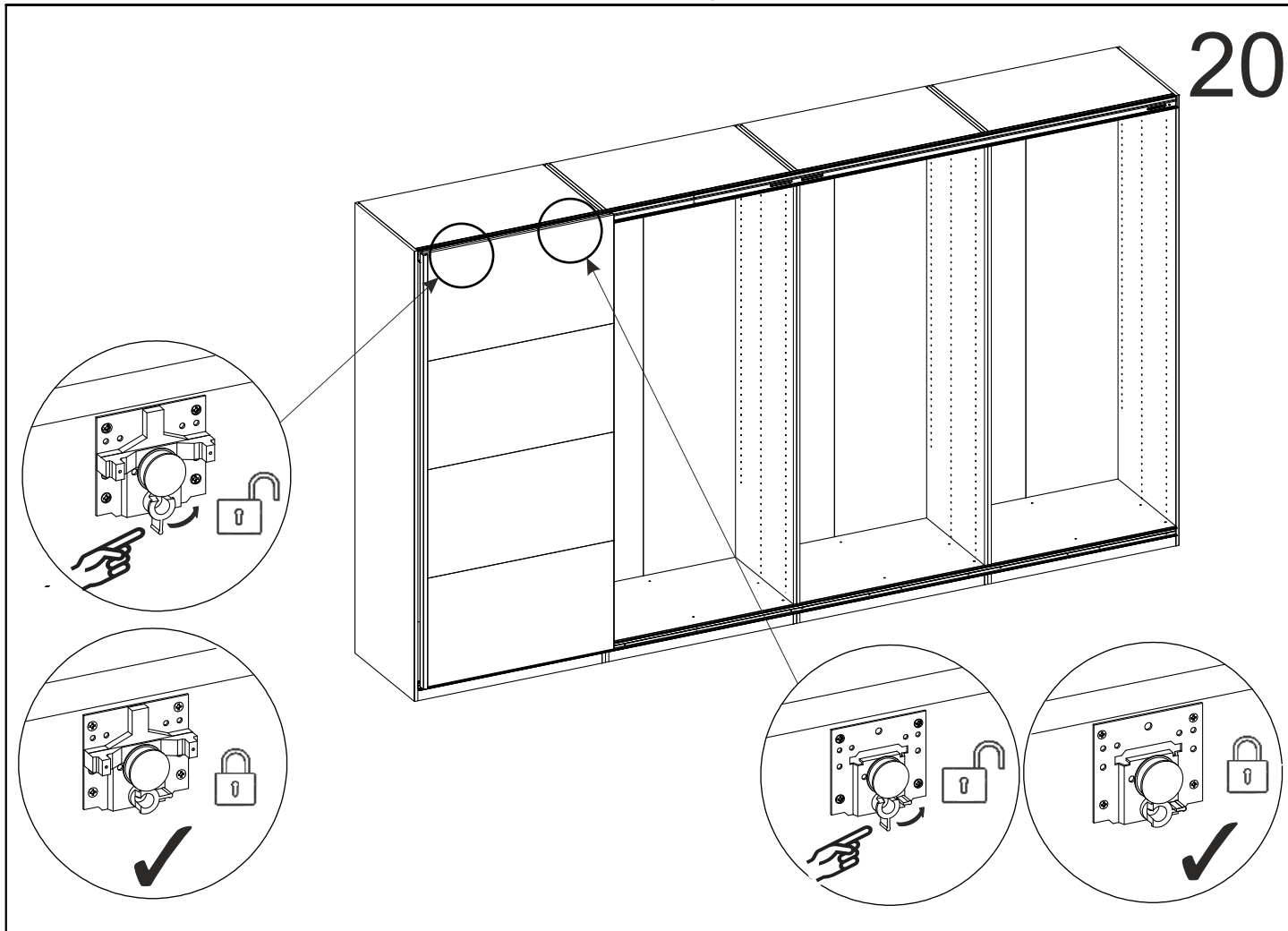

21

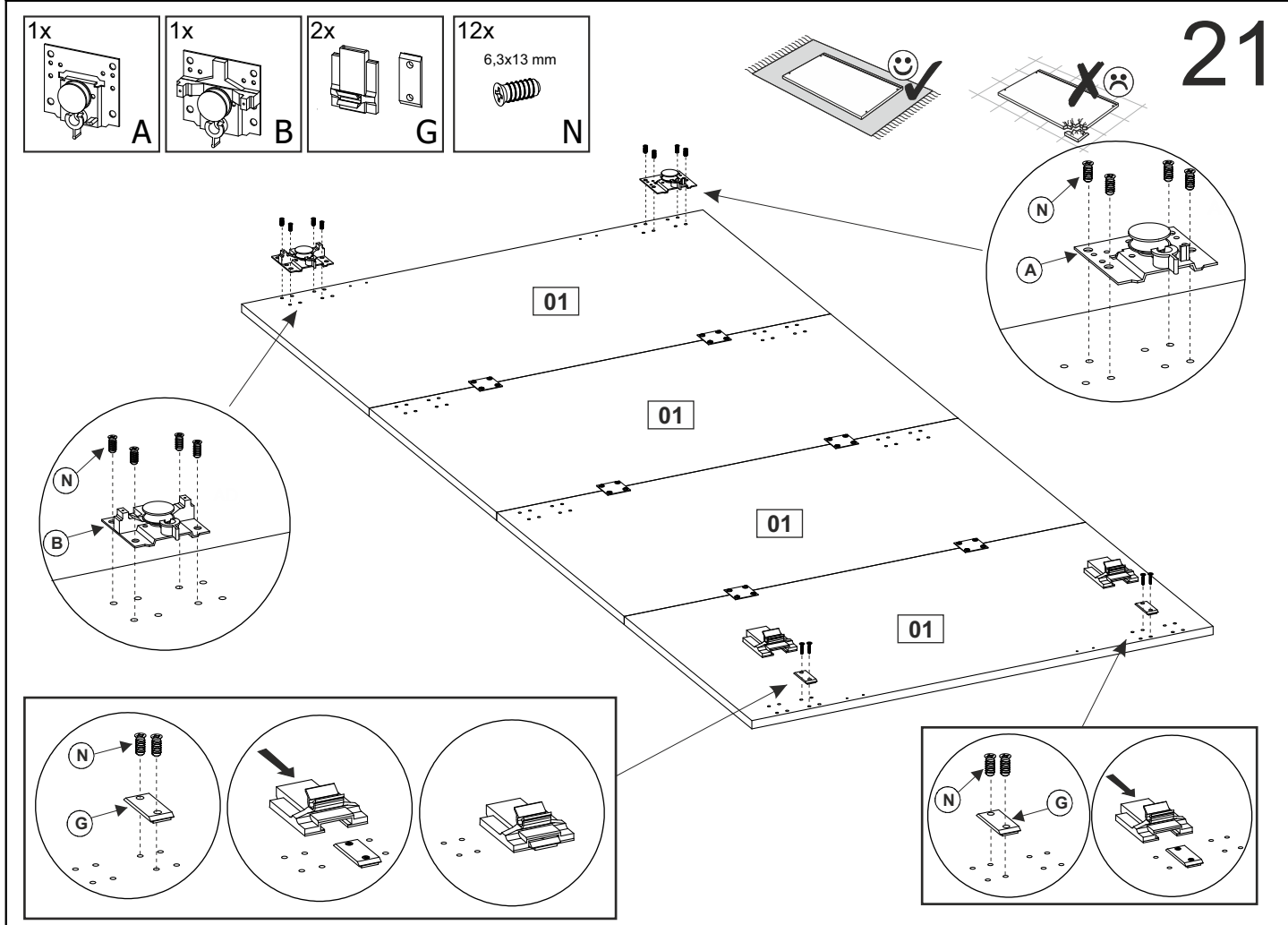

UNIT 3600/2024

22

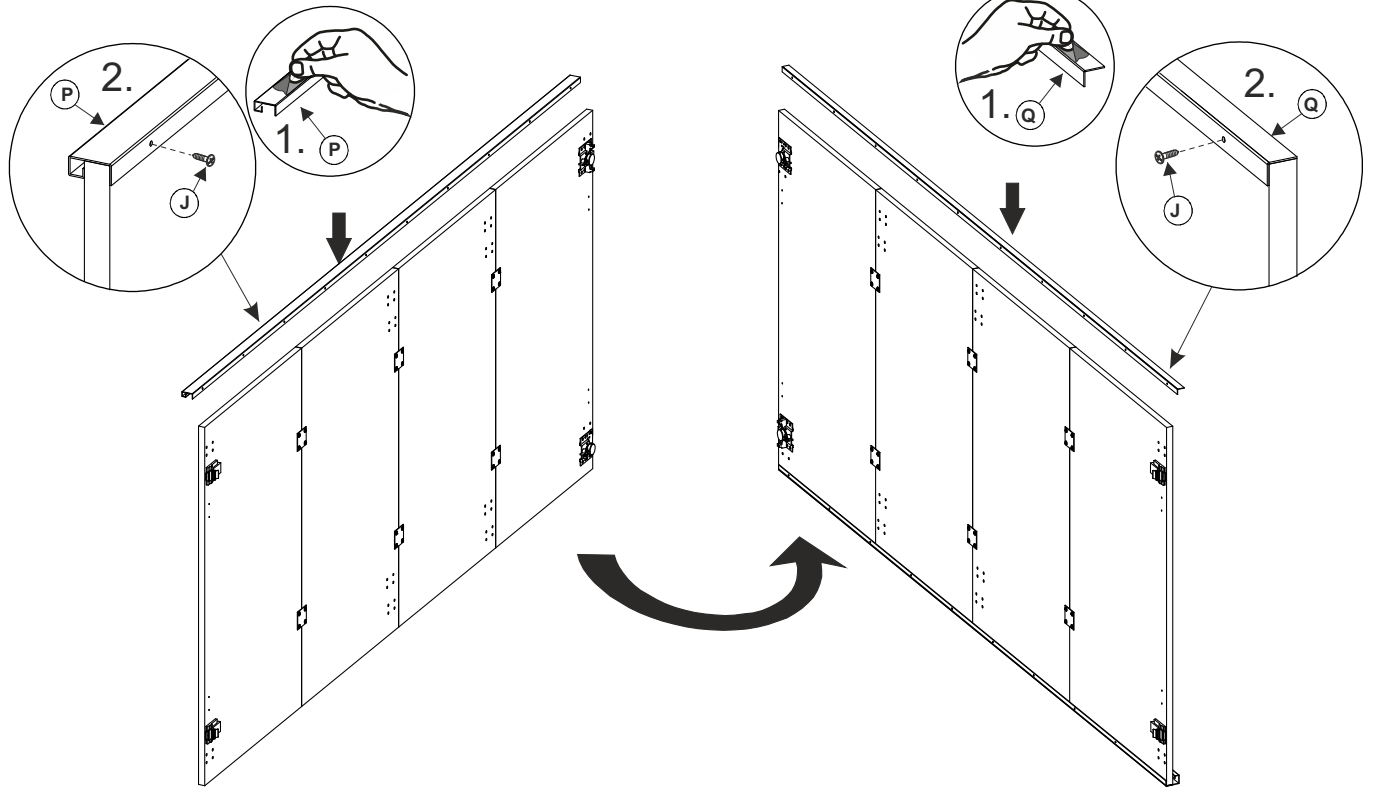
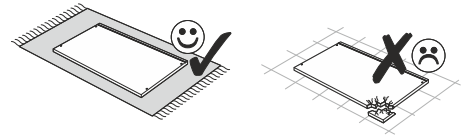
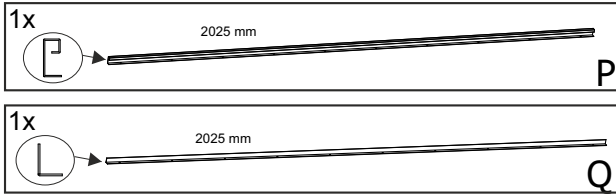

23

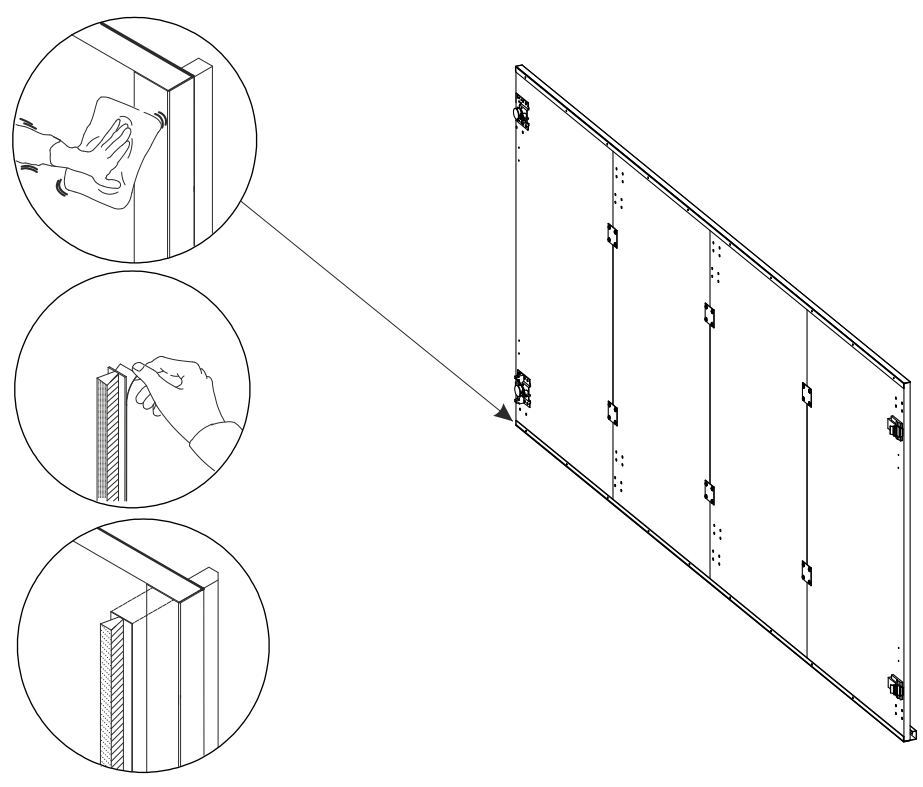
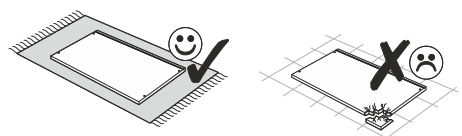
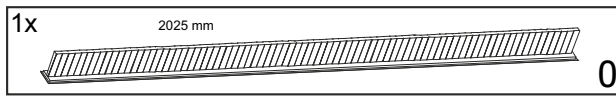

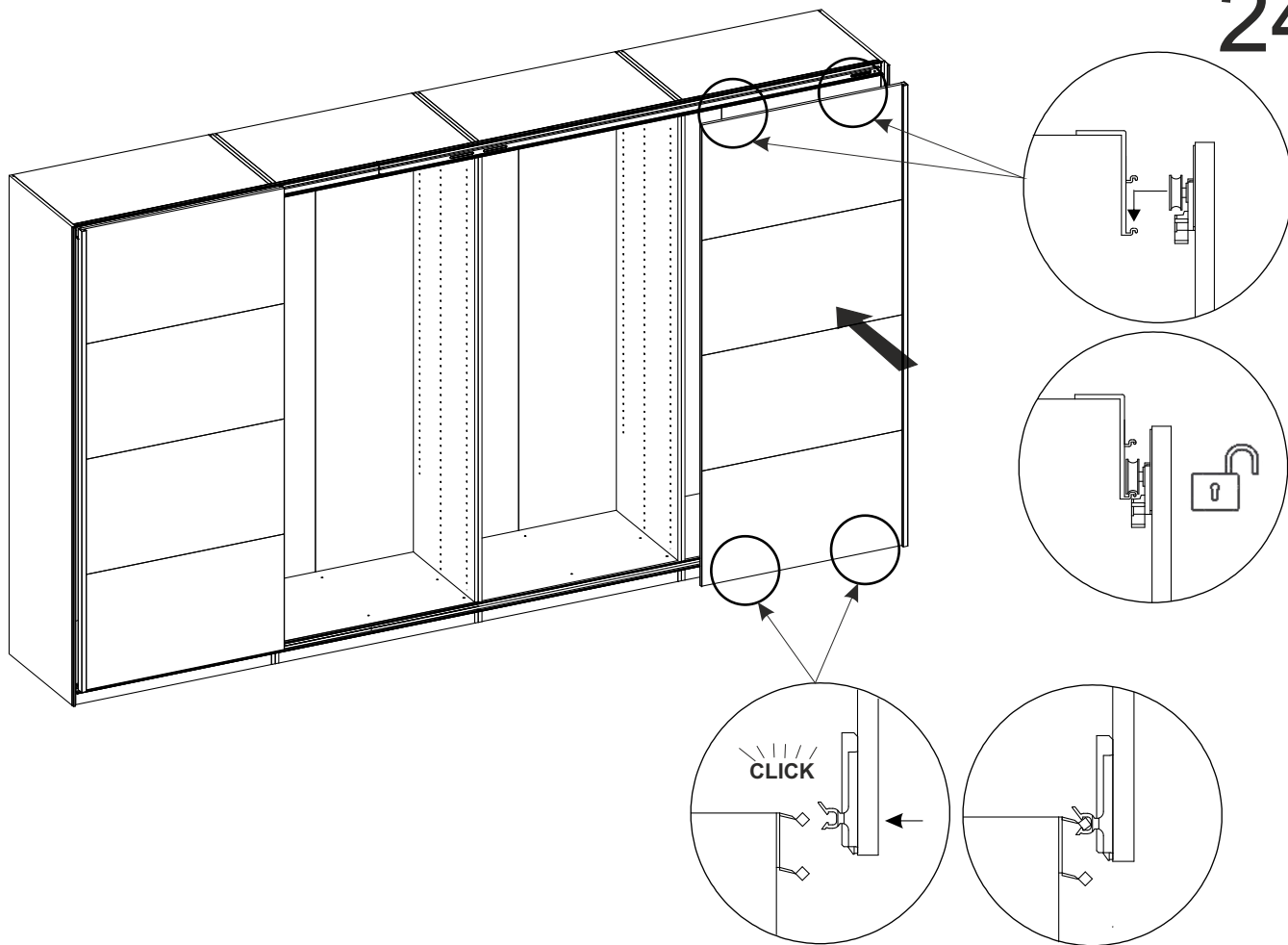

24



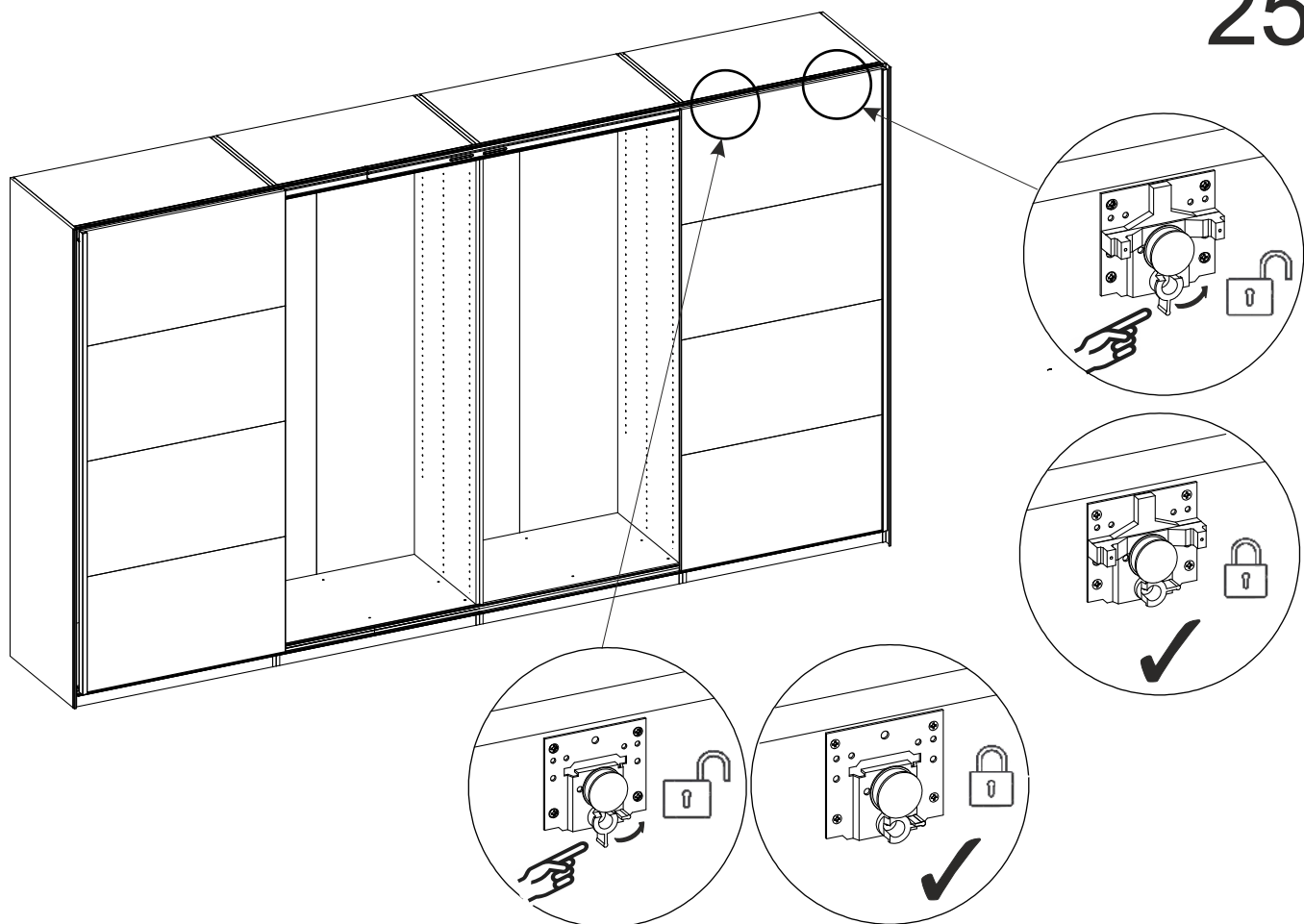

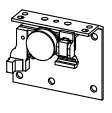
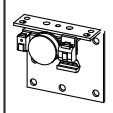
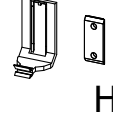
25

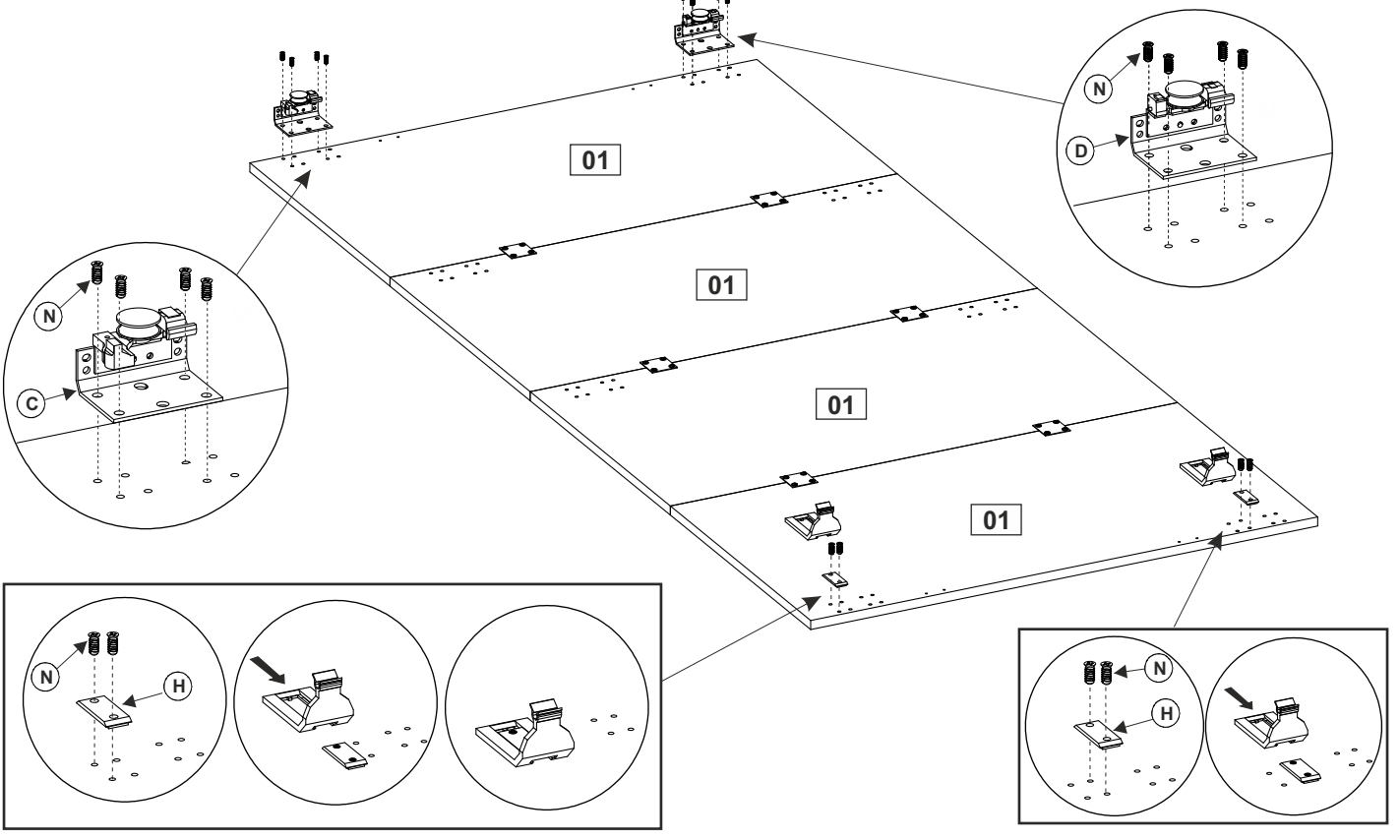
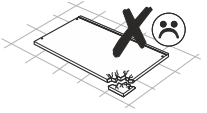
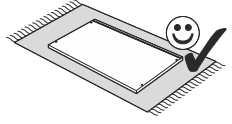

- 1x  C
- 1x  D
- 2x  H
- 12x  N
6,3x13 mm

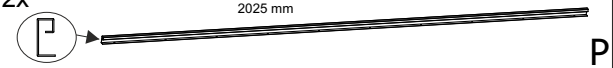

- 2x  P
2025 mm
- 20x  J
3,5x13 mm

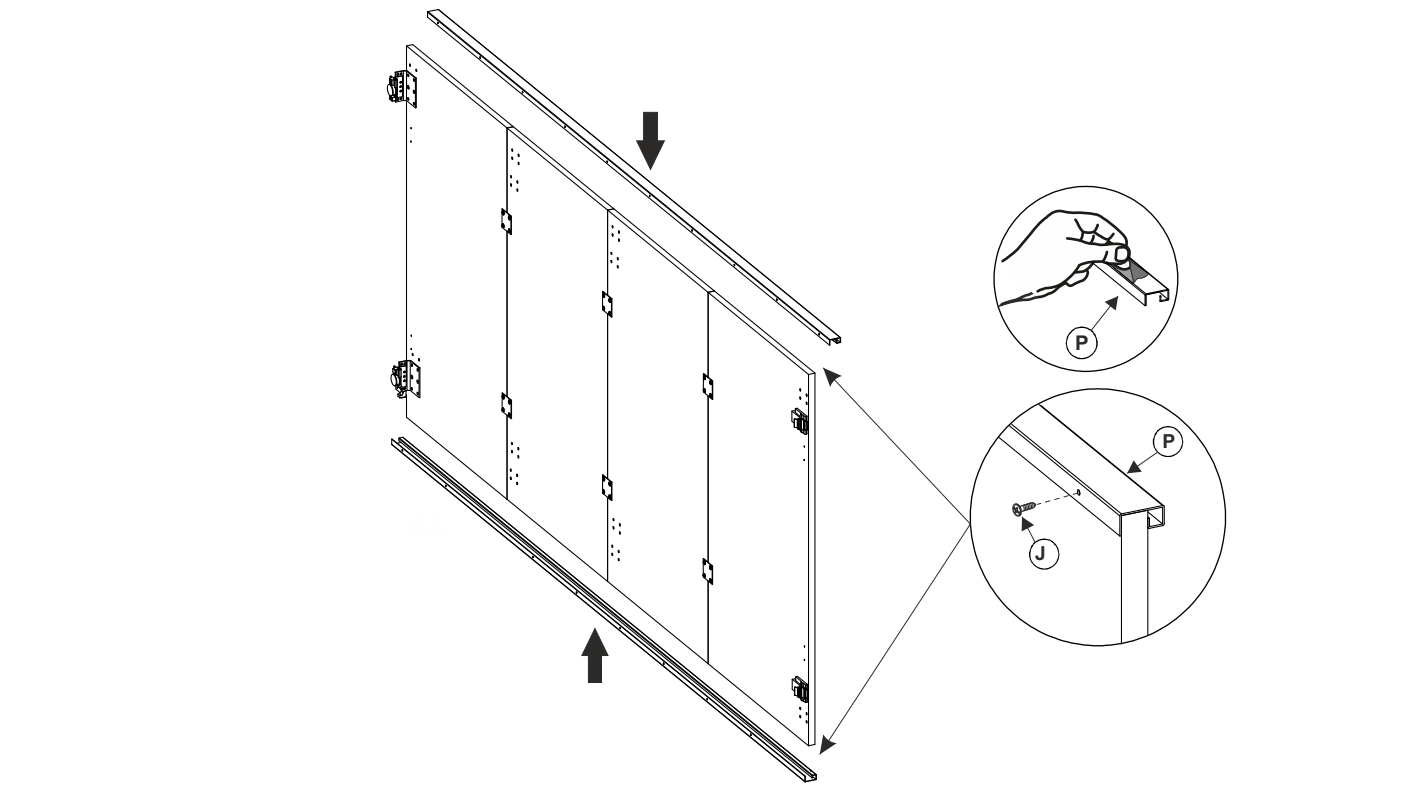
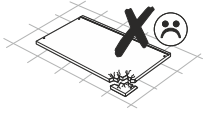
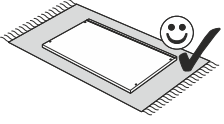

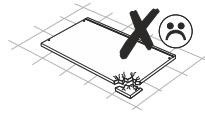
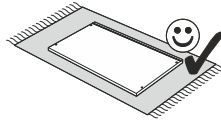
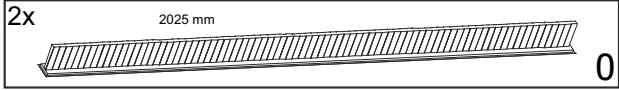

28

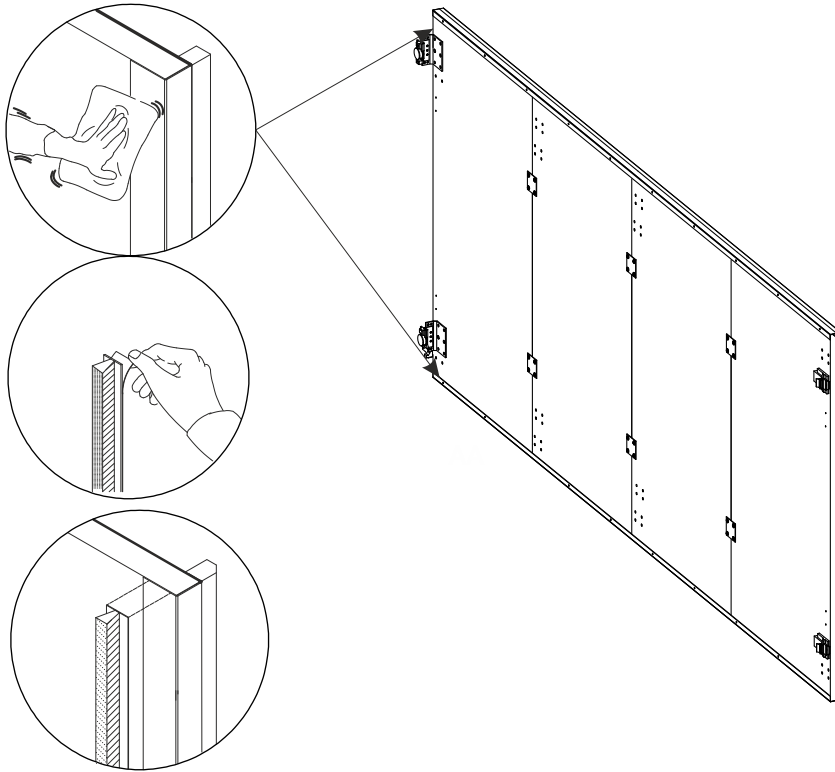

29

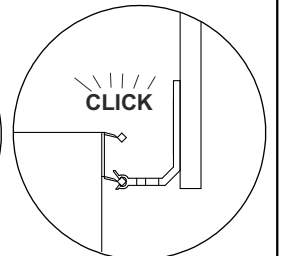
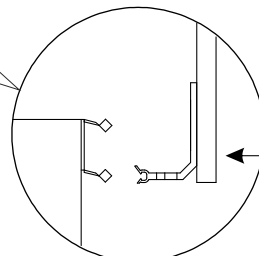
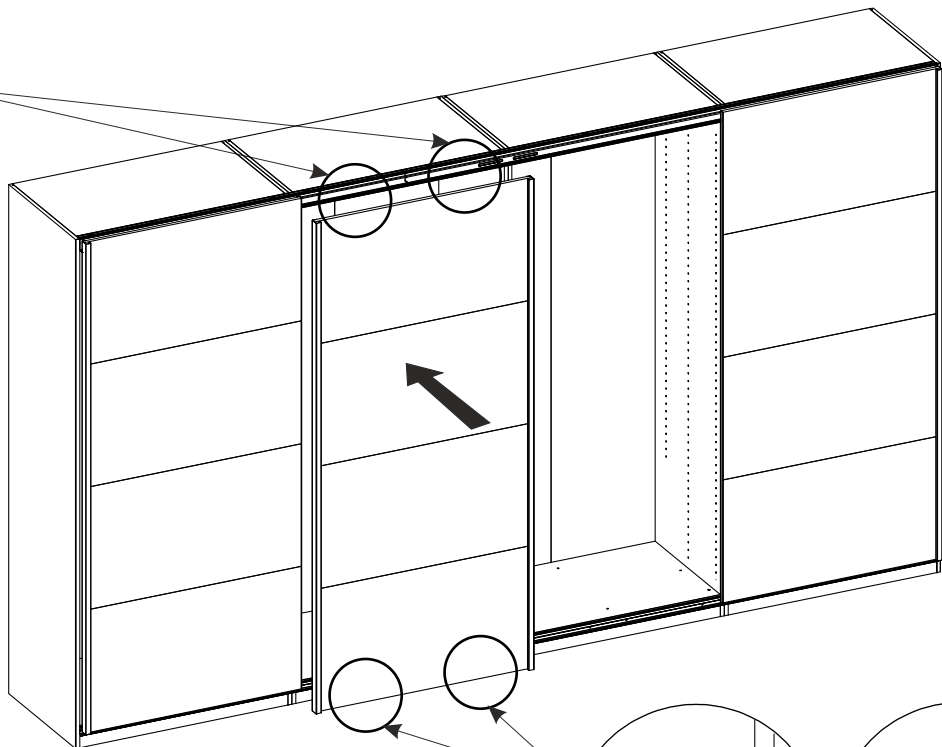
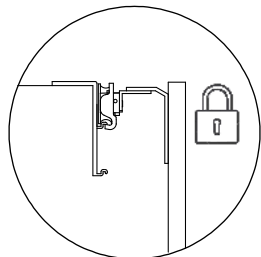
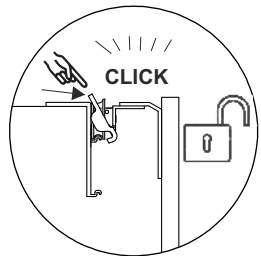
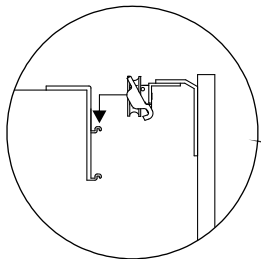

30

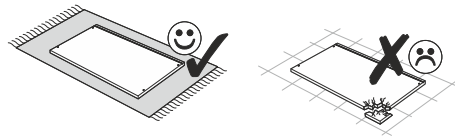
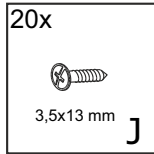
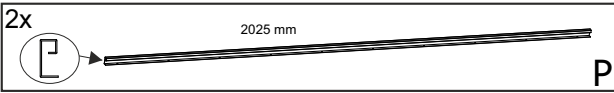
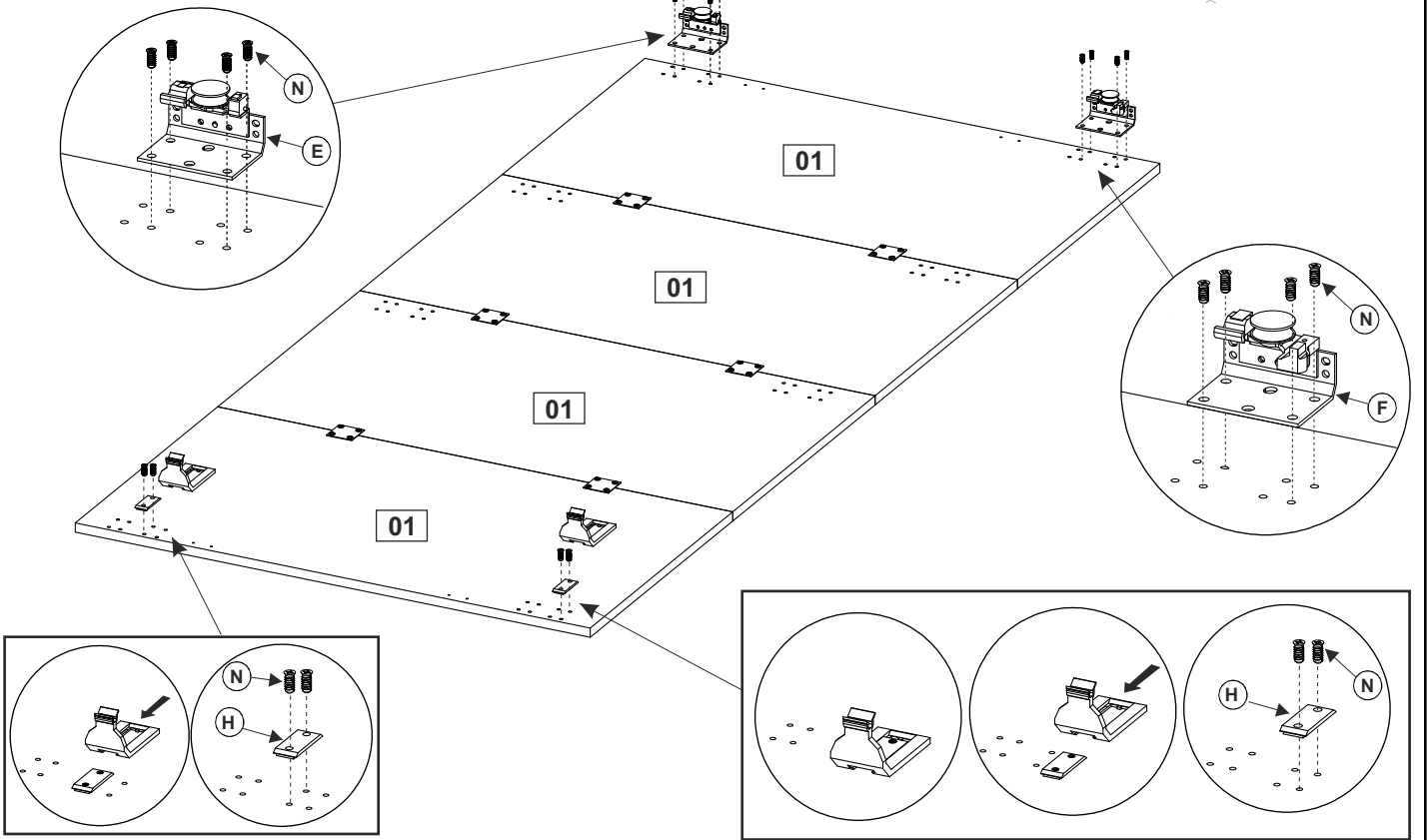
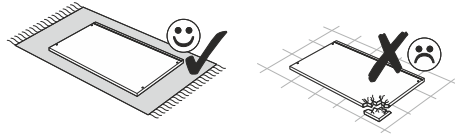
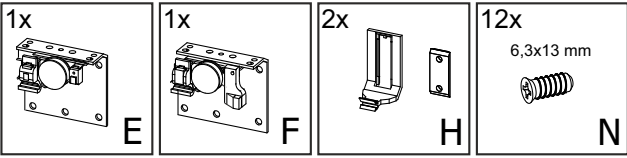

31

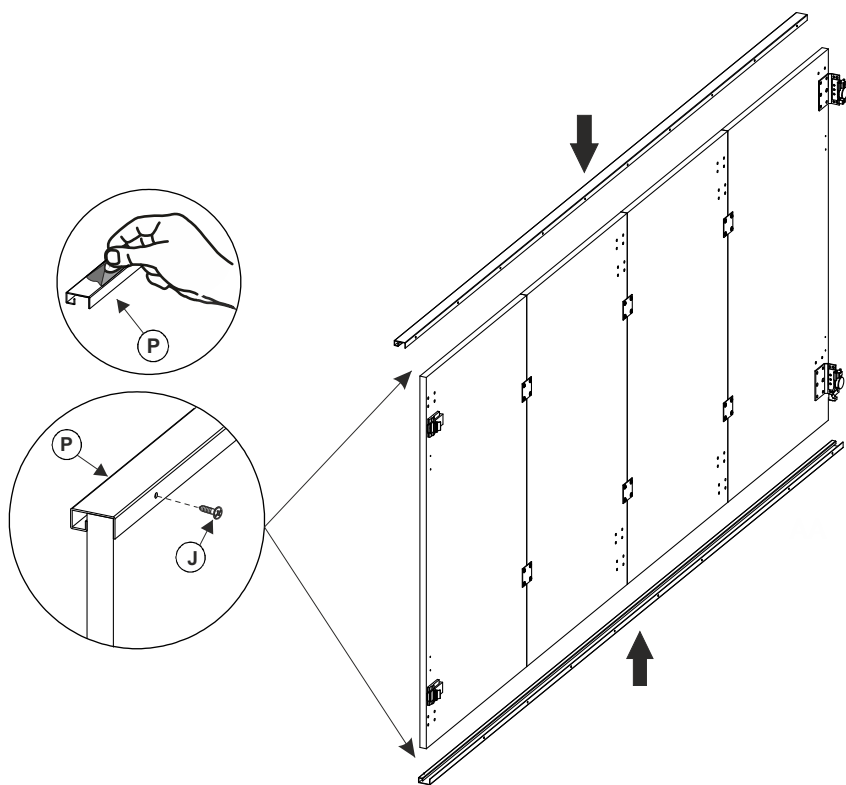

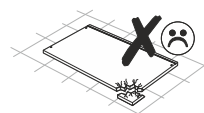
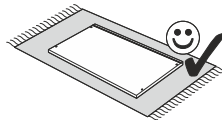
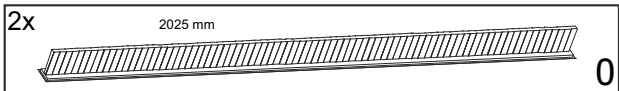

32

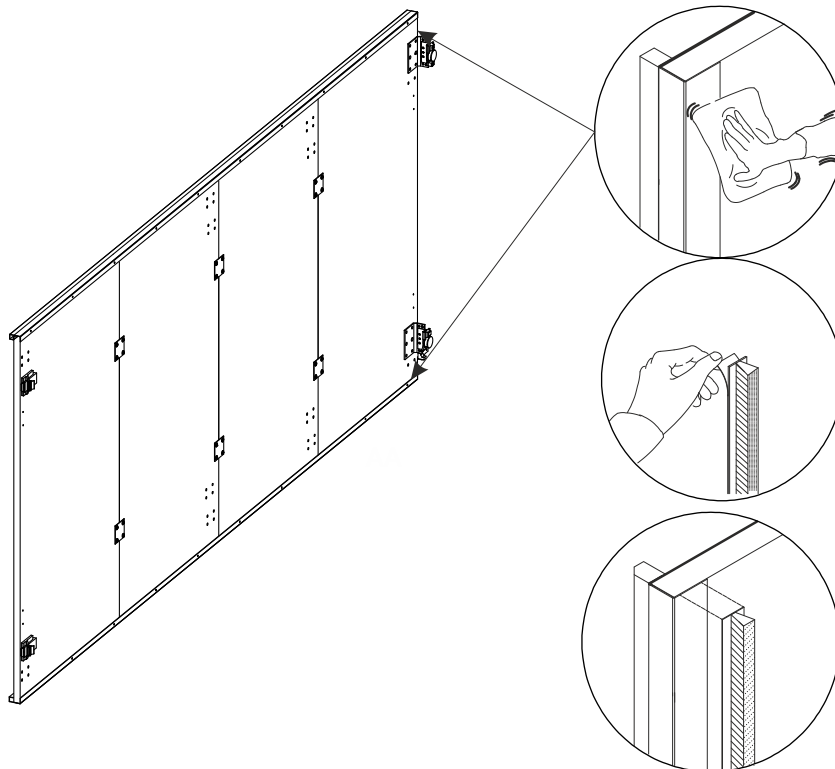

33

