









<b>B1</b>		φ8x28	x4
<b>T1</b>			x4
<b>M1</b>			x4
<b>K1</b>		5x60	x8
<b>G7</b>			x1
<b>C2</b>		φ20	x14
<b>F15</b>			x2
<b>S13</b>		4x35	x10

Nr	Ausmaß			St
1	2146	230	28	1
2	2146	230	28	1
3	2095	60	22	2
4	2745	229	28	1
5	2745	60	22	1



1

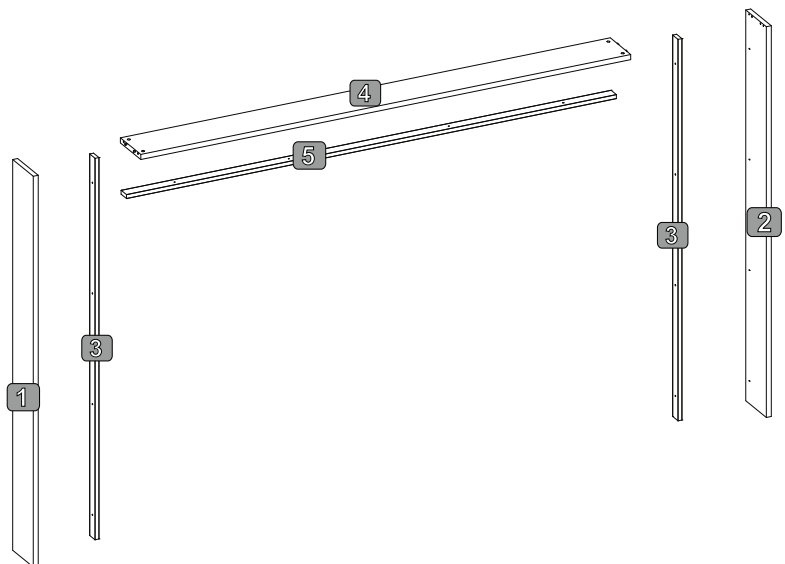
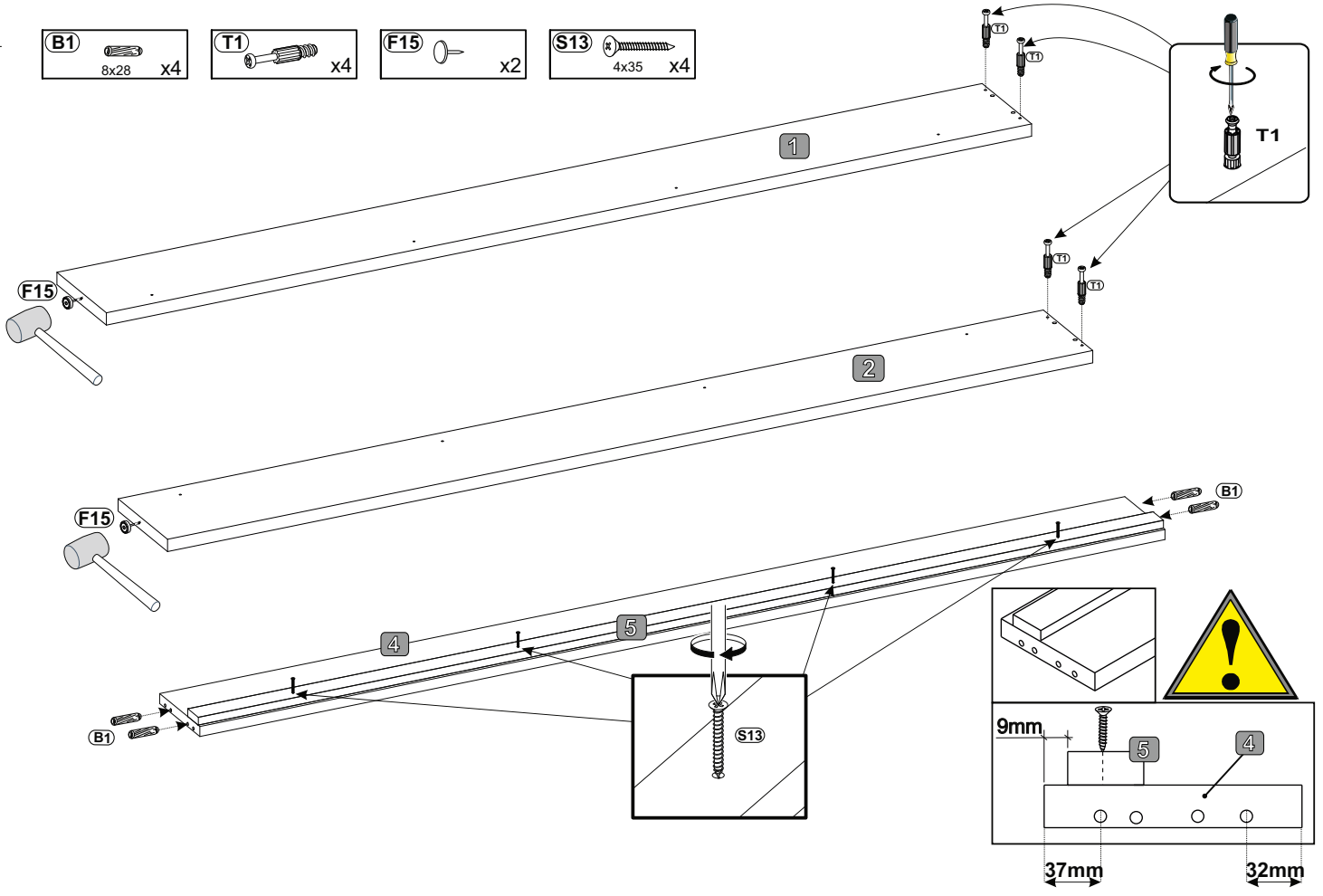
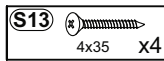
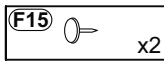
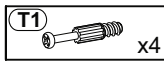
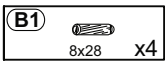

PASSEPARTOUT

58551

4/4

2

