

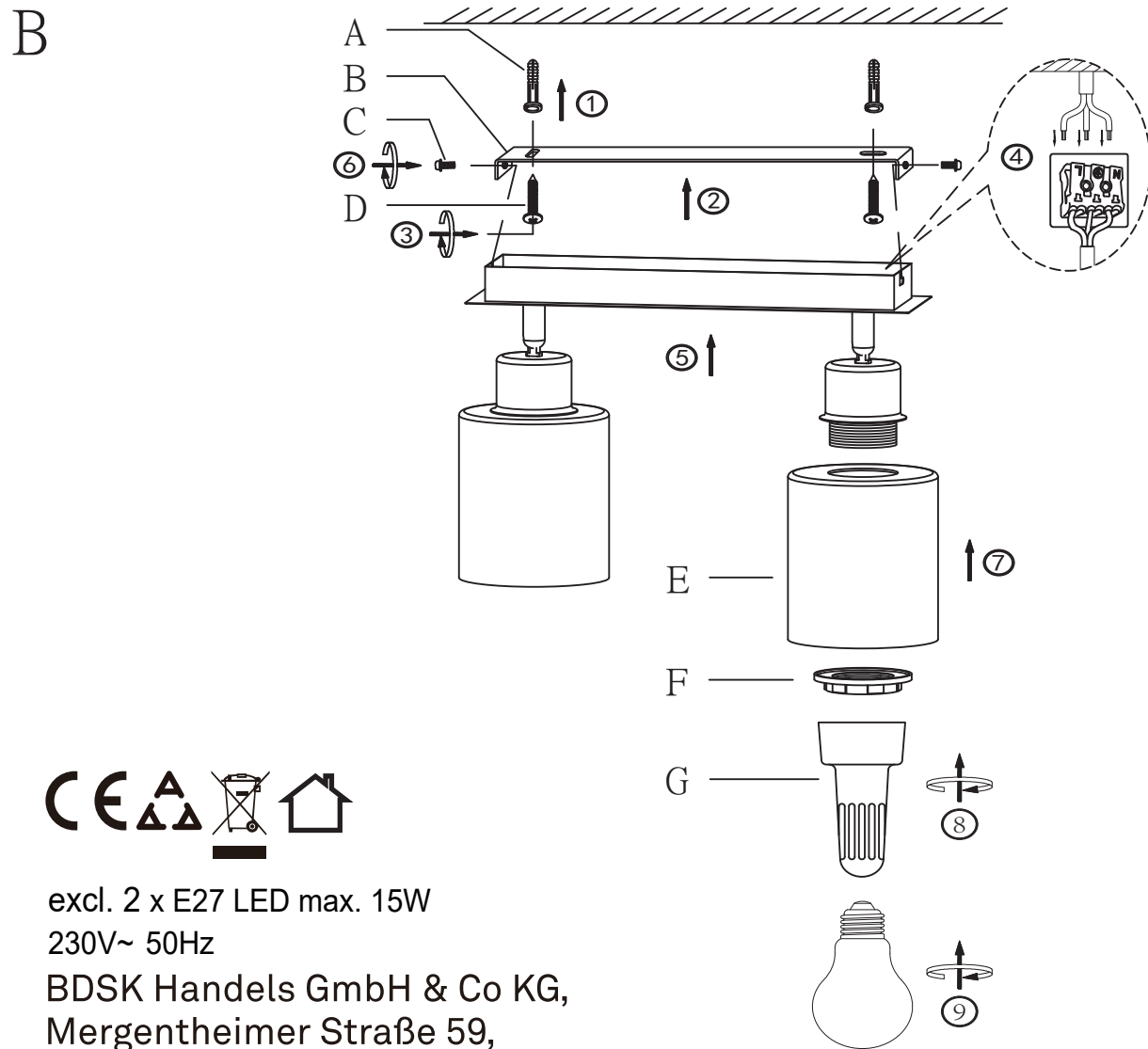

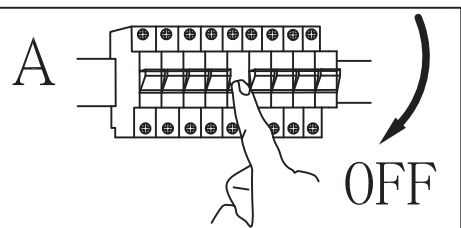



novel

81810195-02

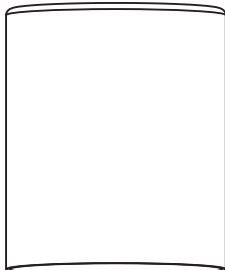

spare parts		
code	part	
A		X2
B		X1
C		X2
D		X2
E		X2
F		X2
G		X1

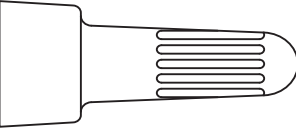

excl. 2 x E27 LED max. 15W
230V~ 50Hz

BDSK Handels GmbH & Co KG,
Mergentheimer Straße 59,
97084 Würzburg, Germany.
www.novel-living.com
info@xxxlutz.at

