

# FELIPE

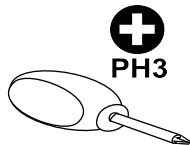

45min

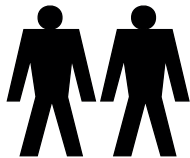

PH3

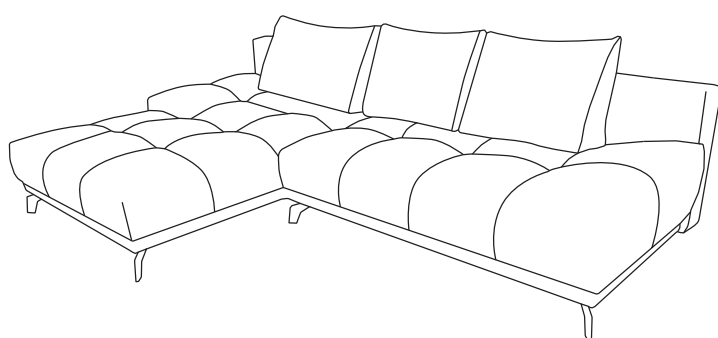
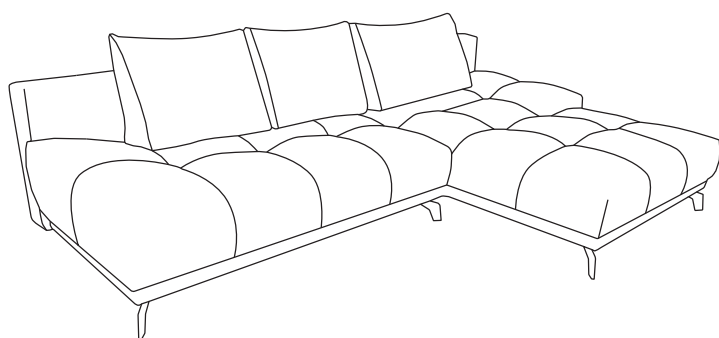

I

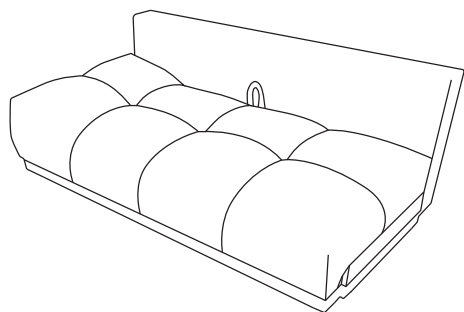

II

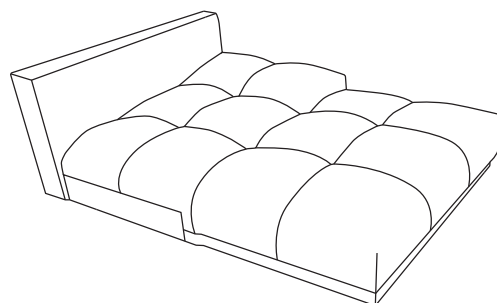

III

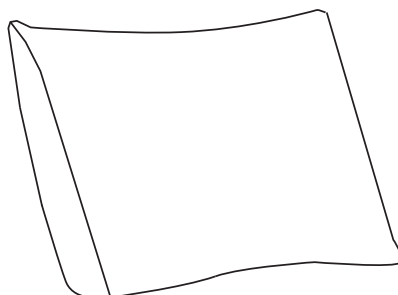

x3

**Ax4**

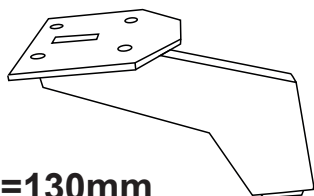

H=130mm

**Bx4**

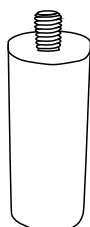

H=100mm

**Cx2**



H=130mm

**Dx16**

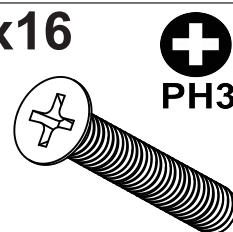

6x35

PH3

1

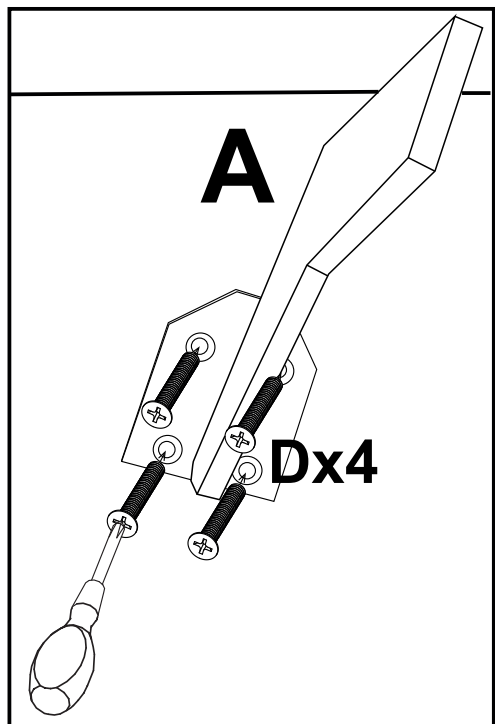
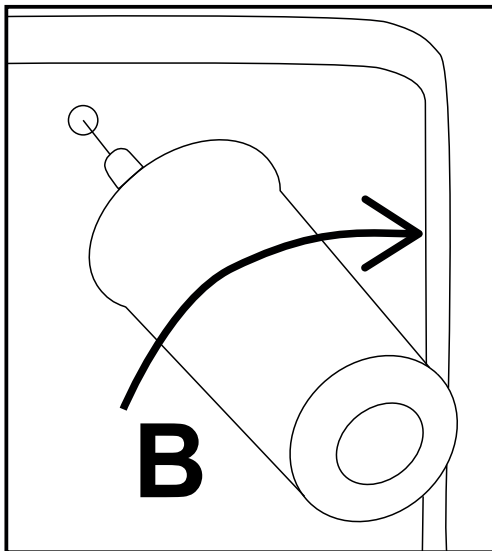
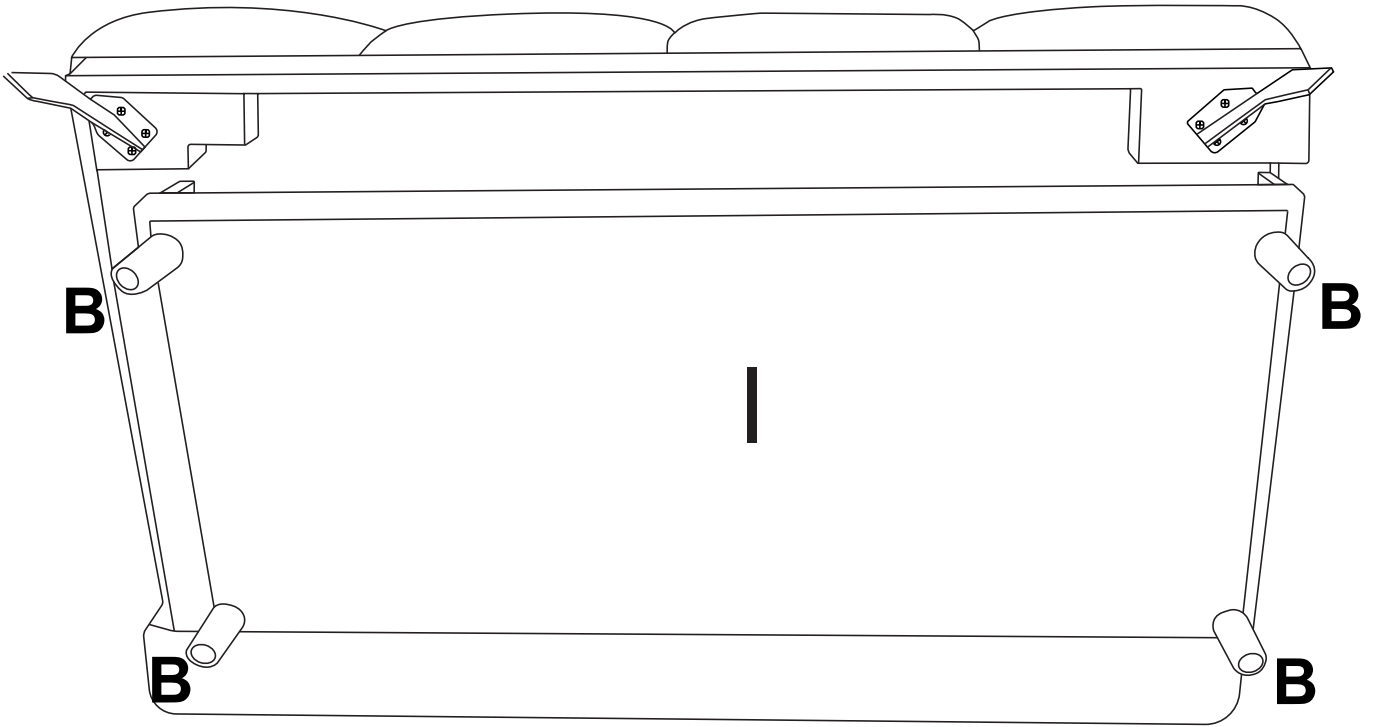
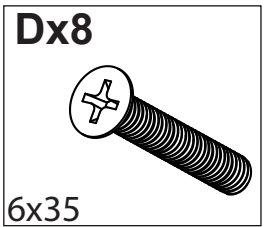
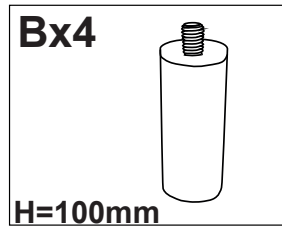
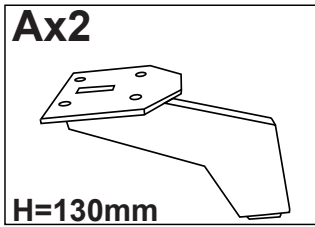

2

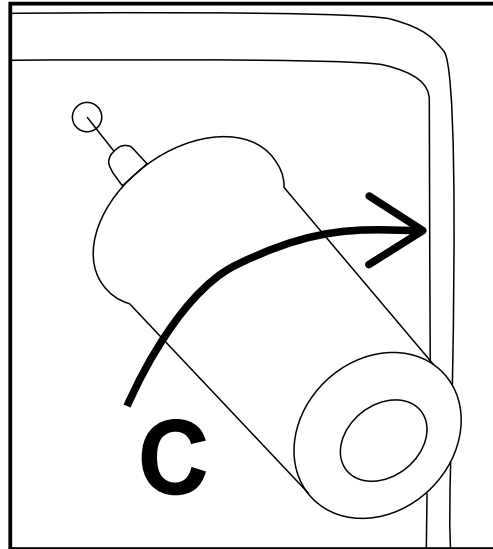
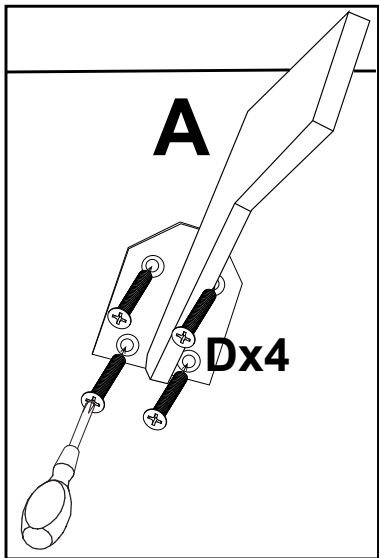
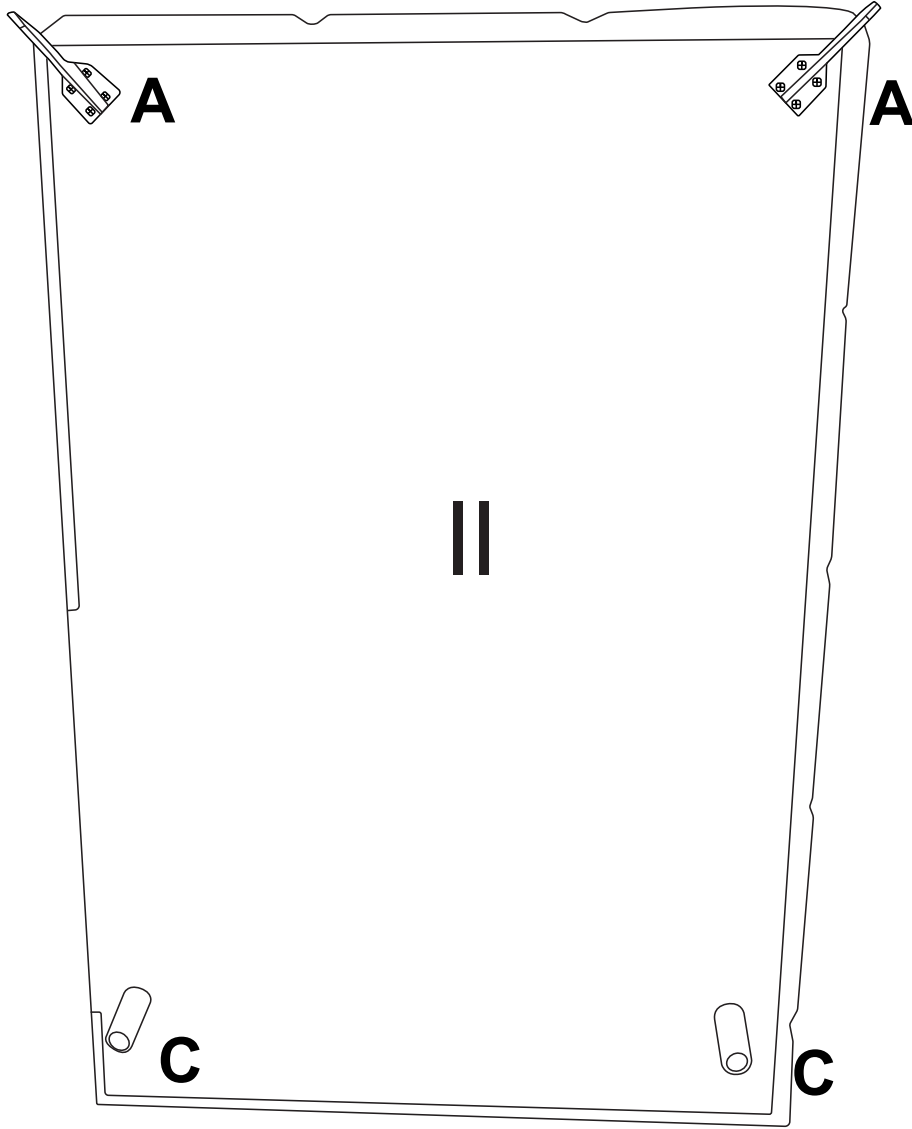
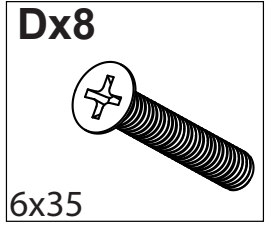
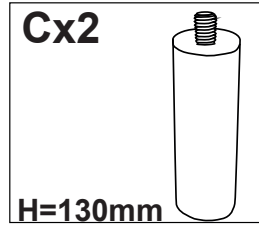
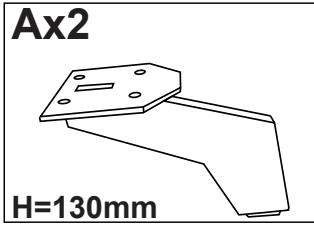

3

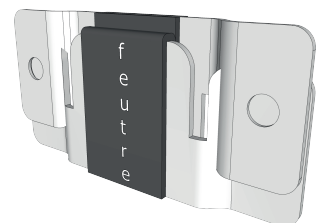
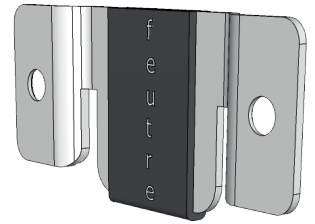
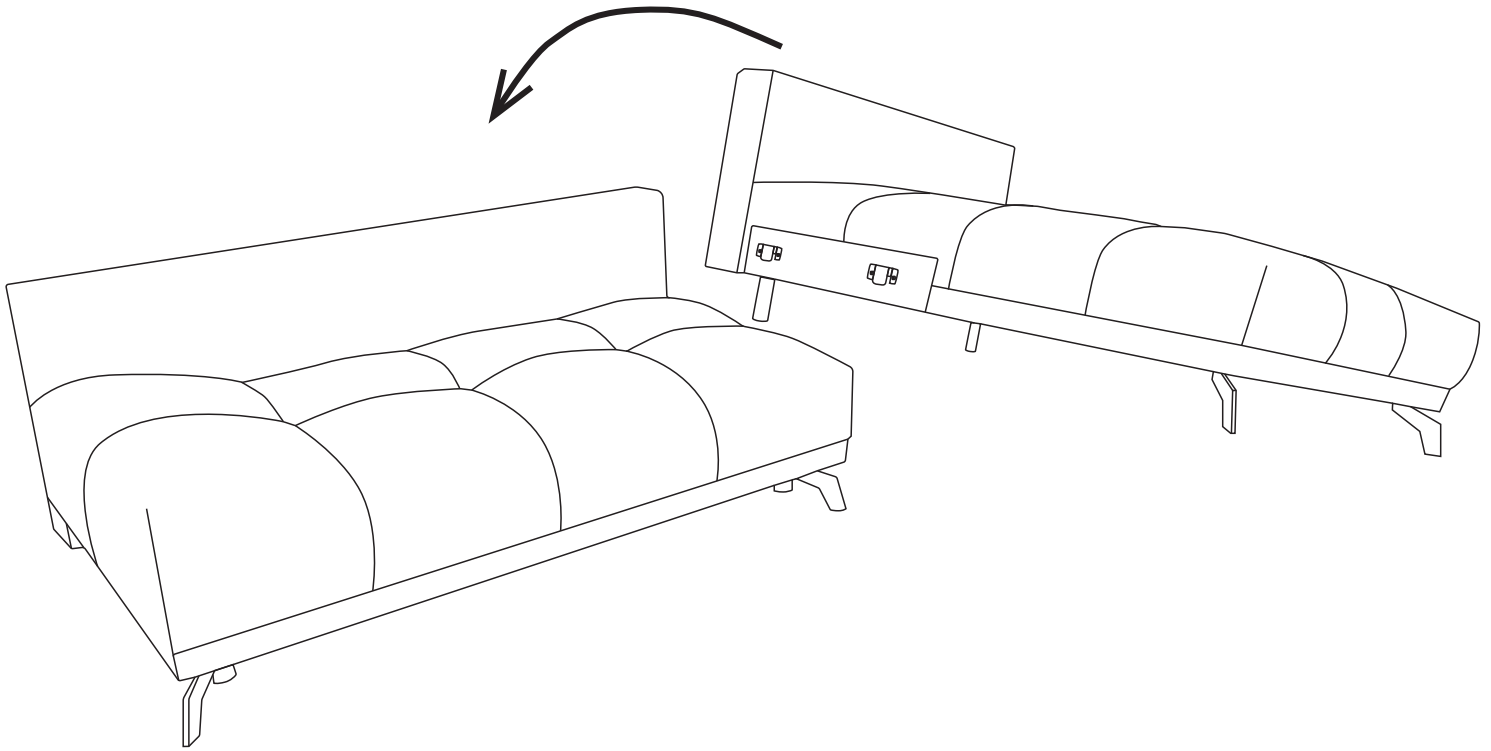

4

