

Montageanleitung Montážny návod MANHATTAN

Type/Typ **71/72/73/74/75/80**

MN 170/01

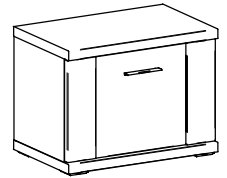
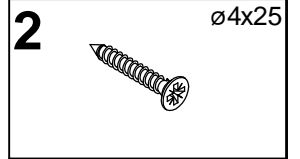
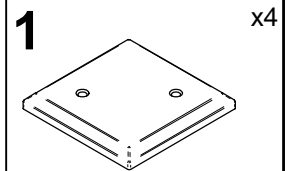

Typ 74

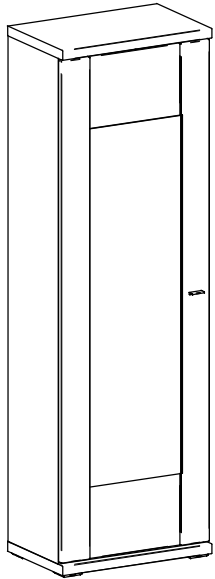

Typ 71

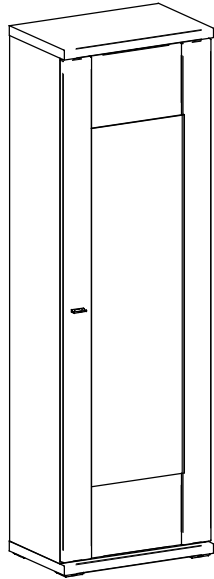

Typ 72

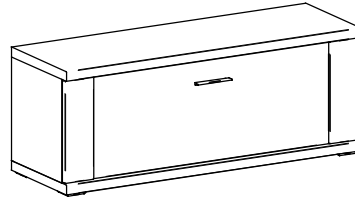

Typ 80

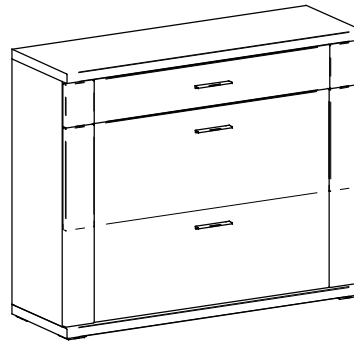

Typ 73

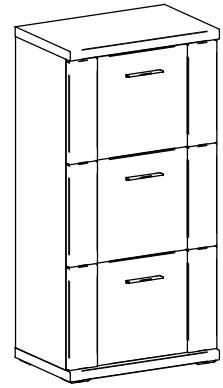

Typ 75

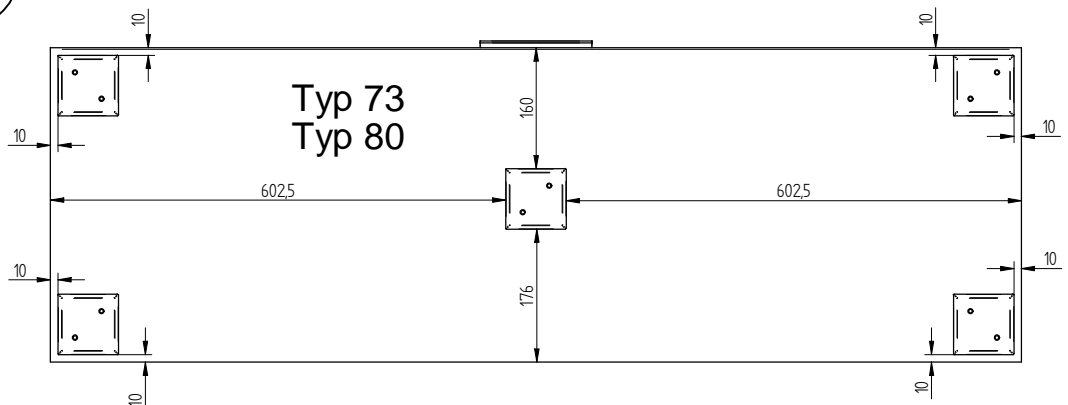
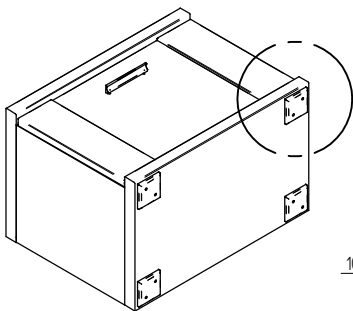
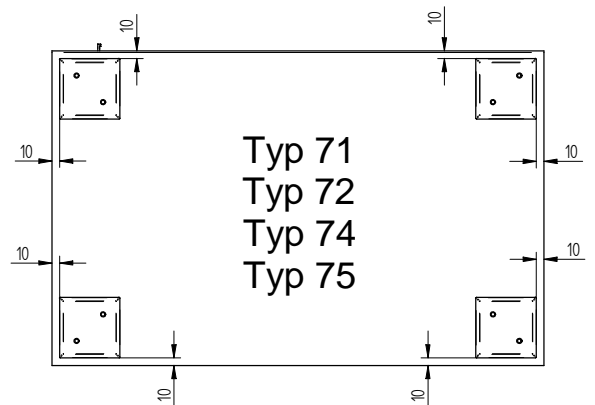
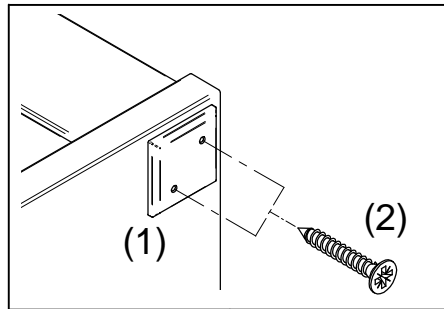

2 SICHERHEITSWINKEL (VERHINDERT DAS UMKIPPEN DES SCHRANKES) BEZPEČNOSTNÝ VINKEL (ZABRAŇUJE PREVRHNUTIU SKRINKY)

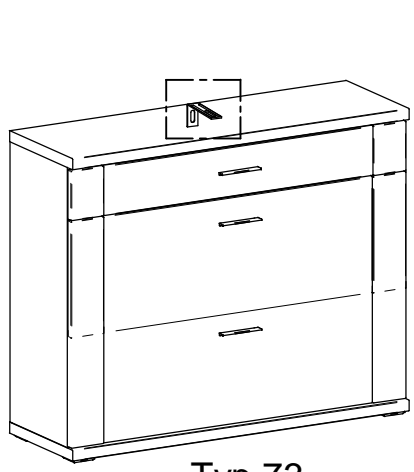
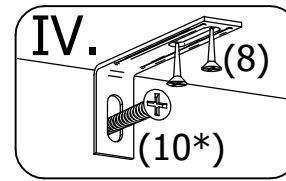
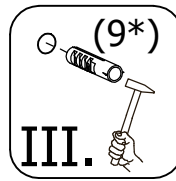
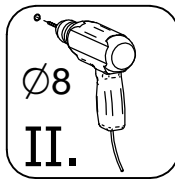
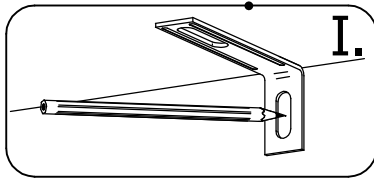

Typ 73

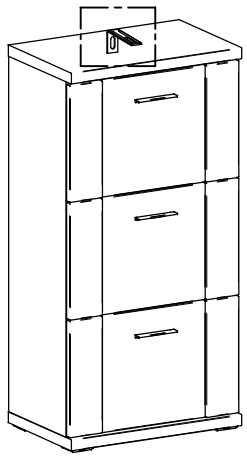

Typ 75

<p>3 1x</p>	<p>4 2x</p> <p>ø3,5x15</p>
<p>5</p> <p>ø10x50</p>	<p>6</p> <p>ø5x60</p>

* NICHT BEINHÄLTET IM BESCHLAGBEUTEL!
* NIE JE SÚČASŤOU KOVANIA!

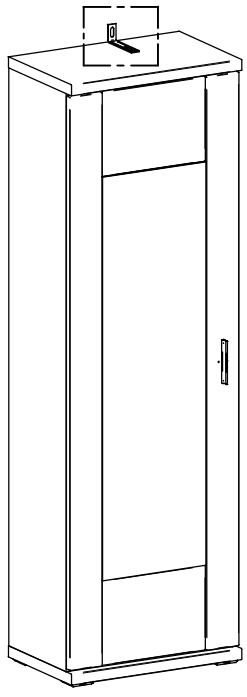

Typ 71

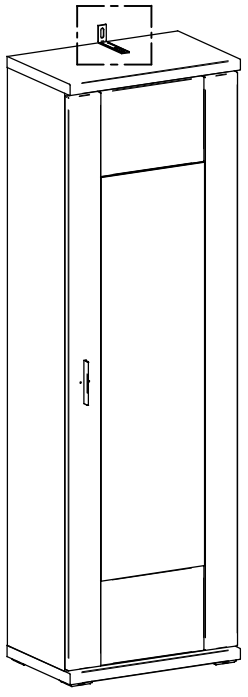

Typ 72

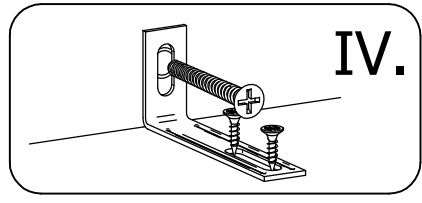
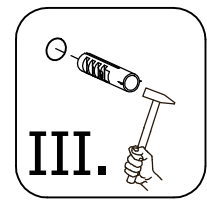
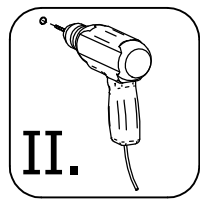
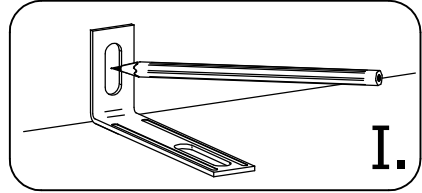

WICHTIGER HINWEIS

Schraube (4*) ist für die Befestigung des Sicherheitswinkels (3*) auf dem Schrank bestimmt. Des weiteren werden Sie noch Schraube (6) und Dübel (5) für die Befestigung des Sicherheitswinkels in die Mauer (Wand) gebrauchen. Schraube und Dübel wählen Sie bitte nach dem Material, aus dem die Mauer (Wände) bestehen. Falls Sie sich nicht sicher sind, welche Schraube (6) und Dübel (5) Sie gebrauchen, wenden Sie bitte an nächsten Fachhandel.

DÔLEŽITÉ UPOZORNENIE

Skrutka (4*) je určená na upevnenie bezpečnostného kovania (3*) ku skrinke. Okrem toho budete potrebovať skrutku (6) a hmoždinku (5) na pripevnenie kovania k stene. Tieto si zvolte podľa druhu steny. Ak nie ste si istý, aký druh skrutky a hmoždinky potrebujete, kontaktujte najbližšie železiarstvo.

3 MONTAGE DES GRIFFES / MONTÁŽ ÚCHYTKY

Typ 71,72,73,74,75,80

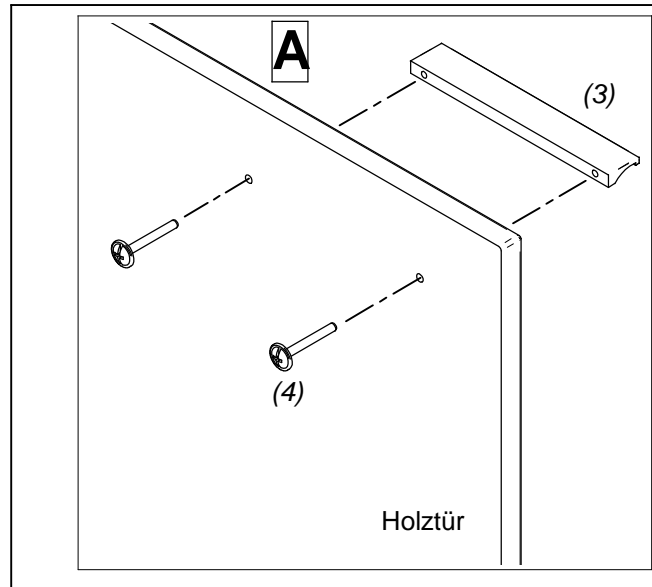
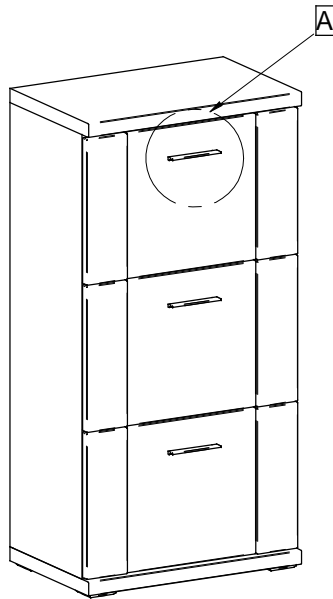
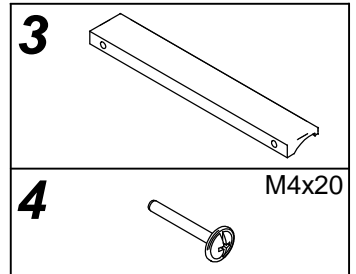

Einstellung von Türen / Nastavenie dverí

<p>Schritt krok 1-3</p> <p>Schritt krok 2</p> <p>Schritt krok 1-3</p>	<p>Schritt krok 1-3</p> <p>Schritt krok 2</p>	<p>Schritt krok 1</p> <p>Schritt krok 1</p>
<p>1. Die Schraube B lösen 2. Tür in der Höhe einstellen 3. Die Schraube B zuziehen</p> <p>1. skrutku B povoliť 2. dvere výškovo nastaviť 3. skrutku B dotiahnuť</p>	<p>1. Die Schraube A lösen 2. Tür in der Tiefe einstellen 3. Die Schraube A zuziehen</p> <p>1. skrutku A povoliť 2. dvere hlbkovo nastaviť 3. skrutku A dotiahnuť</p>	<p>1. Tür seitligs mit Schraube C einstellen</p> <p>1. dvere stranovo skrutkou C nastaviť</p>
<p>+ 2 mm - 2 mm</p>	<p>+ 3 mm - 1 mm</p>	<p>+ 5 mm - 1,5 mm</p>