

A	B	C (mm)		D	A	B	C (mm)		D	A	B	C (mm)		D
1	L51-0005	2082	450	6/7	11	L51-3005	891	545	3/7	21	L51-5017	1444	80	5/7
2	L51-0006	2082	450	6/7	12	L51-3006	965	549	3/7	22	L51-5018	1444	80	5/7
3	L51-0007	1634	450	7/7	13	L51-3007	892	549	3/7	23	L51-9004	865	505	4/7
4	L51-0008	1634	450	7/7	14	L51-3008	965	565	4/7	24	L51-9303	2226	899	1/7
5	L51-0009	904	220	6/7	15	L51-3009	965	565	4/7	25	L51-9304	2226	973	2/7
6	L51-0010	2082	450	7/7	16	L51-3010	892	565	4/7	26	ZS3-5601	843	140	6/7
7	L51-1009	2248	565	1/7	17	L51-3011	965	565	4/7	27	ZS5-503	500	140	4/7
8	L51-1010	2248	565	1/7	18	L51-3012	965	565	4/7	28	ZS5-504	500	140	4/7
9	L51-1011	2248	565	2/7	19	L51-3013	892	565	4/7	29	dr-960	960	30	4/7
10	L51-1012	2248	565	2/7	20	L51-5016	2250	80	5/7					

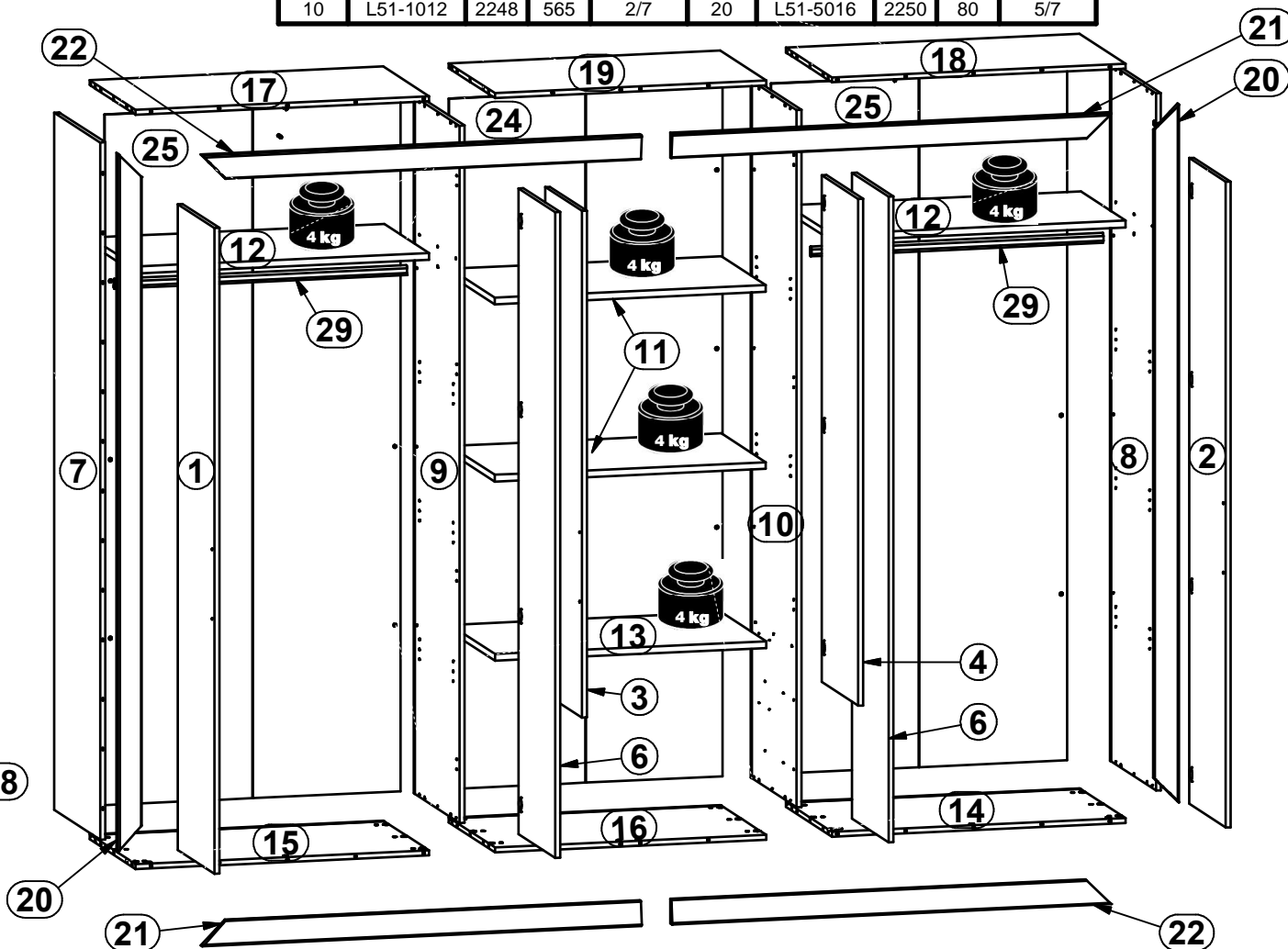

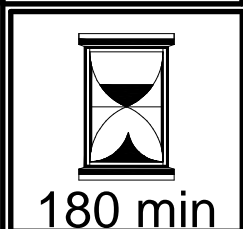

6x a68	8x a103	8x a132	4x a133	cm 0 1 2 3 4 5 6 7 8 9 10							6x b35	8x b43	8x b59	5x c34412
8x Ø5x17 mm d1	24x d20	18x d28	16x Ø6,3x13 mm e2	12x Ø6x13 mm e3	12x Ø5x9 mm e19	24x Ø6,3x10 mm e50	18x Ø6,3x10 mm e51	52x Ø8x30 mm f1	4x Ø6x30 mm f9	8x Ø6,5x40 mm f25	8x Ø8x40 mm f41	11x k43		
36x l2	4x n158	12x Ø3,5x13 mm p1	2x Ø3,5x16 mm p25	2x Ø3,5x10 mm p35	16x Ø3,5x16 mm p38	44x Ø3,5x15 mm p51	8x Ø4x22 mm p56	10x Ø3,5x30 mm p78	42x Ø15x12 mm #16 r1	6x r10	8x Ø12x10,5 mm #12 r15	38x r42		
36x r37	36x Ø20x13,5 mm #19 r54	28x Ø16 s2	2x 500 mm t34	2x 500 mm w26\ICR	2x 500 mm w26\ICL	2x 500 mm w26\IDL	2x 500 mm w26\IDR	4x w112\1	4x w112\2	2x Ø10x50 mm f35	2x 86x21x151,5 n14\2	2x Ø5x60 mm p17		

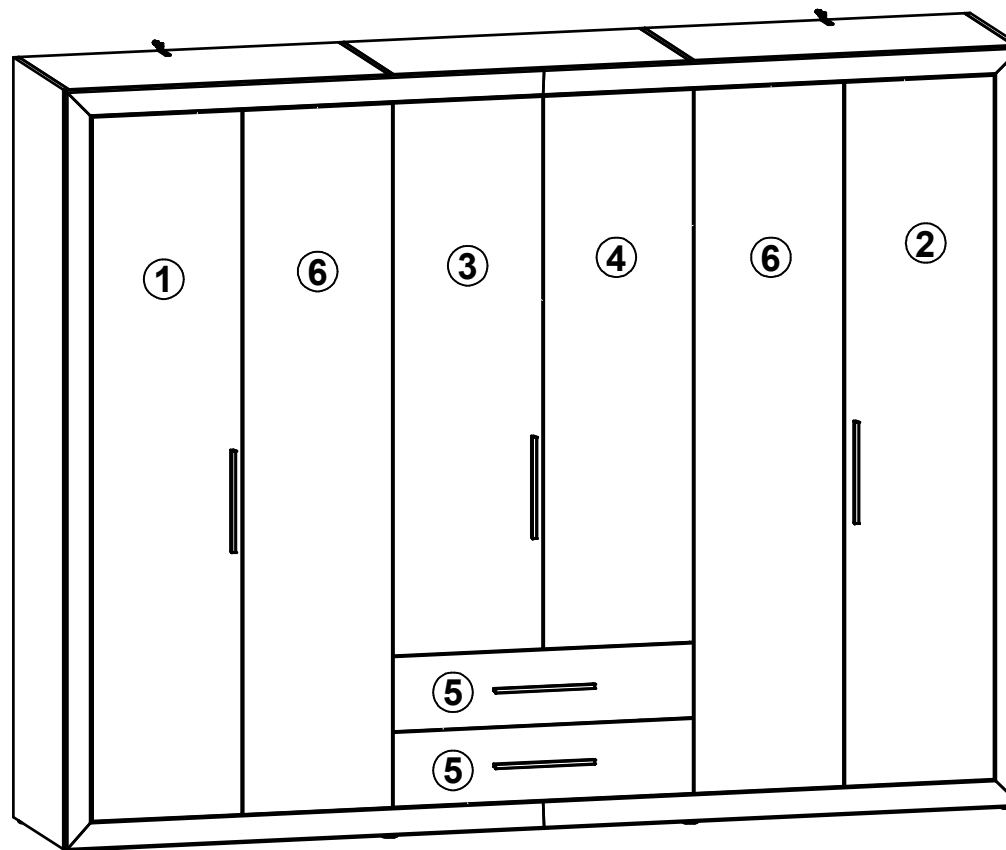
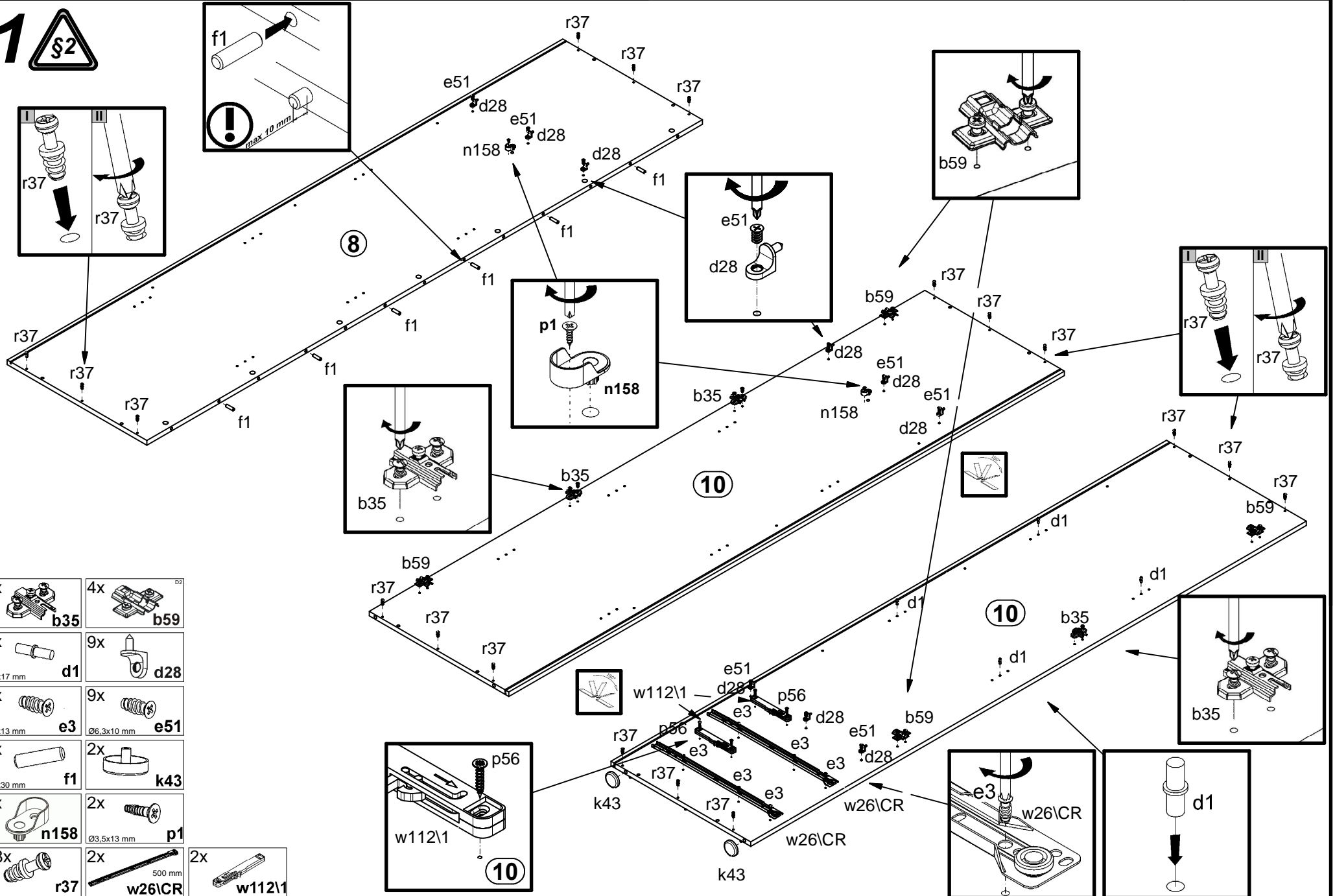
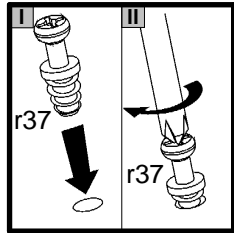
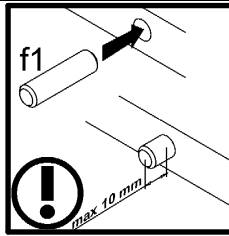

- 3x **b35**
- 4x **b59**
- 4x **d1**
Ø5x17 mm
- 9x **d28**
- 6x **e3**
Ø6x13 mm
- 9x **e51**
Ø6.3x10 mm
- 6x **f1**
Ø8x30 mm
- 2x **k43**
- 2x **n158**
- 2x **p1**
Ø3.5x13 mm
- 18x **r37**
- 2x **w26\CR**
500 mm
- 2x **w112\1**

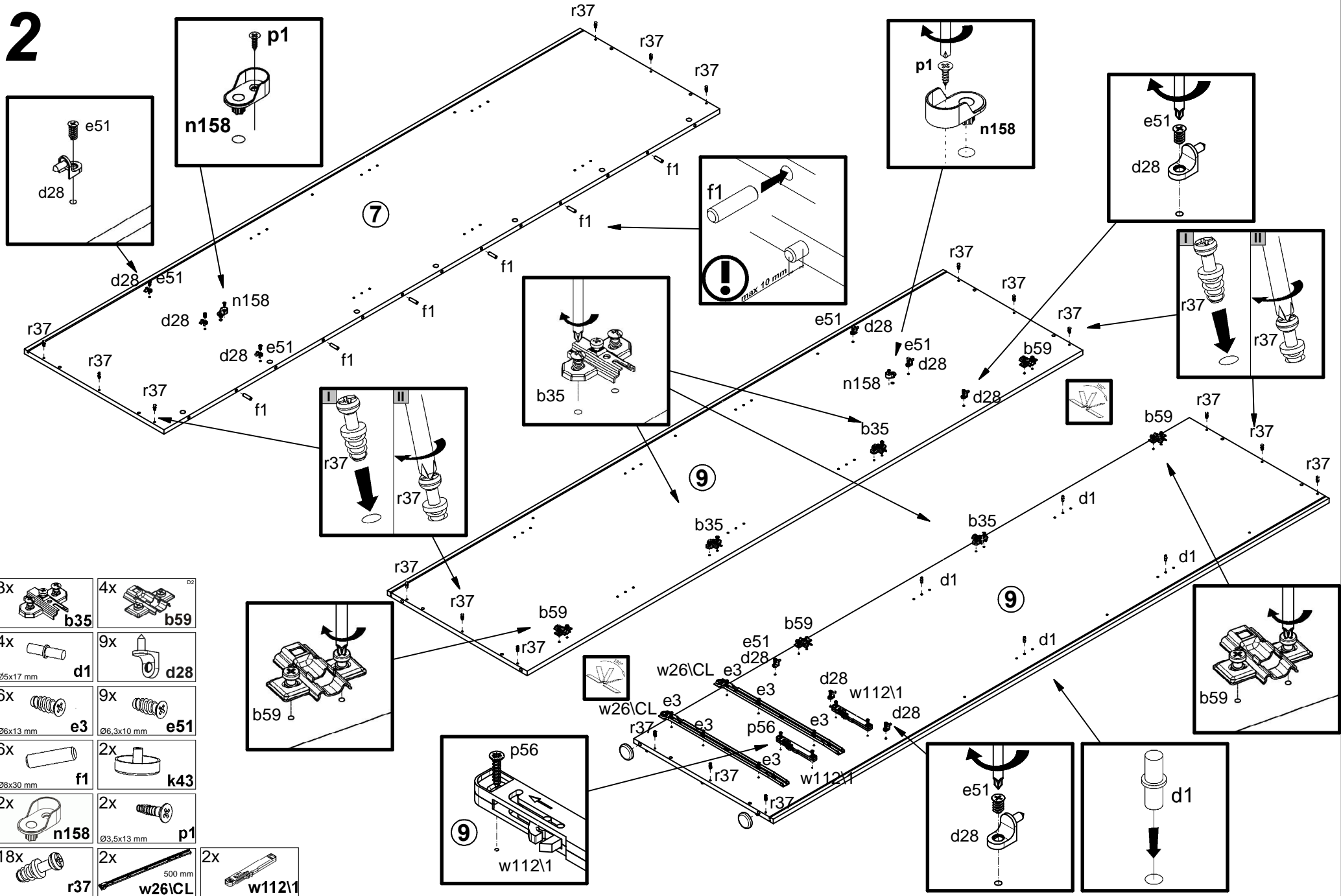

2



- | | | |
|-----|----|----|
| 3x | 4x | |
| | | |
| 4x | 9x | |
| | | |
| 6x | 9x | |
| | | |
| 6x | 2x | |
| | | |
| 2x | 2x | |
| | | |
| 18x | 2x | 2x |
| | | |

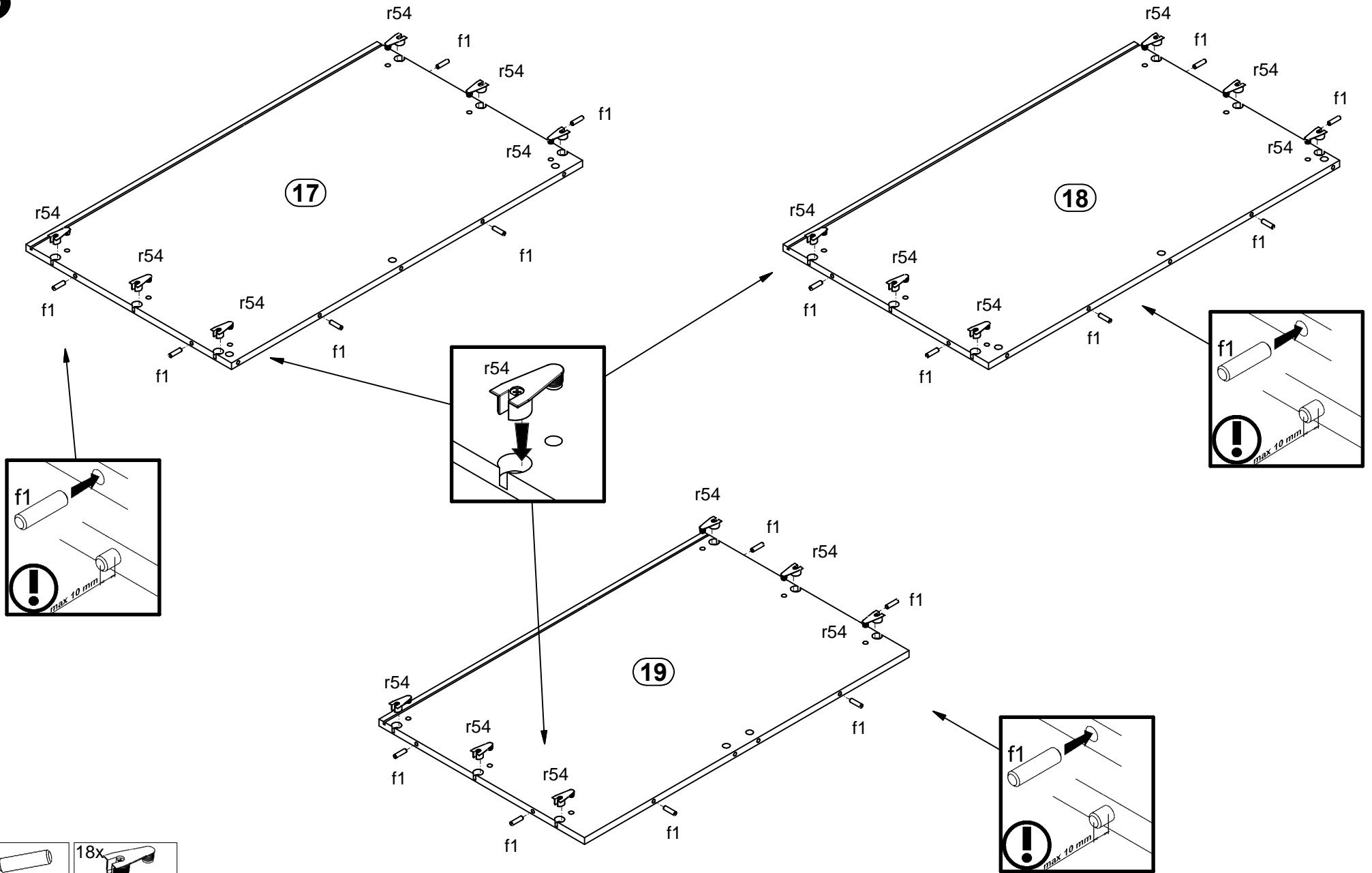

3

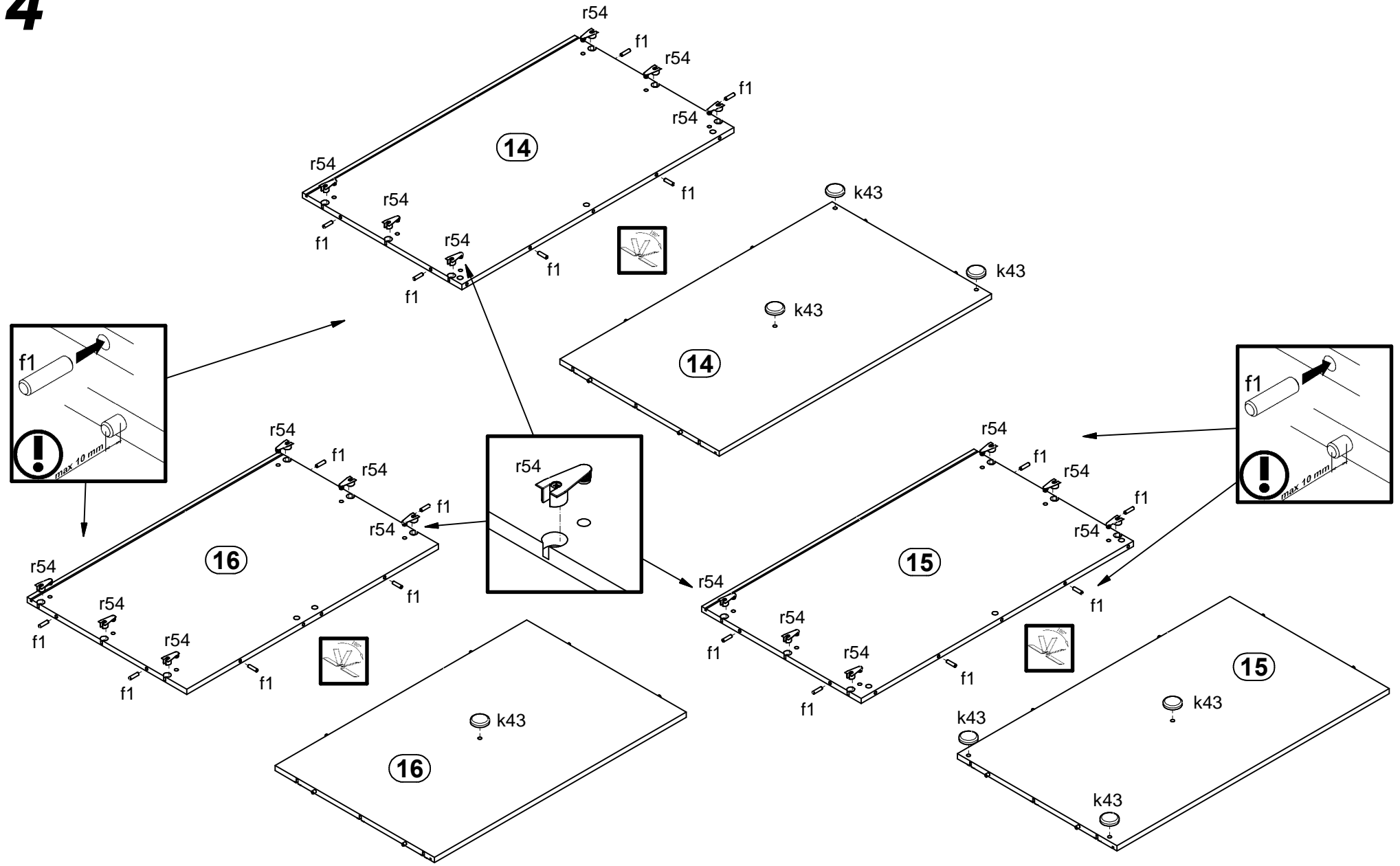

- 18x  f1
Ø8x30 mm
- 18x  r54
Ø20x13.5 mm #19

4



- 18x  f1
- 7x  k43
- 18x  r54

5

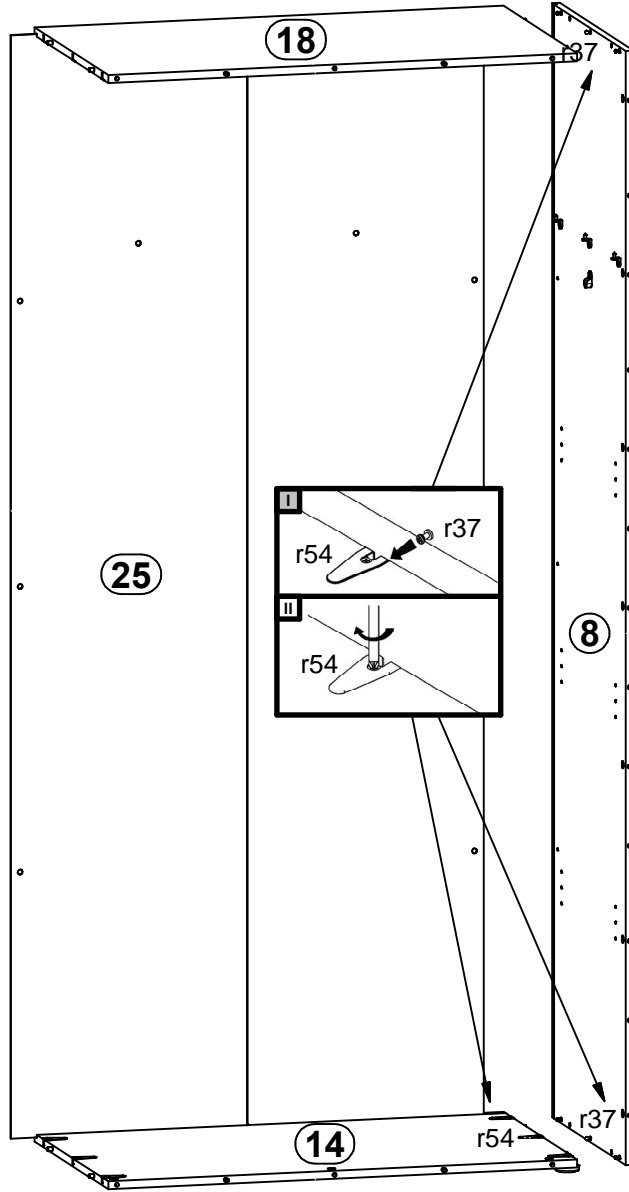

6

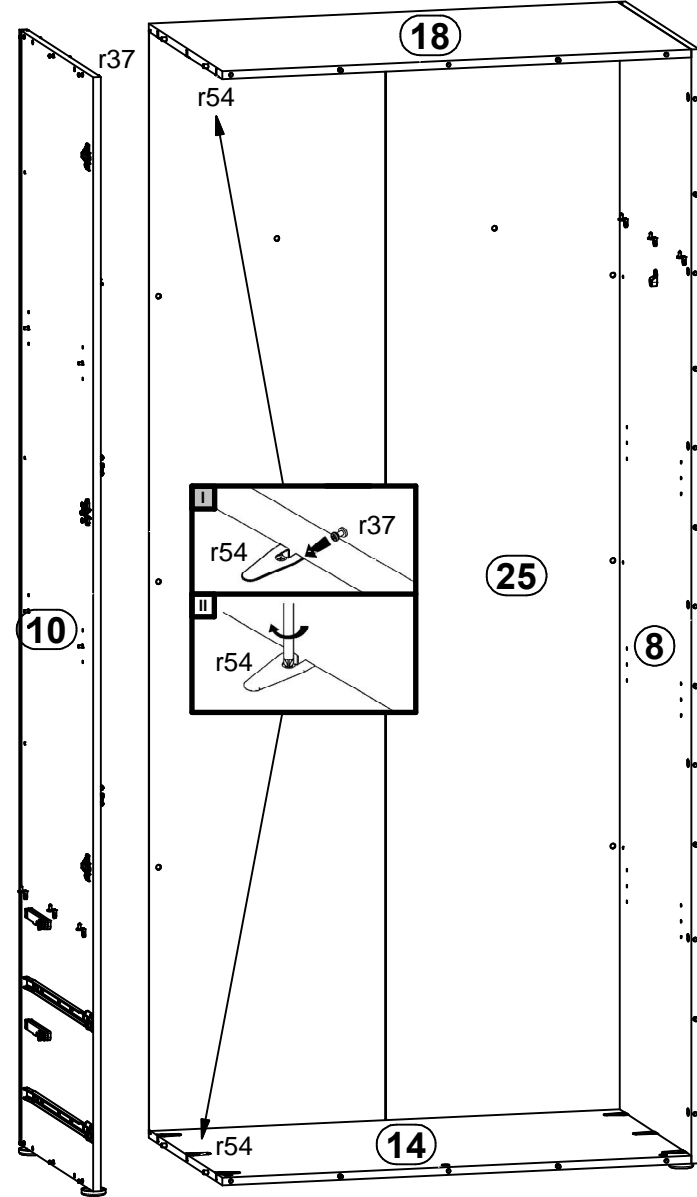

7

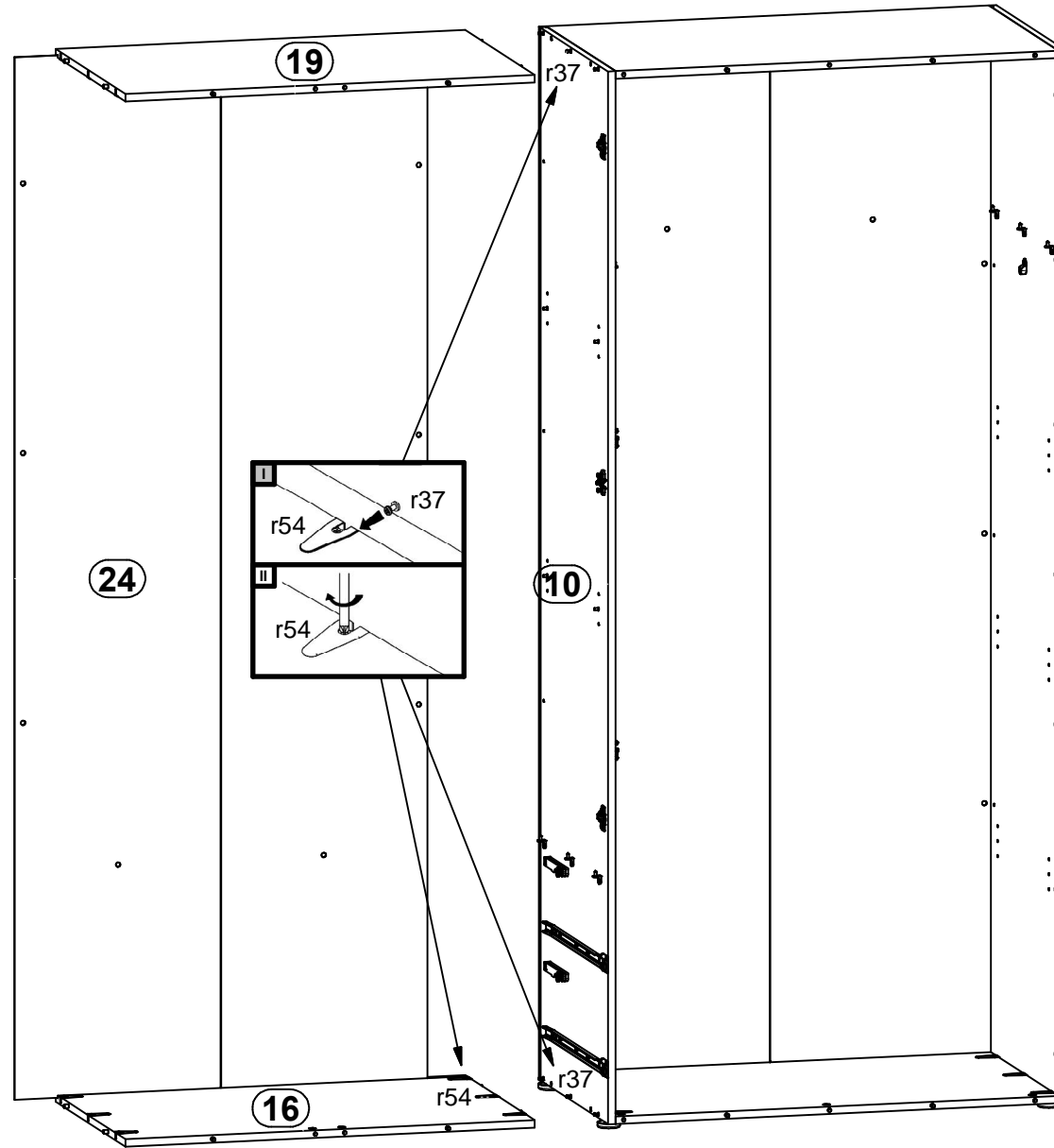

8

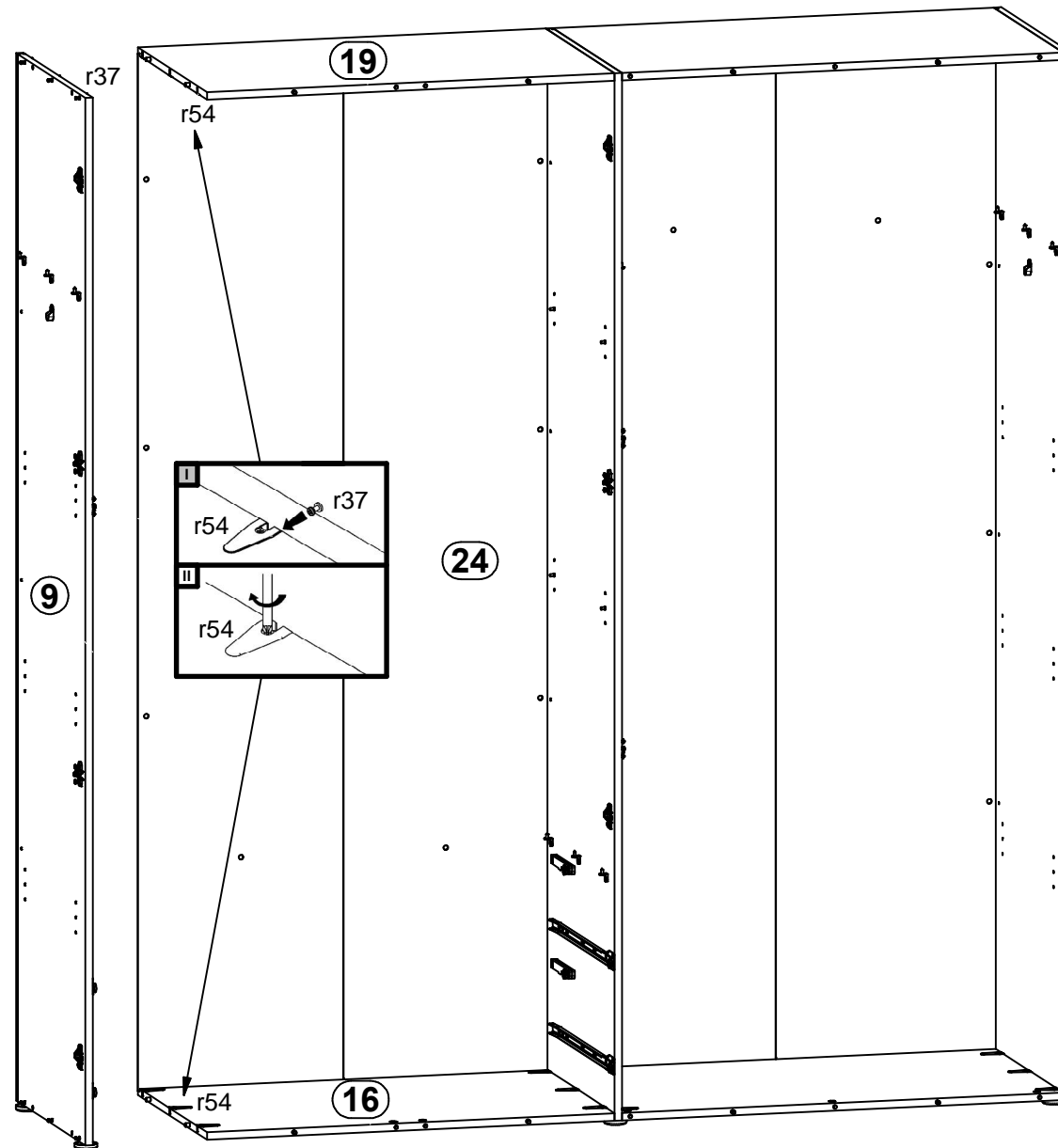

9

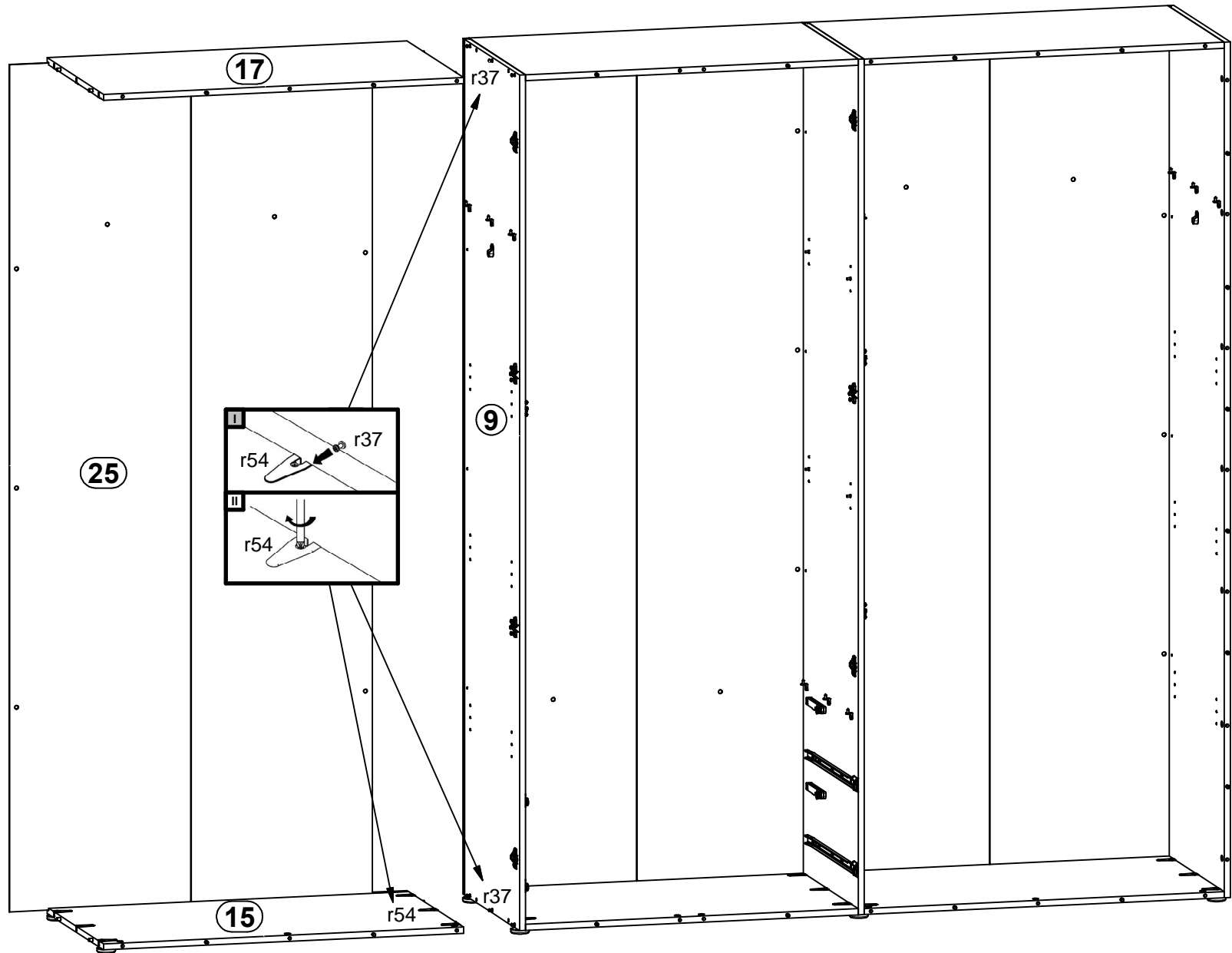

10

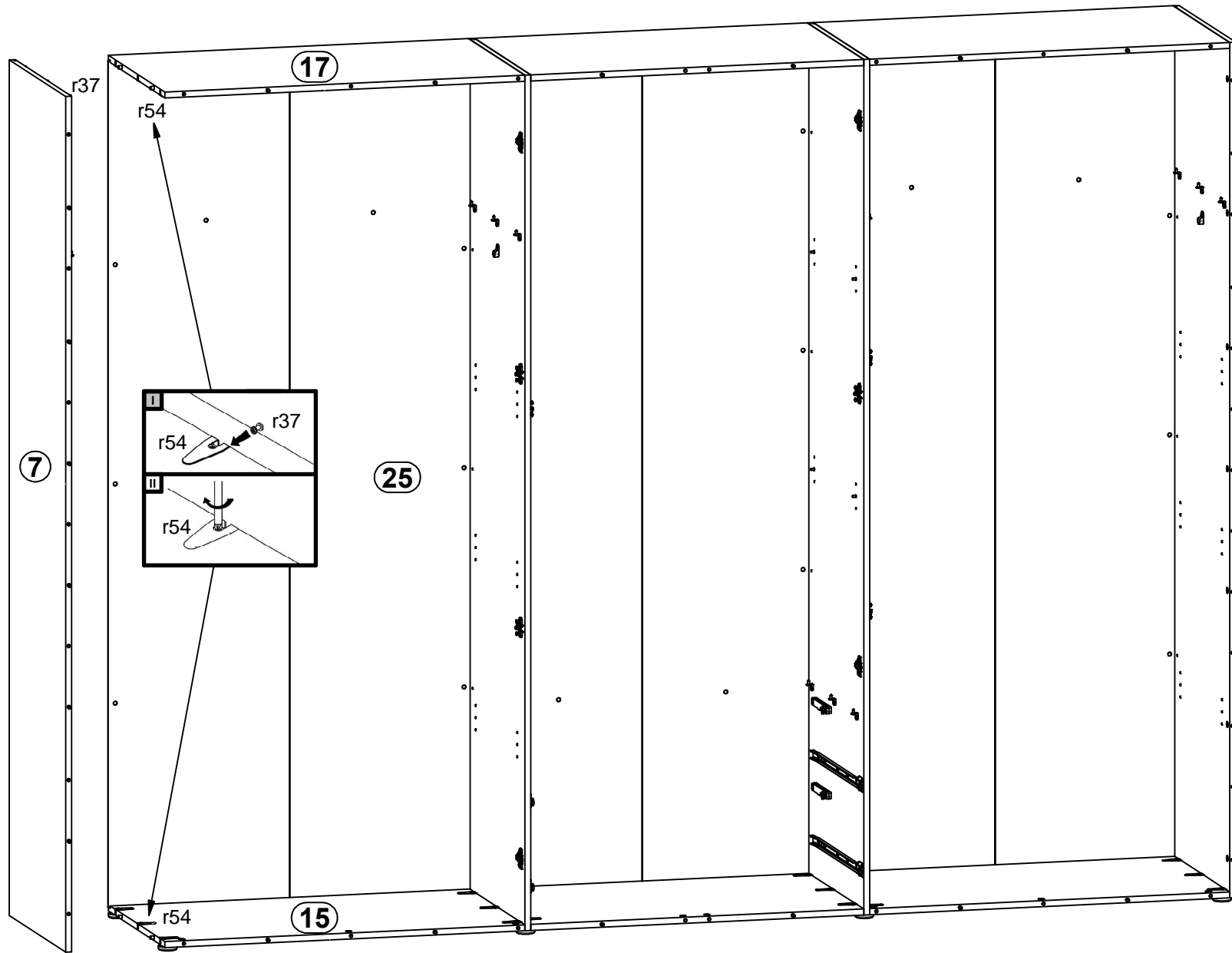

11

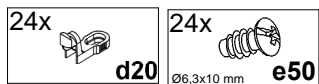
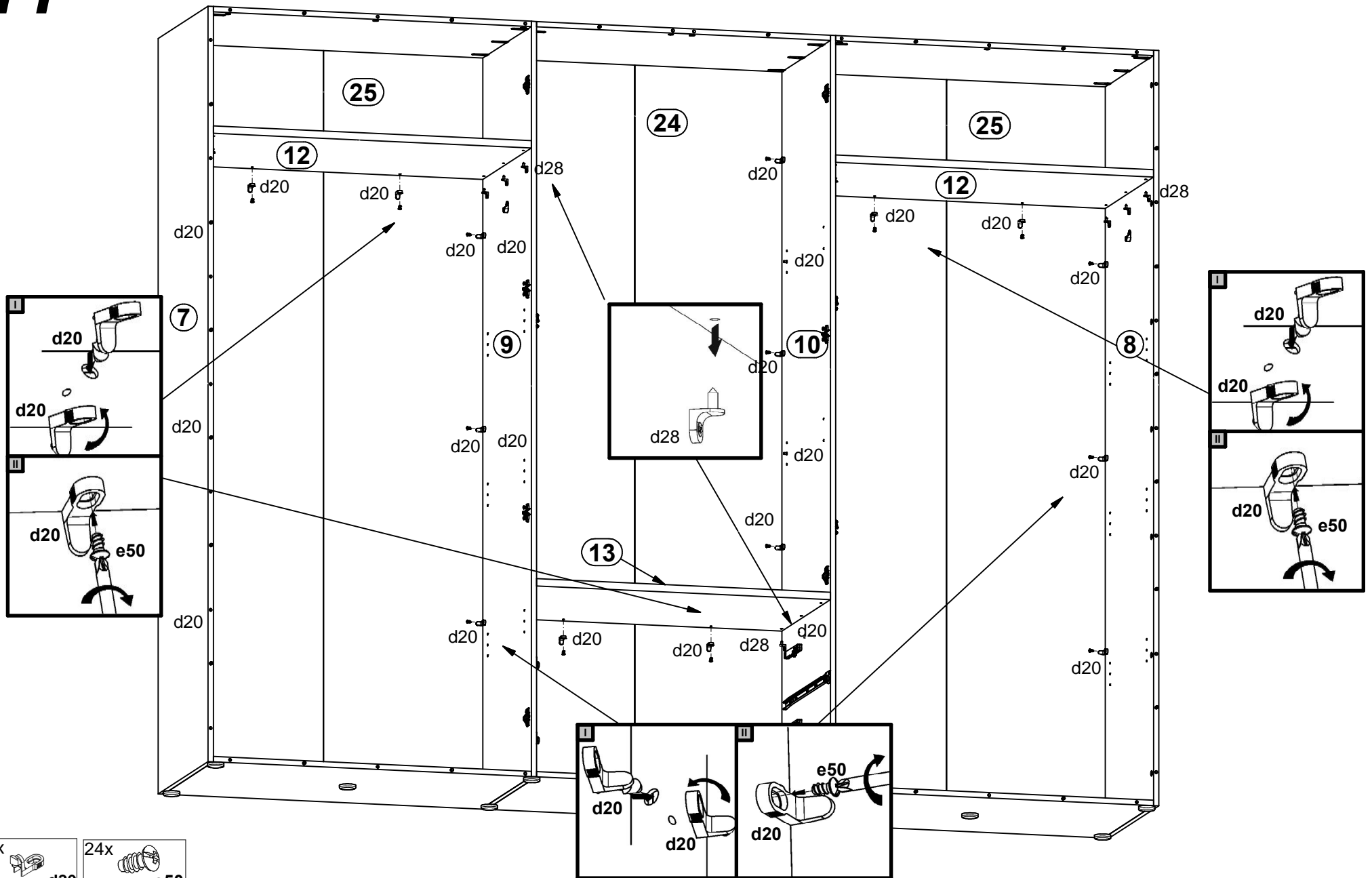

12

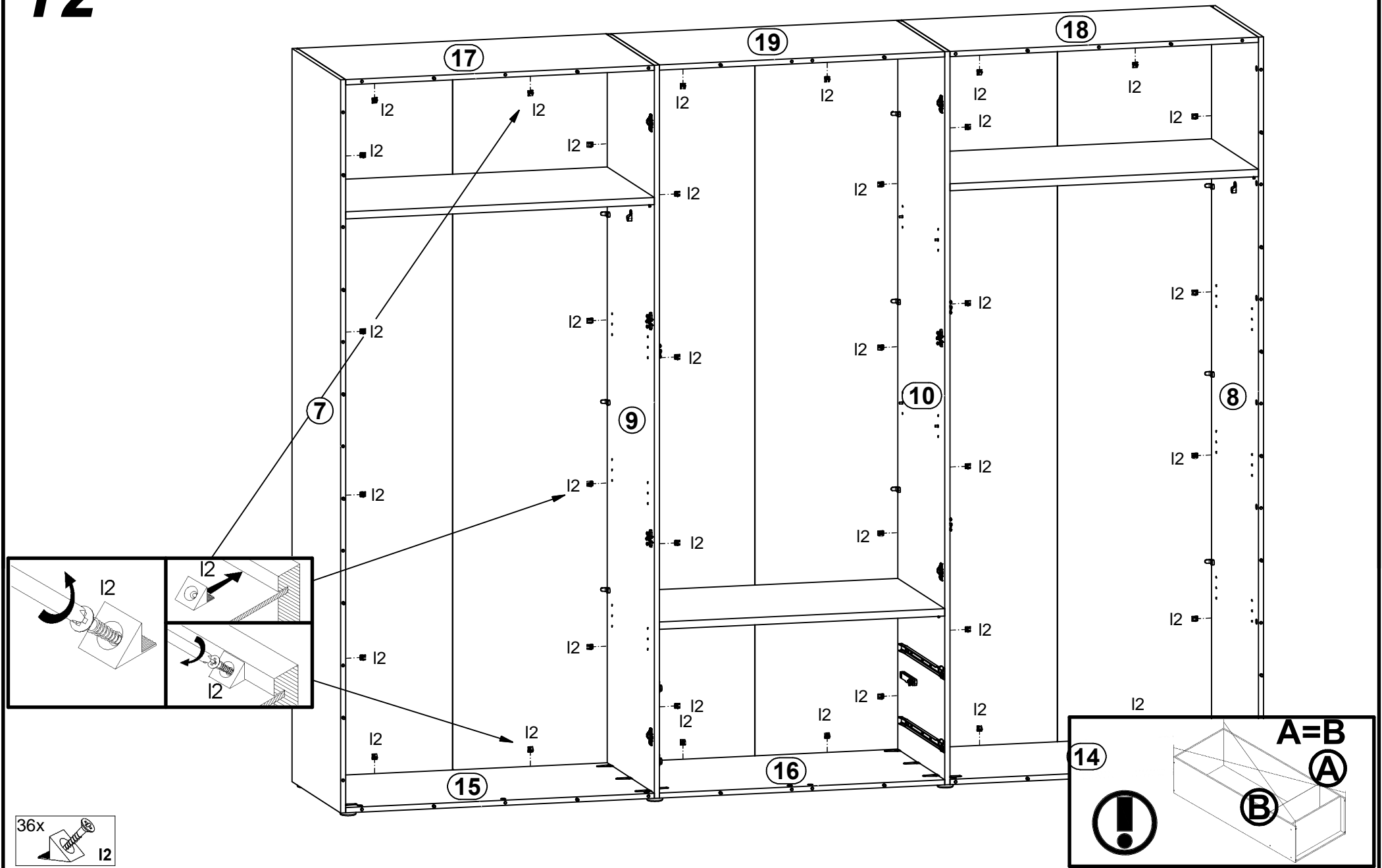

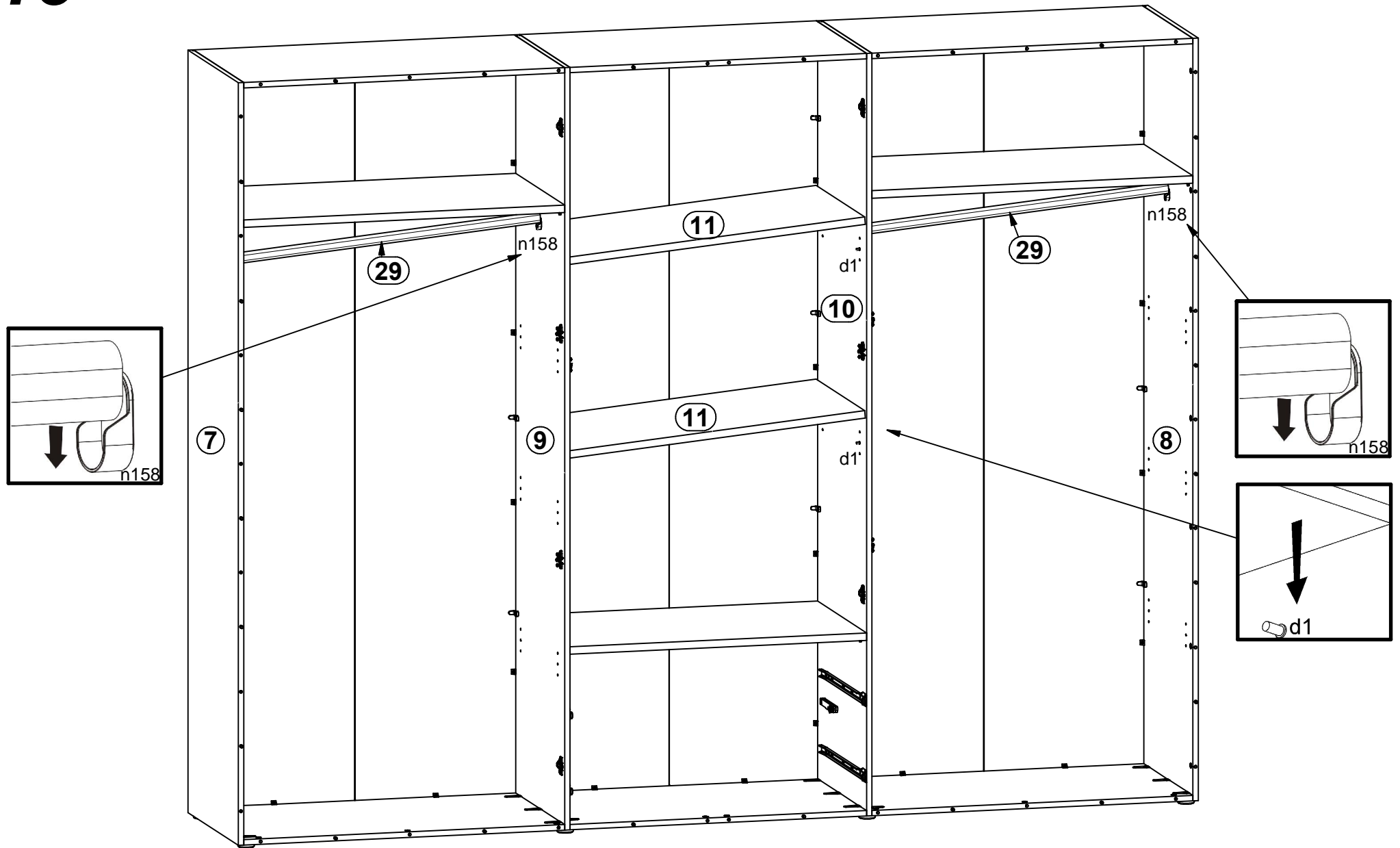

13

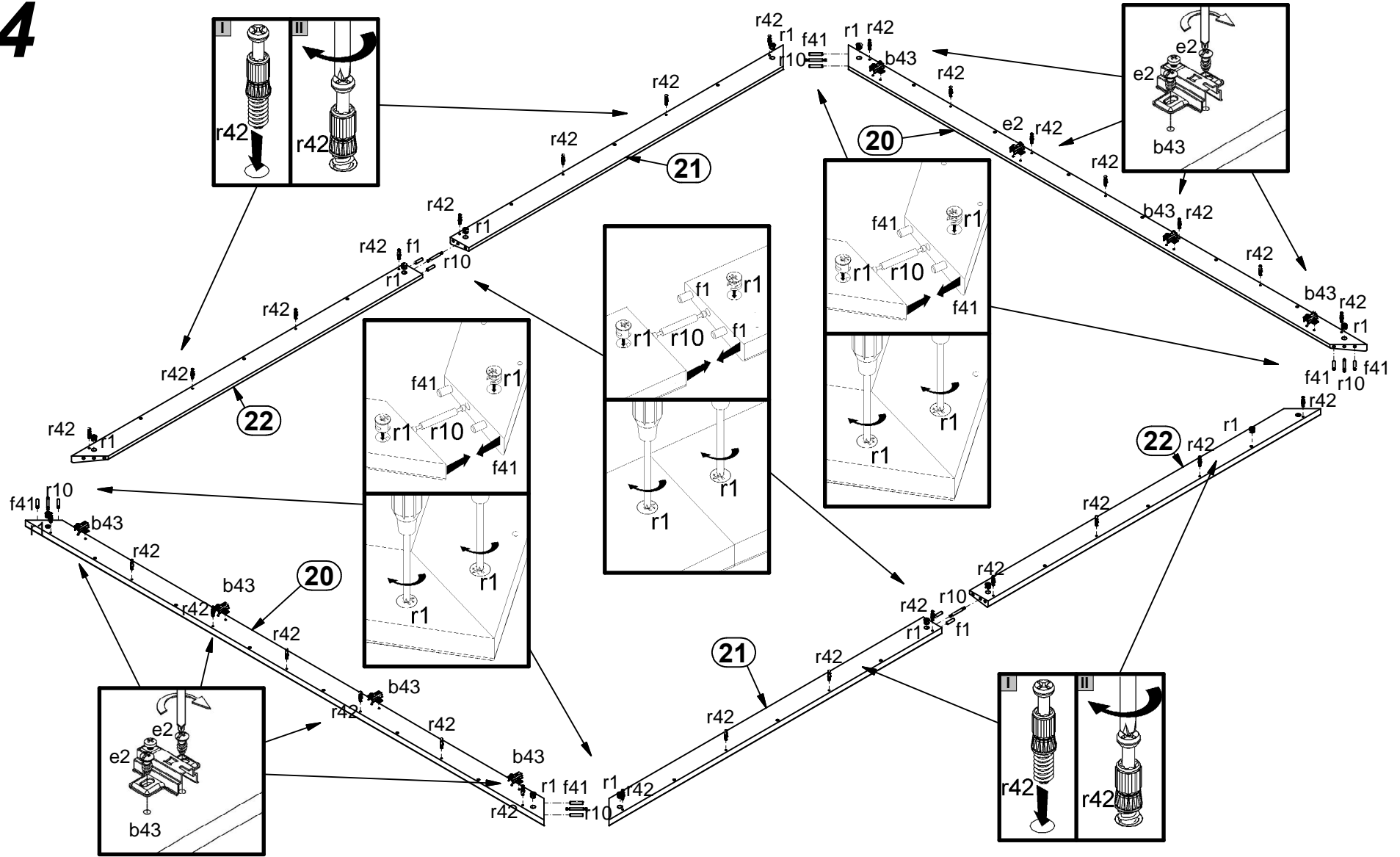

14

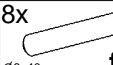
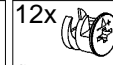
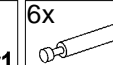
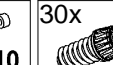
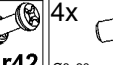

- 8x  **b43**
- 16x  **e2**
Ø6.3x13 mm
- 8x  **r42**
Ø8x40 mm
- 12x  **r1**
Ø15x12 mm #16
- 6x  **f1**
- 30x  **f41**
- 4x  **r10**
Ø8x30 mm

15

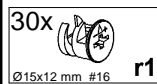
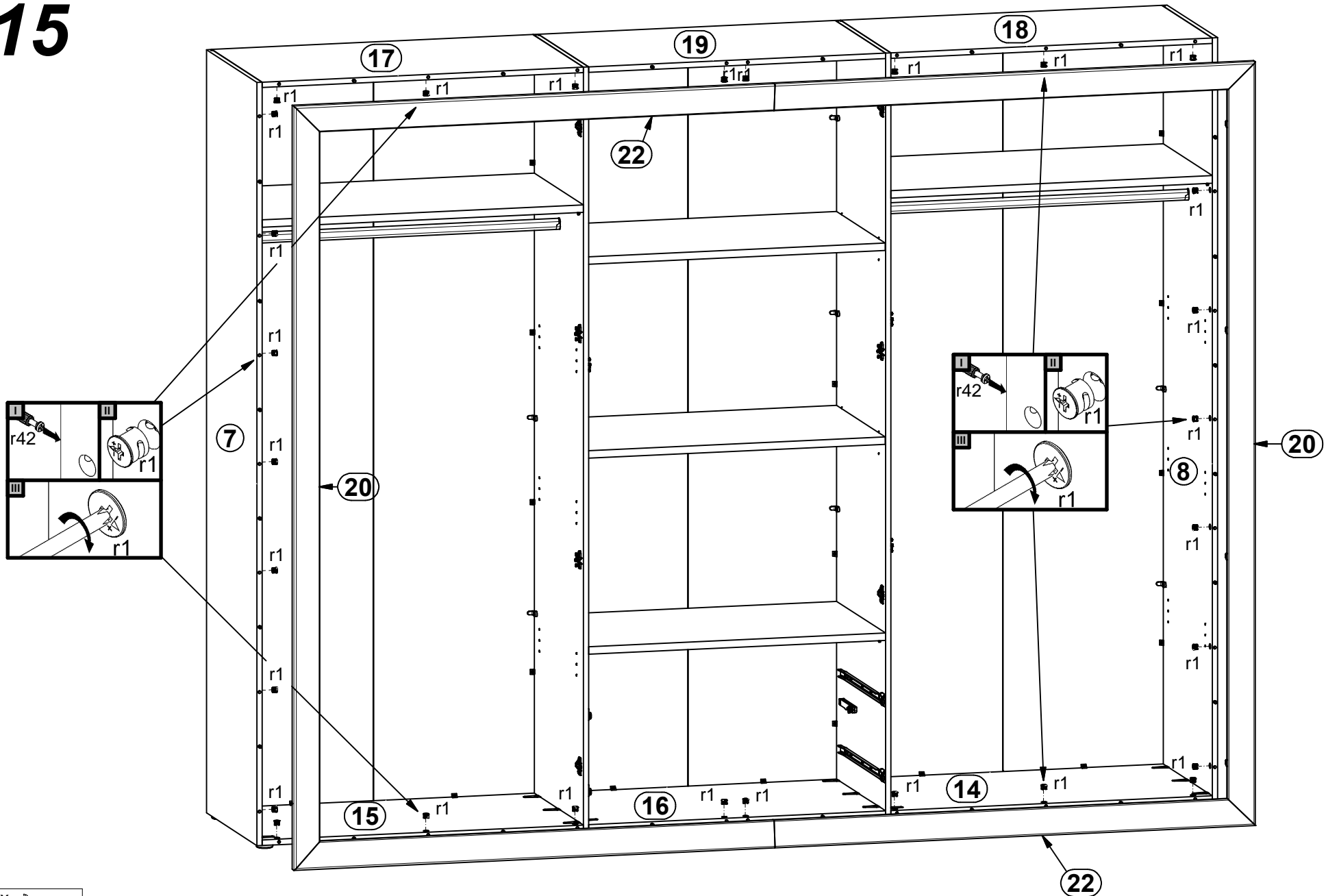

16

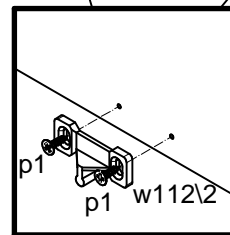
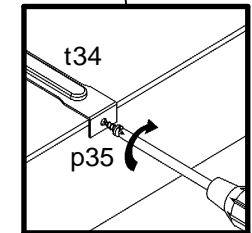
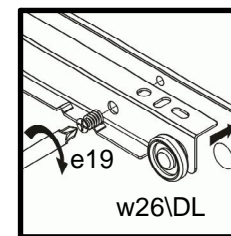
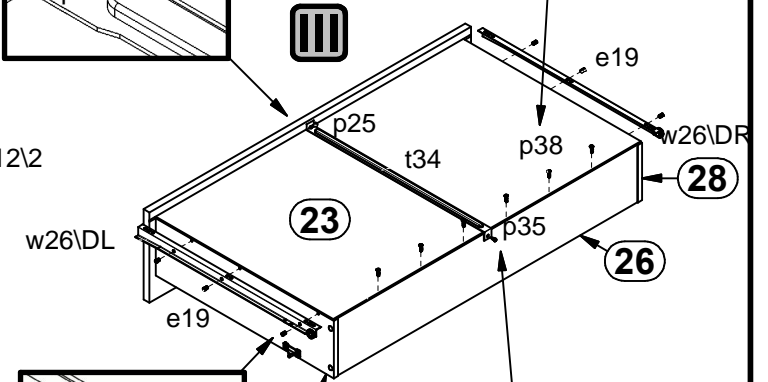
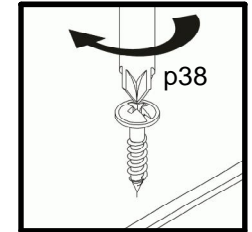
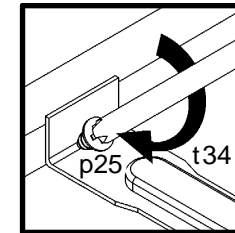
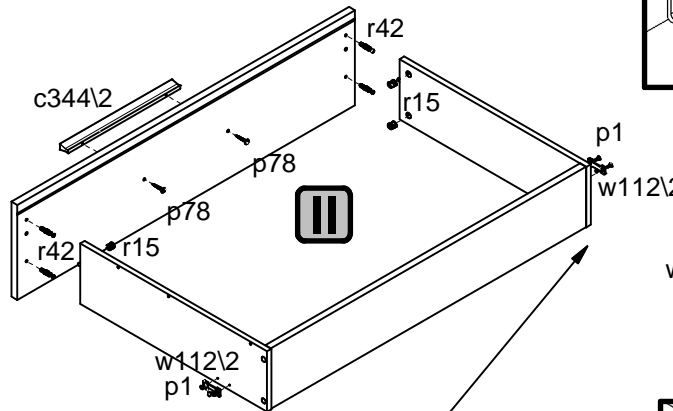
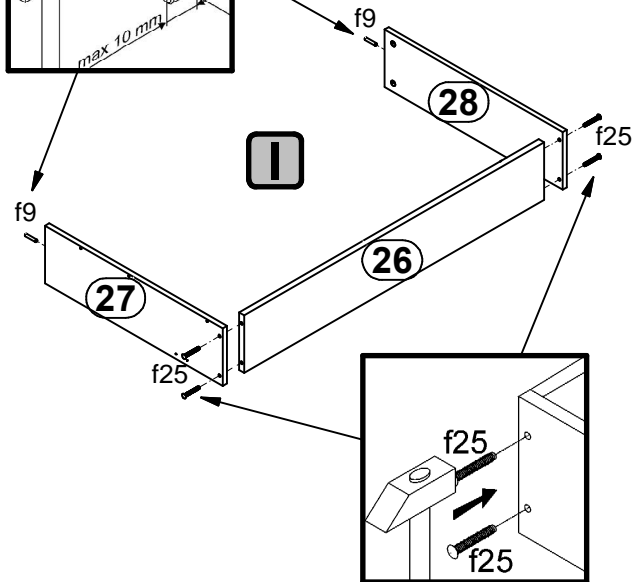
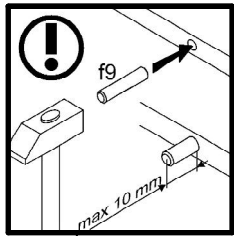
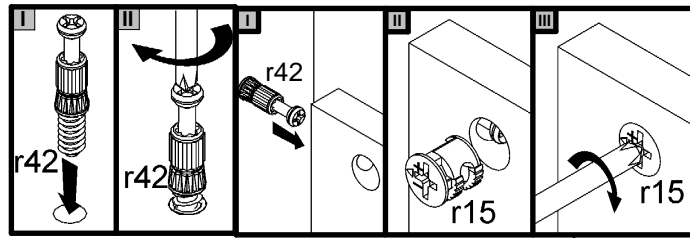

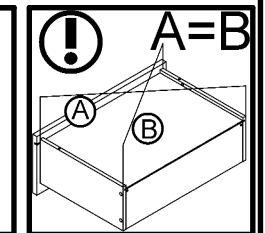
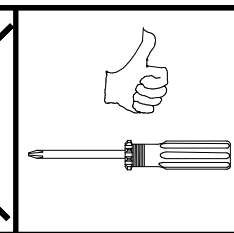
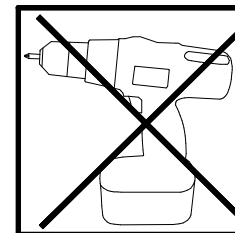

4x Ø3,5x13 mm p1	12x Ø5x9 mm e19	4x Ø6x30 mm f9	8x Ø6,5x40 mm f25	4x w112\2	2x Ø3,5x16 mm p25	2x Ø3,5x10 mm p35
12x Ø3,5x16 mm p38	4x Ø3,5x30 mm p78	8x Ø12x10,5 mm #12 r15	8x r42	2x 500 mm t34	2x 500 mm w26\DL	2x 500 mm w26\DR

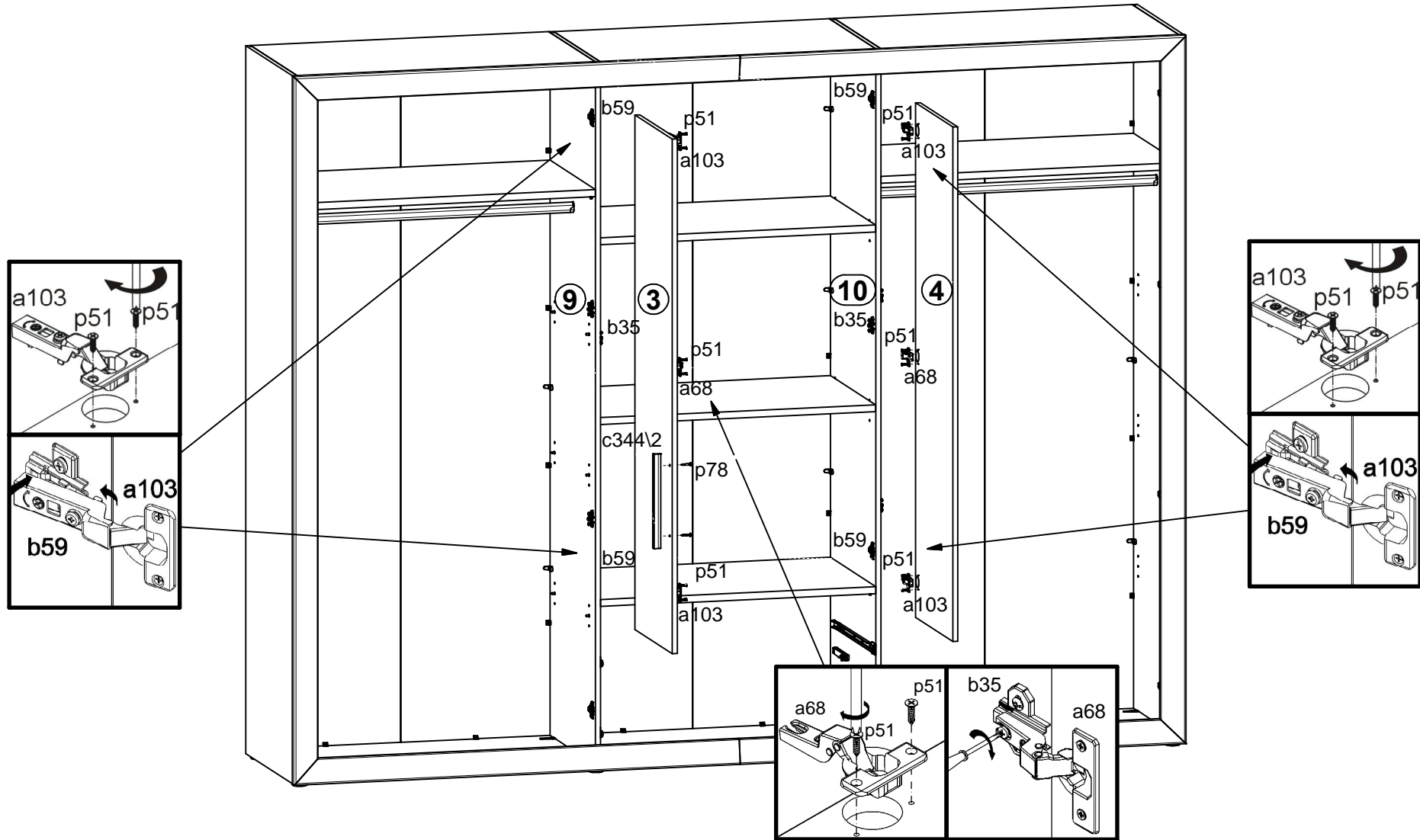

17

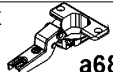

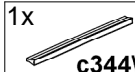
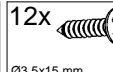
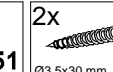
- 2x  **a68**
- 4x  **a103**
- 1x  **c344/2**
- 12x  **p51**
Ø3,5x15 mm
- 2x  **p78**
Ø3,5x30 mm

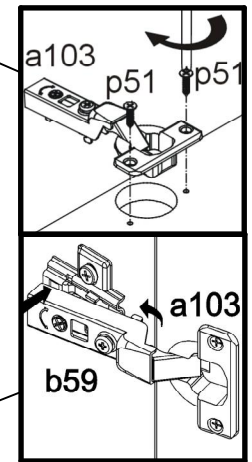
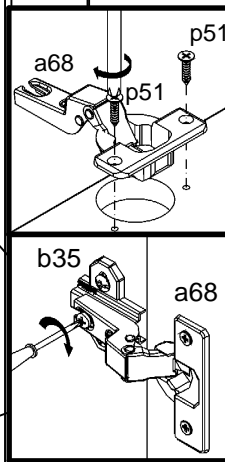
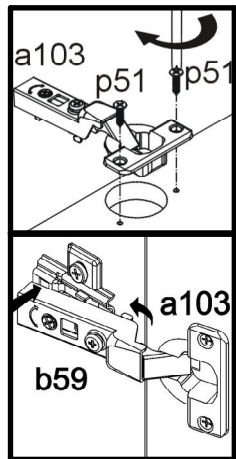
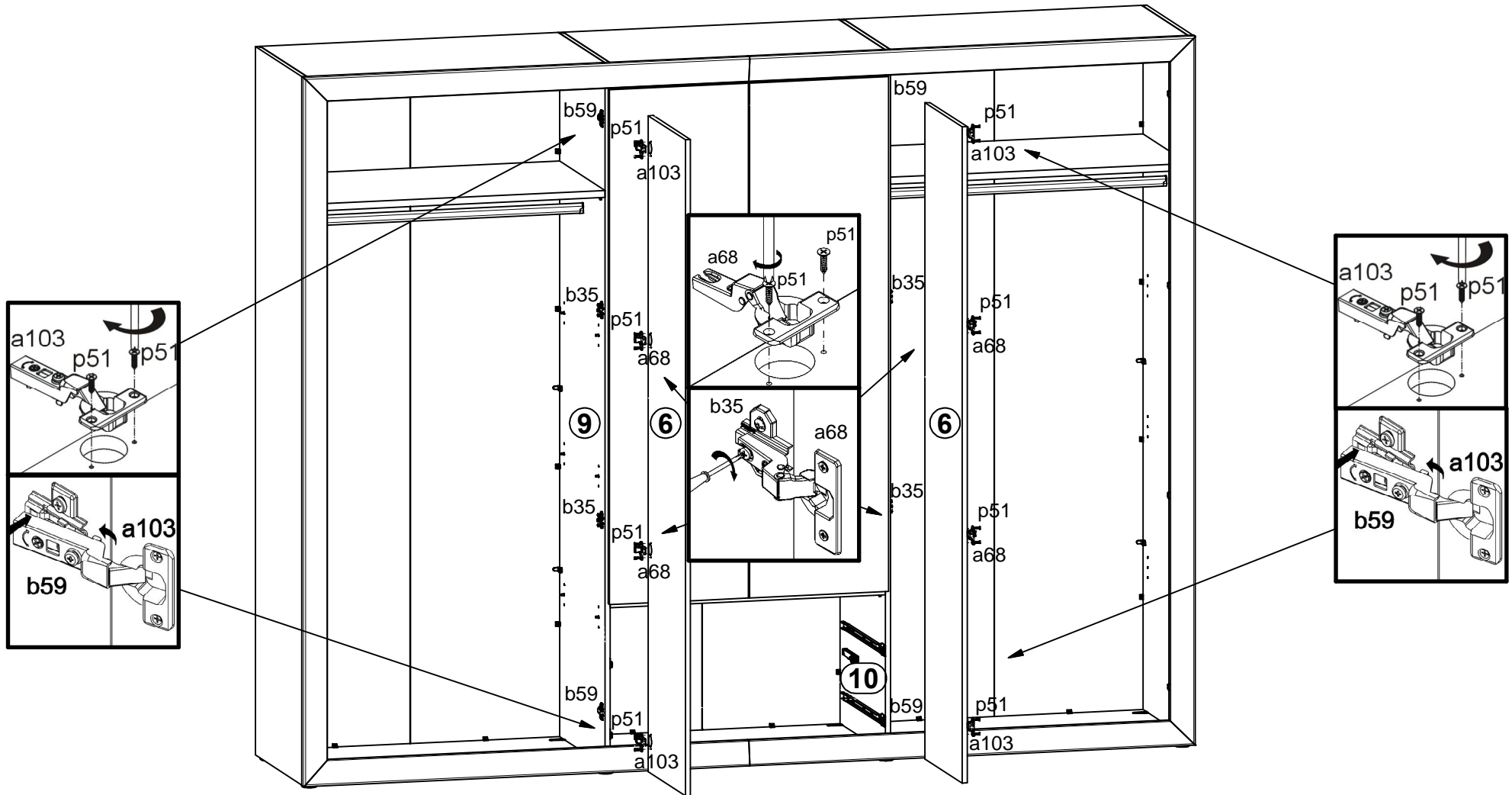

18

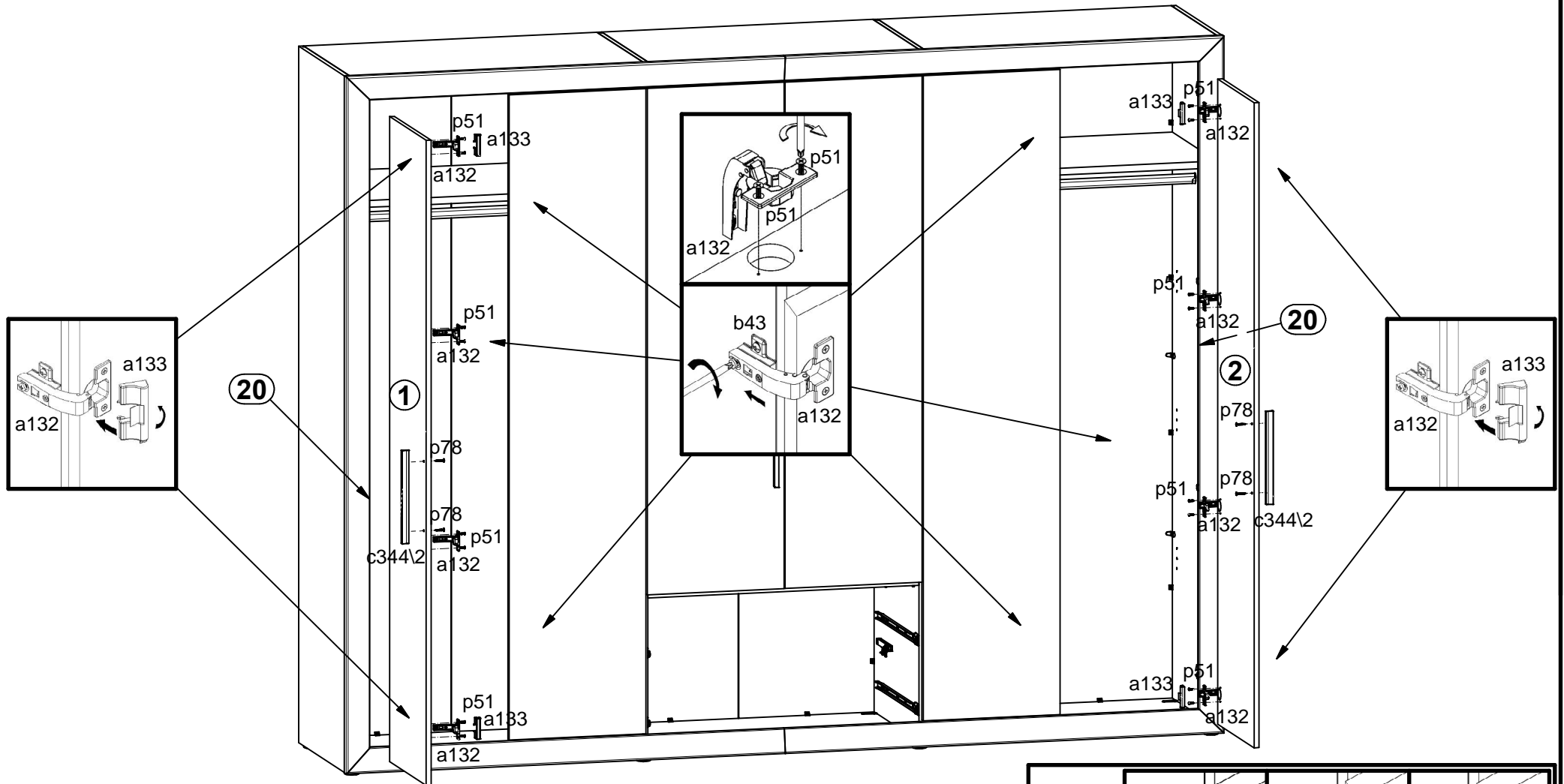

- 4x a68
- 4x a103
- 16x p51

19





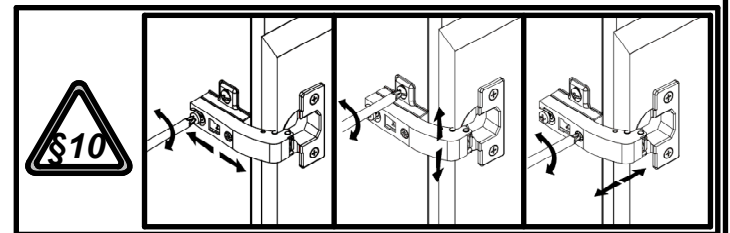

- 8x  a132
- 4x  a133
- 16x  p51
Ø3.5x15 mm

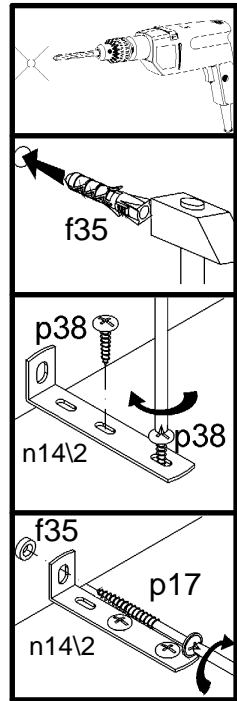
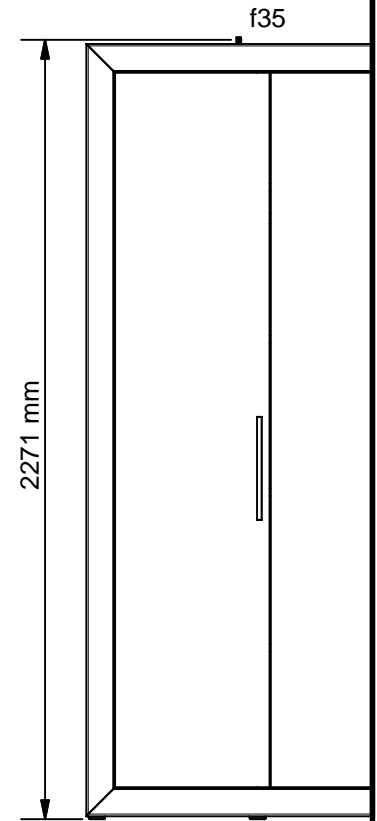
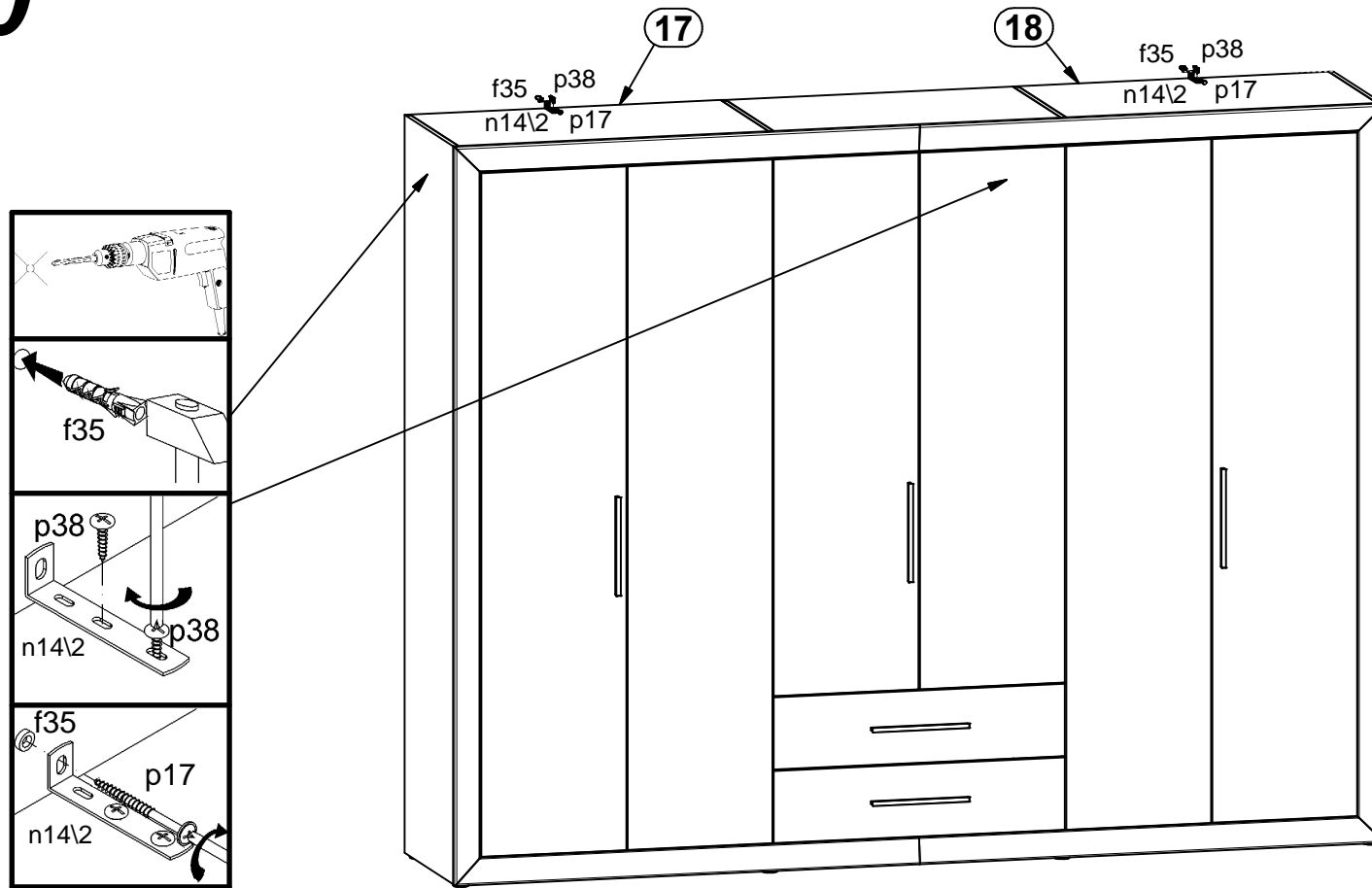

20

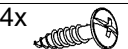

- 2x  f35
Ø10x50 mm
- 2x  p17
Ø5x60 mm
- 4x  p38
Ø3.5x16 mm
- 2x  n14/2
86x21x15/1.5

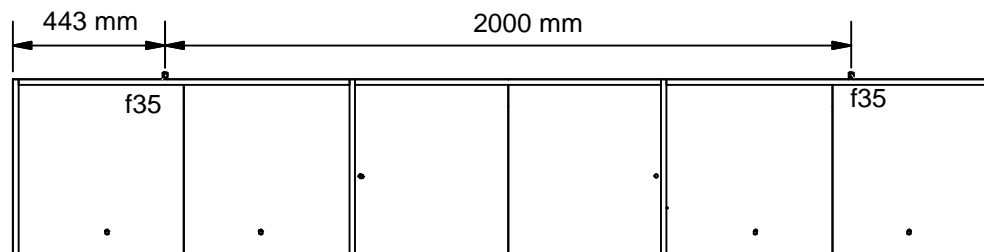

21

