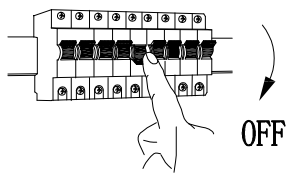
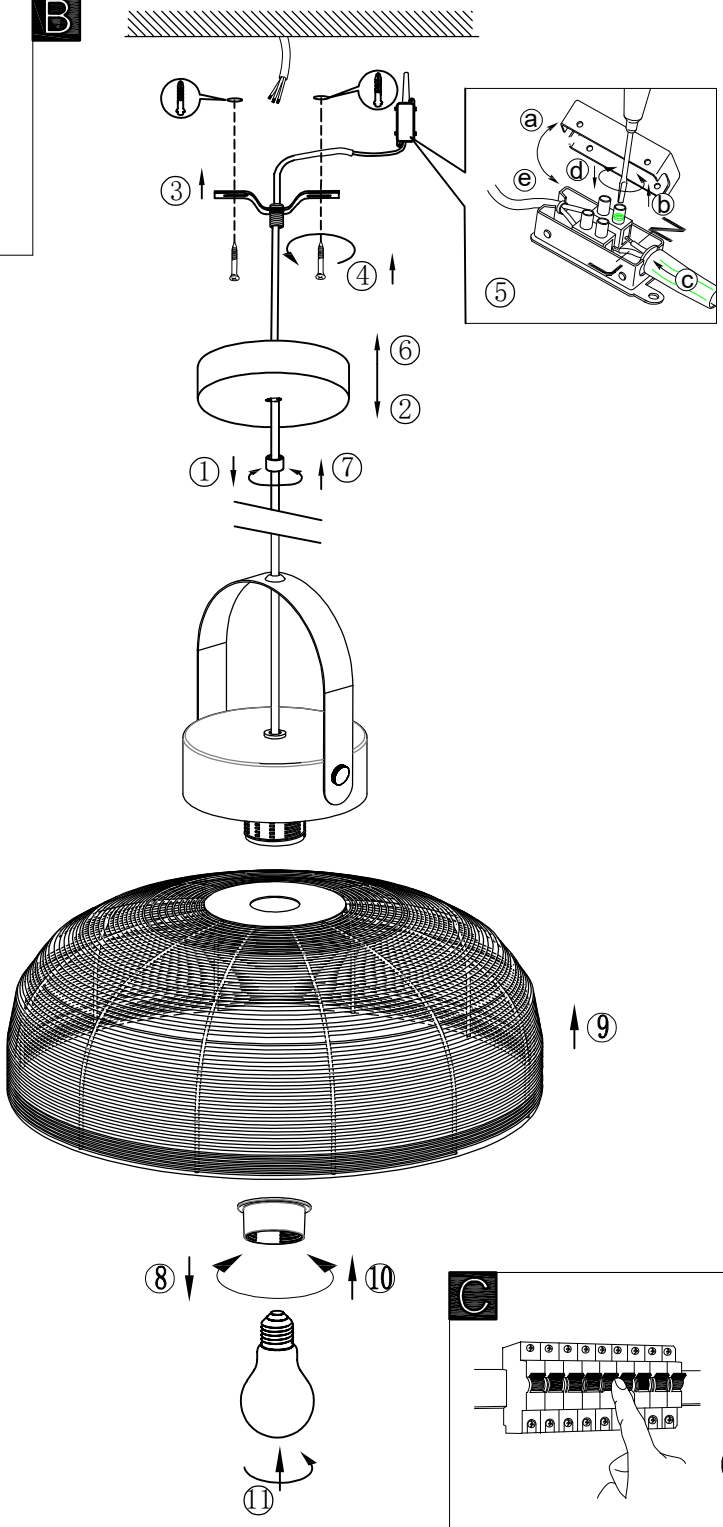
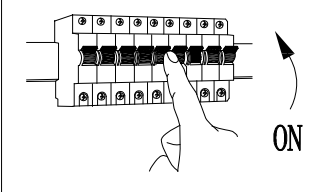

A**B****C**

B43964
www.eglo.com