

ø8 mm

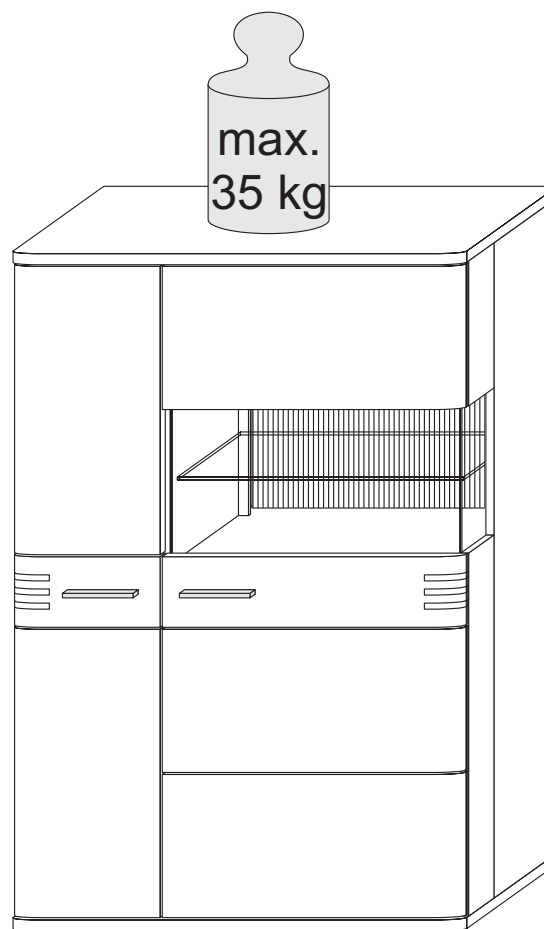

- (D) Montageanleitung
- (NL) Handleiding voor de montage
- (TR) Montaj talimatı
- (FR) Instructions de montage
- (CZ) Montážní návod
- (HU) Összeszerelési útmutató

- (GB) Assembly instructions
- (PL) Instrukcja montażu
- (RU) Инструкция по монтажу
- (IT) Istruzioni di montaggio
- (RO) Instrucțiuni de asamblare
- (SK) Montážny návod

# SALVADOR SAD52T20

2 / 6

1

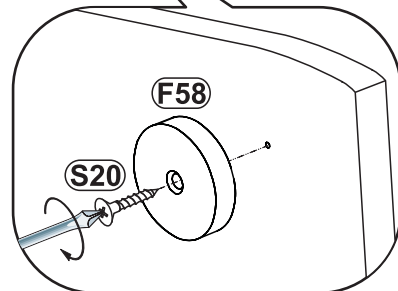
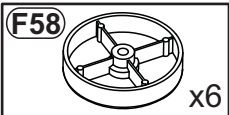
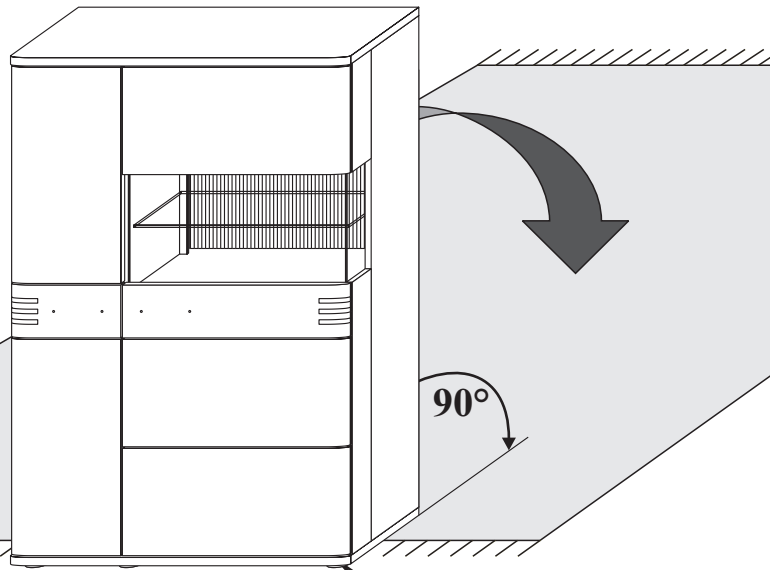
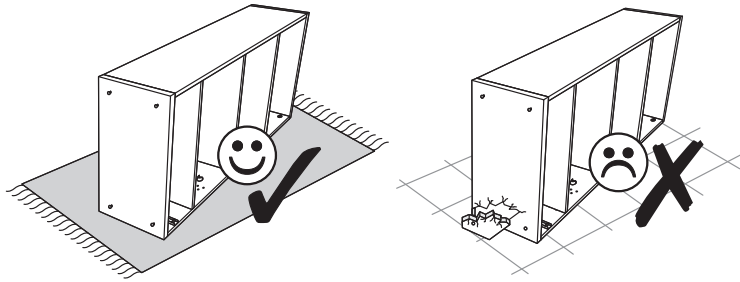

2

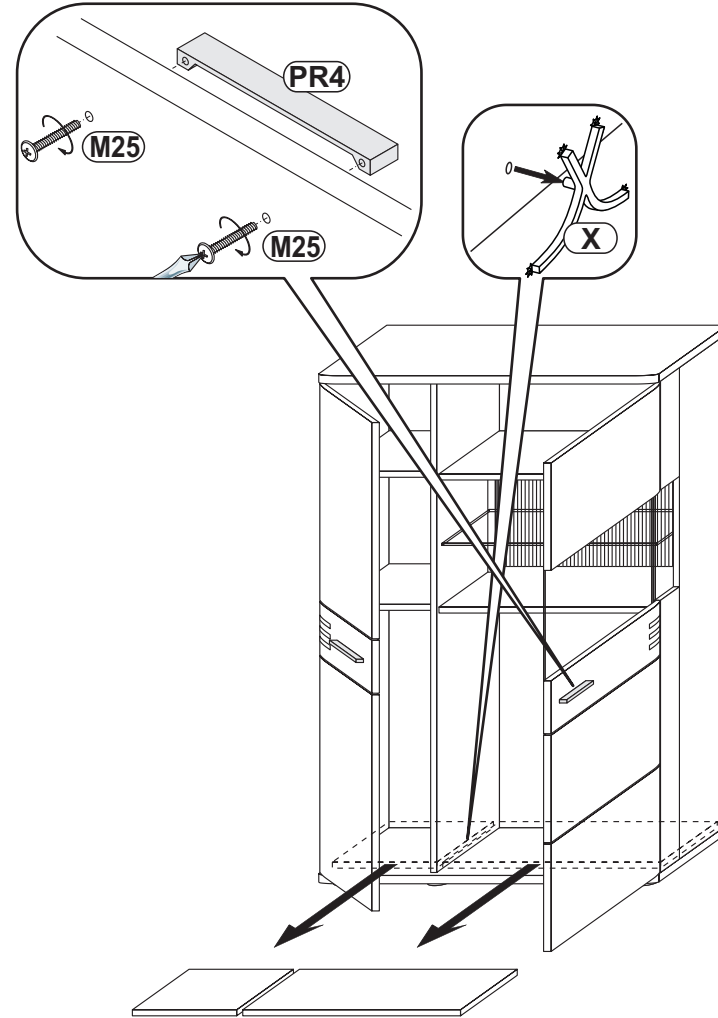
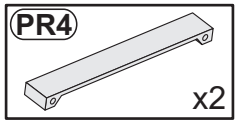

# SALVADOR SAD52T20

3 / 6

3

W1  x8

C3  x12

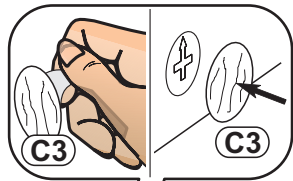

max.  
5 kg

max.  
10 kg

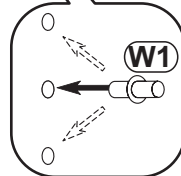
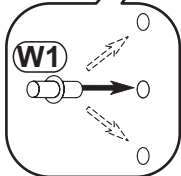
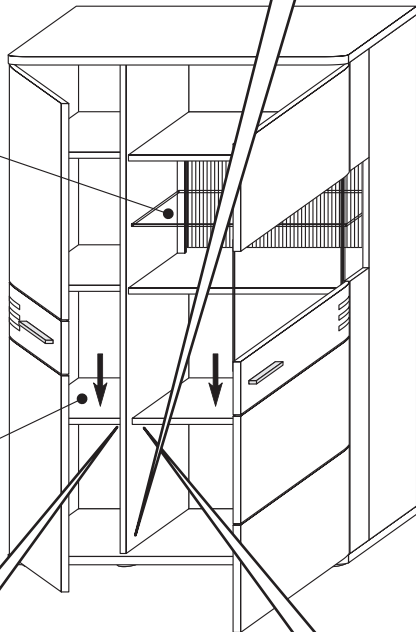

4

S4  3x16 mm x2

ZM1  x2

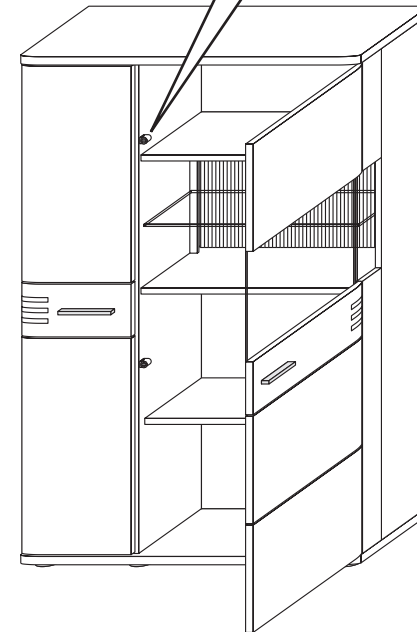
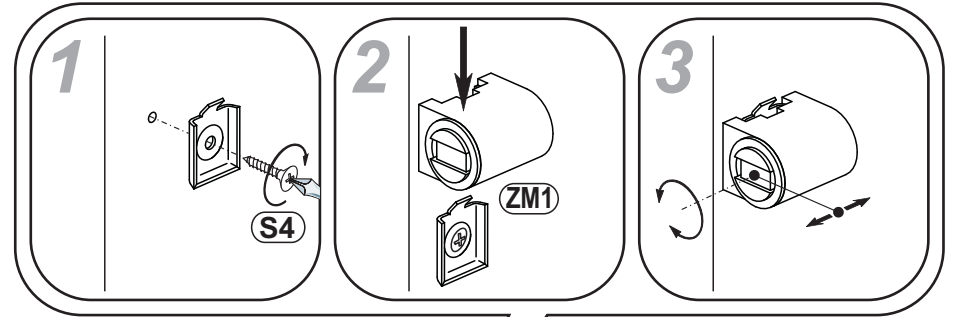

5

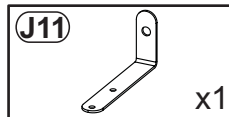
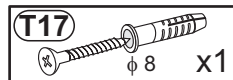
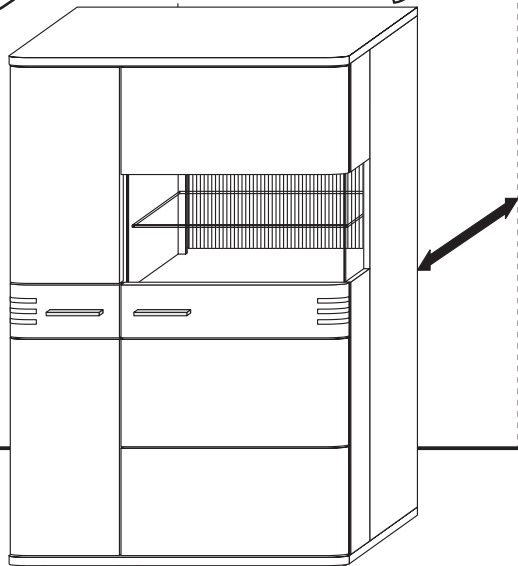
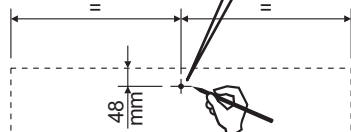
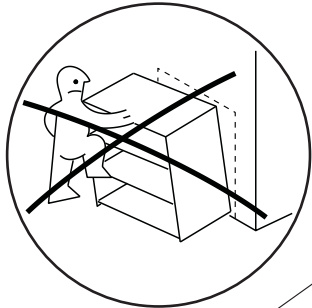
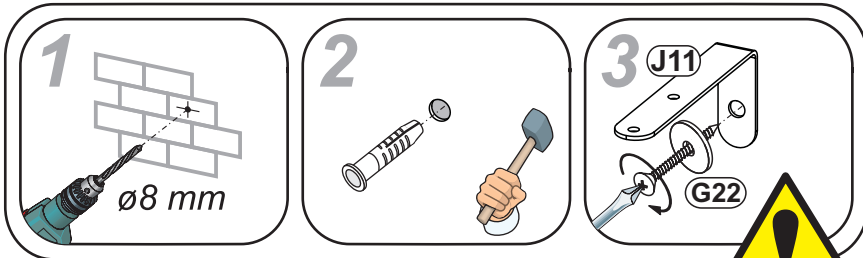

6

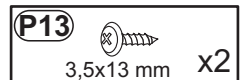
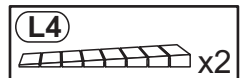
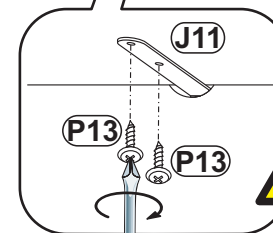
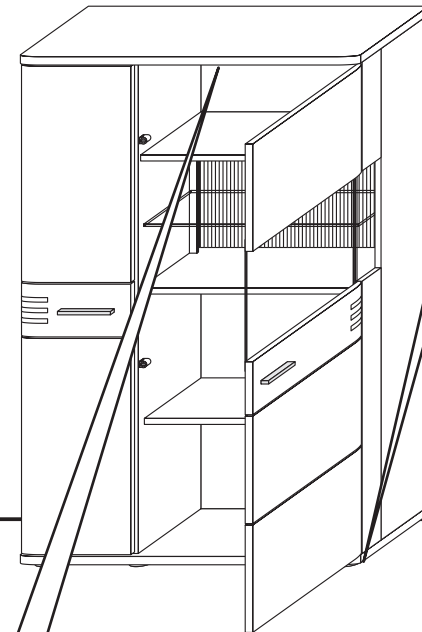
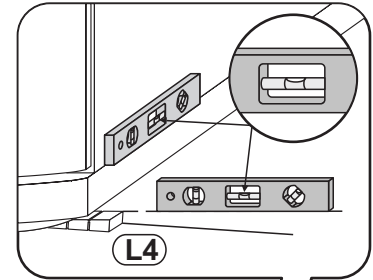

1

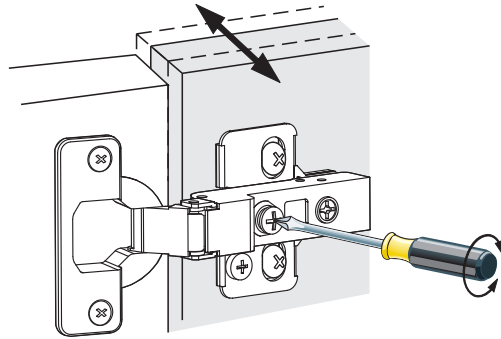
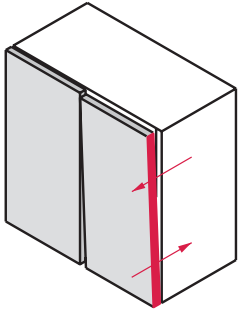

2

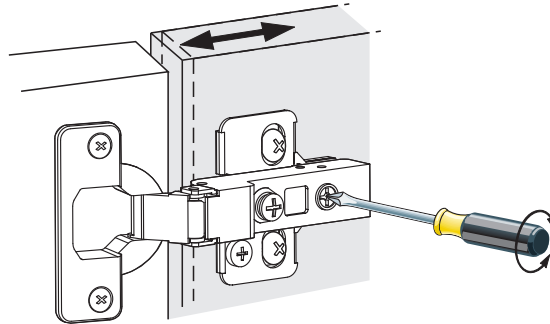
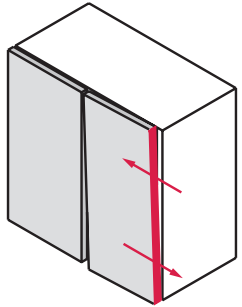

3

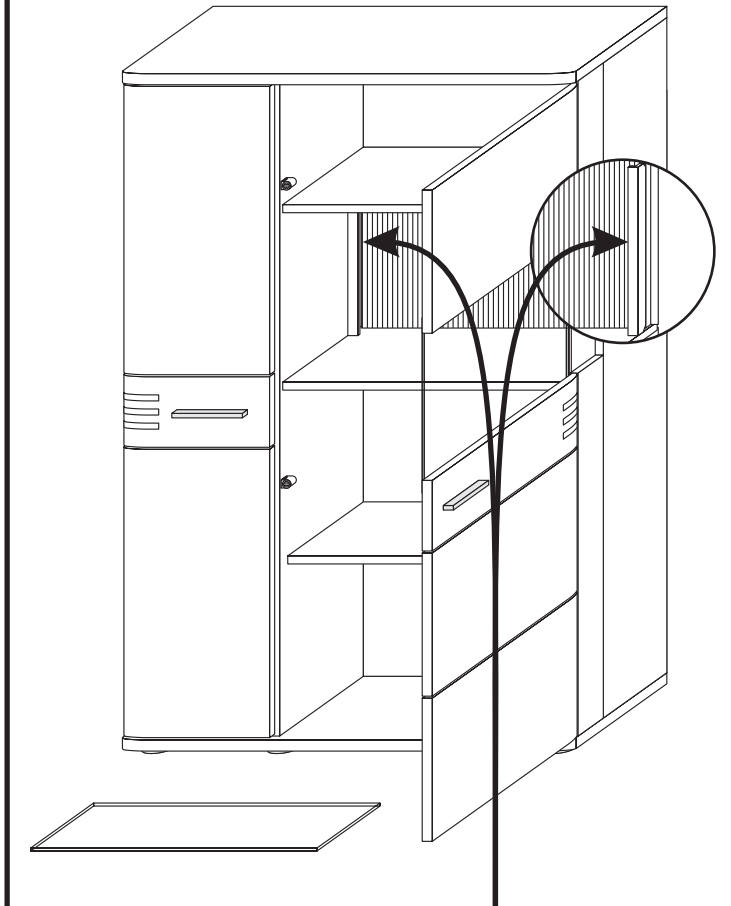
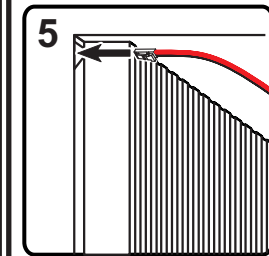
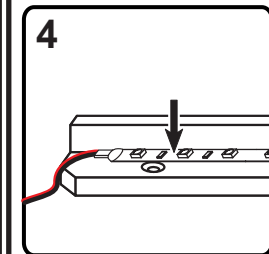
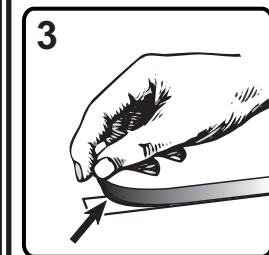
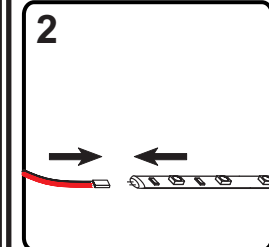
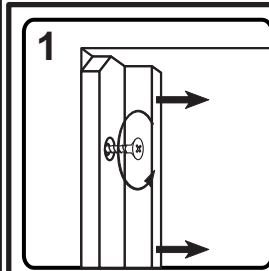
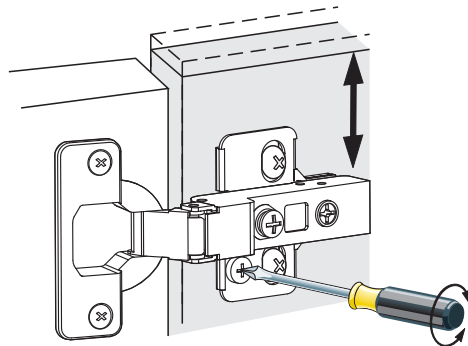
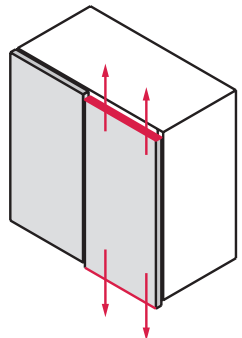

ZUBEHÖR BELEUCHTUNG 026031ZB

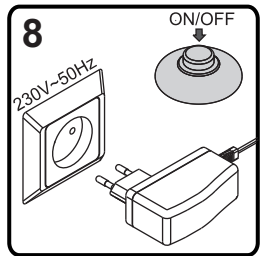
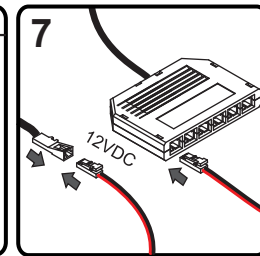
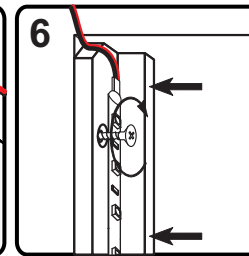

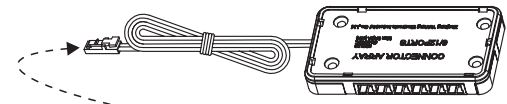
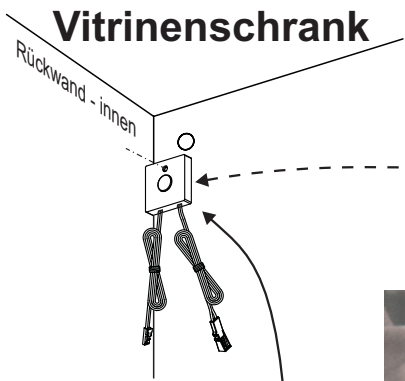
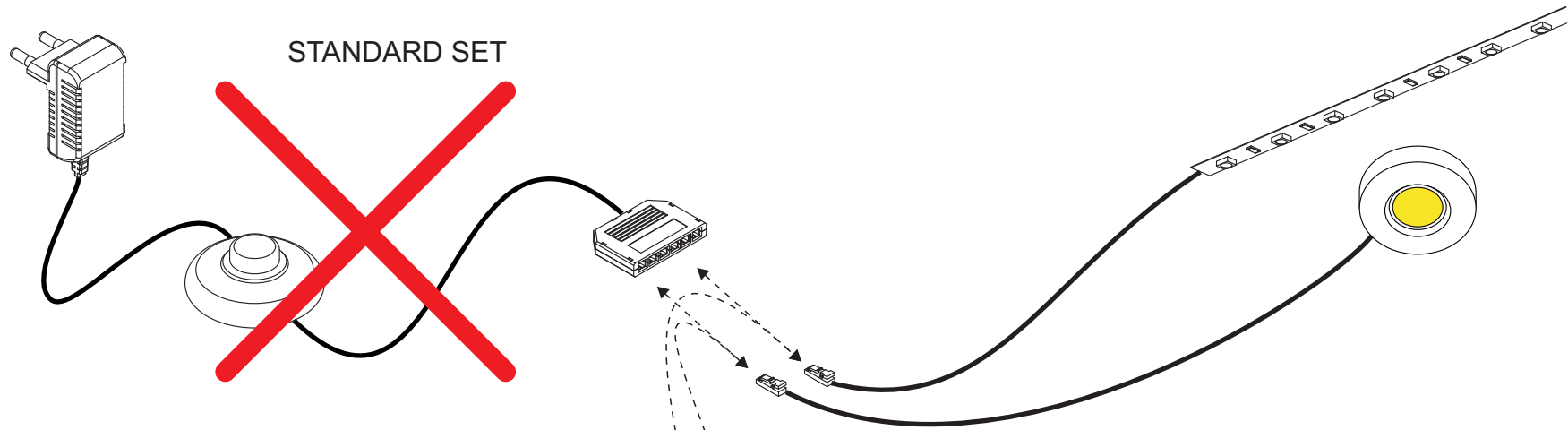

**ZUBEHÖR 006090ZB** Dimm & Touchschalter

