

Sehr geehrte Kundin,
sehr geehrter Kunde,

wir freuen uns, dass Sie sich für ein Badmöbel aus unserem Hause entschieden haben.
Unsere Möbel zeichnen sich durch höchste Qualitätsansprüche mit zuverlässiger Funktionalität "Made in Germany" aus.

Sollte es trotz unserer intensiven Qualitätskontrollen zu Fehlteilen oder Beschädigungen gekommen sein, nutzen Sie bitte für die schnelle Nachbestellung von Kleinteilen unseren 24/7 Online-Service unter www.pelipal.de/service/ersatzteilbestellung/



Für eine zuverlässige Bearbeitung benötigen wir von Ihnen dazu:

1. **Die Artikelnummer des Schrankes** (xxx.xxxxxx), die Sie auf der Bauanleitung oder dem jeweiligen Etikett finden
2. **Die Angabe unseres Vertriebspartners**, über den Sie die Möbel erworben haben
3. **Die benötigte Stückzahl** des entsprechenden Bauteils. Bitte nutzen Sie dafür die 2. Seite der Montageanleitung mit der Stückliste.

Bitte beachten Sie, dass Sie größere Bauteile ab einer Länge von 80cm, bzw. ab einer Breite von 30cm aus logistischen Gründen direkt über unseren Vertriebspartner anfordern, bei dem Sie die Möbel erworben haben!

Ihre Zufriedenheit ist uns sehr wichtig!

Daher garantieren wir Ihnen über diesen Weg die schnelle Abwicklung Ihres Anliegens und wünschen Ihnen weiterhin viele Freude mit Ihren neuen Badmöbeln.

Ihr Pelipal-Team



Für den Zusammenbau sind 2 Personen erforderlich.



Montage-Richtzeit 3 Stunden

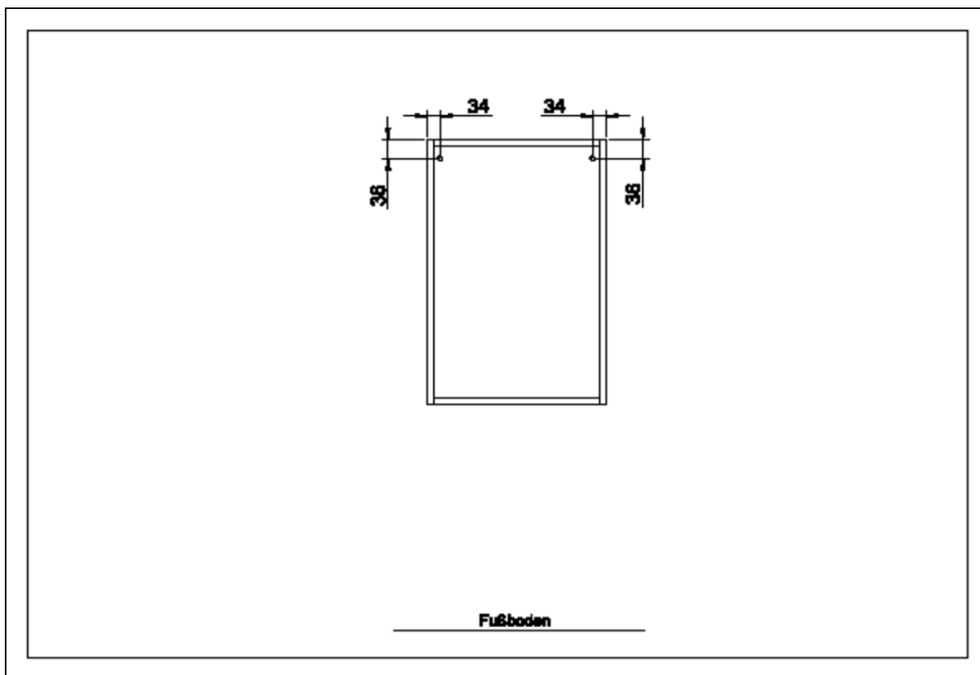

Artikel-Nr.: 917.013030

	Bauteil	Ist Menge	Benötigte Menge
A+B	S-917-013030--	2	
C	K-917-013030--	2	
D	T-917-013030--	1	
E	RWD-WE1-Z00003	1	
F	GBO-005-0267X0150	2	

a	DUEB-SMD-000005	8	
b	EXZENTER-000015	8	
c	ZPL-003X004	2	
d	TBD-35-115X00	2	
e	AUF-001-000020	2	
f	TRAE-001-000020	8	
g	AUF-001-000060	2	
h	GRI-160-316010	1	
j	SCH-KNO-M04X024	2	
k	SCH-SPA-035X015	6	
l	NAGEL-025X001	10	
m	SCH-SPA-035X025	4	
n	ADK-WE1-005X008	2	
o	TUER-DAEM-000010	1	
p	TUER-ADA-000010	1	
r	VBD-000020	1	
s	SCH-RDK-045X045	1	
t	SCH-RDK-040X015	1	
u	ADK-AL1-005X008	2	

330/925

318/359/917/919

MOT-013030-002S1

Datum 26/11/20 A4

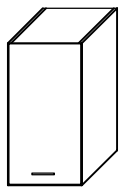
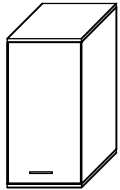

3__-0_3030
9__-013030

8 x a

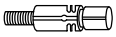

DUEB-SMD-000005

8 x b



EXZENTER-000015

2 x c



ZPL-003X004

2 x d

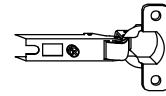

TBD-35-115X00

2 x e

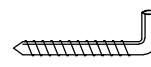

AUF-001-000020

8 x f



TRAE-001-000020

2 x g

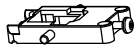

AUF-001-000060

1 x h



GRIFF

2 x j



SCH-KNO-M04

6 x k



SCH-SPA-035X015

10 x l



NAGEL-025X001

4 x m

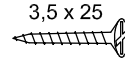

SCH-SPA-035X025

2 x n



ADK-__1-005X008

1 x o

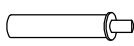

TUER-DAEM-000010

1 x p

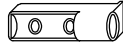

TUER-ADA-000010

1 x r

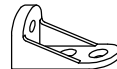

VBD-000020

1 x s

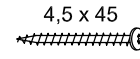

SCH-RDK-045X045

1 x t

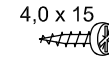

SCH-RDK-040X015

2 x u



ADK-AL1-005X008

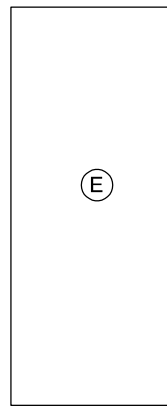
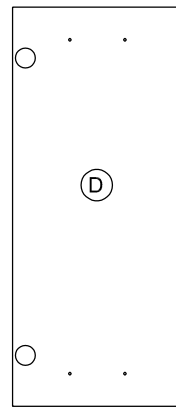
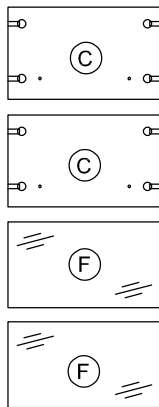
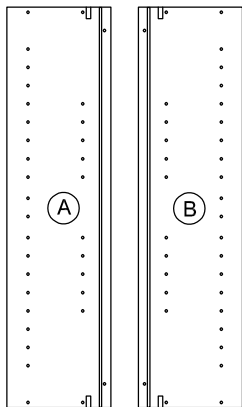

330-013030



925-013030



4 x v

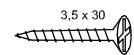

SCH-SPA-035X030

4 x w

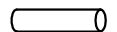

TRAE-005-000010

1.

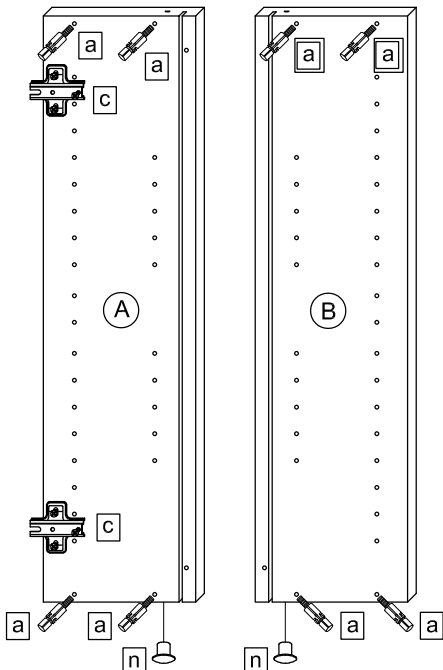
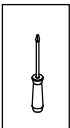

318
359
917
919

1.

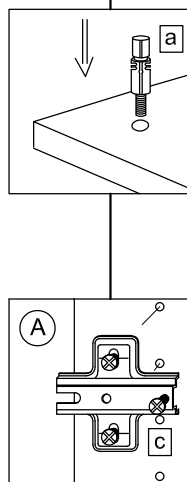
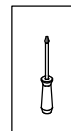

330
925

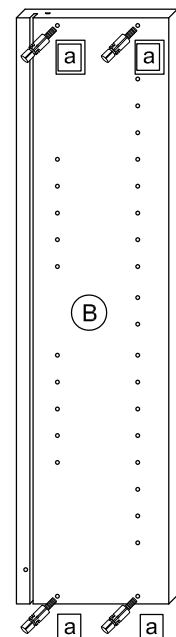
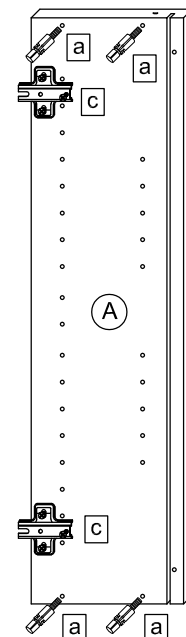

2. 318
 359
 917
 919

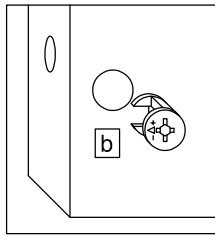
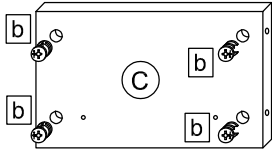

2. 330
 925

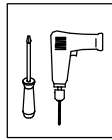

2.1

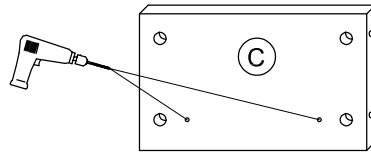
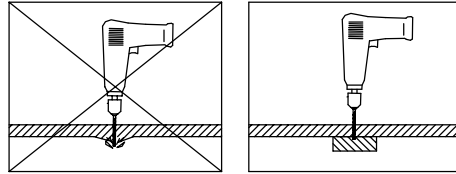

2.2

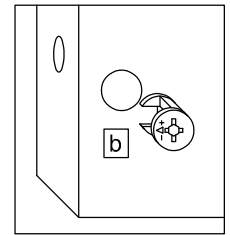
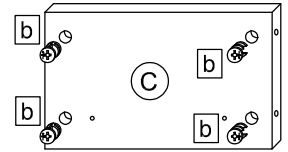

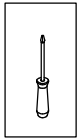
3. 

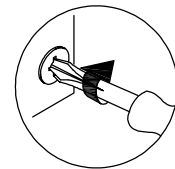
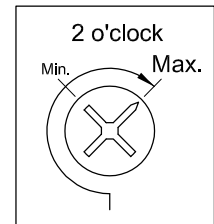
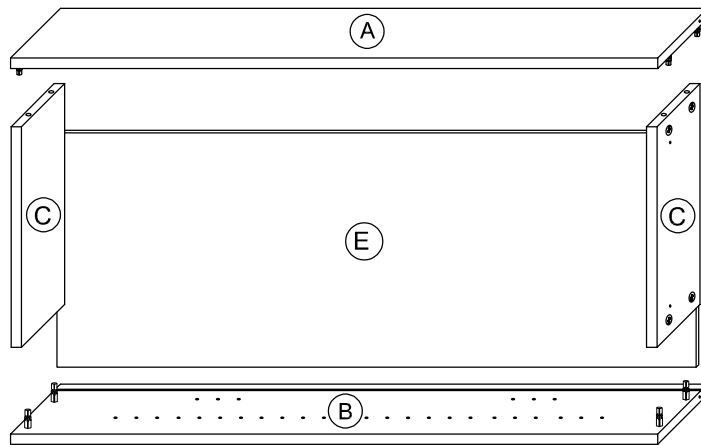

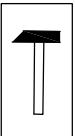
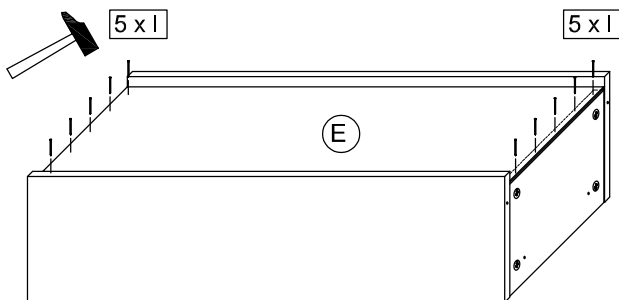
4.   5 x l

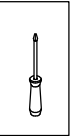
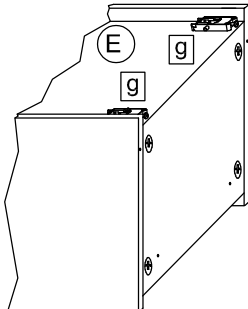
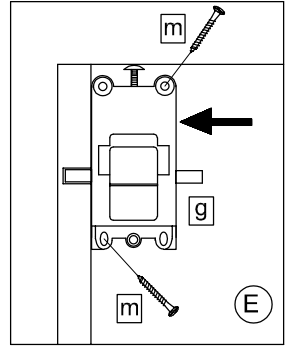
5.    E

6.

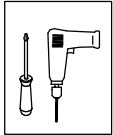

6.1

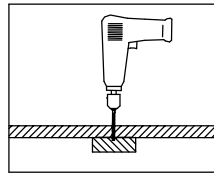
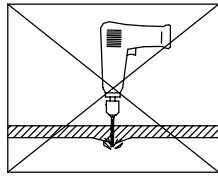

330
925

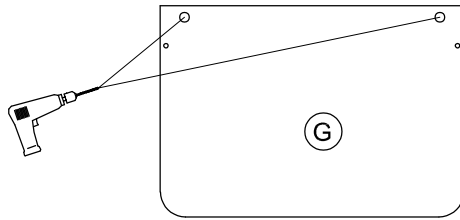

6.2

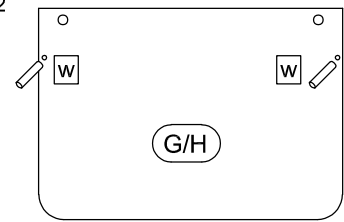

7.

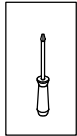

330
925

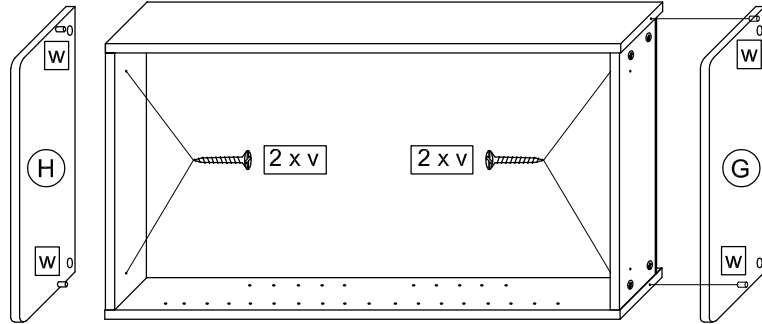

8.

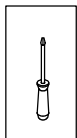

T9 Lassen Sie den Schrank nur durch fachkundige Personen mit für die Wand geeignetem Montagematerialien montieren.

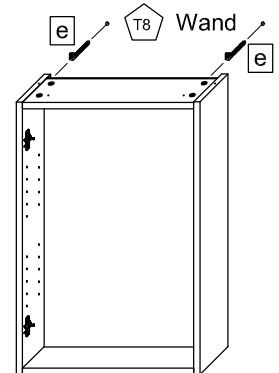
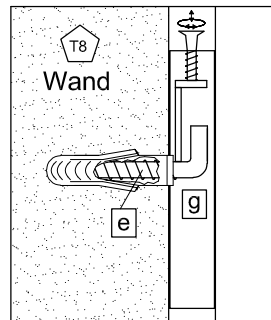

9.

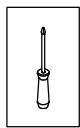

318
359
917
919

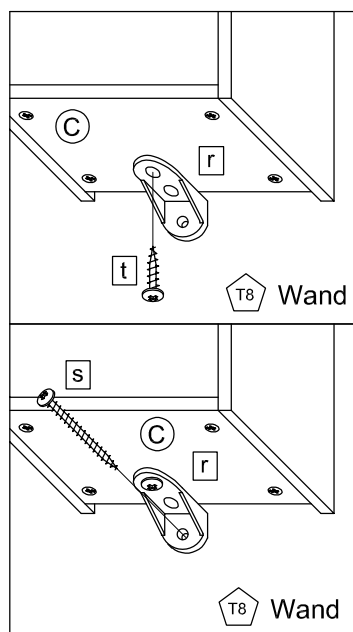

9.

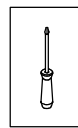

330
925

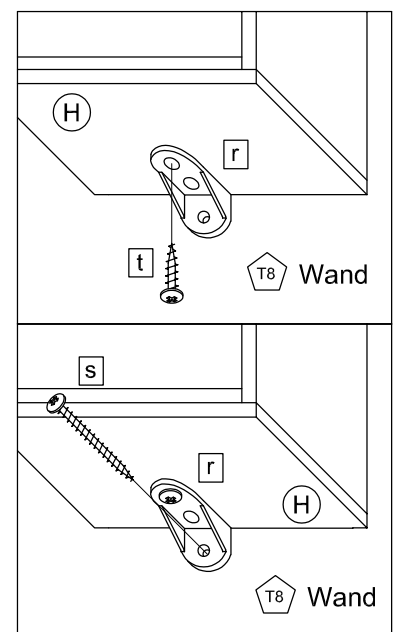

10.

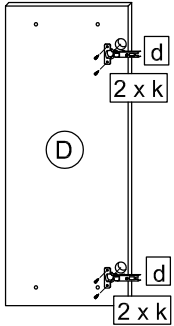
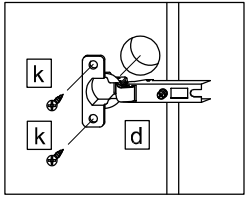
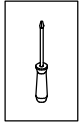

11.

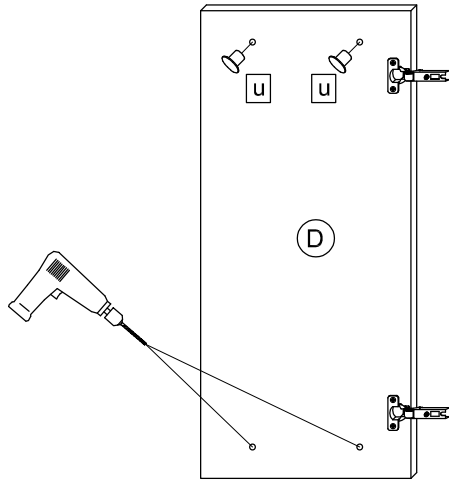
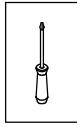

11.1

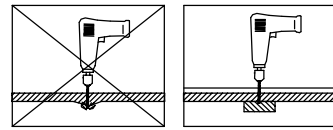

11.2

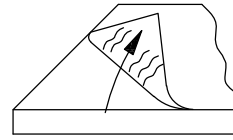

Bei Hochglanz-Fronten bitte erst die Schutzfolie entfernen und dann den Griff montieren!

11.3

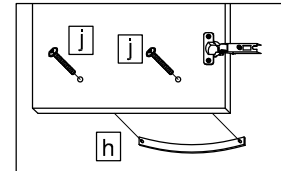

12.

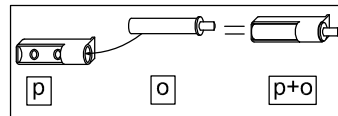
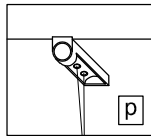
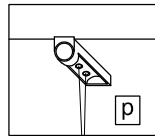
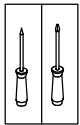

2 x k
(3,5x15)

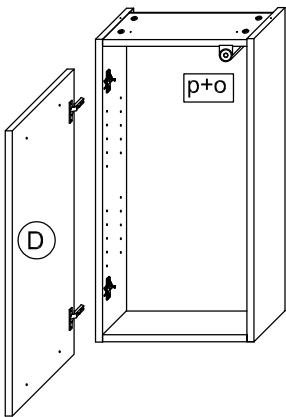

Bei Türmontage das Scharnier einhängen, bis Anschlag öffnen und anschließend festschrauben.

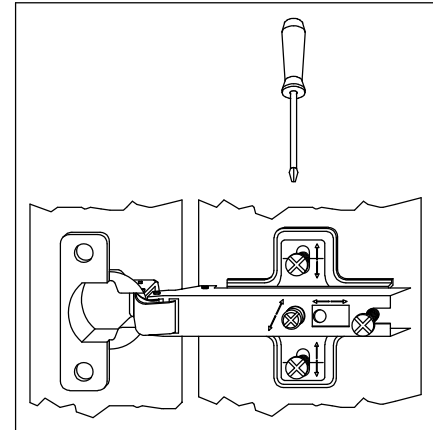
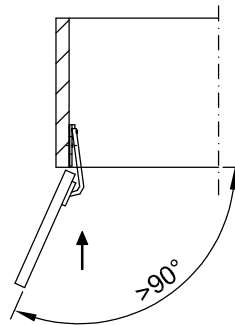

13.

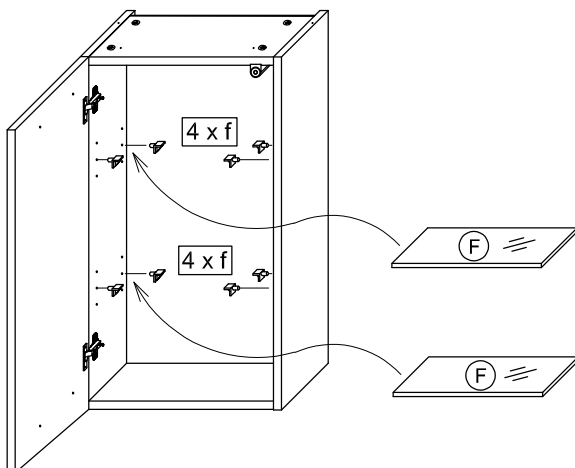

Das Möbel bitte nur mit einem feuchten Tuch reinigen.