

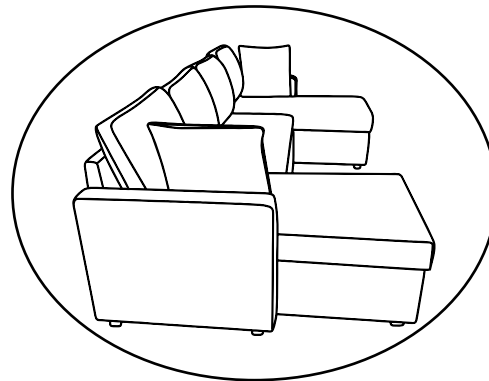

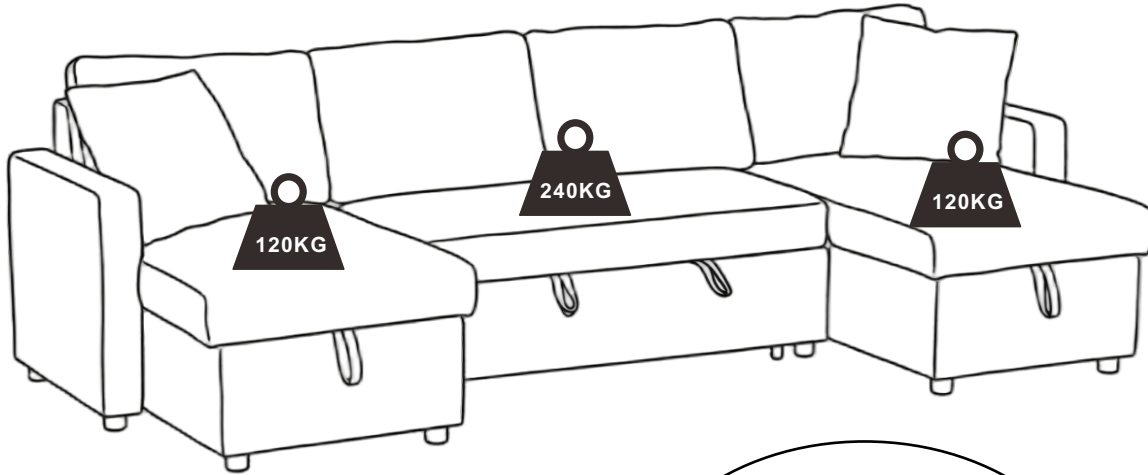



17730006/01











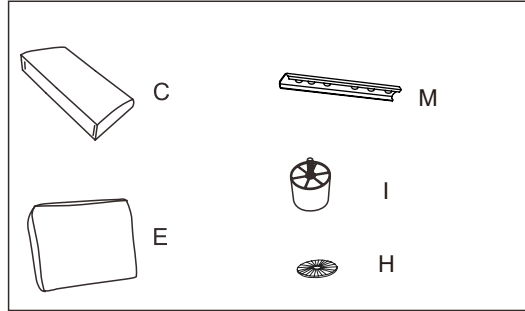
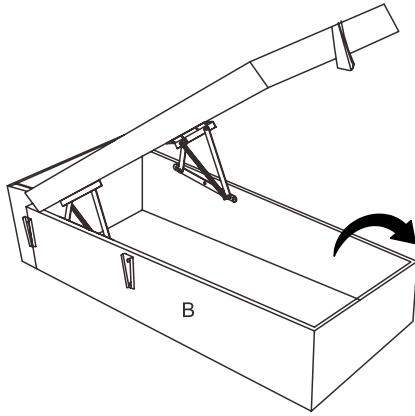





A x1	B x2	C x2	D x1	E x4	F x1
G x1	H x16	I x16	J x16	K x4	M x6
			M4*20MM		
N x1	P x2	W x2	Z x8	Q x2	
M6			M6*20MM		







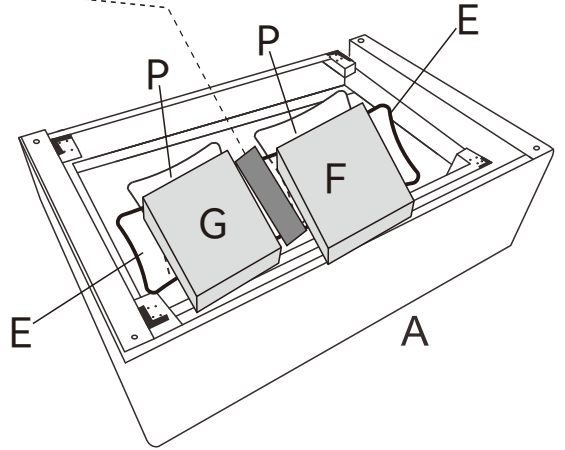
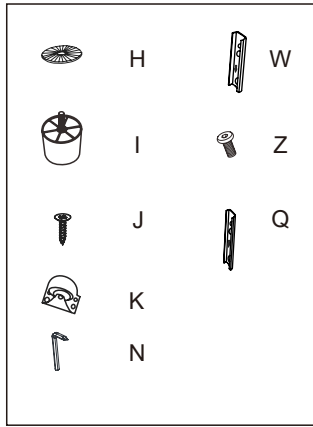

x2

Bx2 	Hx8 
Cx2 	Ix8 
Ex2 	Mx4 



Ax1 	Jx16 M4*20MM 	Wx2 	Gx1 
E x2 	Kx4 	Zx8 M6*20MM 	
Hx8 	Nx1 M6 	Qx2 	
Ix8 	Px2 	Fx1 	



Fx1 	Qx2 
Gx1 	Zx8 M6*20MM 
Wx2 	



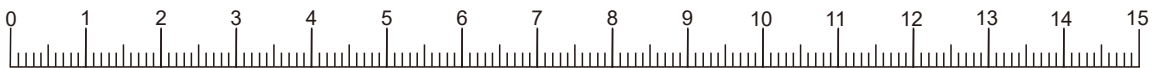
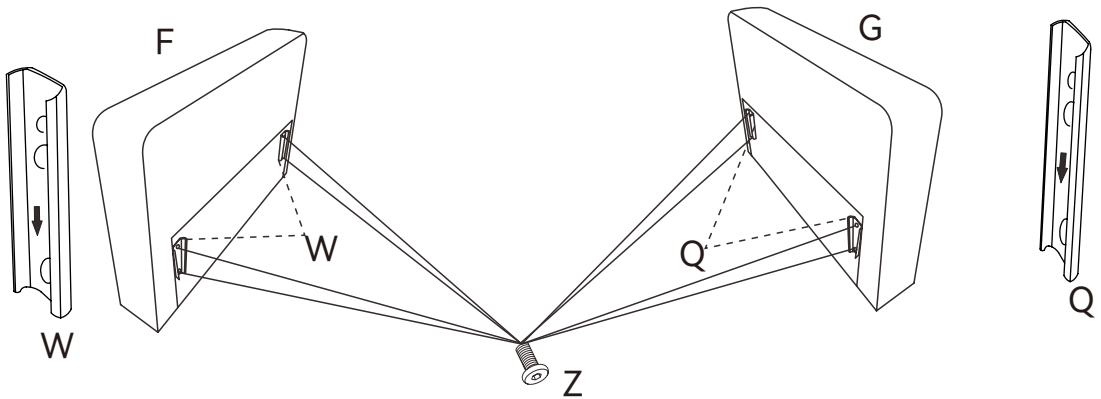



1

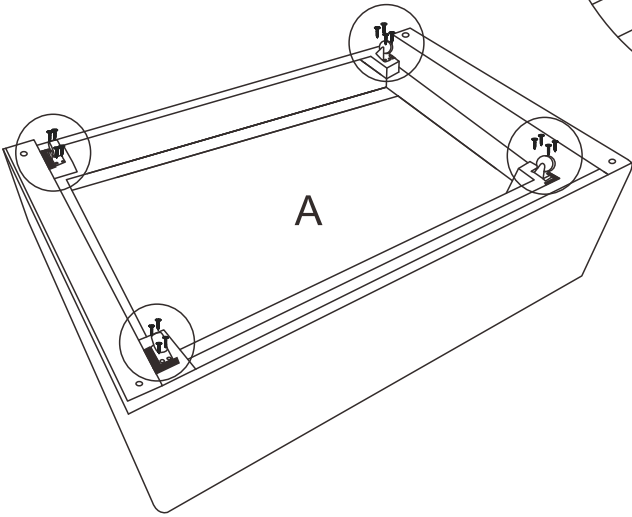
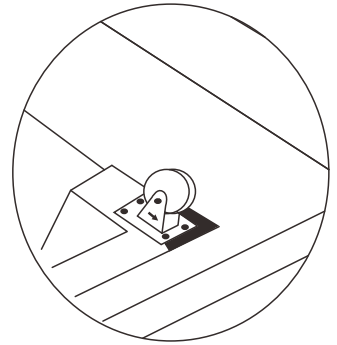
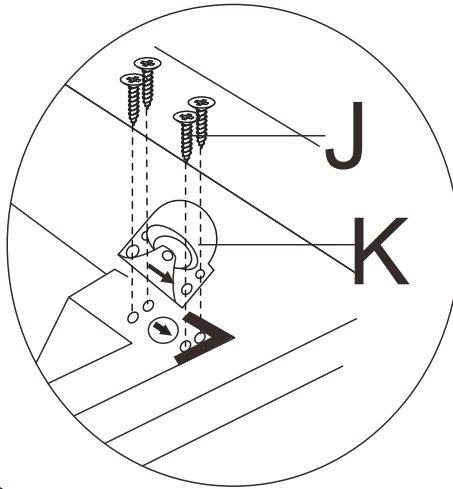

- Ax1 
- Jx16 
M4*20MM
- Kx4 

②



- Ax1 
- Bx2 
- Fx1 
- Gx1 
- Hx16 
- Ix16 

③

x2

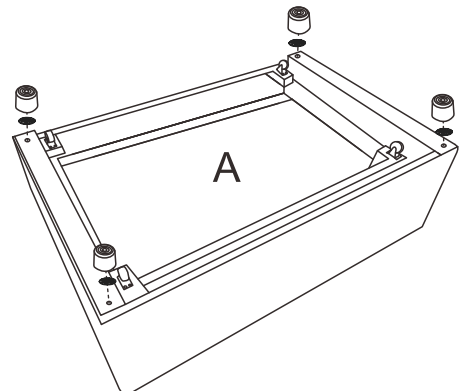
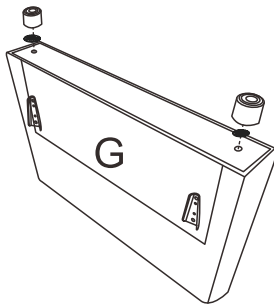
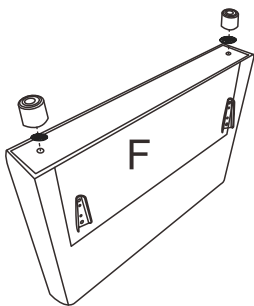
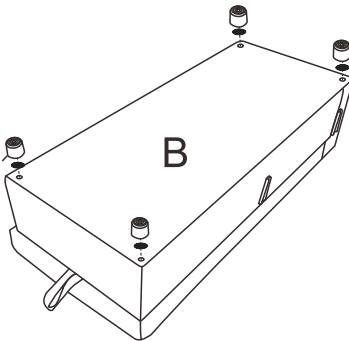
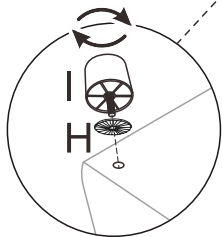

Ax1



Bx2



Cx2



Dx1



Mx6

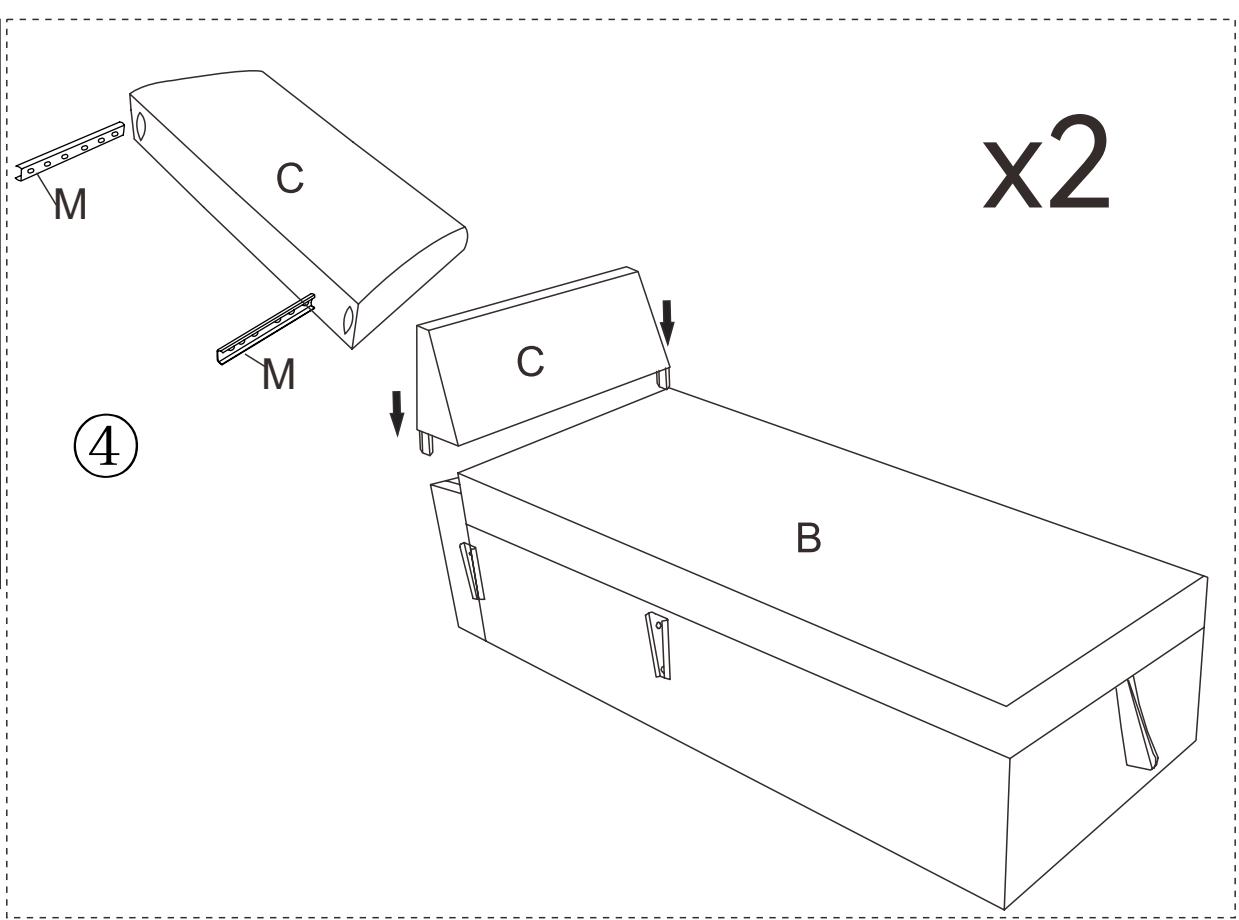

5

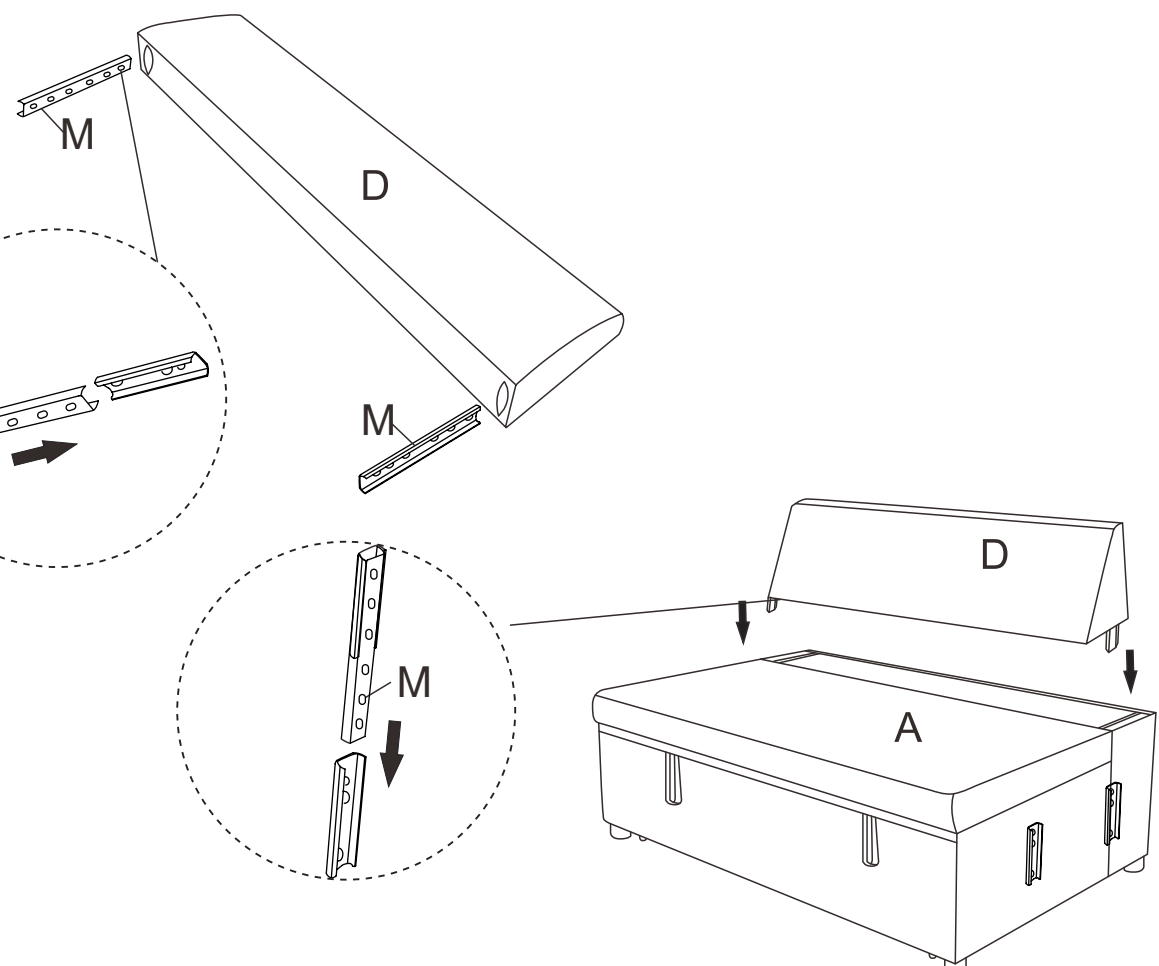

⑥

