

# UNIT ELEMENTS 41

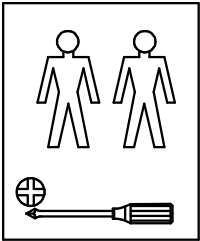

01	1550x453x16	x1	
----	-------------	----	--

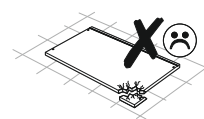
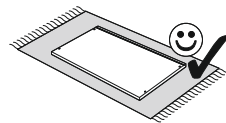
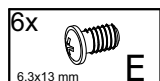
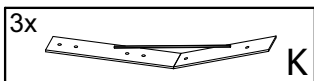
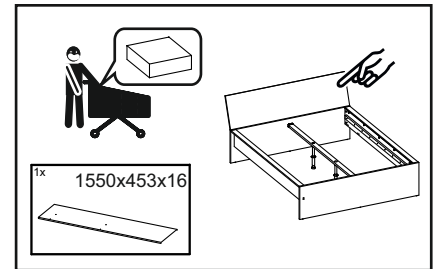
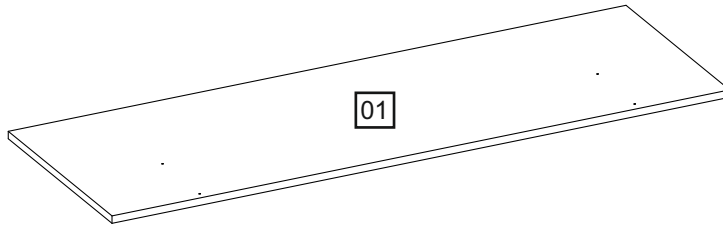
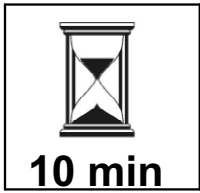

1

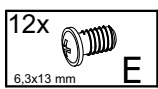
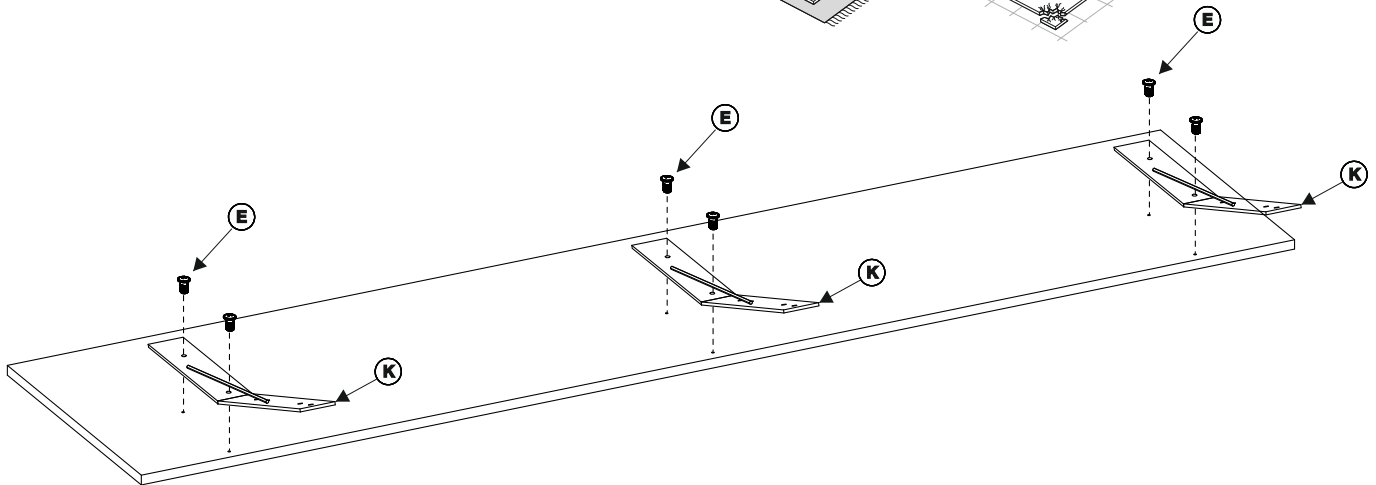

2

