

# Carmen, Deco

## Witryna niska 1W1D1S

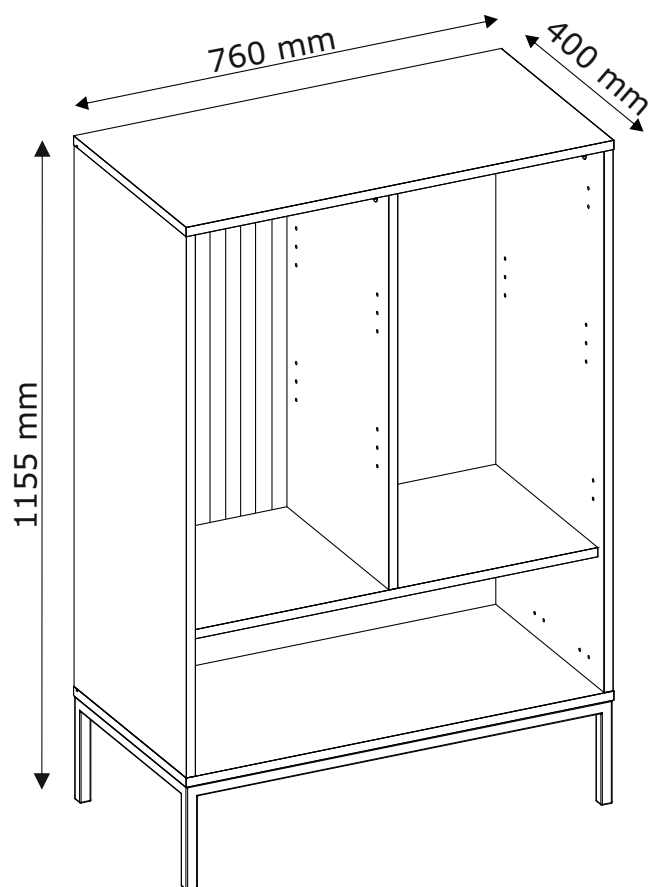

3026182

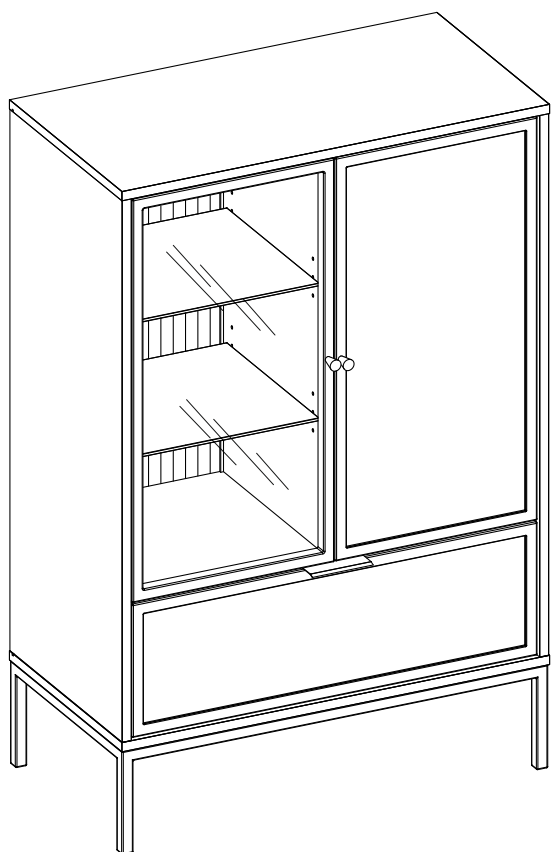
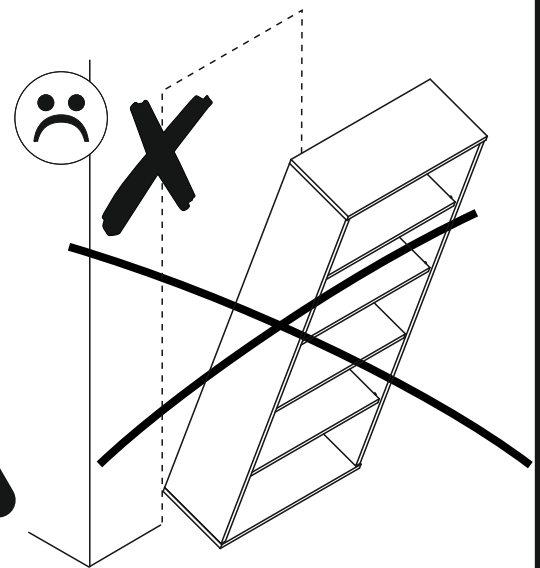
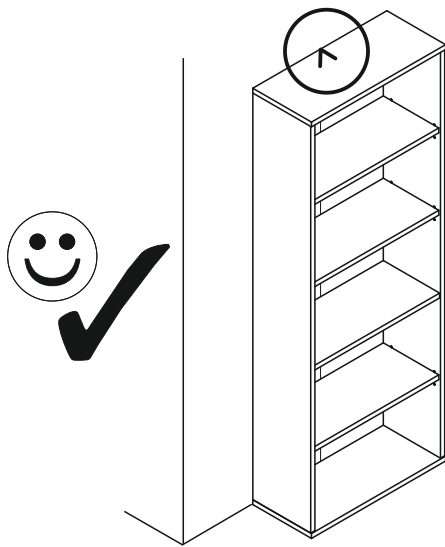

PL.

UWAGA! Mebel należy trwale zamocować do ściany, aby uniknąć ryzyka związanego z przewróceniem się mebla. W paczce znajdują się elementy mocujące odpowiednie wyłącznie do ścian betonowych lub z pełnej cegły. Jeśli Twoja ściana wykonana jest z innego materiału lub nie masz pewności co do budowy tej ściany, skonsultuj się w kwestii montażu ze specjalistą.

RU.

ПРИМЕЧАНИЕ! Эту мебель необходимо всегда прикреплять к стене, чтобы избежать рисков, связанных с переворотом мебели. В пакете находятся крепежные элементы, которые подходят исключительно к бетонным стенам или из целого кирпича. Если стена изготовлена из другого материала или Вы не уверены относительно строения стены, проконсультируйтесь относительно монтажа со специалистом.

I.

ATTENZIONE! Il mobile deve essere permanentemente fissato alla parete per evitare i rischi derivanti da un ribaltamento del mobile. La confezione contiene solo elementi di fissaggio adatti per pareti in calcestruzzo o in laterizio pieno. Se la vostra parete è realizzata in materiale diverso o avete dubbi sulla costruzione della parete, consultare uno specialista per un montaggio corretto.

SLO.

POZOR! Pohištvó trajno pritrđite na steno, da preprečíte tveganje, da se prevrne. V paketu so pritrđilni elementi, ki so ustrezni izključno za betonske stene in za stene iz polne opeke. Če je vaša stena izdelana iz drugih materialov ali niste gotovi glede konstrukcije stene, se o montaži posvetujte s strokovnjakom.

EN.

WARNING! To prevent this furniture from tripping over, fix it to the wall permanently. The package includes fastening elements only suitable for concrete or full-brick walls. If your wall is made of a different material or you are unsure as to the construction of the wall, please consult a specialist regarding installation.

FR.

ATTENTION! Ce meuble doit être fixé en permanence au mur pour éviter les risques de chute. L'ensemble comprend des moyens de fixation adaptés uniquement aux murs de béton ou de brique. Si votre mur est fait d'un matériau différent ou si vous êtes incertain quant à la construction du mur, consultez un spécialiste.

HR.

NAPOMENA! Namještaj mora biti trajno pričvršćen za zid, kako bi se izbjegao rizik od njegova prevrtanja. U paketu se nalaze elementi za pričvršćivanje prikladni isključivo za betonske zidove ili punu ciglu. Ako je Vaš zid izrađen od drugog materijala ili niste sigurni od čega je napravljen Vaš zid, konzultirajte se sa stručnjakom u vezi sa montažom.

CZ.

POZOR! Nábytek je nutné pevně připevnit ke zdi, abychom se vyhnuli riziku spojenému s jeho převrnutím. V balíčku se nacházejí připevňující prvky vhodné výhradně do betonových zdí nebo zdí z plných cihel. Pokud jsou Vaše zdi zhotoveny z jiného materiálu nebo si nejste jejich konstrukcí jisti, konzultujte otázku montáže se specialistou.

CN.

注意！本家具需要固定在墙上以免倒塌。本包所含有的固定部件仅适用于混凝土墙及整砖墙。欲使用在其他墙体或不确定墙体时，请向专家询问安装方式。

D.

ACHTUNG! Um alle mit dem Umkippen des Möbels verbundenen Risiken auszuschließen, muss das Möbel fest an der Wand verankert werden. Die im Paket enthaltenen Beschläge für die Wandbefestigung sind ausschließlich für Wände aus Beton oder Vollziegeln geeignet. Sollten die heimischen Wände aus anderem Baumaterial bestehen oder sollte es Zweifel in Hinsicht auf dieses Baumaterial geben, bitte eine Fachkraft zu Rate ziehen.

HU.

FIGYELEM! Rögzítse a bútorokat a falhoz, hogy elkerülje a bútor felborulásának kockázatát. A készletben kizárólag beton- vagy téglafalhoz használható kötőelemek találhatók. Ha a fal más anyagból készült, vagy ha nem tudja, milyen falak találhatók otthonában, forduljon szakemberhez.

SK.

POZOR! Nábytok musí byť trvalo pripevnený k stene tak, aby sa zamedzilo riziku prevrátenia. V balíku sa nachádzajú upevňovacie komponenty výlučne pre betónové steny alebo steny z plnej tehly. Ak je Vaša stena z iného materiálu alebo ak si nie ste istí, z čoho je stena vyhotovená, vyžiadajte si odbornú pomoc.

E.



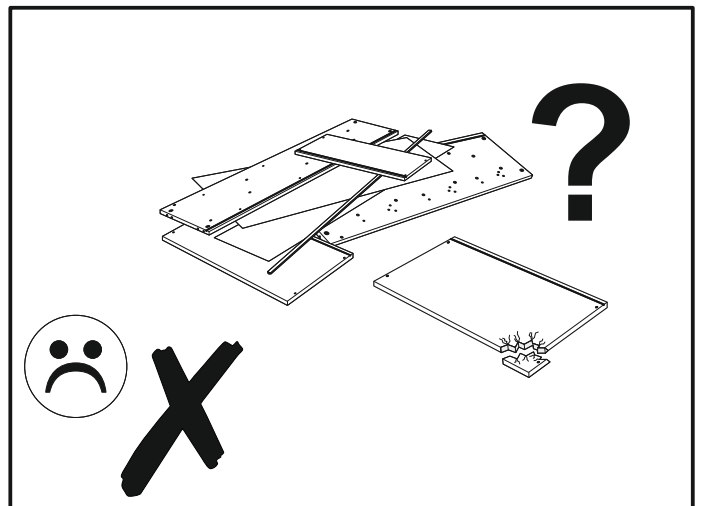
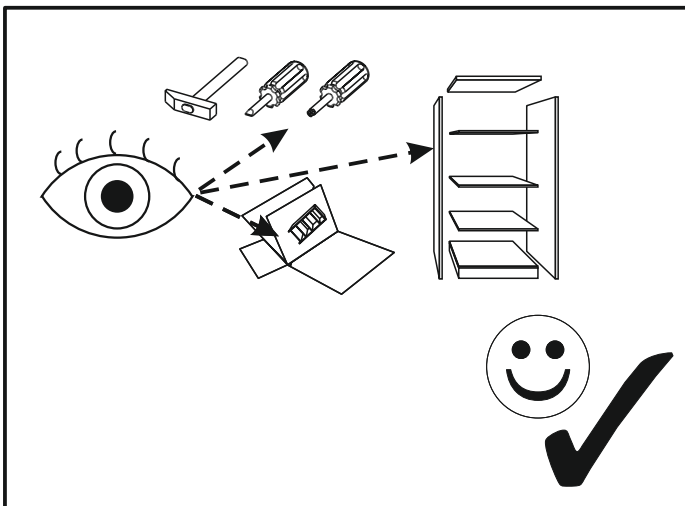
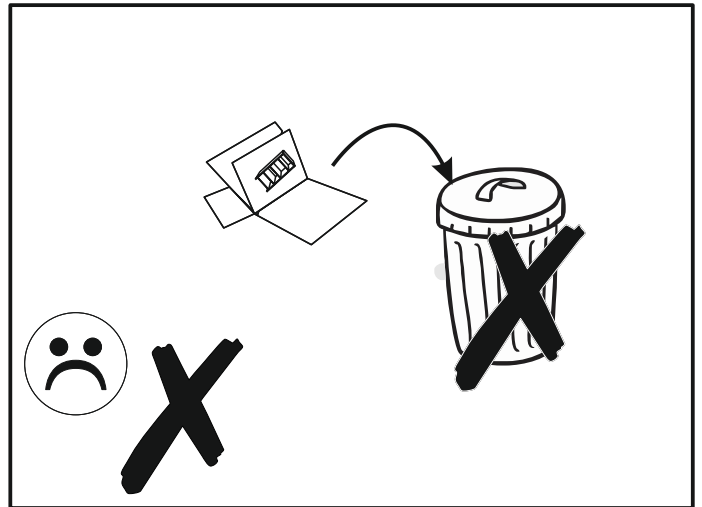
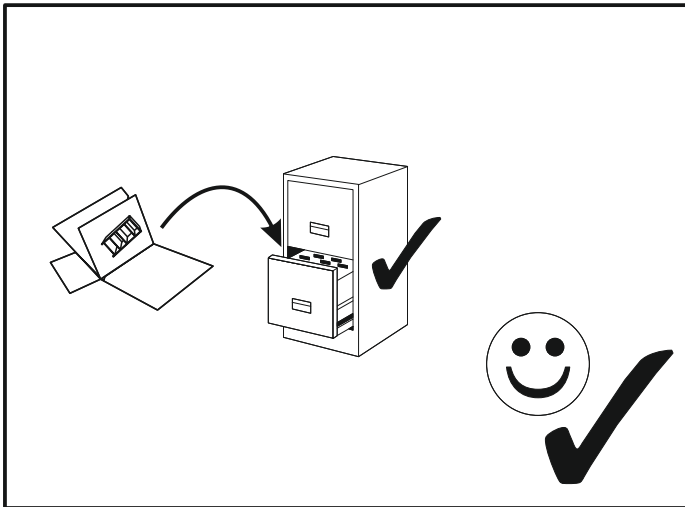
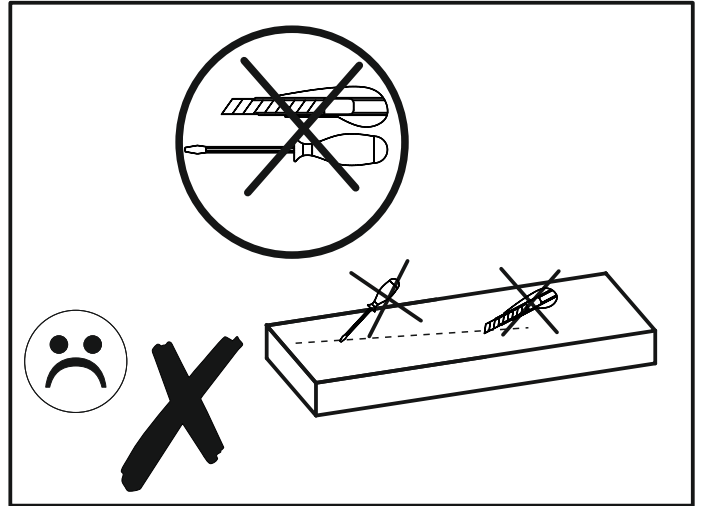
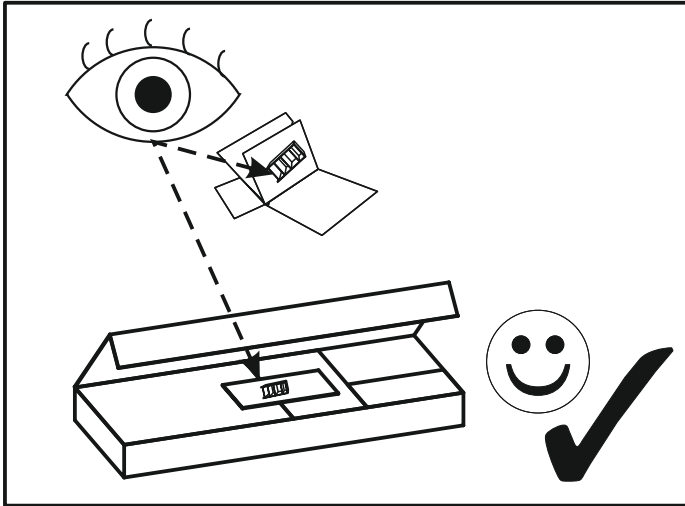

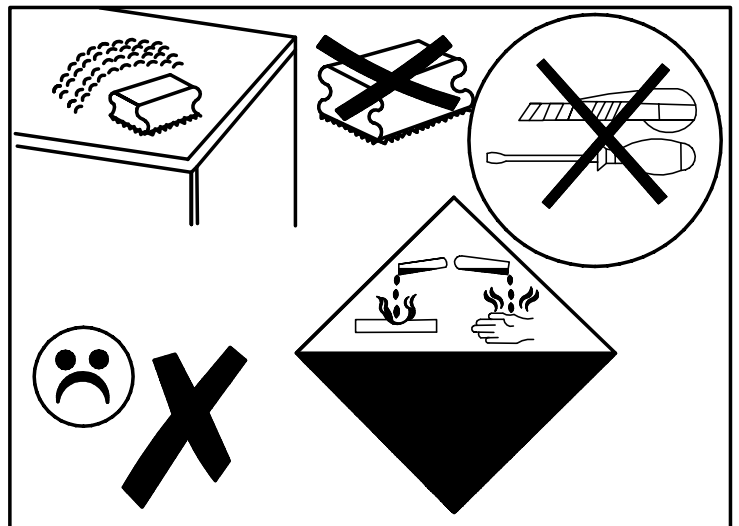
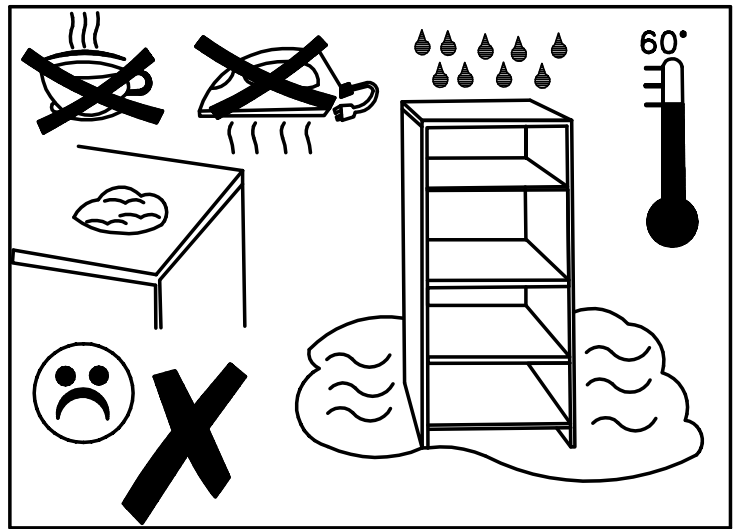
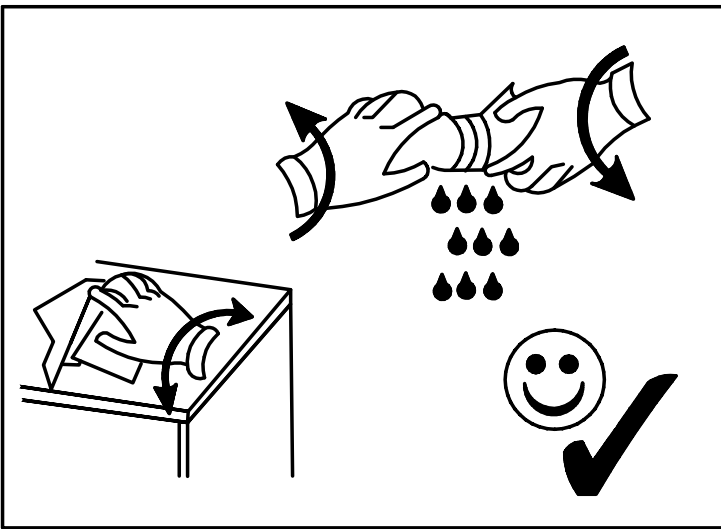
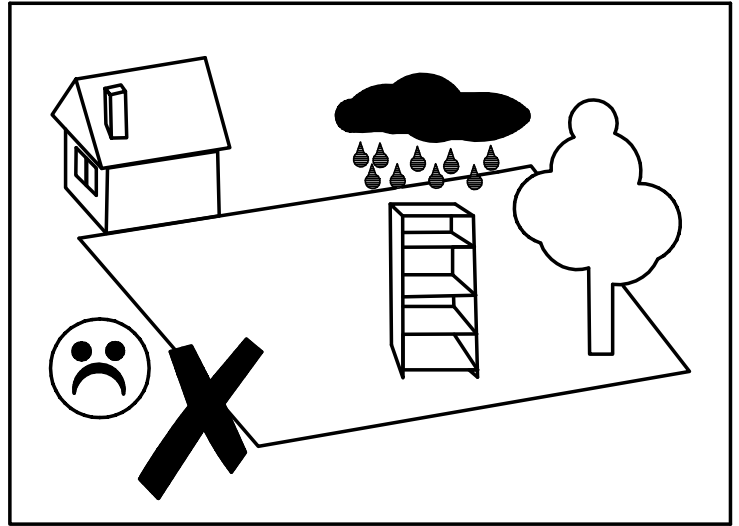
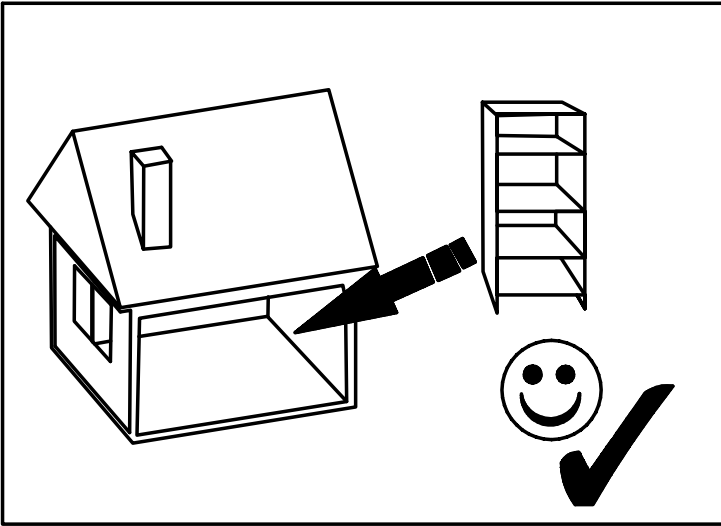

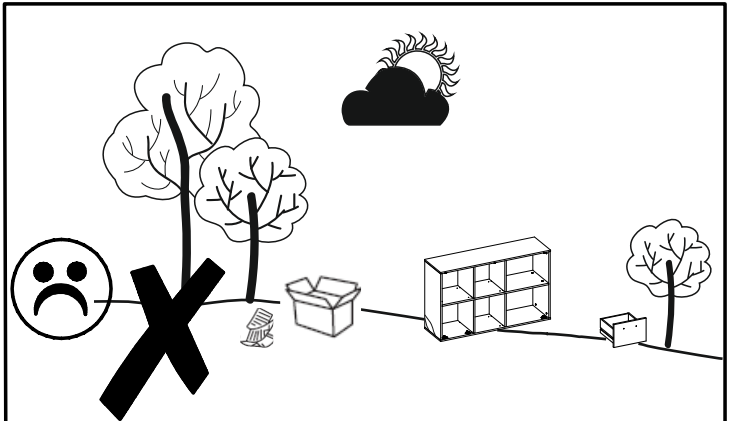
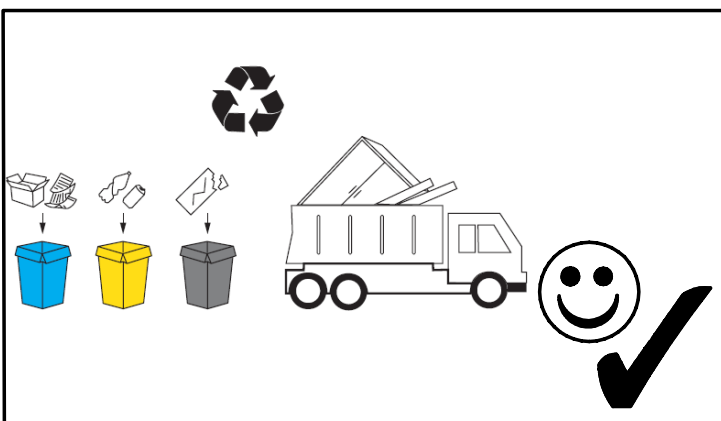
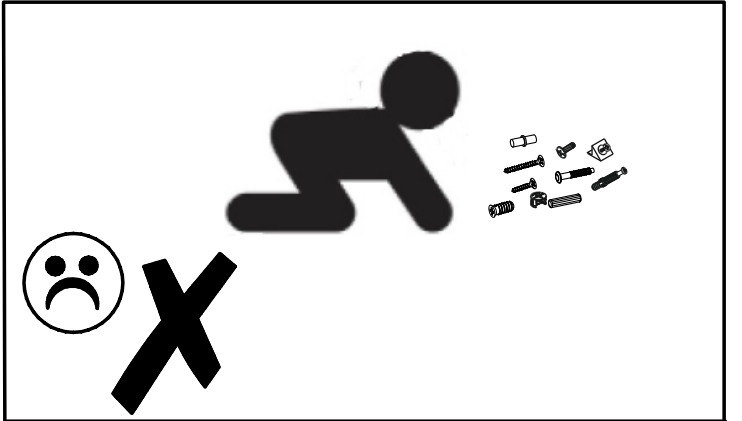
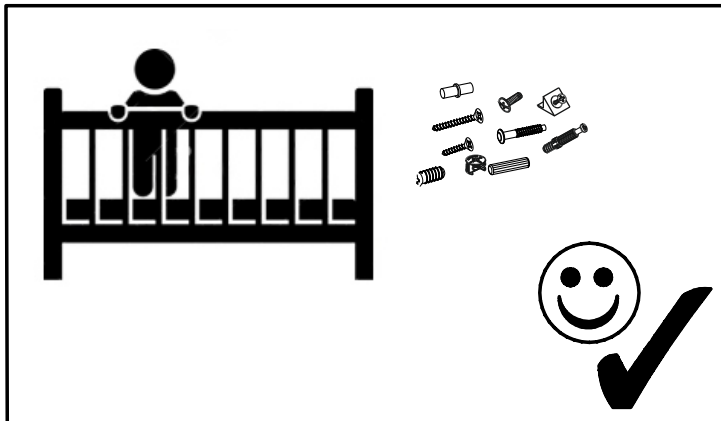
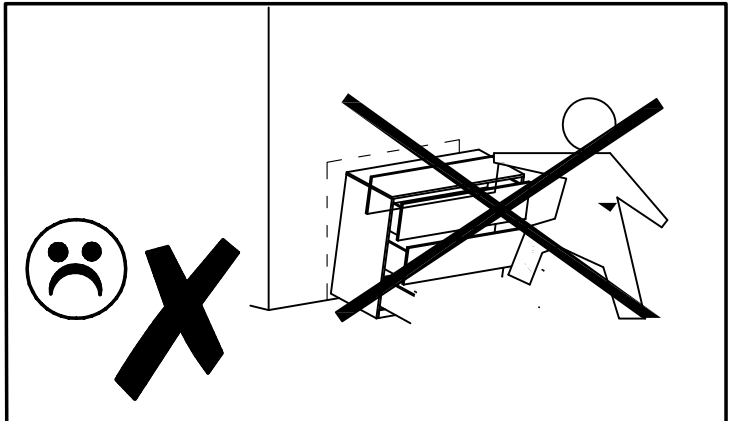
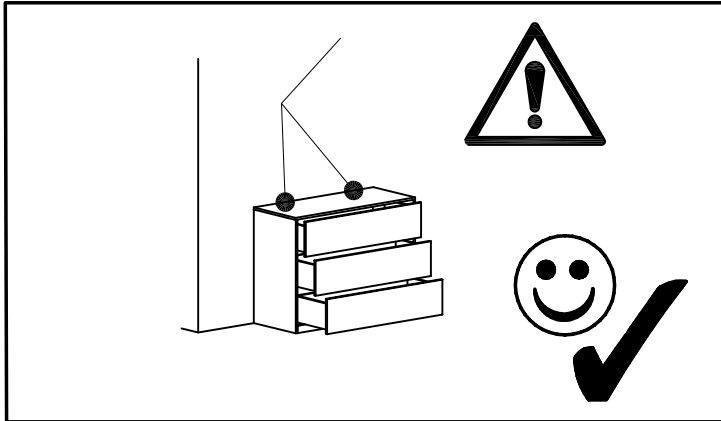
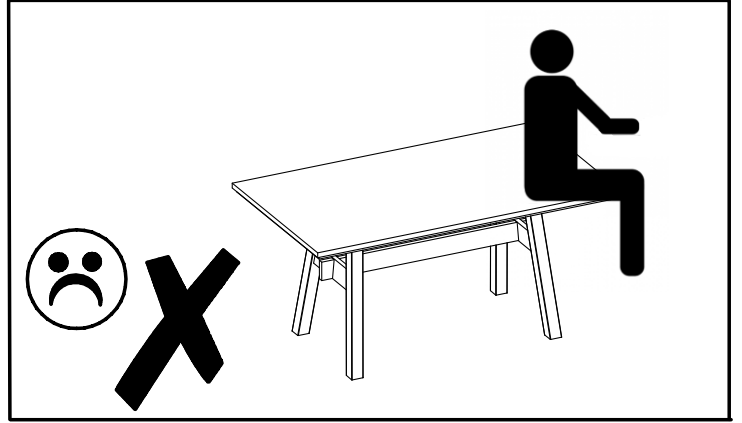
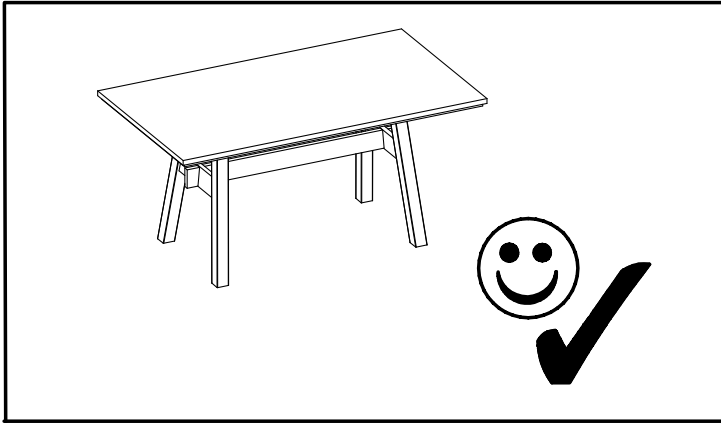
¡ATENCIÓN! El mueble debe ser fijado permanentemente a la pared para evitar el riesgo relacionado con el vuelco del mueble. En el paquete hay elementos de fijación adecuados solo para paredes de hormigón o de ladrillo entero. Si su pared está hecha de otro material o no está seguro sobre la construcción de esta pared, consulte el montaje con un especialista.

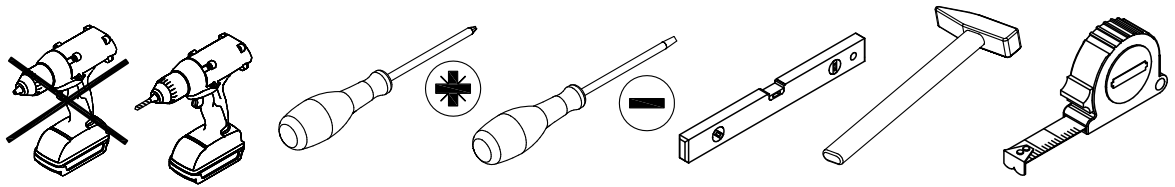

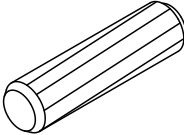
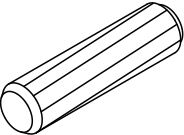
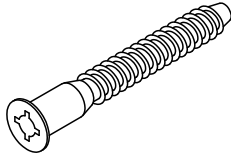
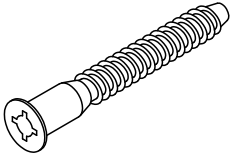

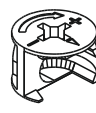
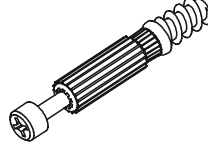
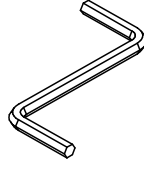

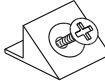
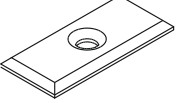
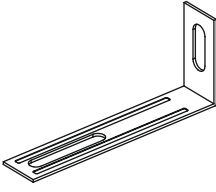
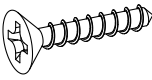
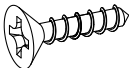
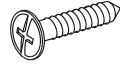

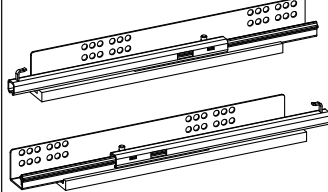
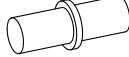
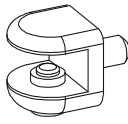
<p>A x 16 3003605</p>  <p>Ø8x35 mm</p>	<p>A1 x 4 3005048</p>  <p>Ø6x30 mm</p>	<p>B x 4 3000534</p>  <p>Ø7x50 mm</p>	<p>B2 x 4 3003334</p>  <p>Ø7x70 mm</p>
<p>C x 10 3001728</p>  <p>Ø15x12 mm</p>	<p>C1 x 4 3002649</p>  <p>Ø15x10 mm</p>	<p>D x 14 3002942</p>  <p>Ø5x44 mm</p>	<p>E x 1 3000331</p>  <p>4 mm</p>
<p>F x 6 3020881</p>  <p>20 mm</p>	<p>F1 x 4 3011364</p>  <p>20 mm</p>	<p>G2 x 10 3000344</p>  <p>1,2x25 mm</p>	<p>H x 10 3002435</p>  <p>22x9x2 mm</p>
<p>I x 1 3002892</p> 	<p>J x 1 3000564</p>  <p>3,5x16 mm</p>	<p>J1 x 5 3000573</p>  <p>3,5x13 mm</p>	<p>L1 x 15 3003843</p>  <p>3x20 mm</p>
<p>M1 x 8 3000564</p>  <p>Ø6,3x13 mm</p>	<p>N8 x 1 3000321</p>  <p>350 mm</p>	<p>O x 4 3000454</p>  <p>Ø5mm</p>	<p>O2 x 8 3003216</p>  <p>Ø5mm</p>

P x 1  
3022484

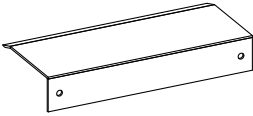

P1 x 2  
3023274

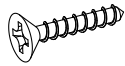

2,5x12 mm

P2 x 2  
3028018

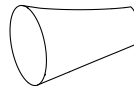

P3 x 1  
3000553

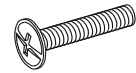

P4 x 1  
3026787

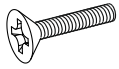

Z2 x 2  
3002656



4x35 mm

R6 x 2  
3015877

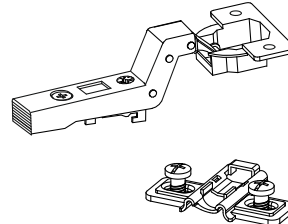

R10 x 2  
3026813

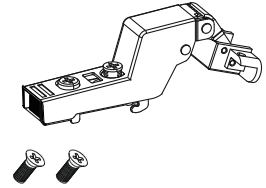

R11 x 2  
3026845

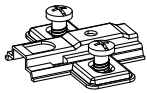

S x 4  
3011837



AK x 1  
3022351

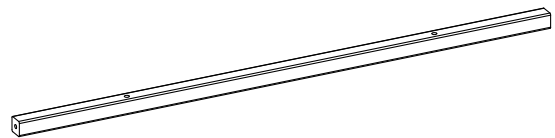

Ak1 x 1  
3023250

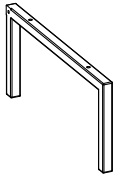

Ak2 x 1  
3023275

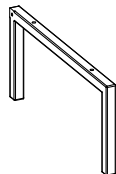

Ak3 x 1  
3023279

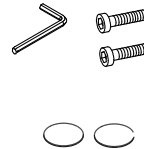

LED x 1  
3025278

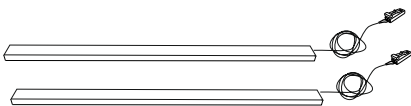

LED1 x 1  
3026198

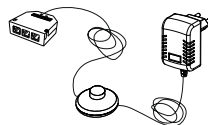

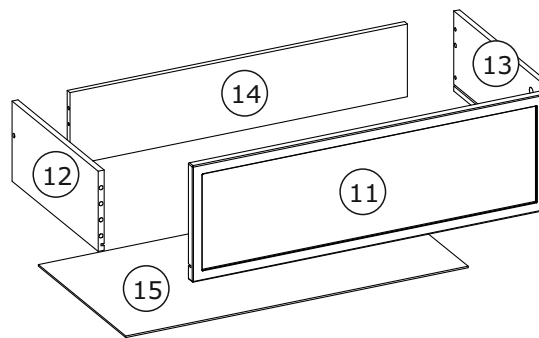
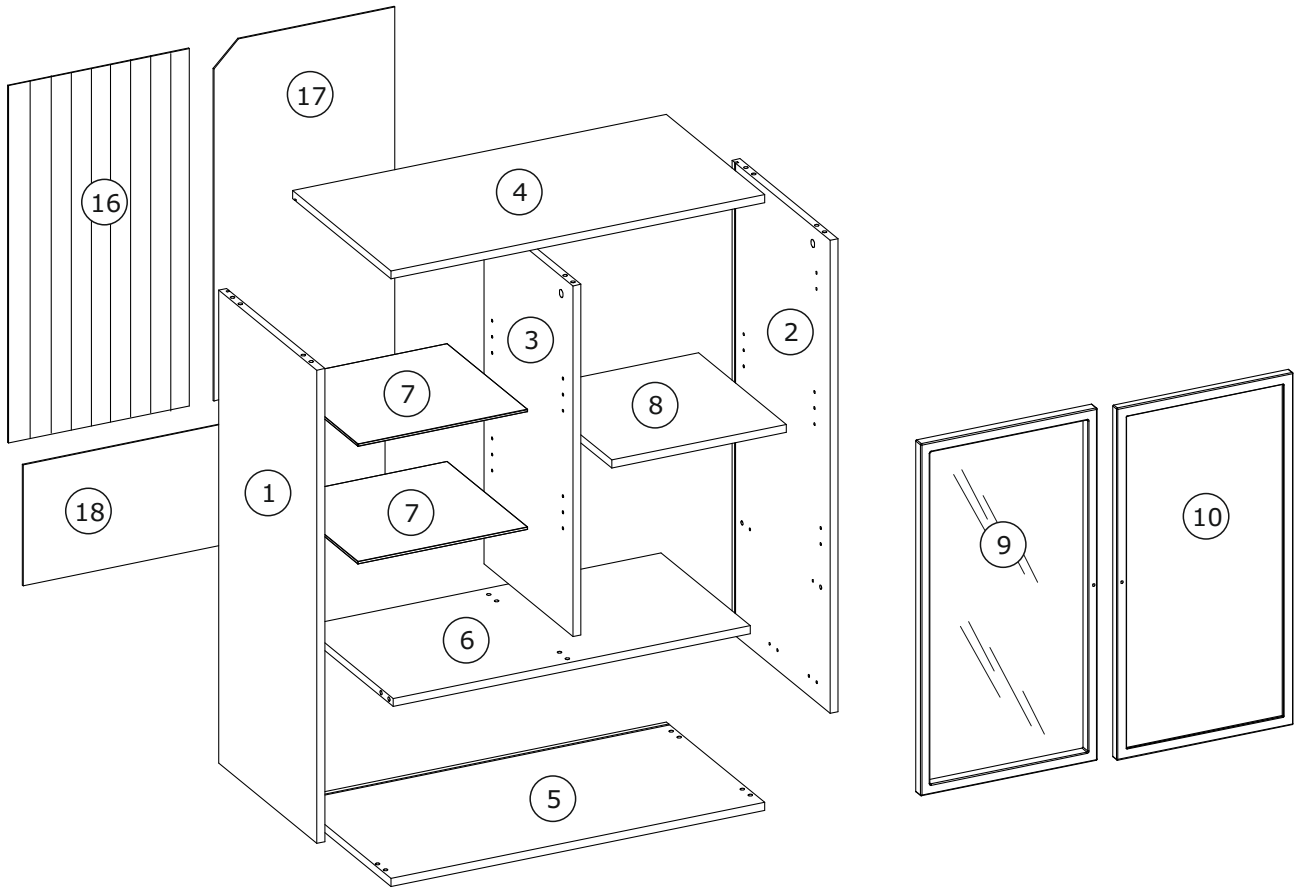
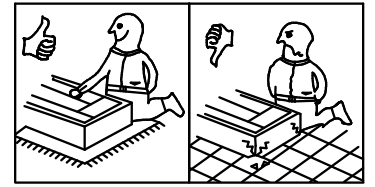

## BOX 1/2:

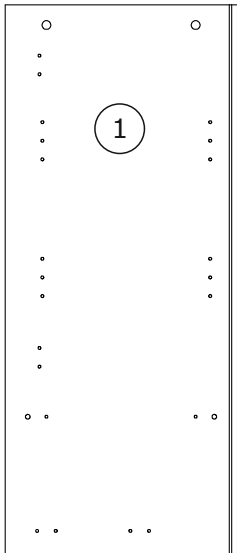

943x399x16 mm

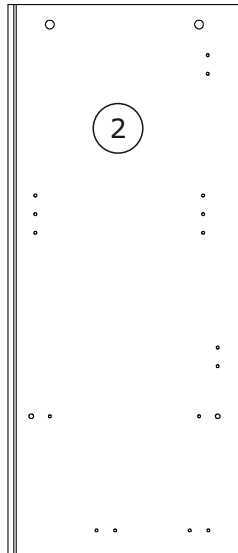

943x399x16 mm

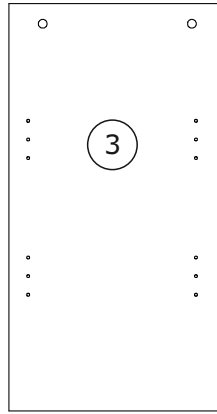

699x362x16 mm

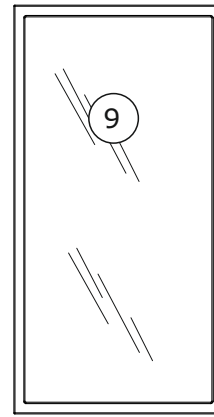

702x359x21 mm

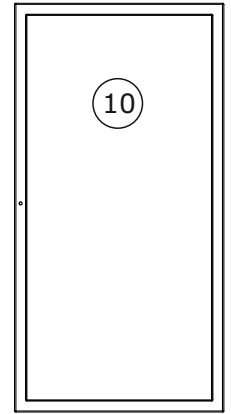

702x359x17 mm

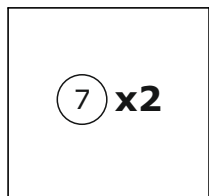

345x327,5x5 mm

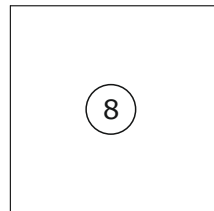

356x355x16 mm

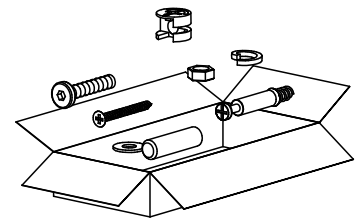

## BOX 2/2:

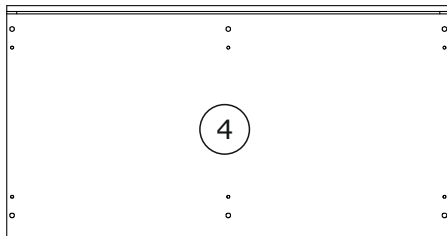

760x400x16 mm

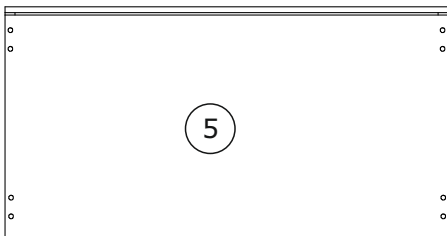

760x400x16 mm

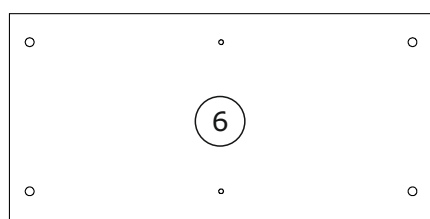

726x363x16 mm

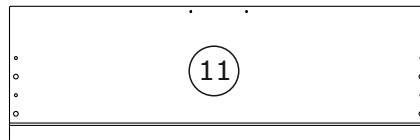

720x230x17 mm



686x145x12 mm

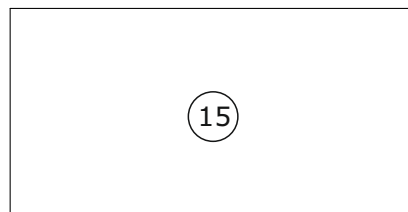

696x356x3 mm

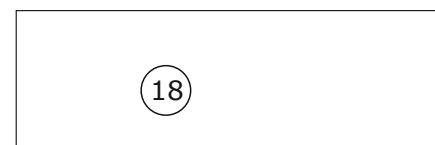

241x736x3 mm



350x160x12 mm

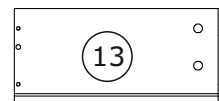

350x160x12 mm

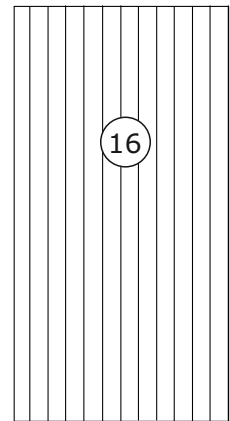

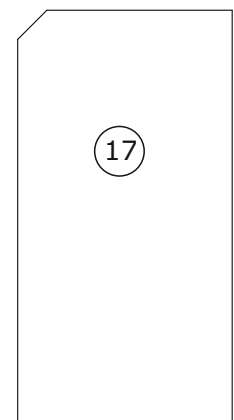

712x368x3 mm

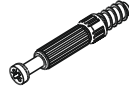
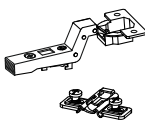

712x368x3 mm

1

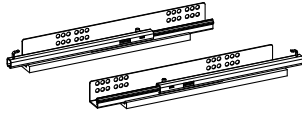
A x 12  Ø8x35 mm	D x 4  Ø5x44 mm	R6 x 2 	R11 x 2 	M1 x 8  Ø6,3x13 mm	N8 x 1  350 mm
---	--	---	--	--	---

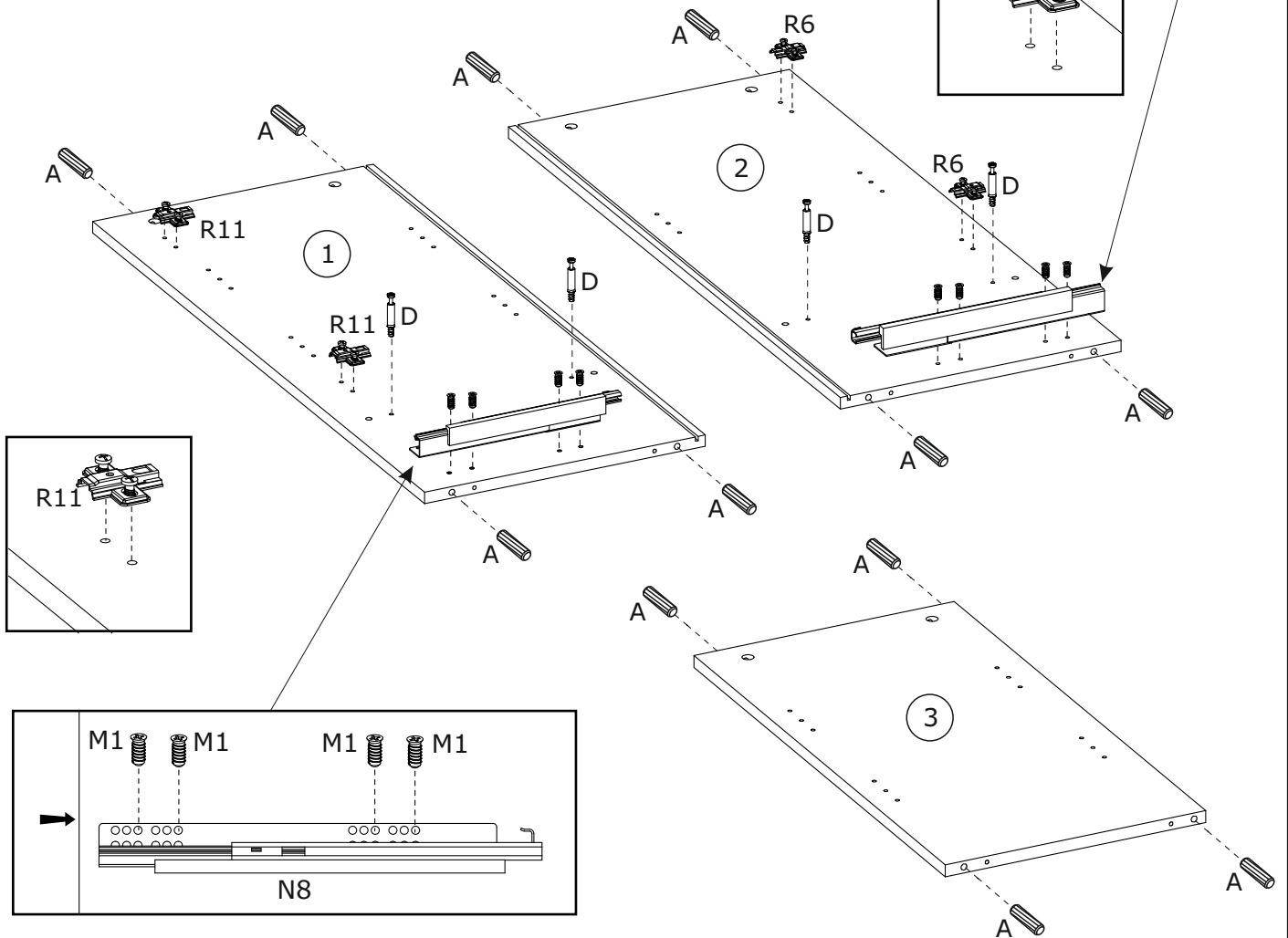
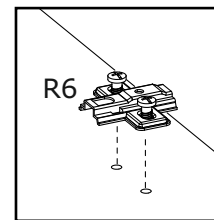
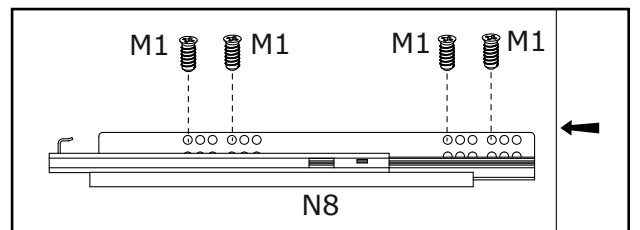
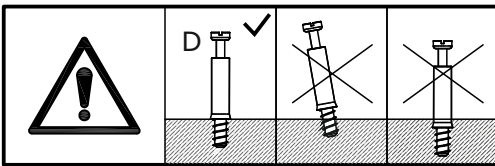
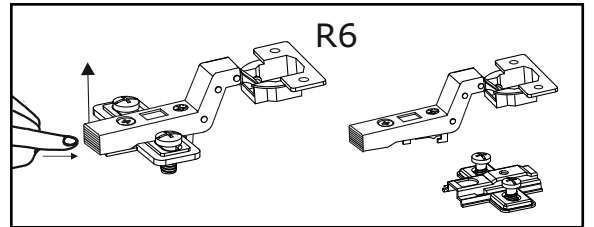
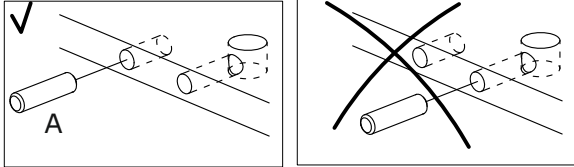
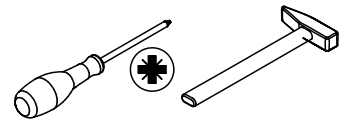

2

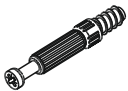
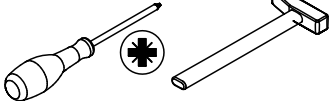
A x 4  Ø8x35 mm	D x 6  Ø5x44 mm	
--	--	---

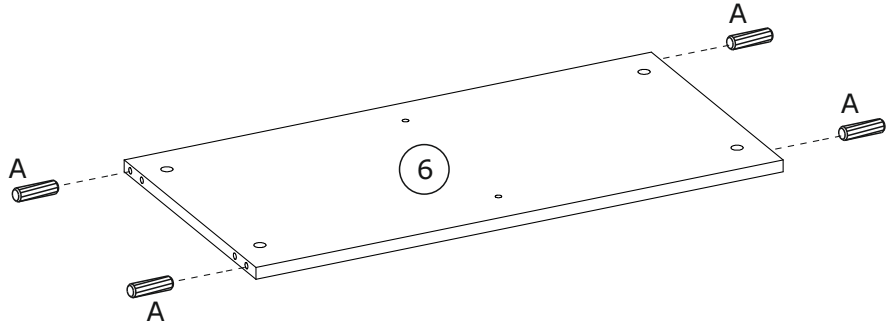
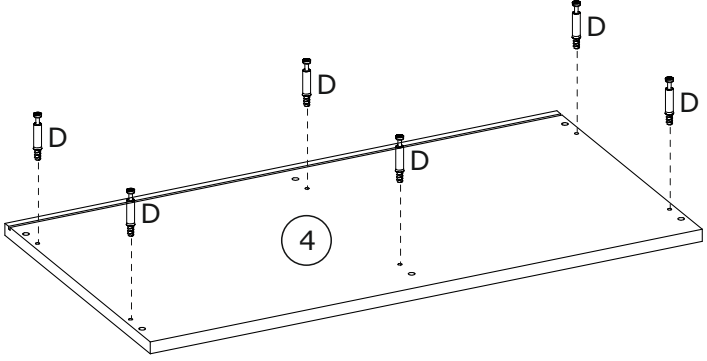

3

B x 2  Ø7x50 mm	E x 1  4 mm	
--	--	--

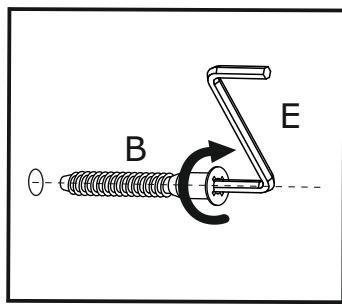
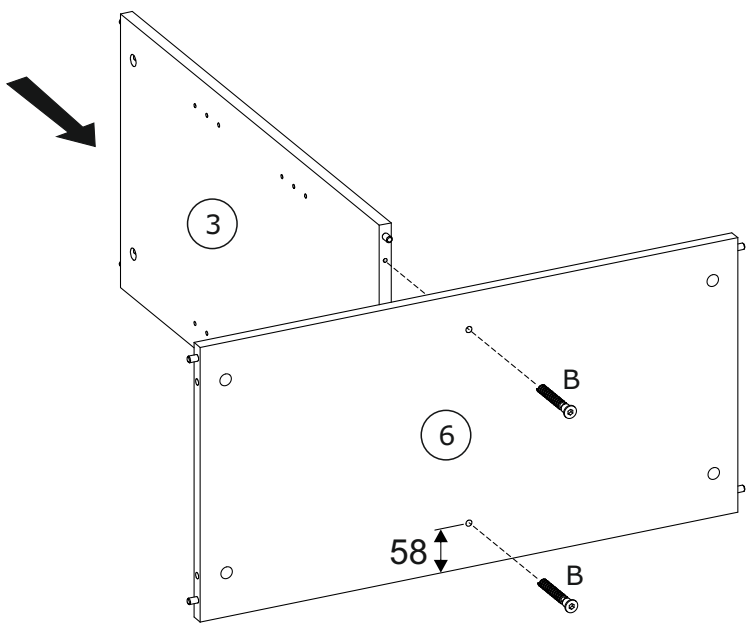
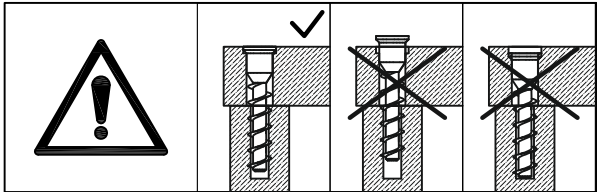

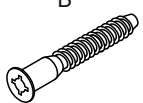
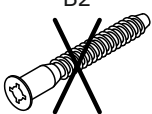
	B  Ø7x50 mm	<del>B2</del>  Ø7x70 mm
--	--	--

4

C x 4  
  
Ø15x12 mm

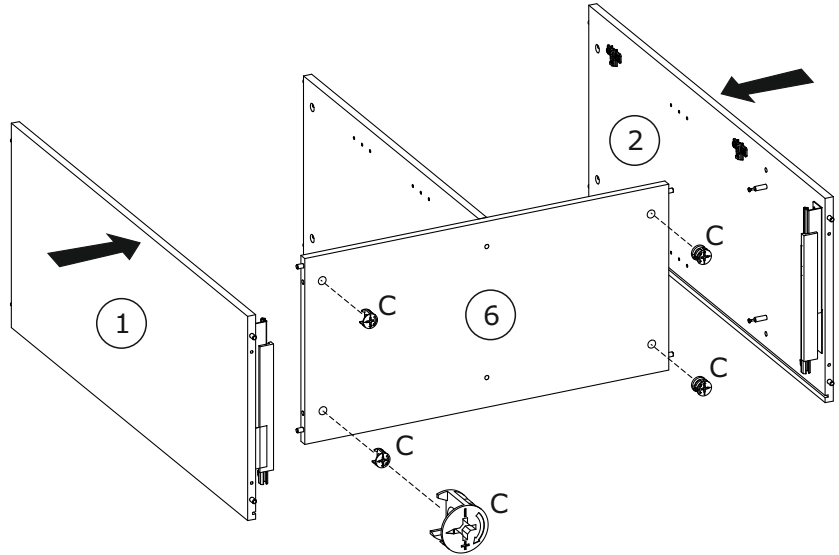
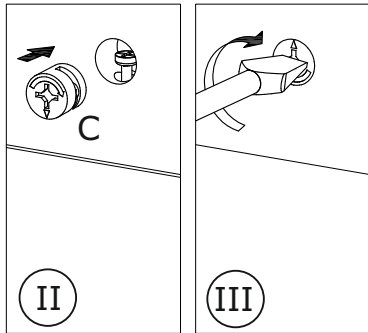
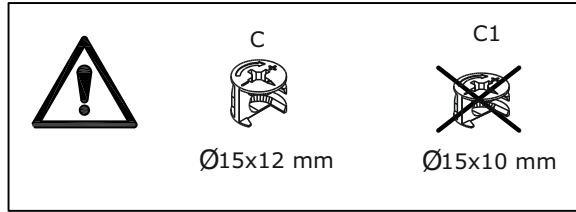
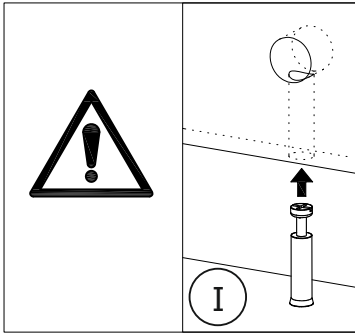
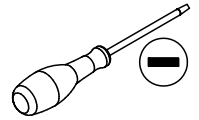

5

C x 6  
  
Ø15x12 mm

F x 6  
  
20 mm

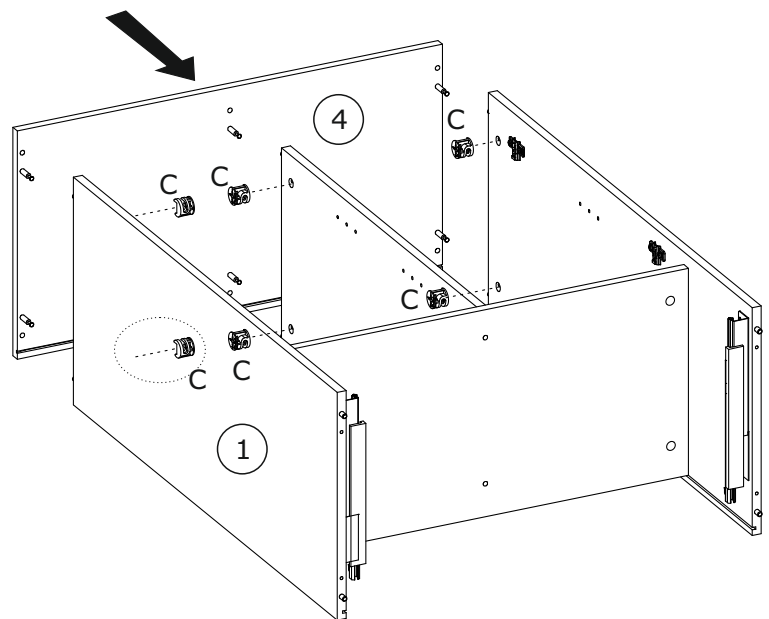
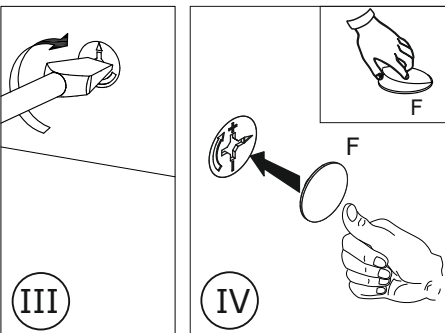
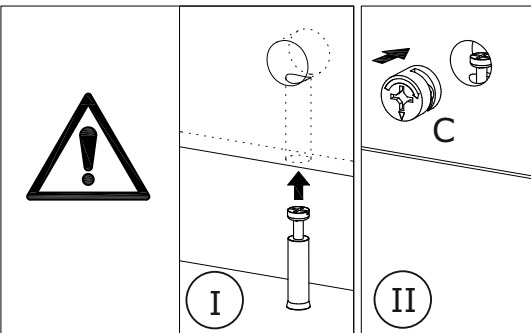
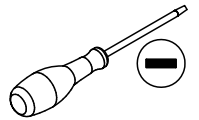

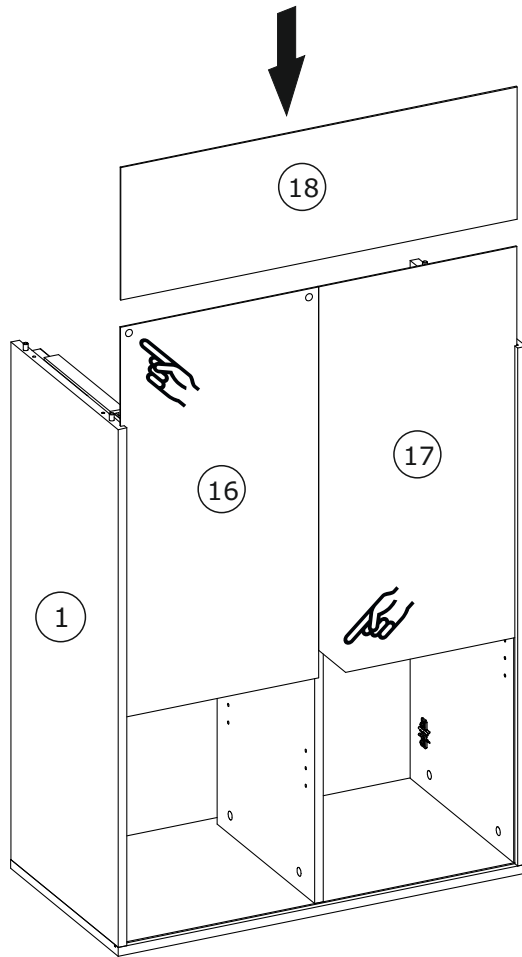

6

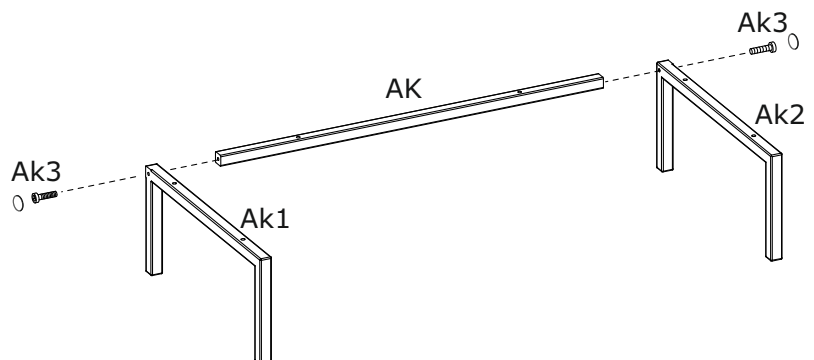
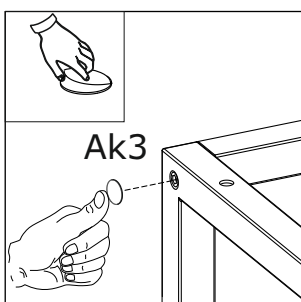
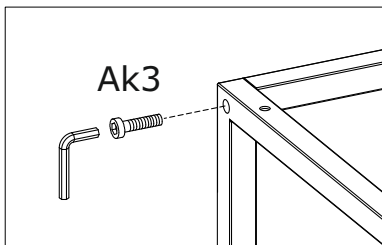
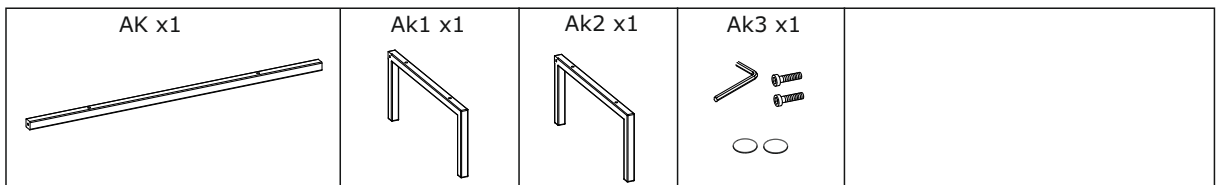

7



8

Z2 x 2  4x35 mm	B2 x 4  Ø7x70 mm	E x 1  ● 4 mm	
--	---	--	---

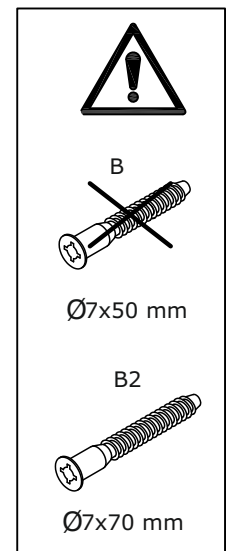
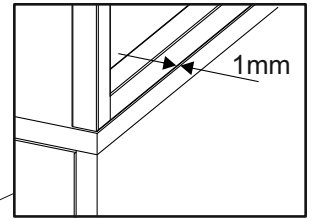
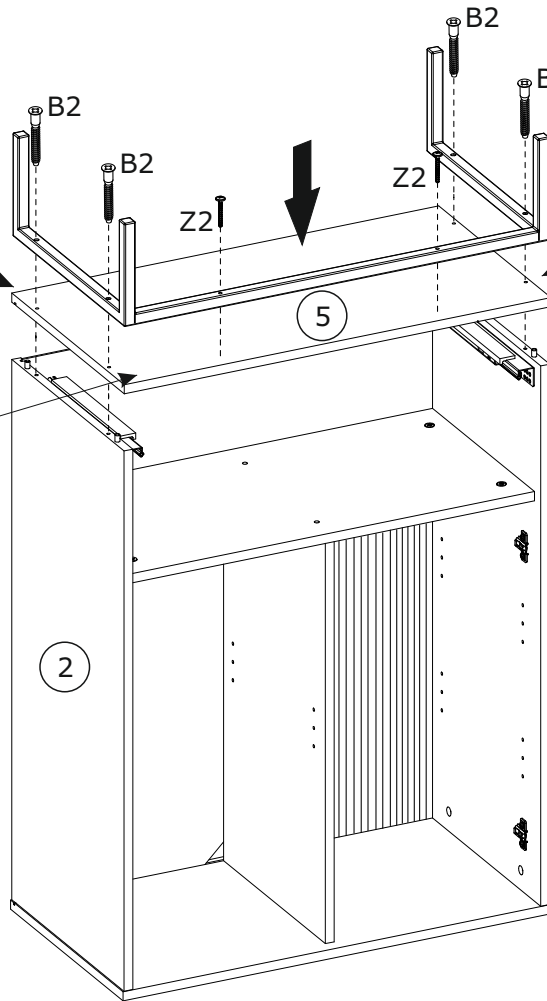
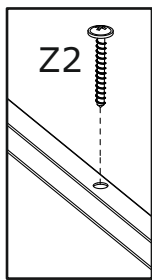
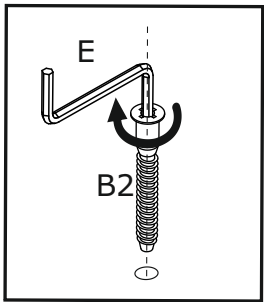
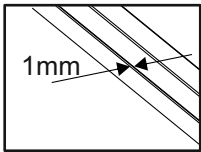
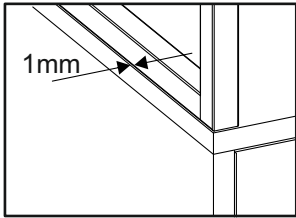

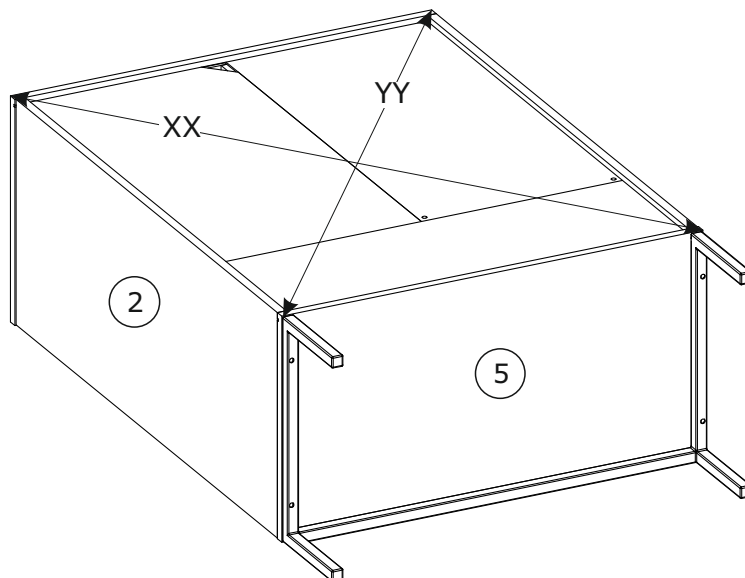

9

  $XX = YY \equiv 90^\circ$

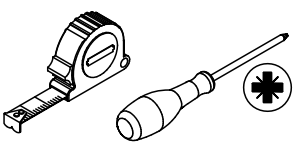

# 10

<p>H x 10</p>  <p>22x9x2 mm</p>	<p>G2 x 10</p>  <p>10x10 mm</p>	<p>L1 x 10</p>  <p>Ø3x20 mm</p>	
--	--	--	---

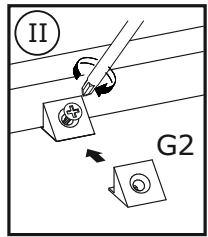
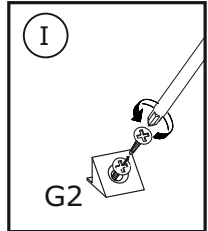
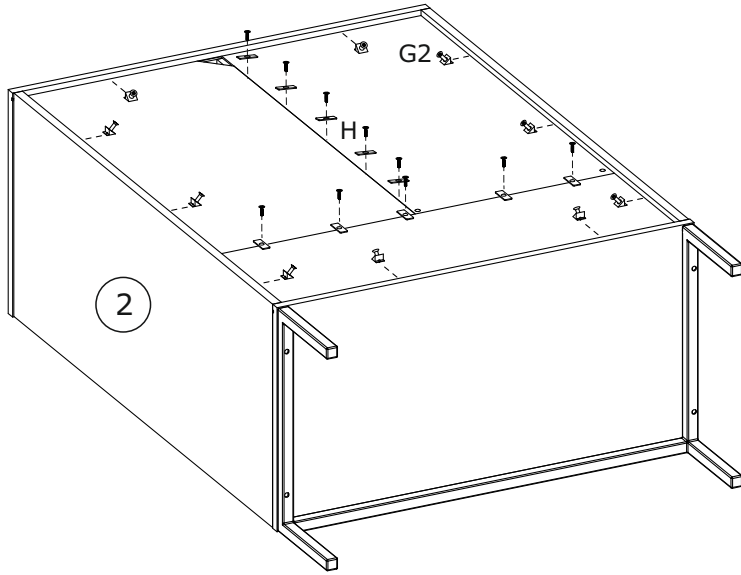
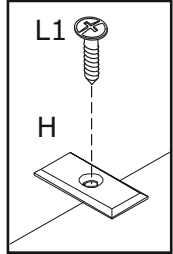



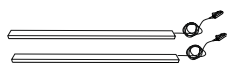
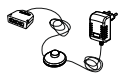

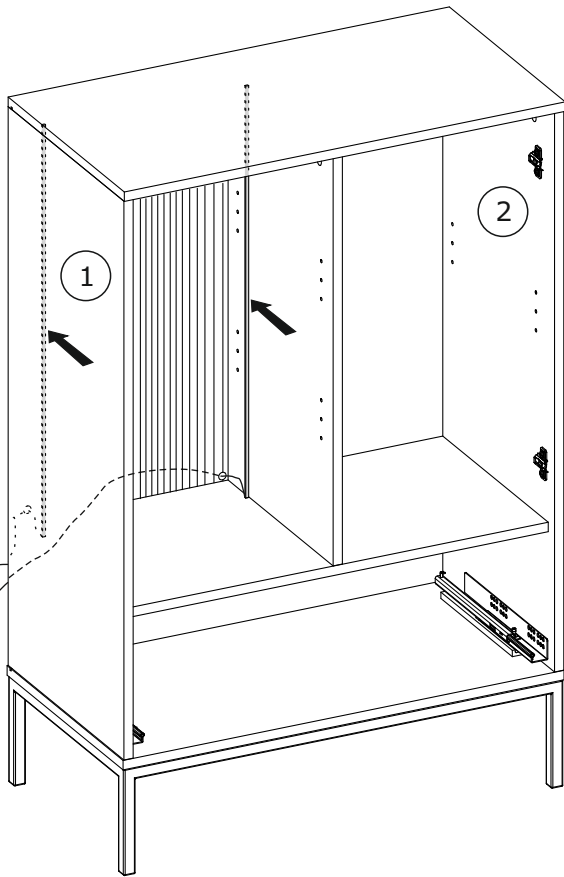
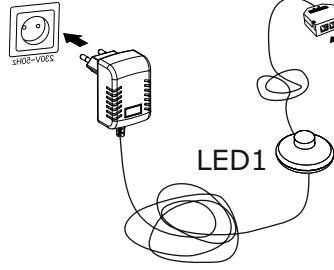
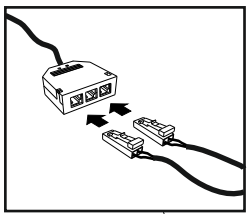
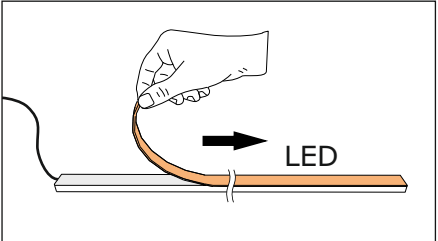

# 11

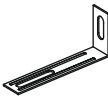
<p>LED x 1</p> 	<p>LED1 x 1</p> 	
--	---	--



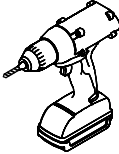
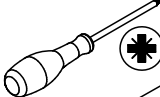

12

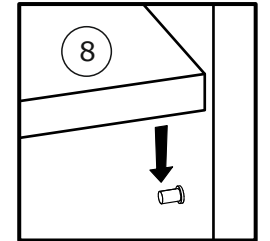
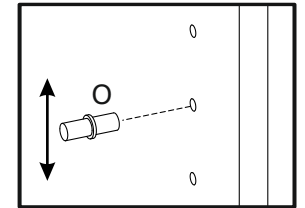
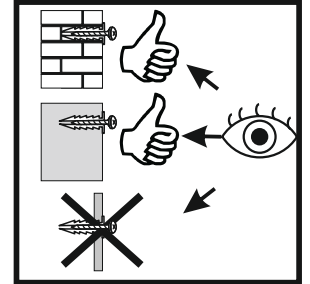
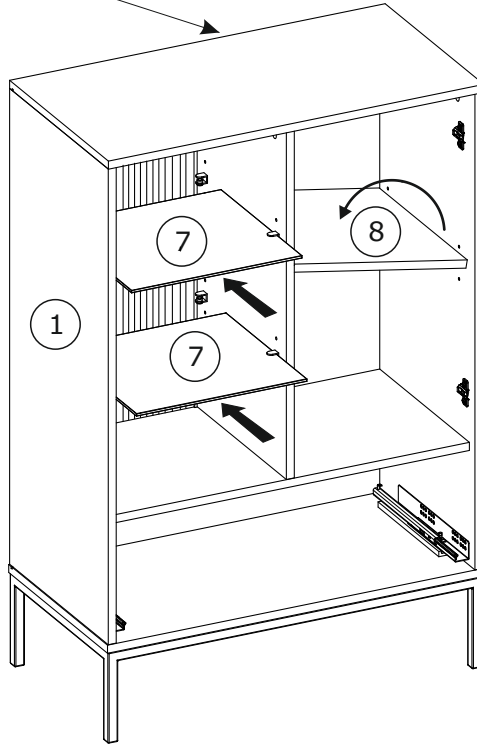
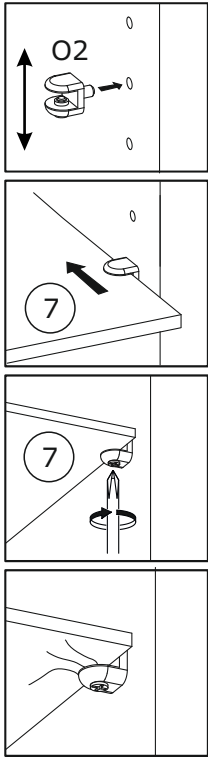
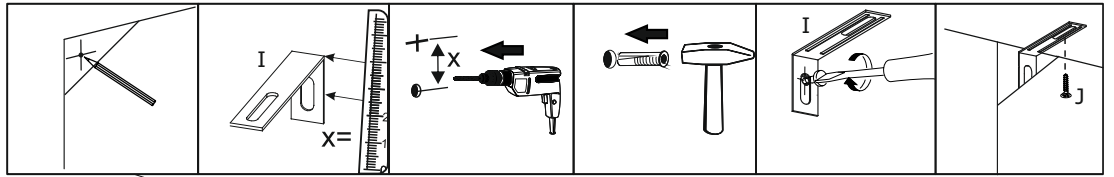
I x 1 	J x 1 3,5x16 mm 	O x 4 Ø5mm 	O2 x 8 Ø5mm 	  
--	---	--	---	---

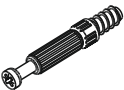

13

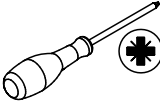
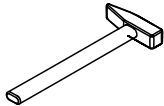
D x 4 Ø5x44 mm 	A1 x 4 Ø6x30 mm 	S x 2 	 
--	---	--	--

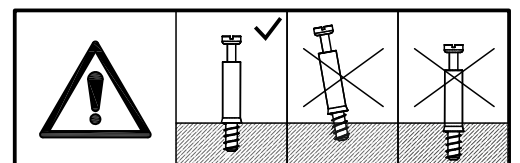
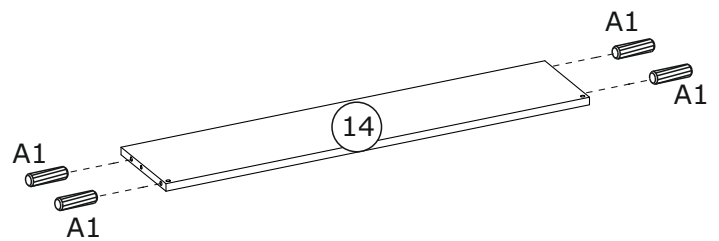
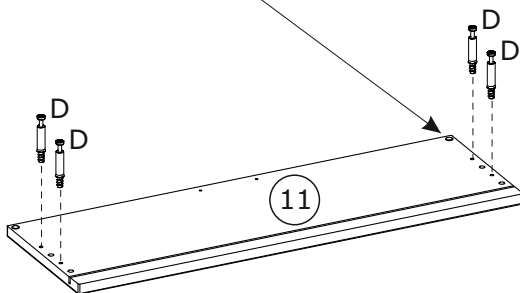
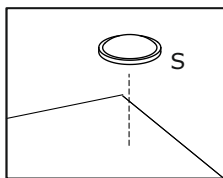

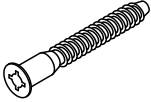
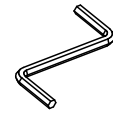

14

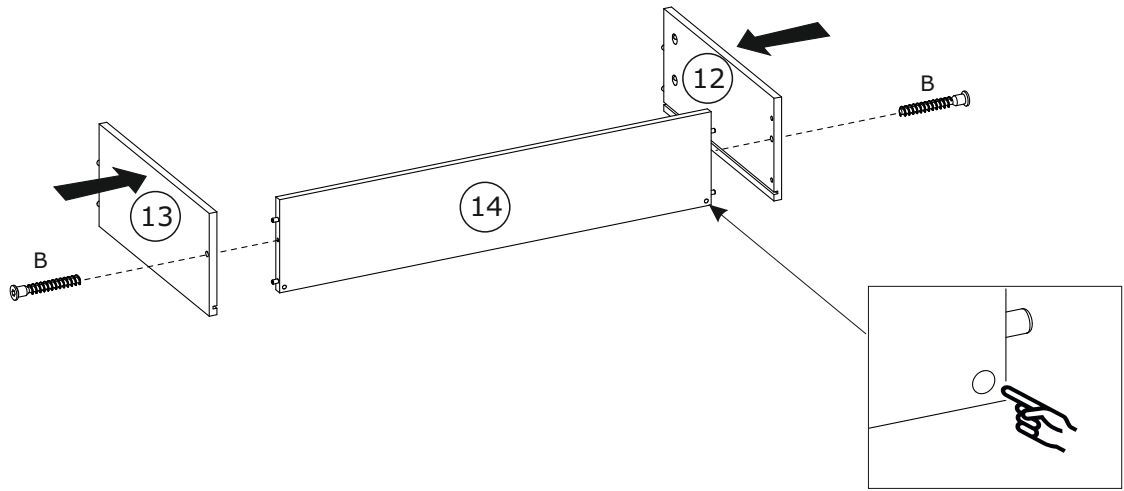
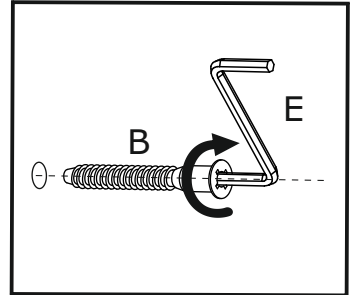
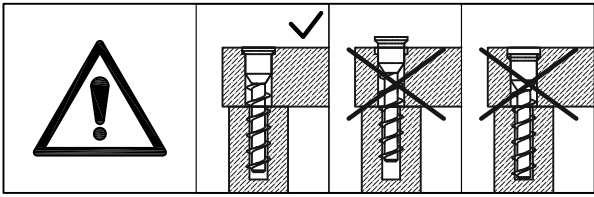
B x 2  Ø7x50 mm	E x 1  ● 4 mm
--	--



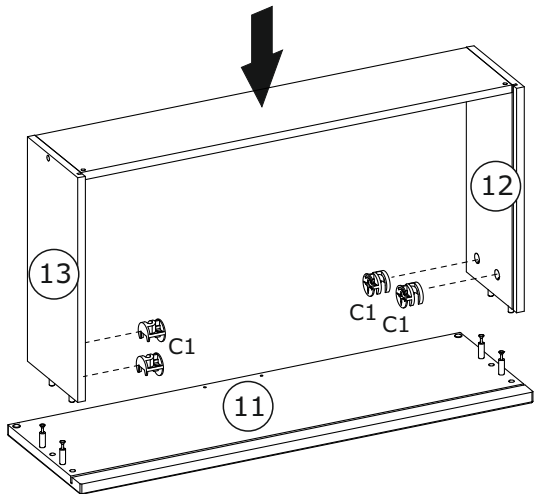
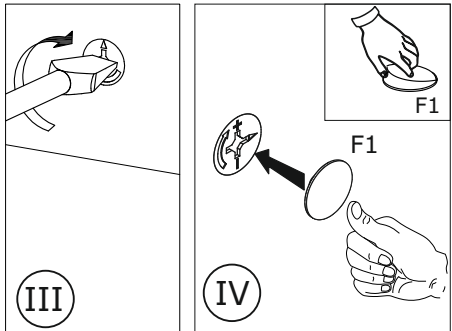
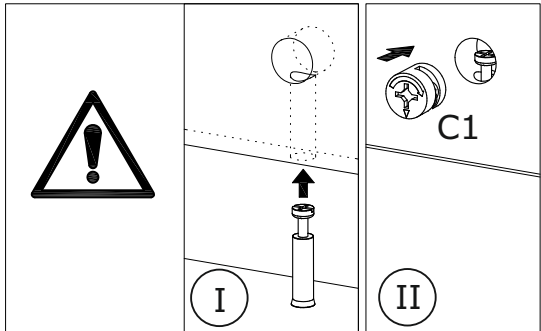
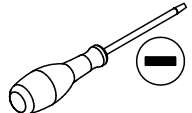

15

C1 x 4  Ø15x10 mm	F1 x 4  20 mm
--	--

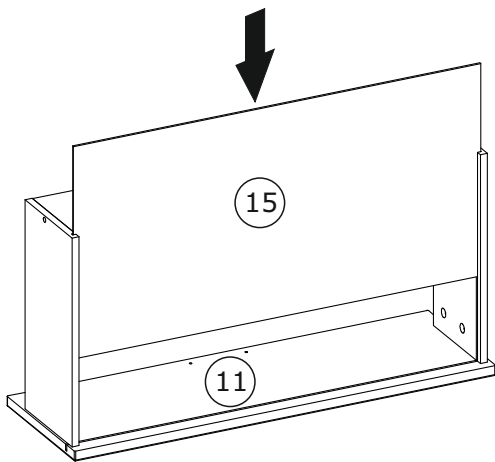

16



  $XX = YY \equiv 90^\circ$

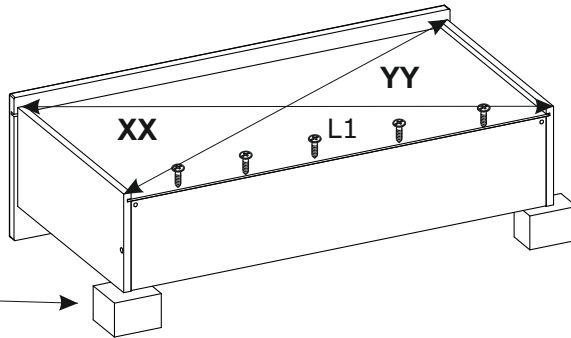
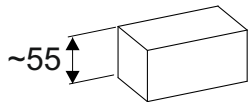
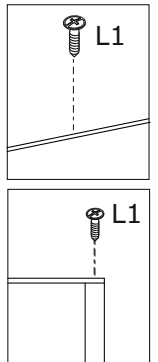

17

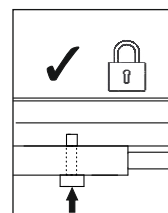
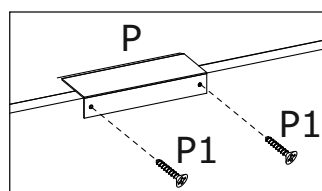
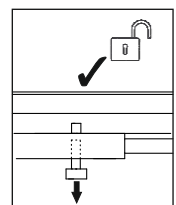
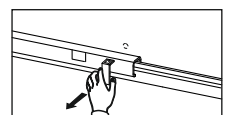
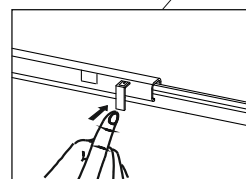
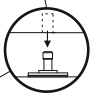
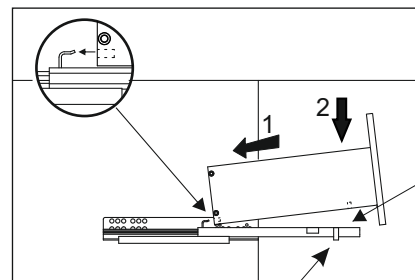
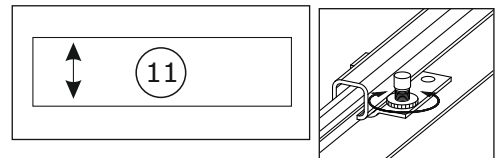
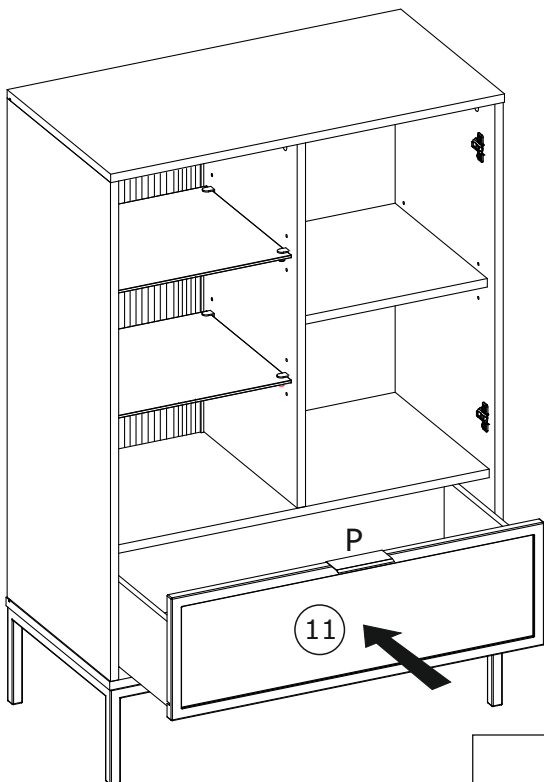

18

R6 x 2 	J1 x 4 3,5x13 mm 	S x 2 	
---	--	--	---

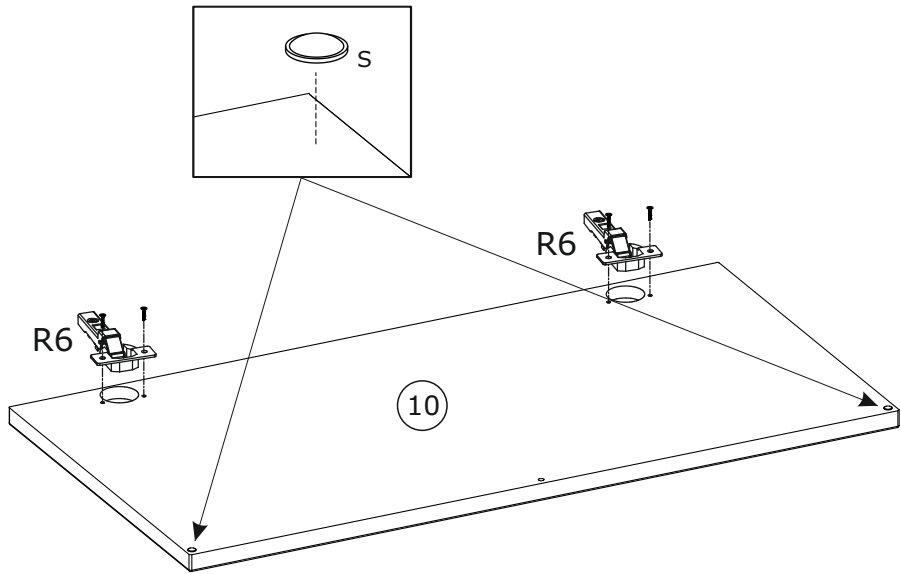
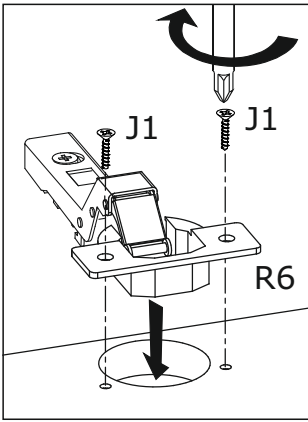

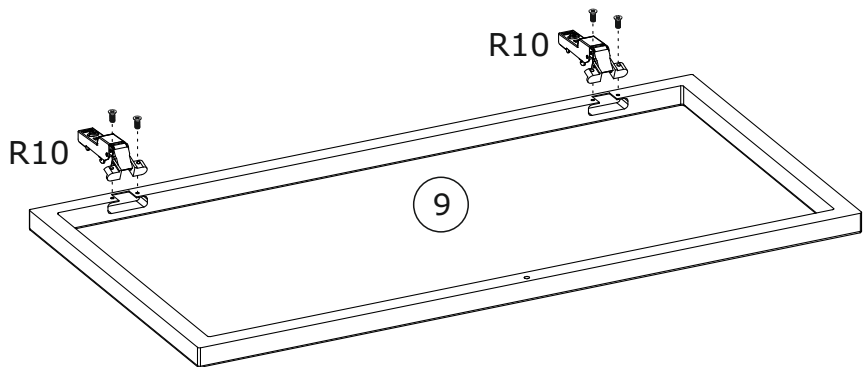
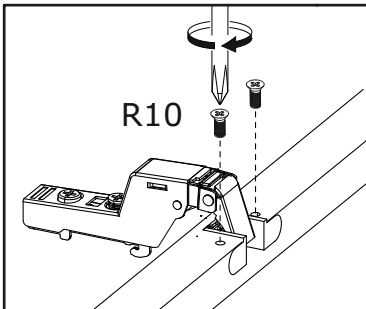
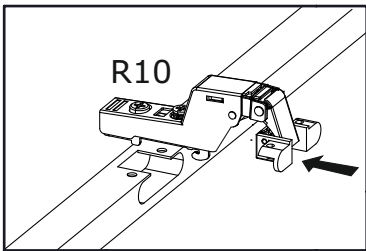

19

R10 x 2 	
--	---

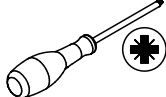

20

P2 x 2 	P3 x 1 	P4 x 1 	
---	---	---	---

