

IBIZA

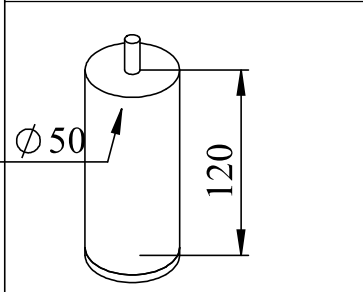

C4/C5 A x 4

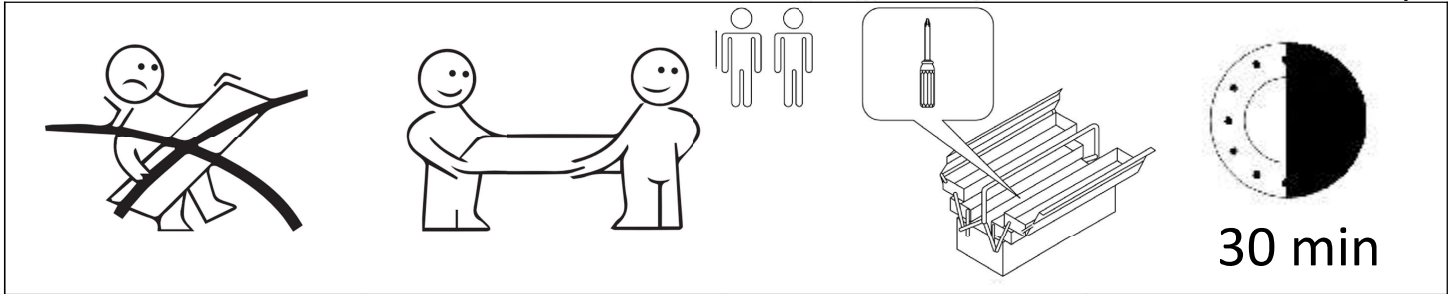
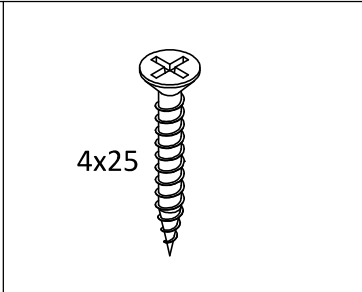

C4/C5 B x 4

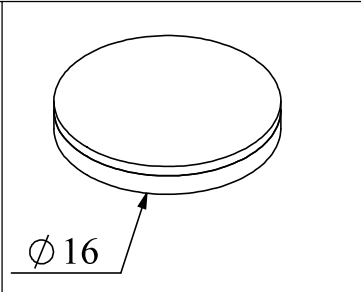

C4/C5 C x 2

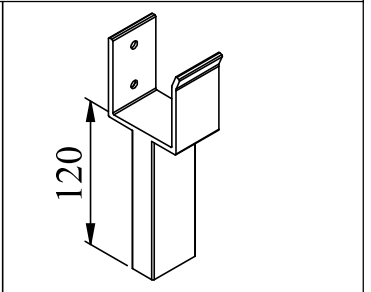

C4/C5 D x 2

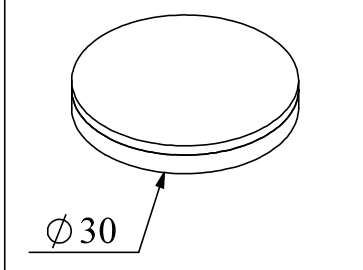

C4/C5 Ex6

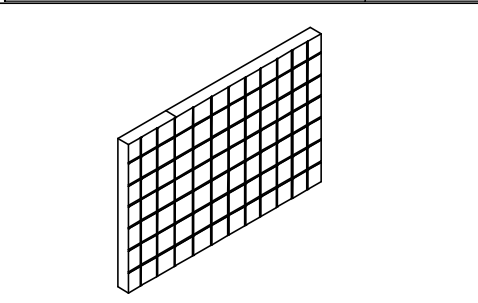

C1/ 1 x 1

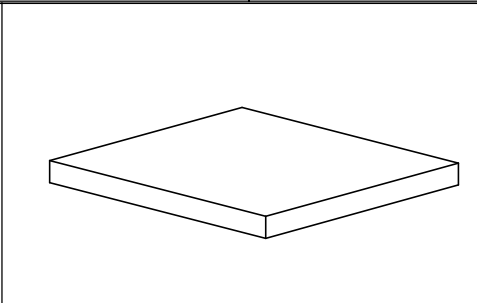

C2/ 2 x 1

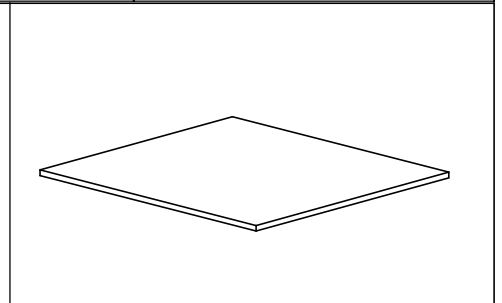

C3/ 3 x 1

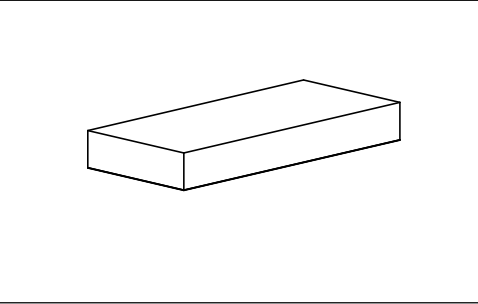

C4/C5 4 x 2

