

Brizzini

Kurzanleitung
Quick Guide
Guide rapide
Snelle handleiding
Guida rapida
Szybki przewodnik

Краткое руководство
Ghid rapid
Stručný sprievodca
Stručný průvodce
Gyors útmutató
Hızlı rehber

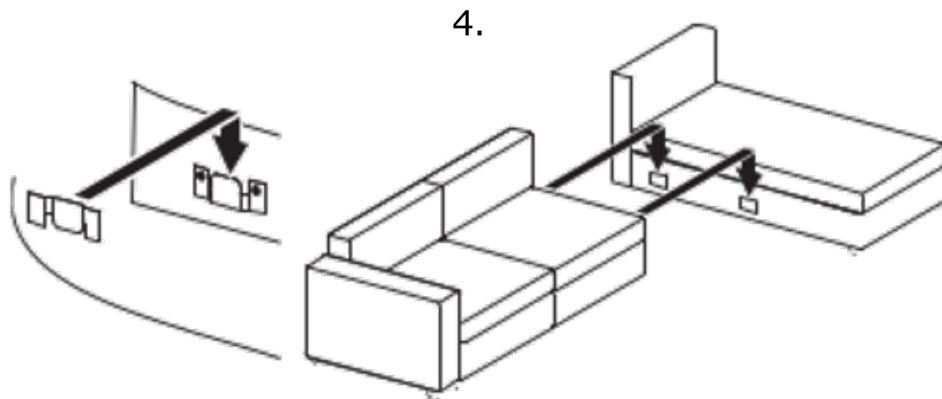



A	3x	
B	3x	
C	3x	
D	2x	
E		

	<p>1.</p>	<p>2.</p>	<p>3.</p>



 Nicht waschen / Do not wash / Ne pas laver / Niet wassen / Non lavare / Nie prać / Не стирать / Nu se spală / Neumývajte / Neumývejte / Ne mossuk / Yıkamayın

 Nicht bleichen / Do not bleach / Ne pas blanchir / Niet bleken / Non candeggiare / Nie wybielać / Не отбеливать / Nu înălbiți / Nebielit' / Nebělít / Ne fehérsít / Ağartmayın

 Nicht im Wäschetrockner trocknen / Do not tumble dry / Ne pas sécher en sèche-linge / Niet in de droger drogen / Non asciugare in asciugatrice / Nie suszyć w suszarce bębnowej / Не сушить в барабане / Nu se usucă cu tambur / Nesušit' v bubnovej sušičke / Nesušit' v sušičce / Ne szárítsuk szárítógépben / Çamaşır makinesinde kurutmayın

 Nicht bügeln / Do not iron / Ne pas repasser / Niet strijken / Non stirare / Nie prasować / Не гладить / Nu se calcă / Nežehlit' / Ne vasaljon / Ütü yapmayın

 Nicht für die chemische Reinigung geeignet (Nicht trockenreinigen) / Not suitable for dry cleaning / Ne convient pas au nettoyage à sec / Niet geschikt voor stomerij / Non adatto al lavaggio a secco / Nie nadaje się do czyszczenia chemicznego / Не подходит для химчистки / Nu se curăță pe uscat / Nevhodné na chemické čistenie / Nevhodné pro chemické čištění / Százaz tisztításra nem alkalmas / Kuru temizleme için uygun değildir

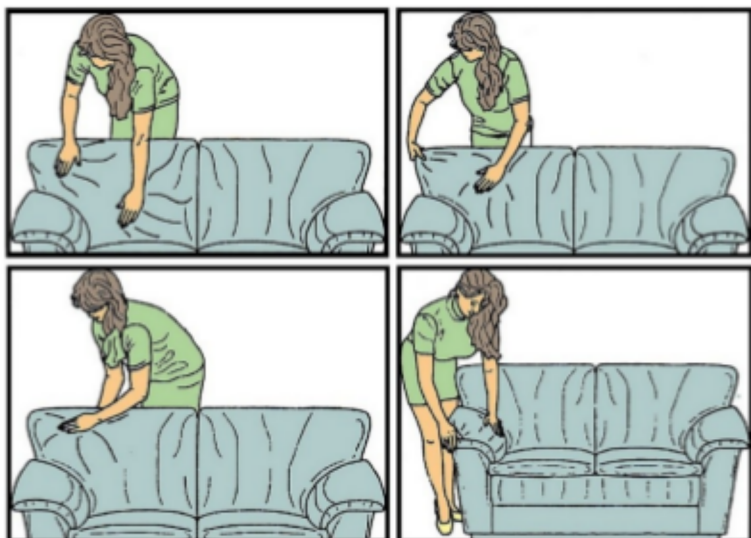

24 h

