

# ROOF 70-969-\_\_-6

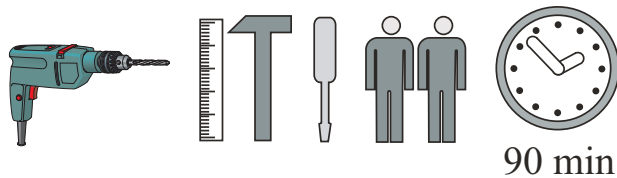

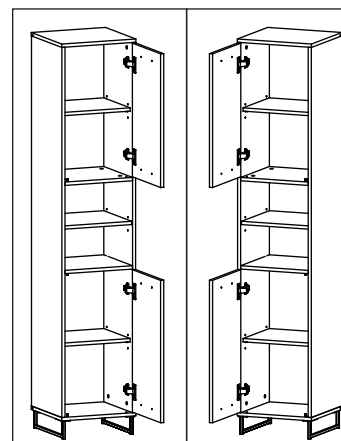
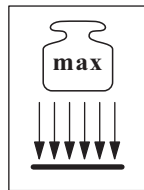
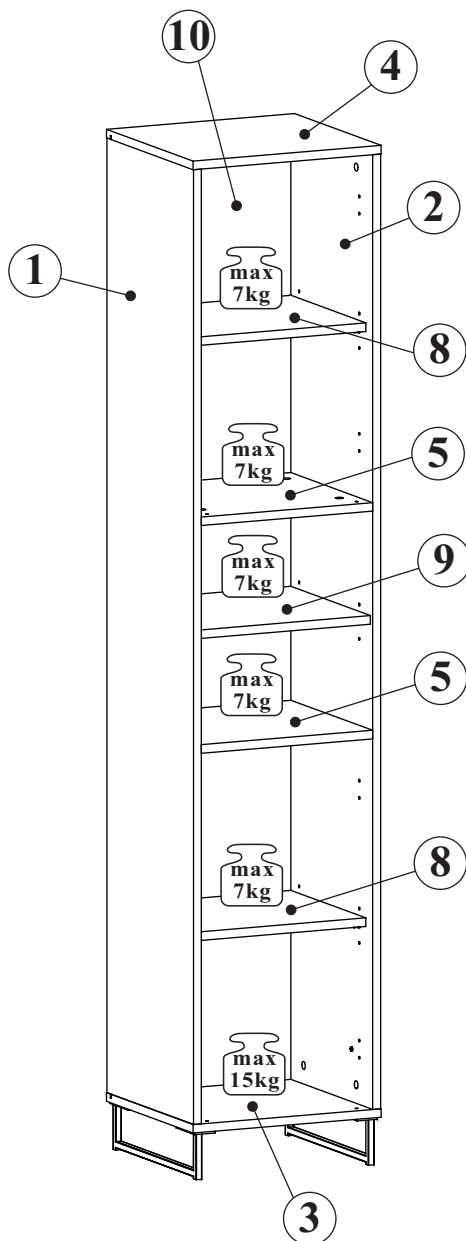
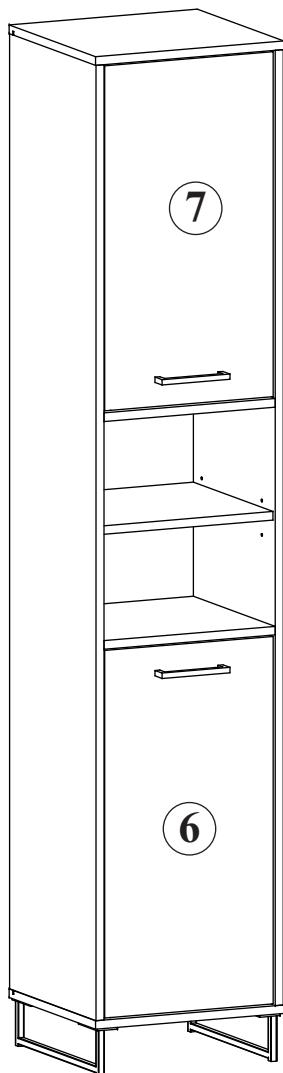
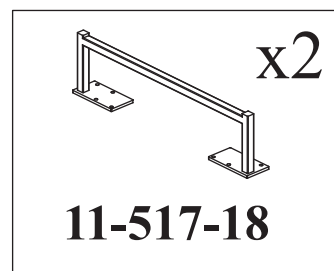

90 min

NO	Dim.			Col.-No	Qty
1	1778	368	16	1	1
2	1778	368	16	1	1
3	382	368	16	1	1
4	382	368	16	1	1
5	348	348	16	1	2
6	342	684	16	1	1
7	342	642	16	1	1
8	348	319	16	1	2
9	348	338	16	1	1
10	1790	360	3	1	1

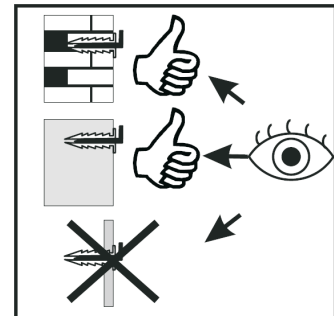
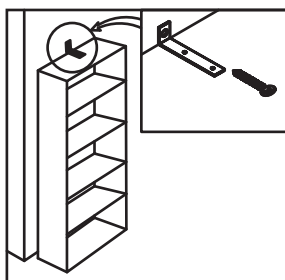
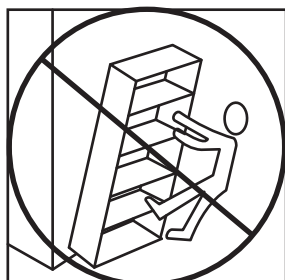
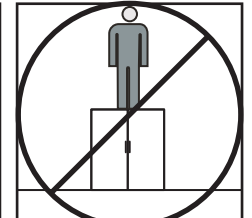
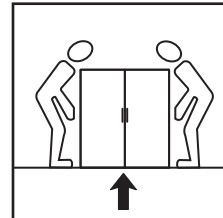
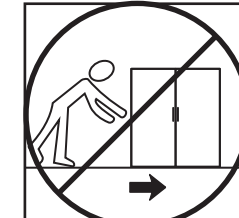
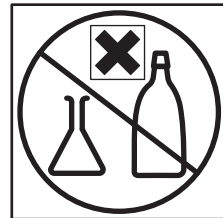
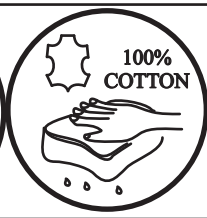
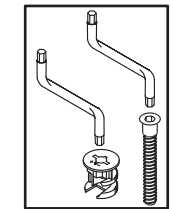
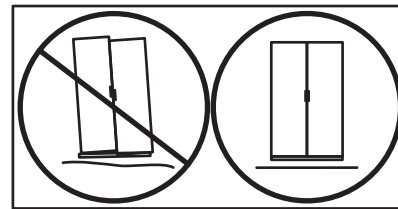
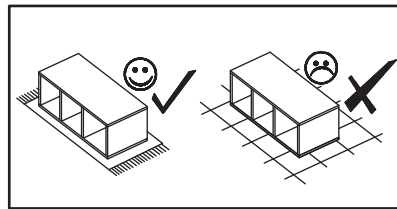
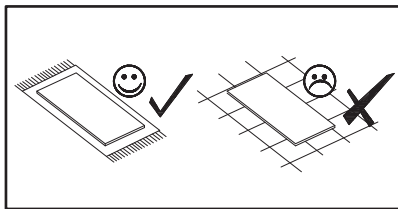
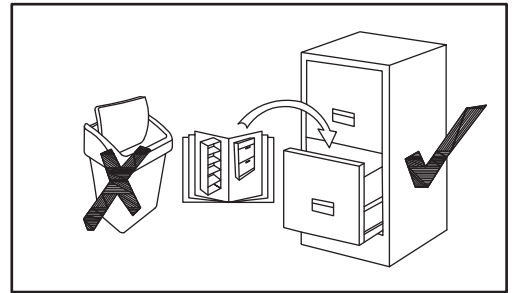
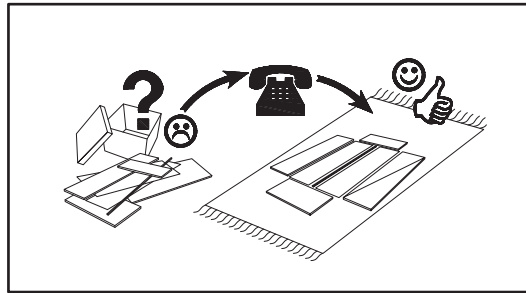
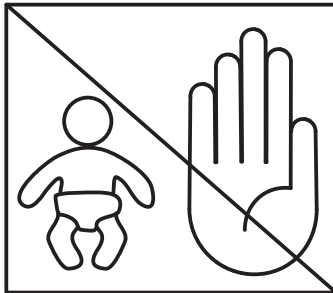
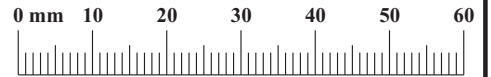

A1 x16 ø8x36	B4 x16	B5 x16 ø15x12	G5 x16	G7 x11	G20 x4
E25 x4 Ø35 H=16	E4 x4 H=2	D10 x11 USØ3,5x13	Z2 x16 Ø5	U17 x2 L-128mm.	UP6 x4 UPØ4x30
S1 x14	UP13 x6 UPØ3x16	UP5 x16 UPØ4x16	KR1 x1	L1 x1	G2 x1
PH x1					

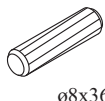
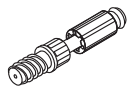

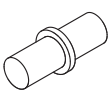
A1 x8	 ø8x36	B4 x8		B5 x8	 ø15x12
PH x1		G7 x11			

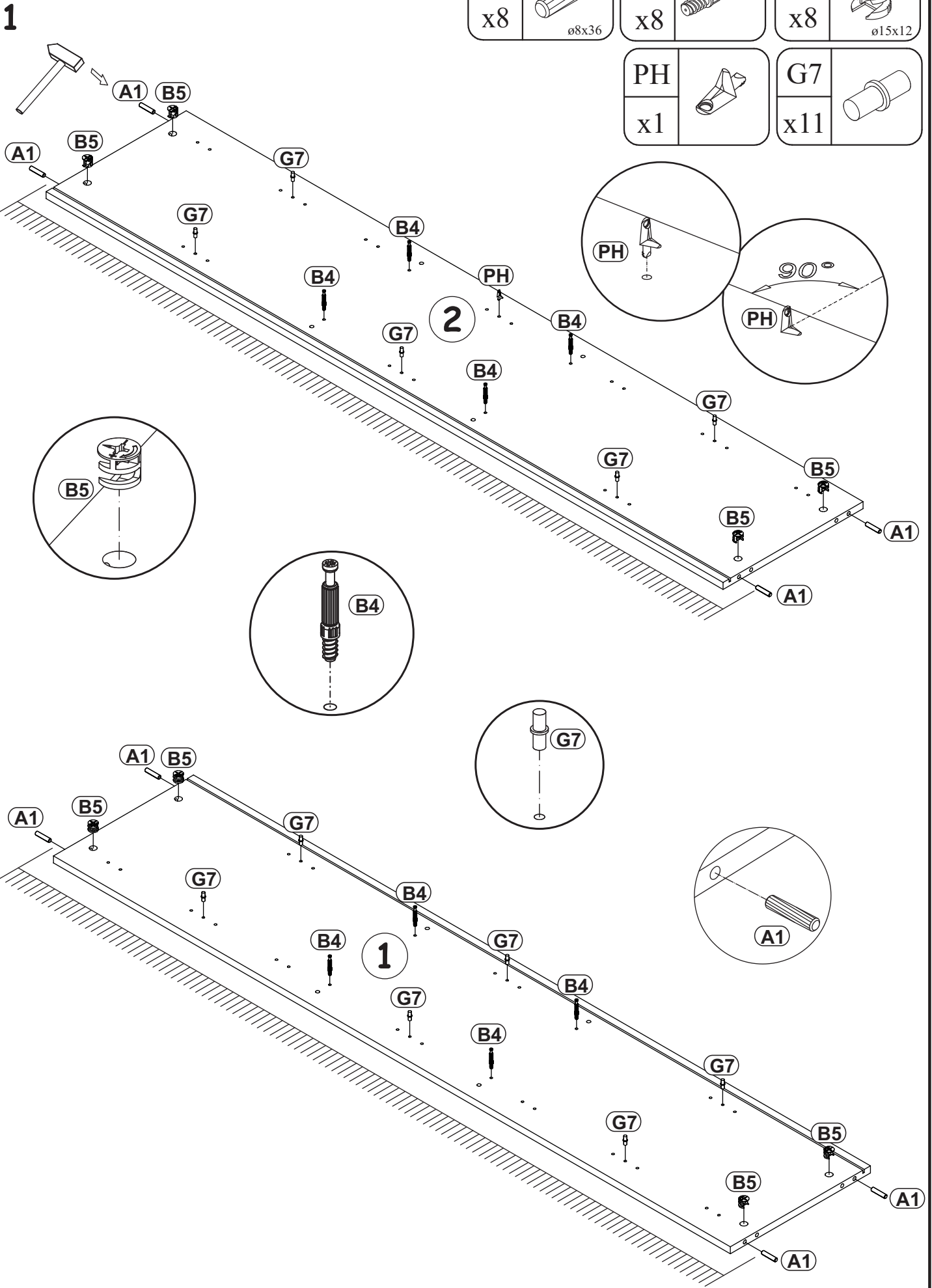

2

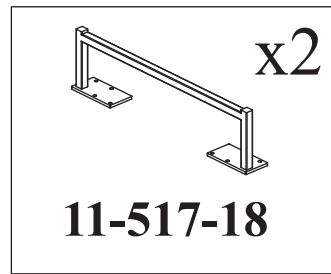
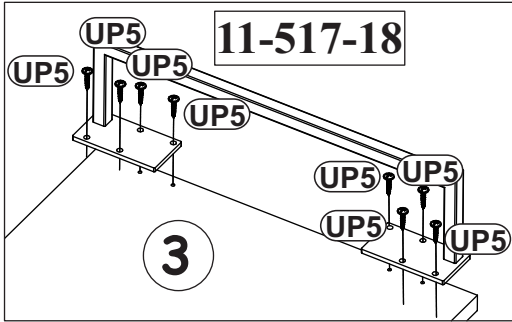

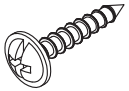
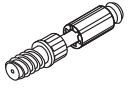
UP5	
x16	UPØ4x16
B4	
x4	

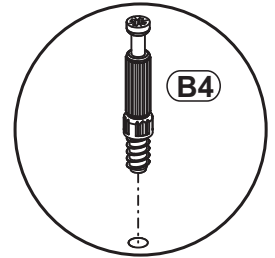
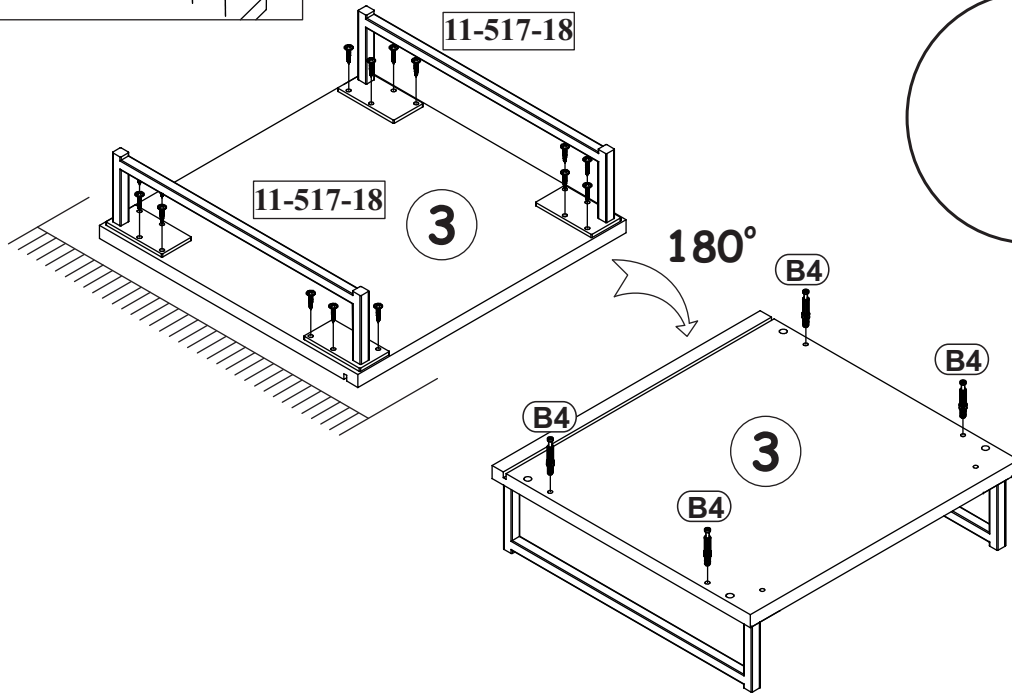

3

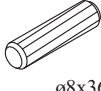
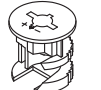
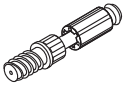
A1		B5		B4	
x8	ø8x36	x8	ø15x12	x4	

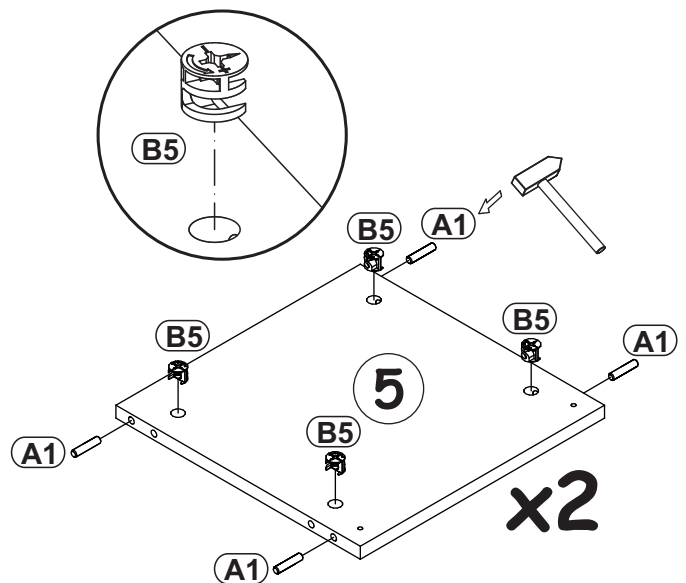
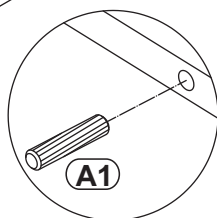
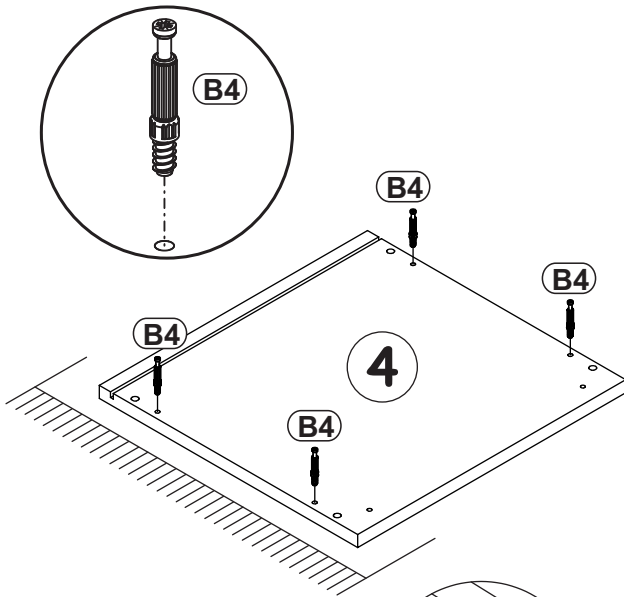

4

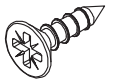
E25	Ø35	D10	 USØ3,5x13
x4	H=16	x8	

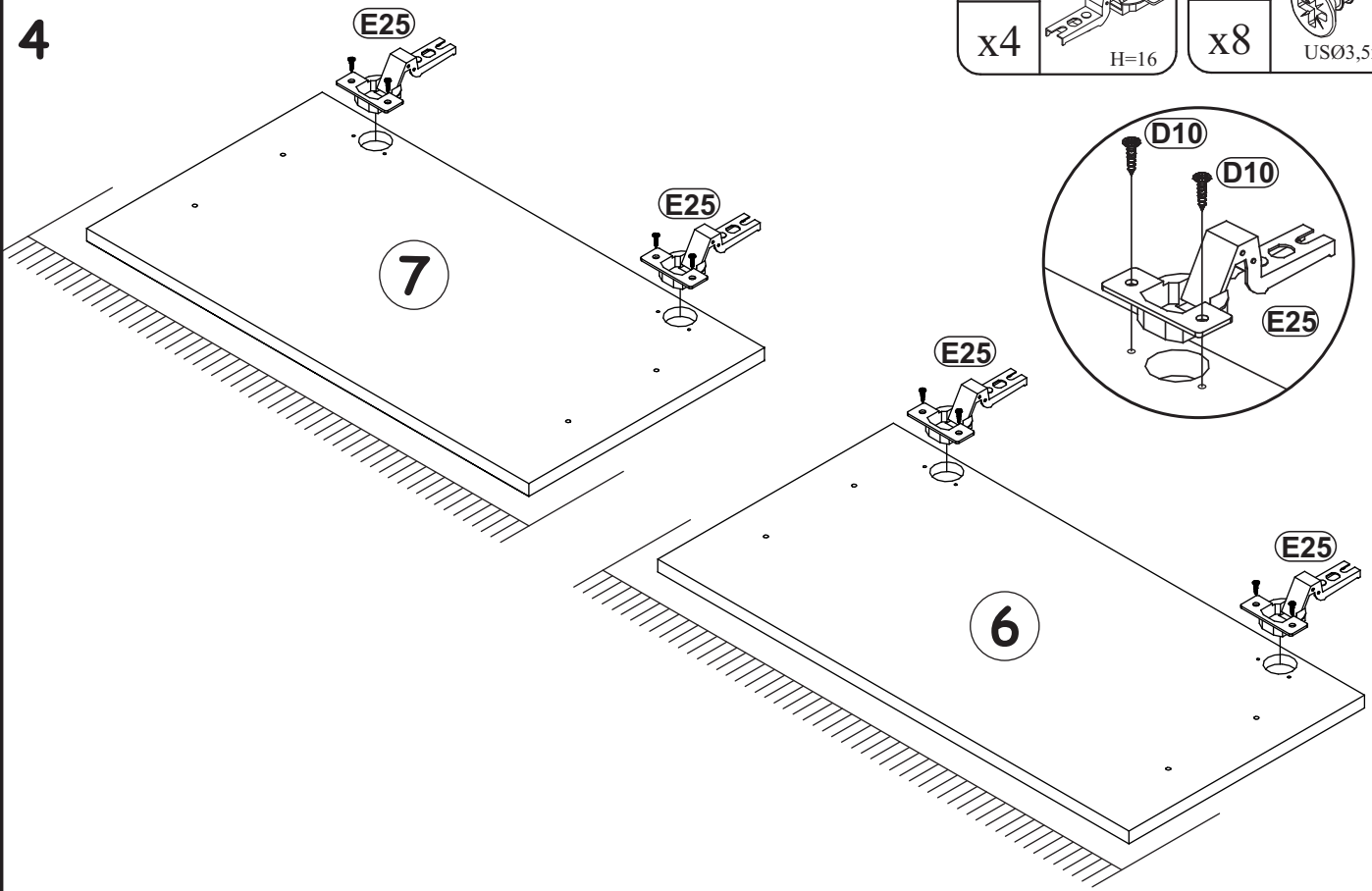

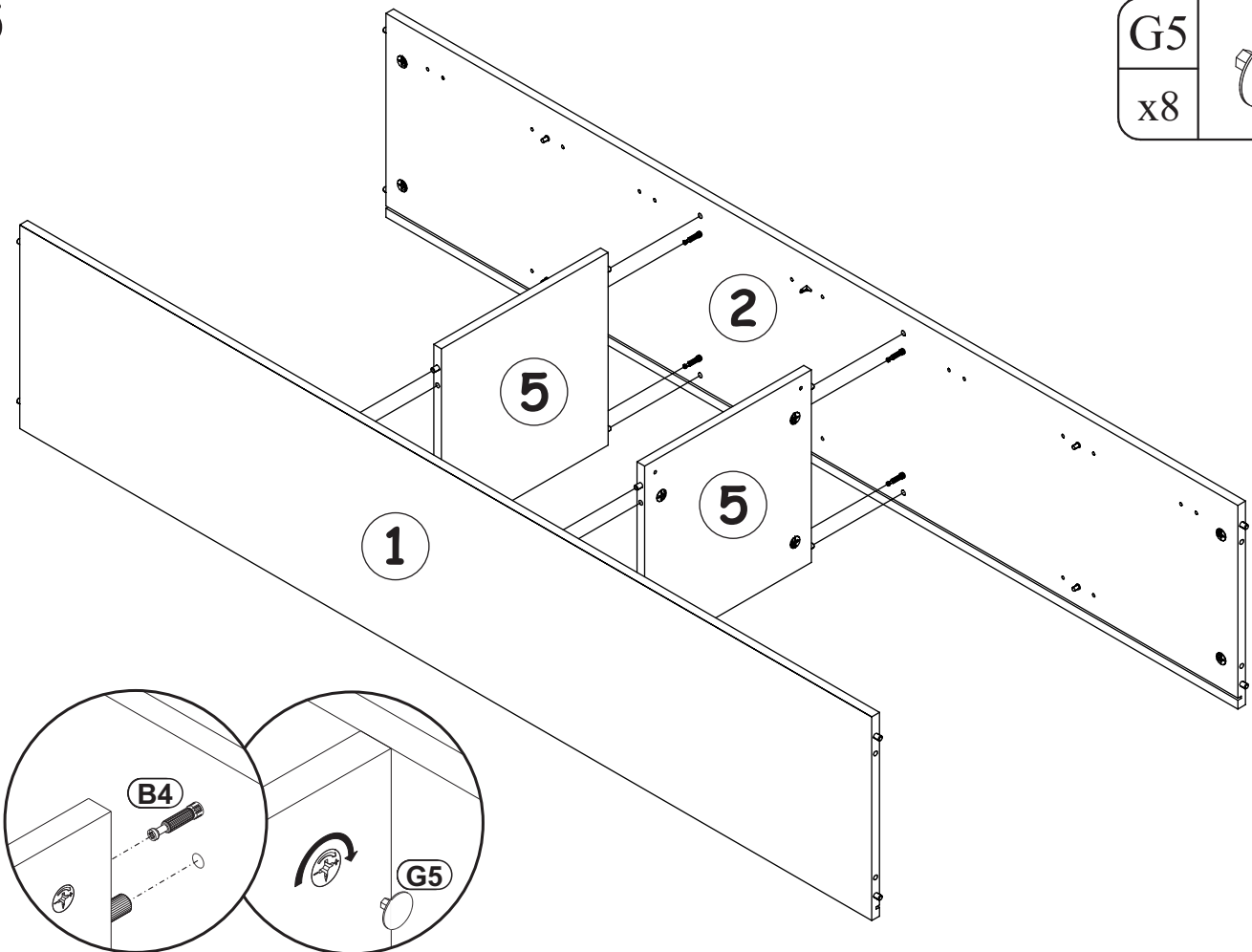

5

G5	
x8	

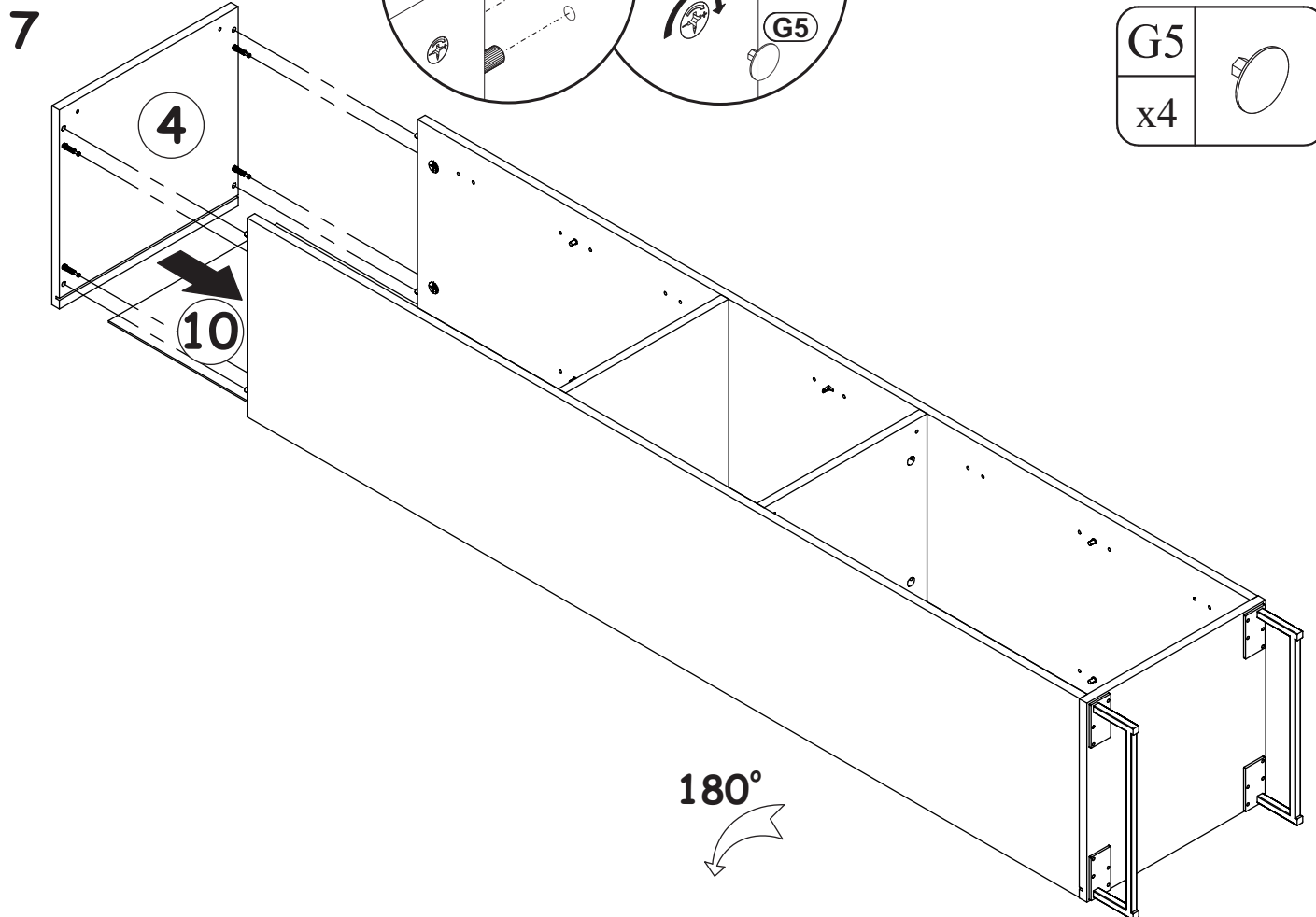
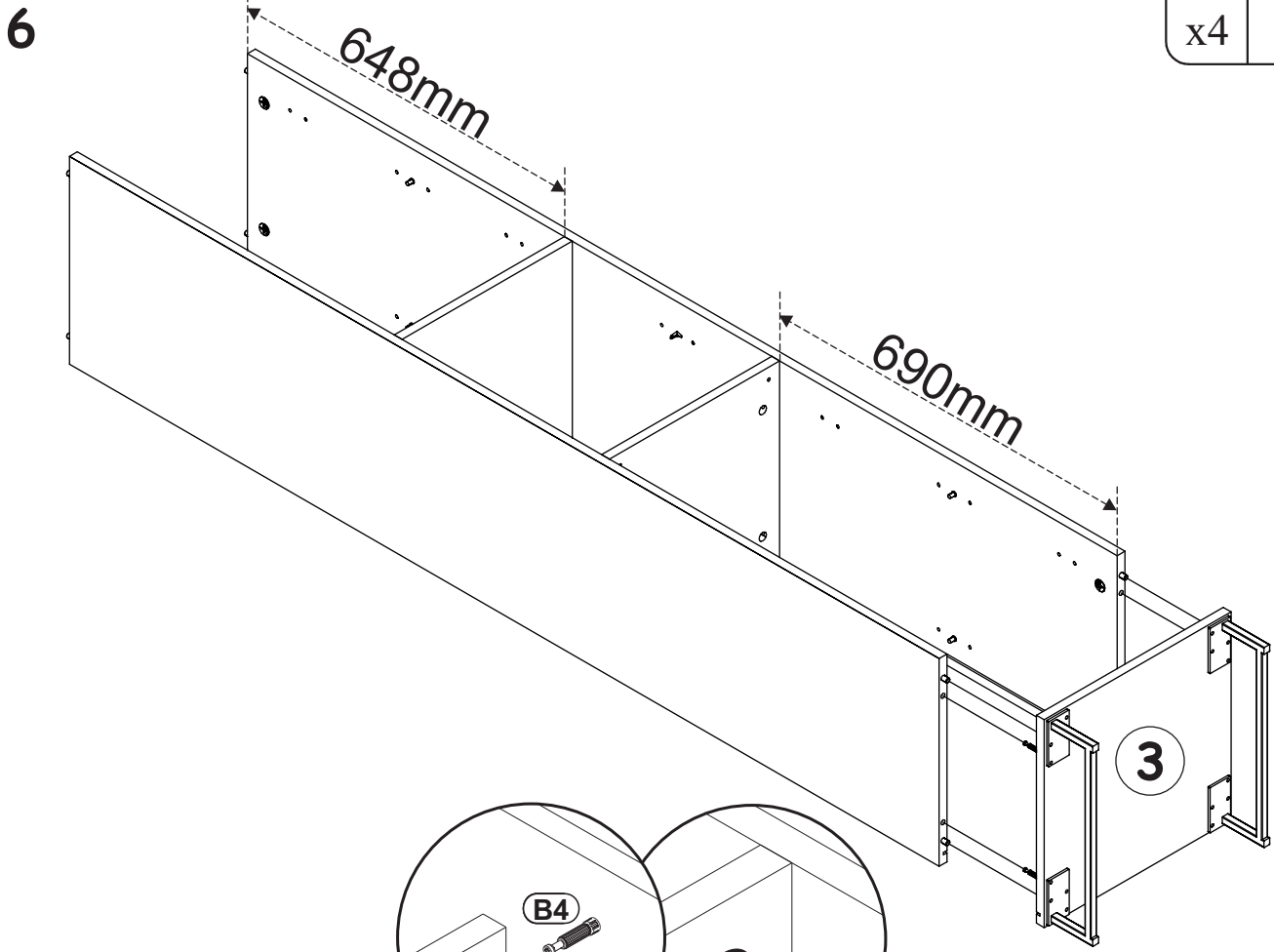

G5	
x4	



G5	
x4	

8

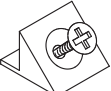
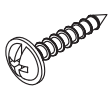
S1		UP13	
x14		x6	UPØ3x16

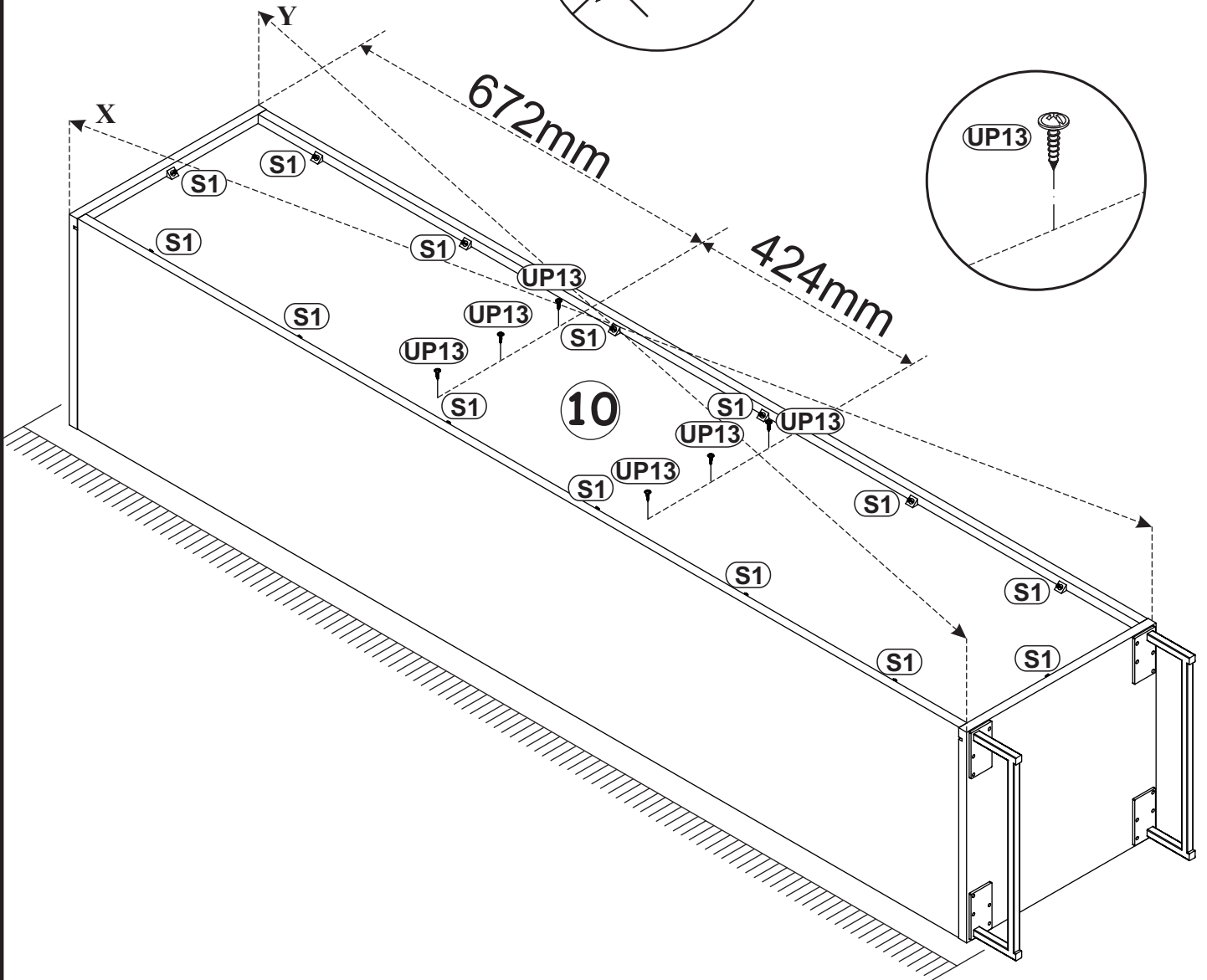
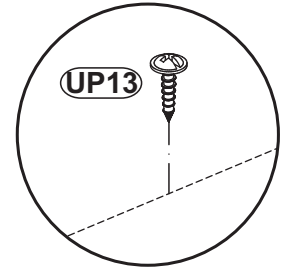
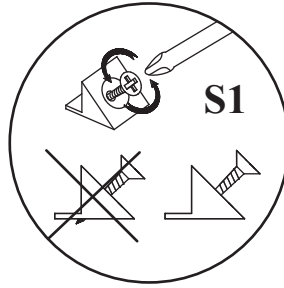

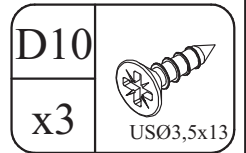
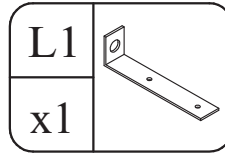
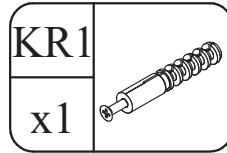

9

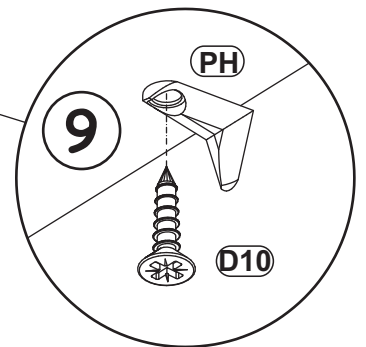
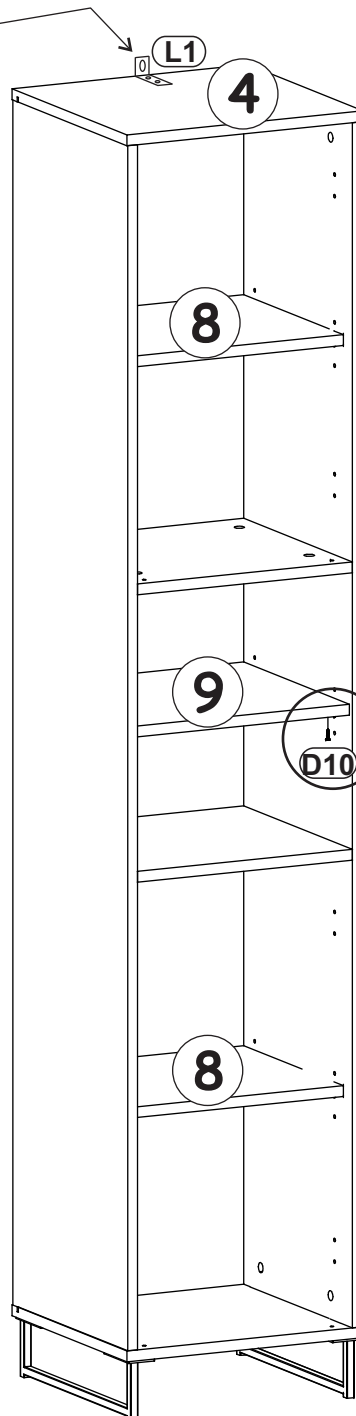
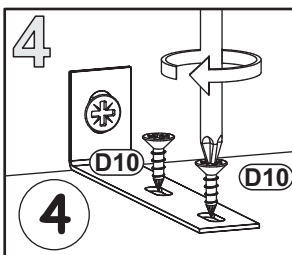
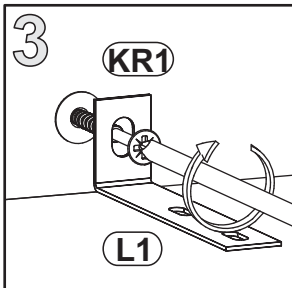
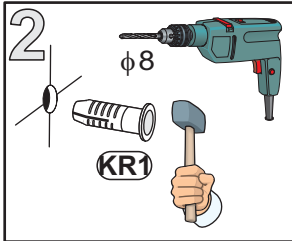
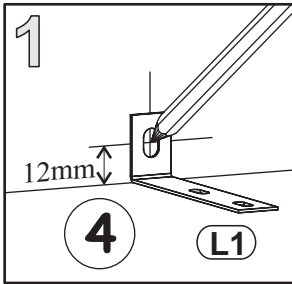
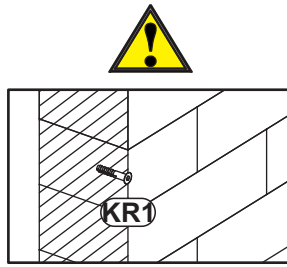
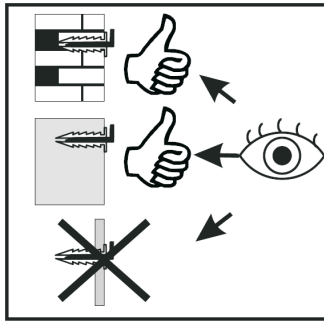



**10-13**

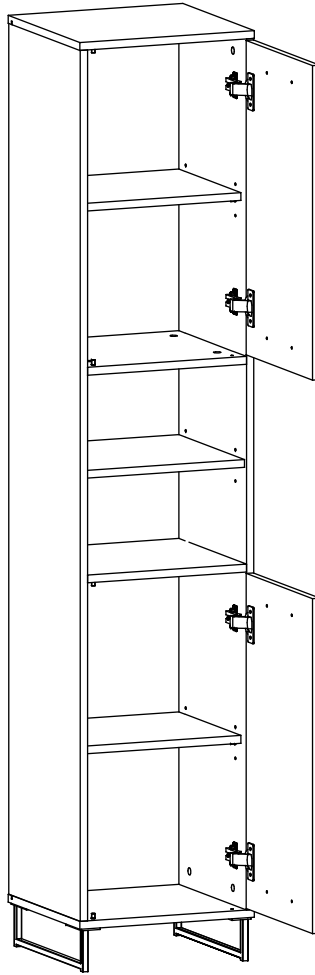

**14-17**

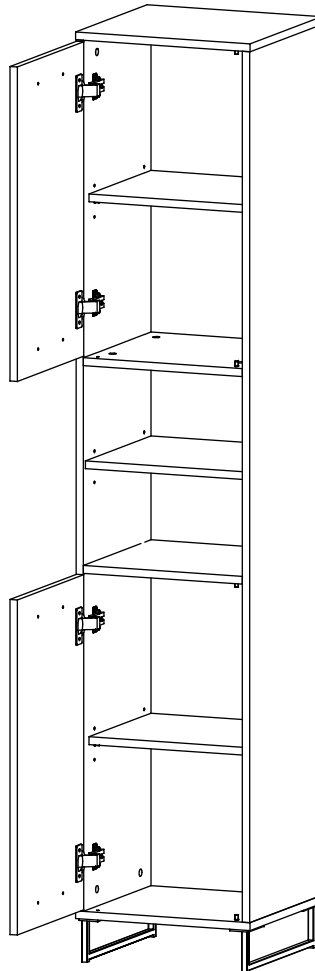

10

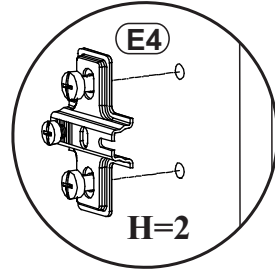
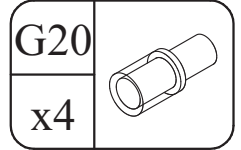
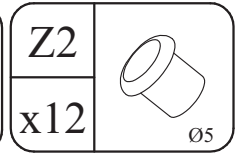
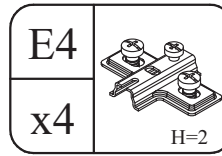
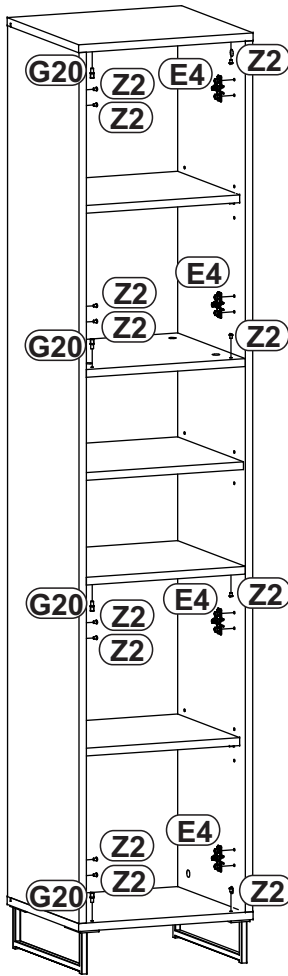
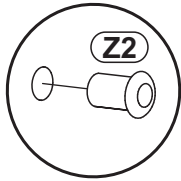
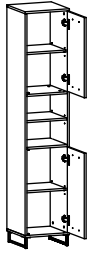

11

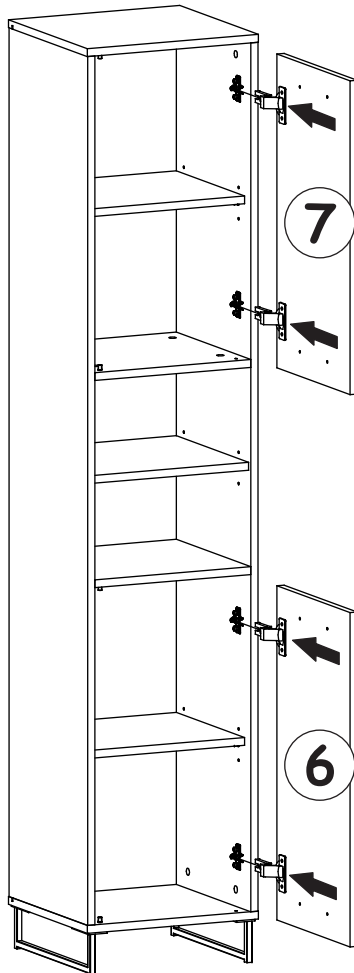
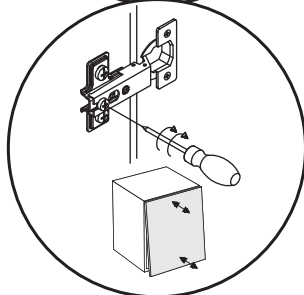
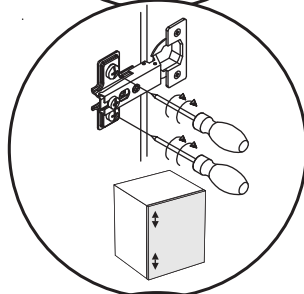
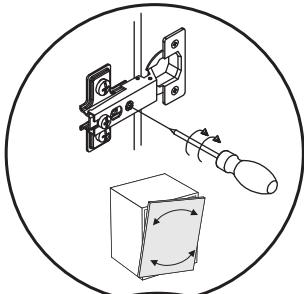

12

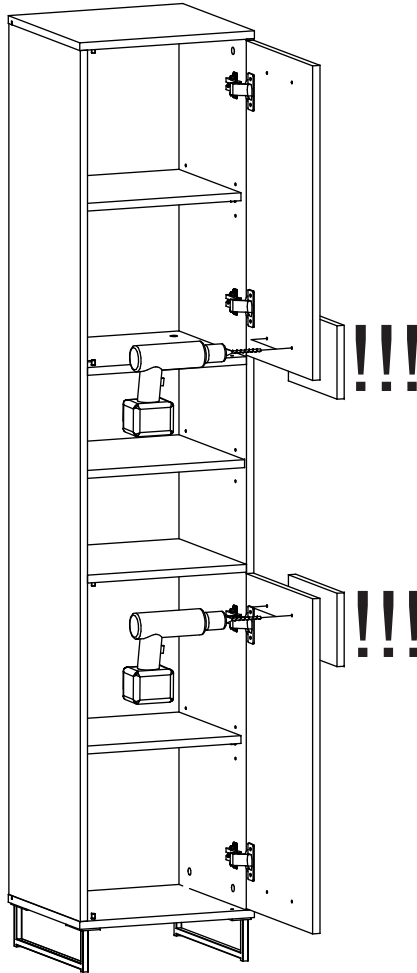
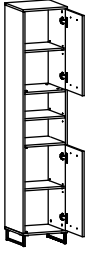

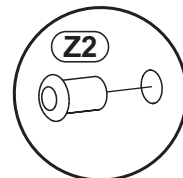
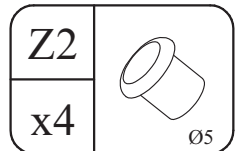
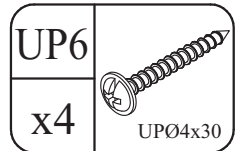
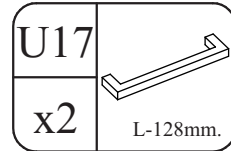
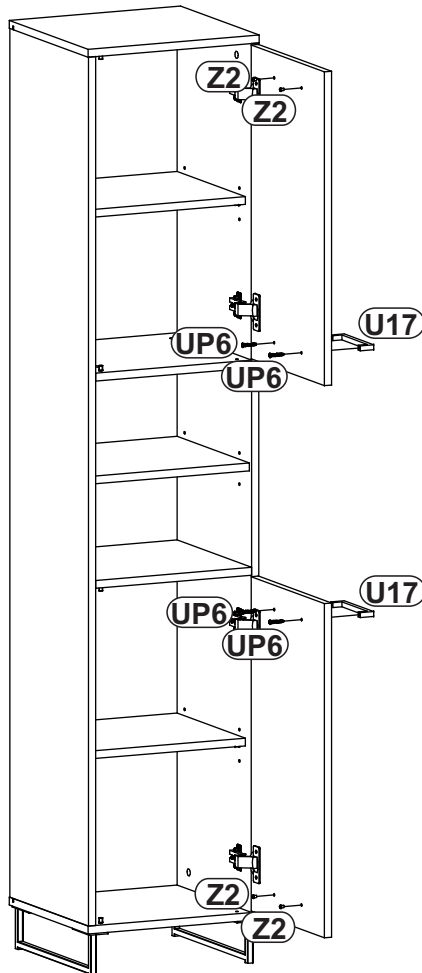

13

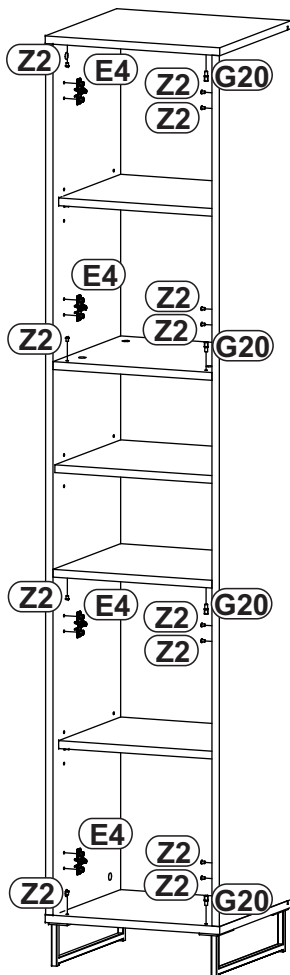
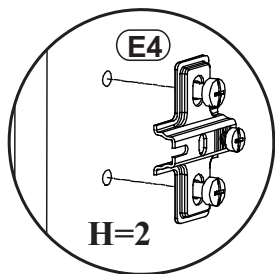

14

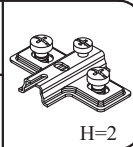

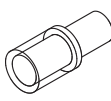
E4	 H=2	Z2	 Ø5
x4		x12	
		G20	
		x4	

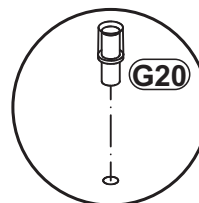
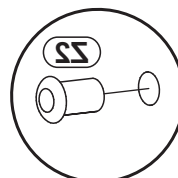

15

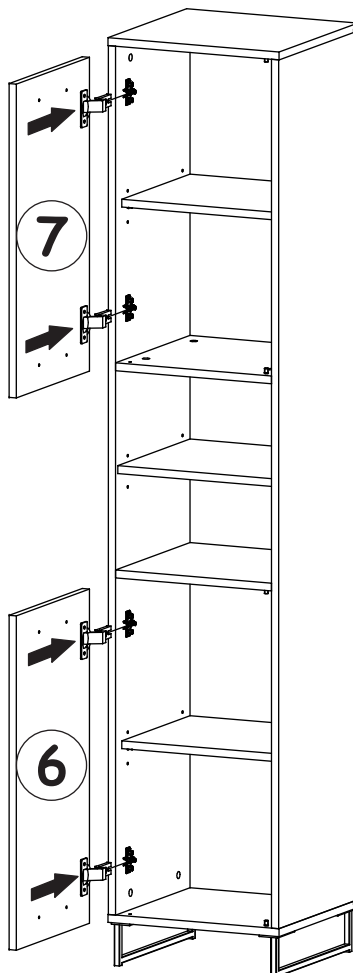
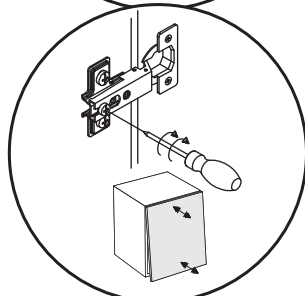
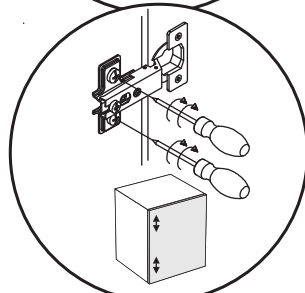
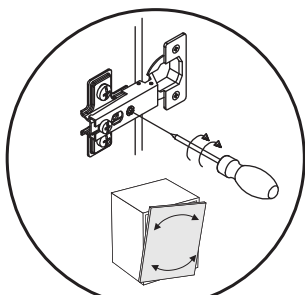

16

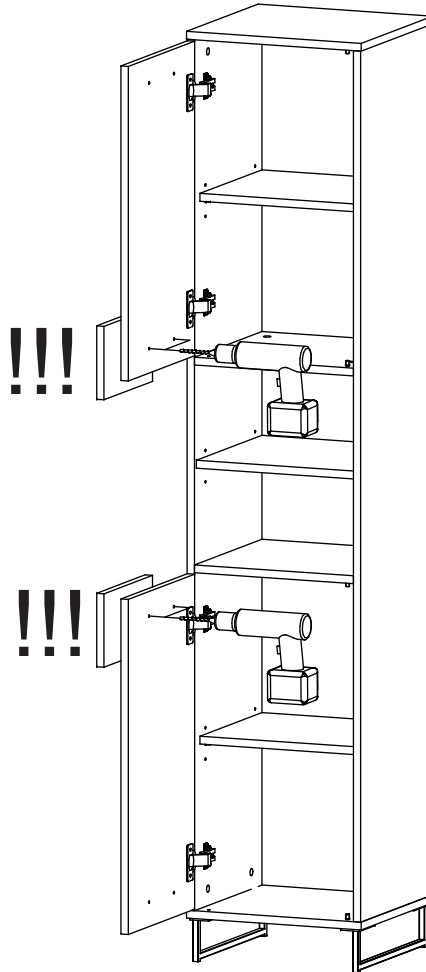
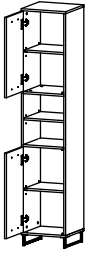

17

