

980264

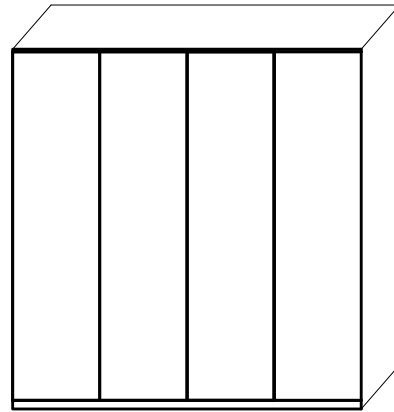

SHSP 200

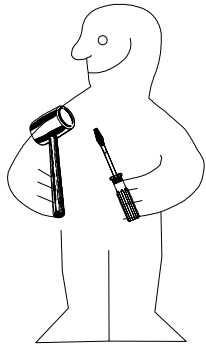
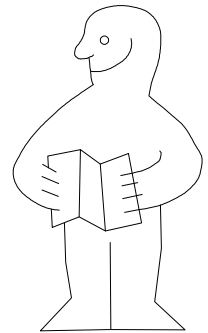
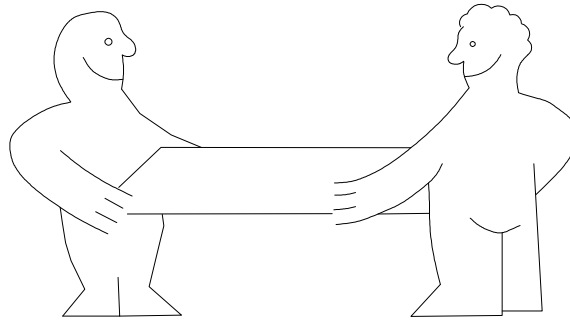
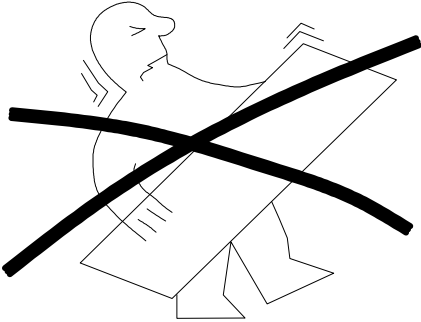

1-2-3-4... ○

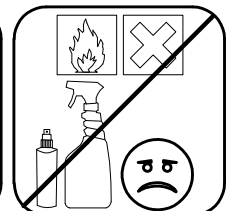
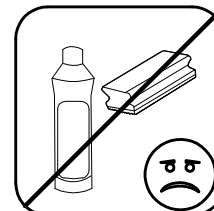
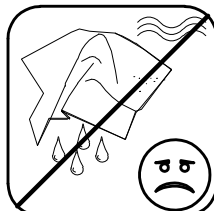
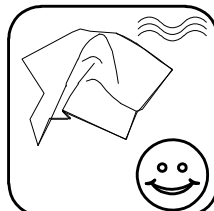
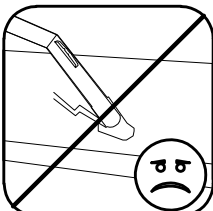
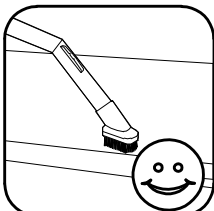
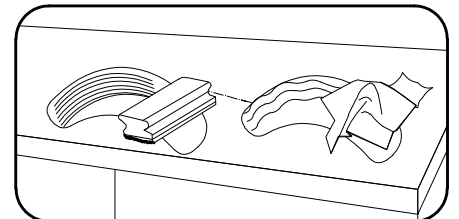
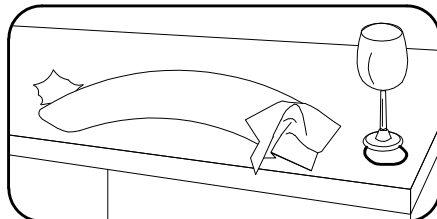
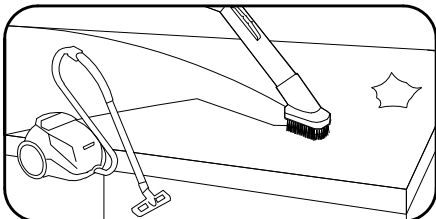
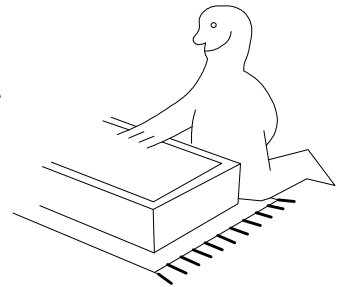
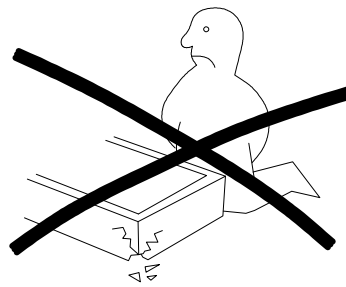
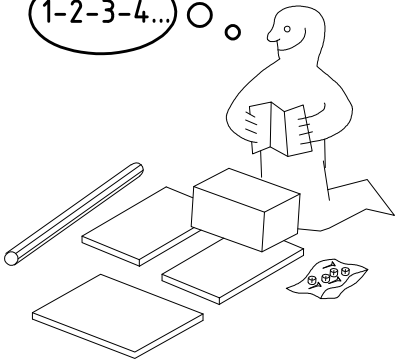







980264

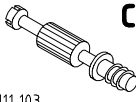



15.08.17 / 15.11.19

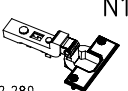

11 19



1 / 11

 111 149	A1	16x
 111 103	C	8x
 3,5 x 15 mm	F3	4x
 121 370	G1	32x

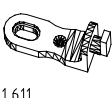
 112 291	M1	16x
 112 289	N1	16x
 111 300	S0	10x
 111 xxx	V12	10x

 117 002	K2	4x
 112 400	SBV	16x
 100cm	K10	2x
	N-D	4x

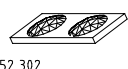
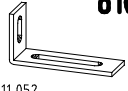
 111 611	J2	10x
 6,3 x 10,5 mm	T1	28x
 111 607	L8	16x

 352 302	KP8	8x
 111 052	o10	1x
 121 120	SP15	3x

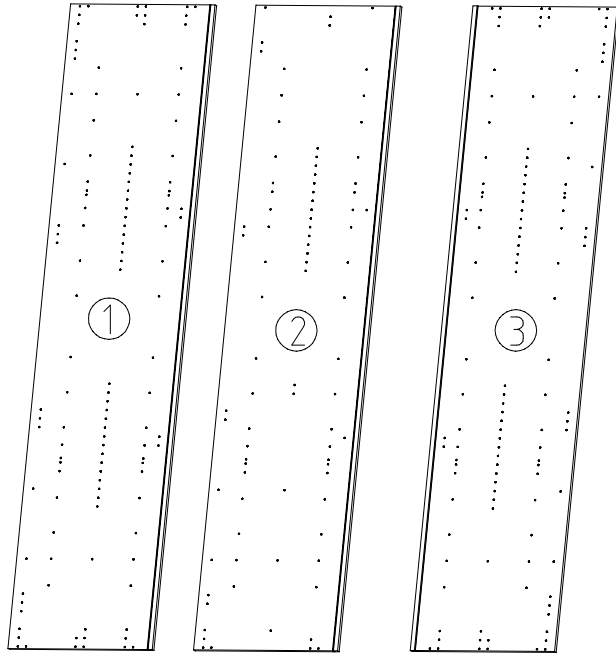
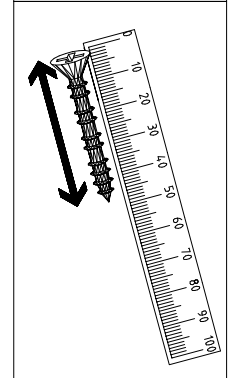
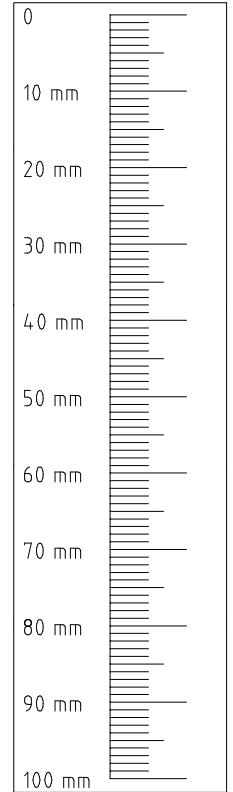
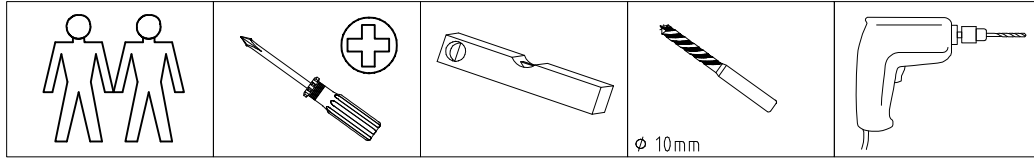

2352x560x15

2352x560x15

2352x560x15

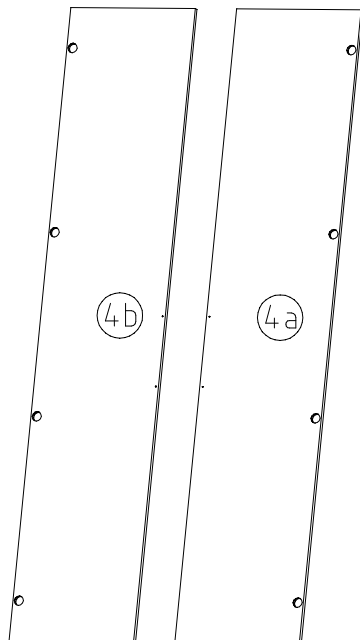

2310x484x15  
2x

2310x484x15  
2x

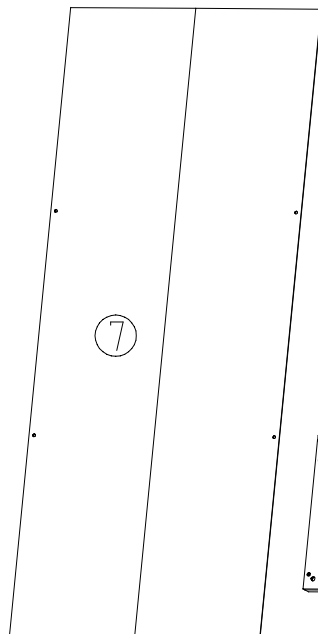

2x 2303x973x2,5

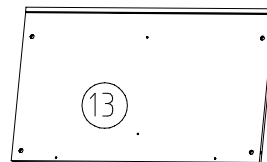

2x 964x560x15

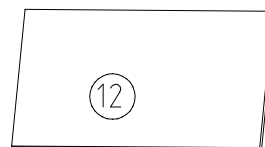

4x 964x500x18

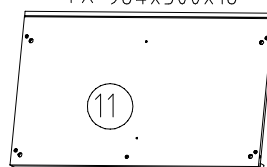

2x 964x560x47

1

3,5 x 15 mm

G1

S0

A1



121 370

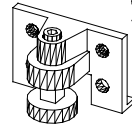

111 300

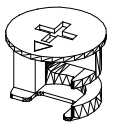

111 149

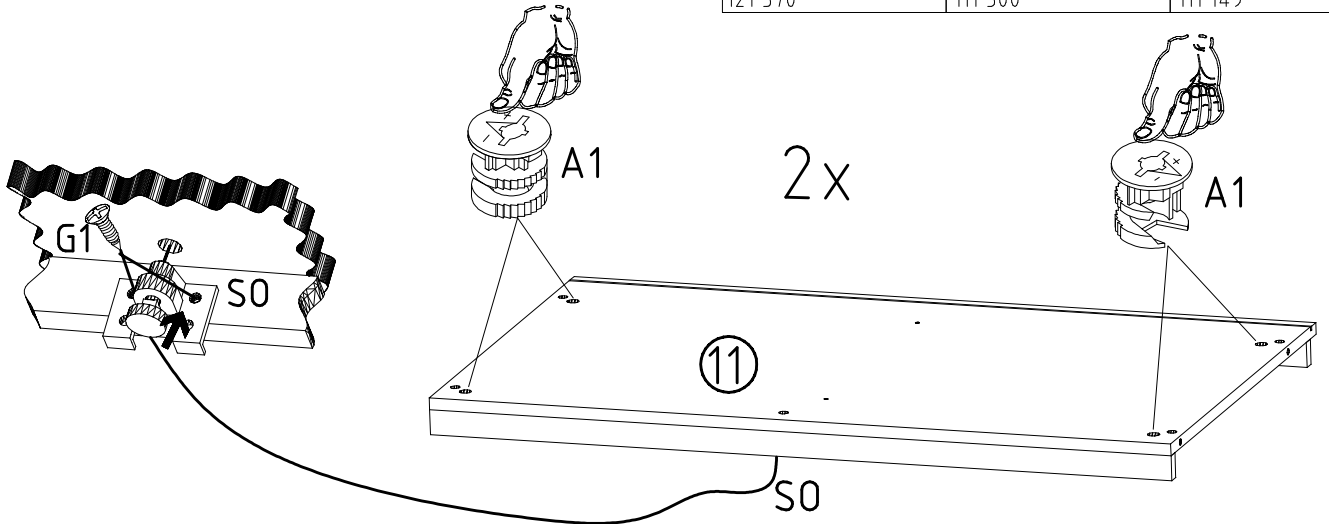

2

A1

111 149

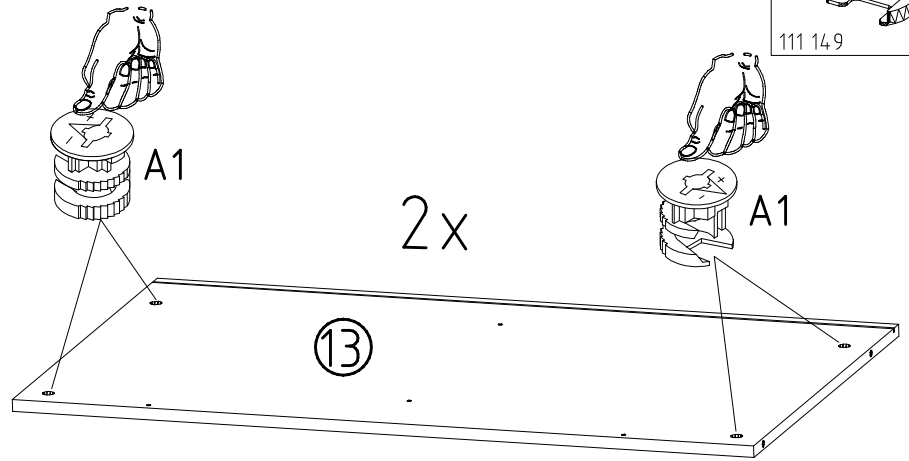

3

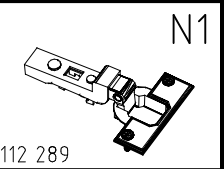
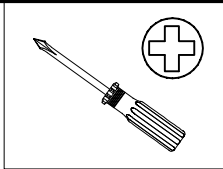
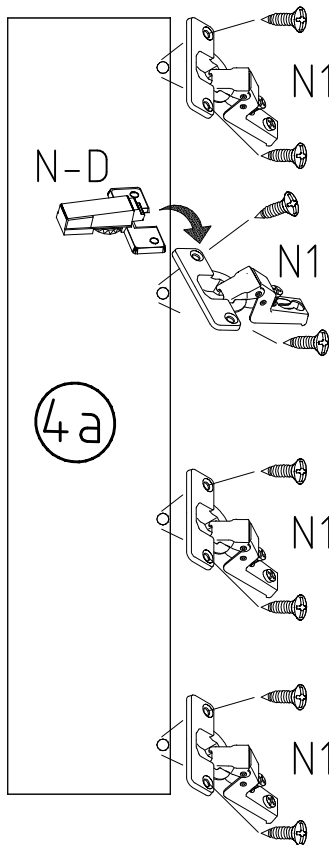
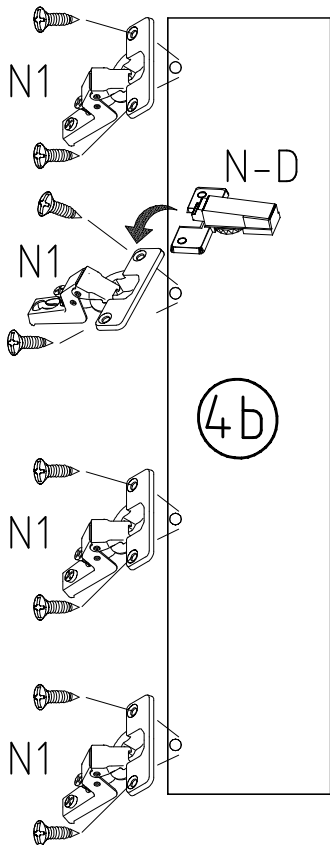

112 289

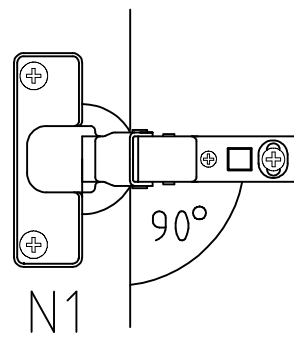
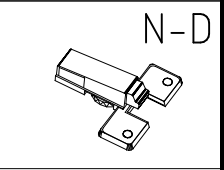





6

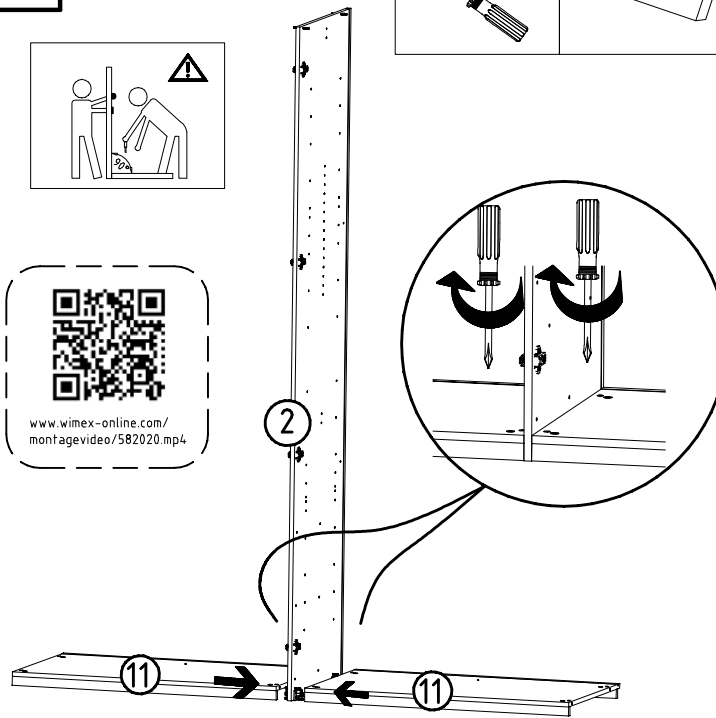

7

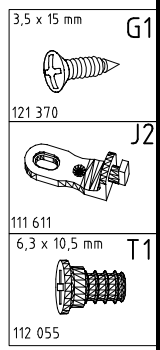
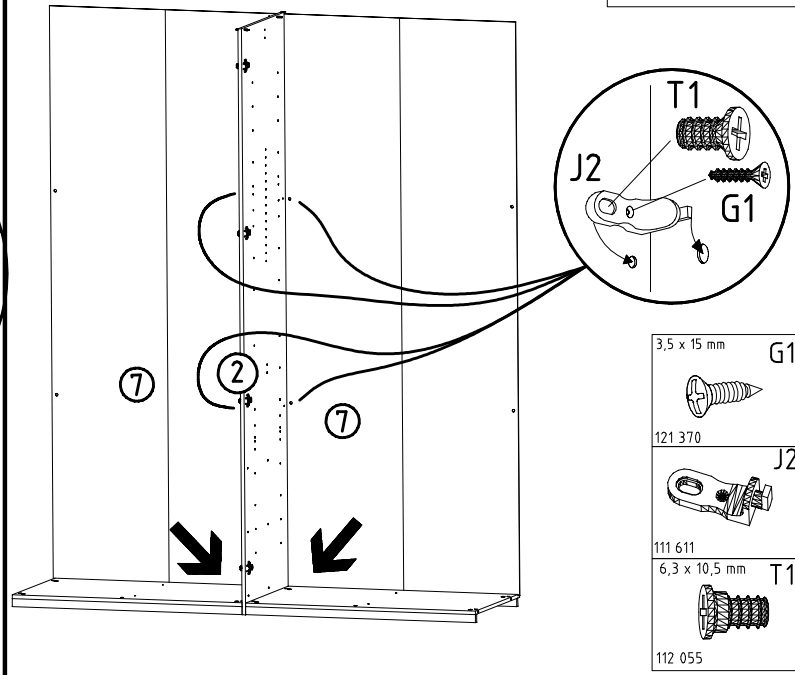

8

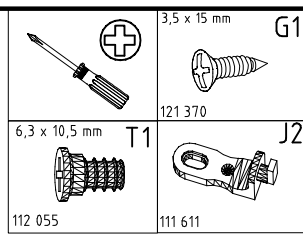
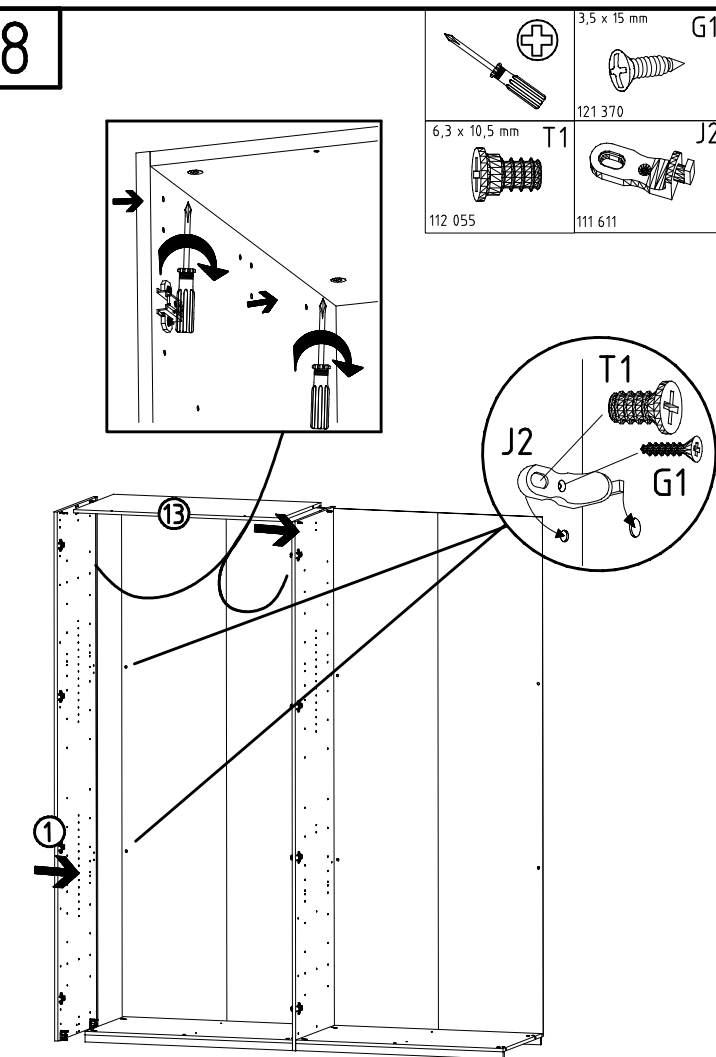

9

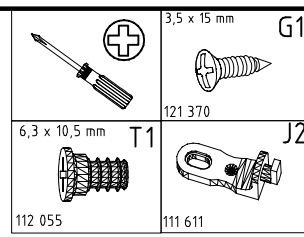
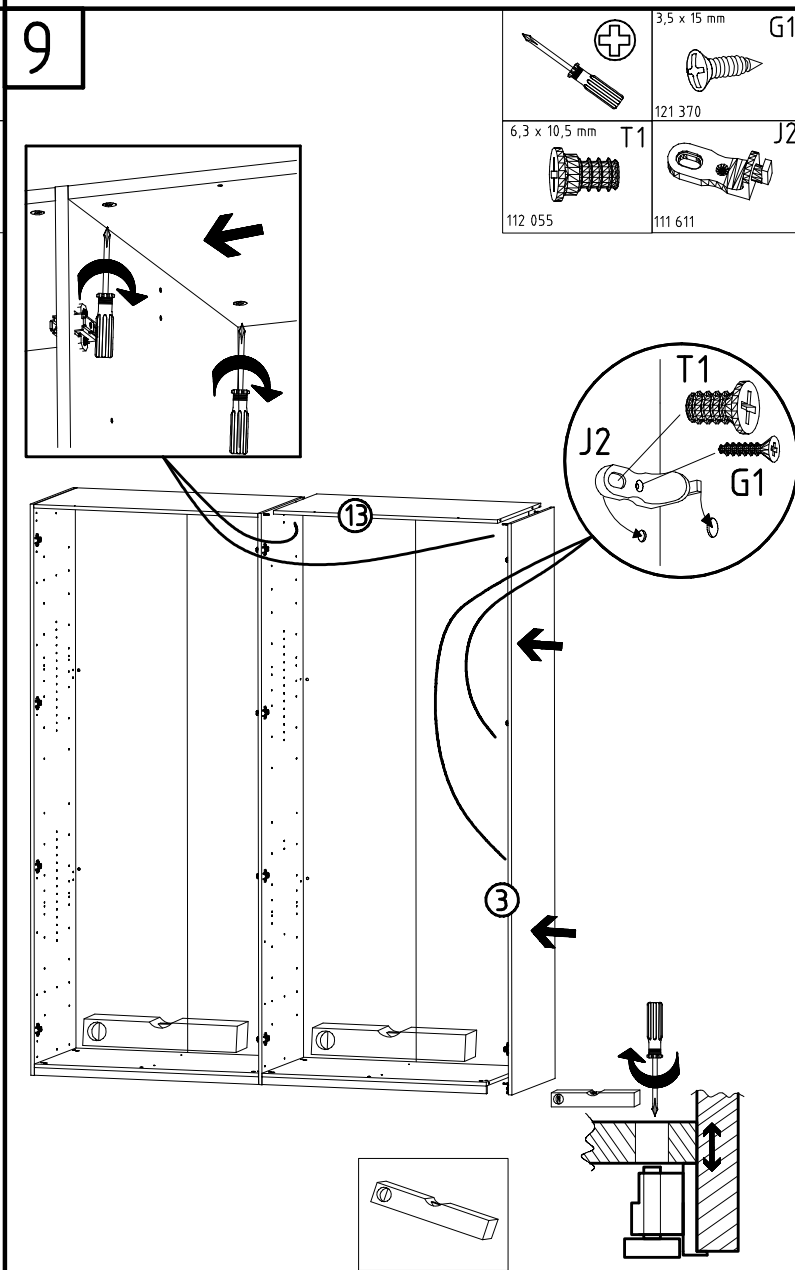



980264

15.08.17 / 15.11.19

11 19

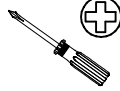
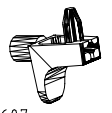
6 / 11

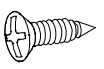
		L8
	111 607	
		K2
	117 002	
	3,5 x 15 mm	G1
		
	121 370	K10
	100cm	
	112 400	

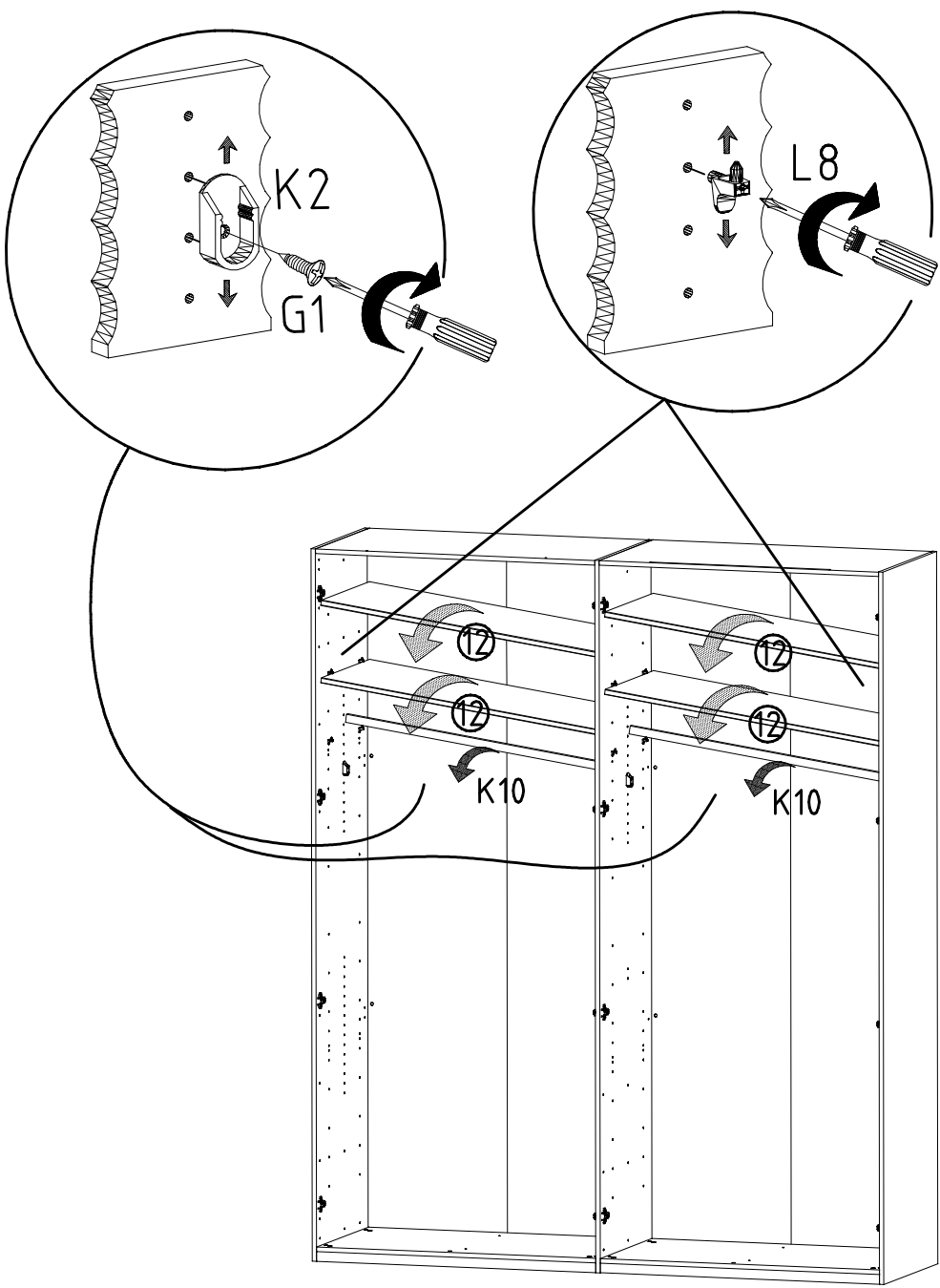

11

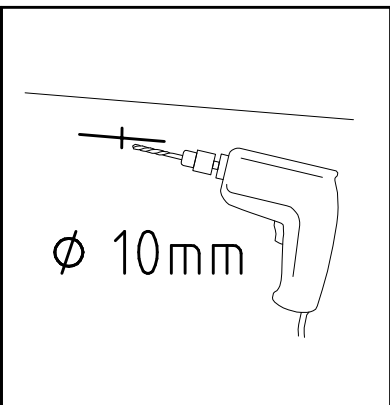
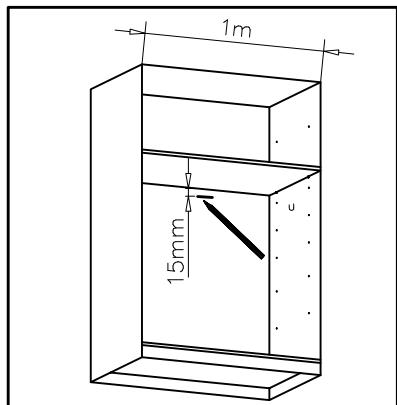
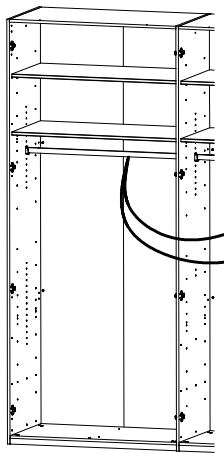

	 111 611
 $\phi 10\text{mm}$	<b>SP13</b> 4 X 13mm 121 122

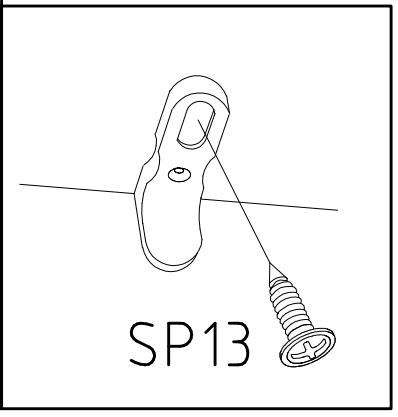
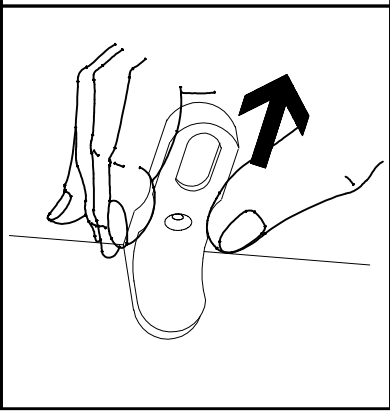
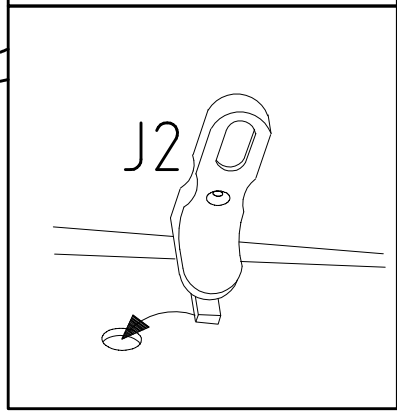

12

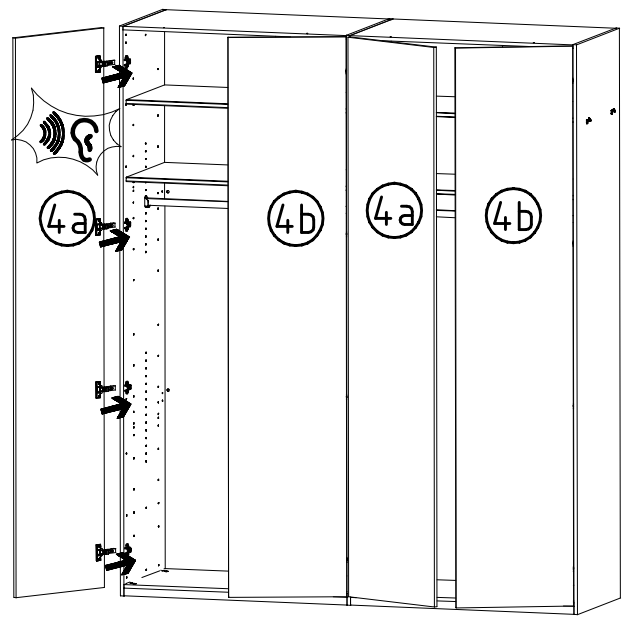
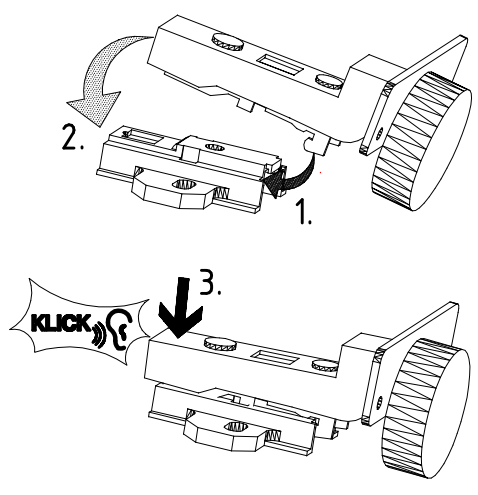

13

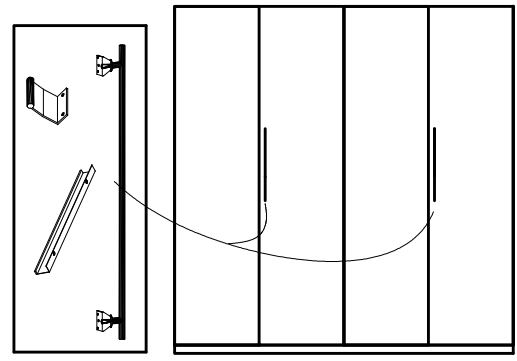
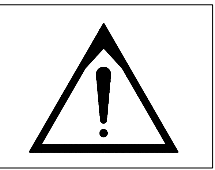
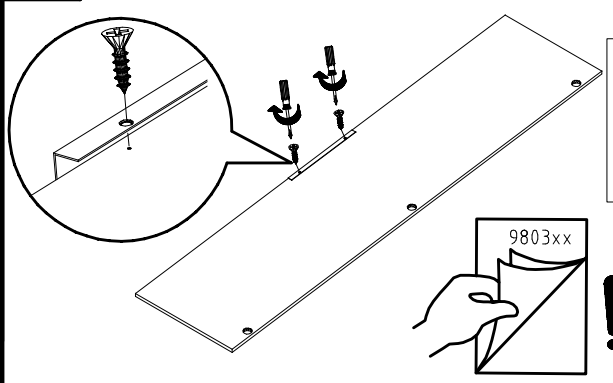



14

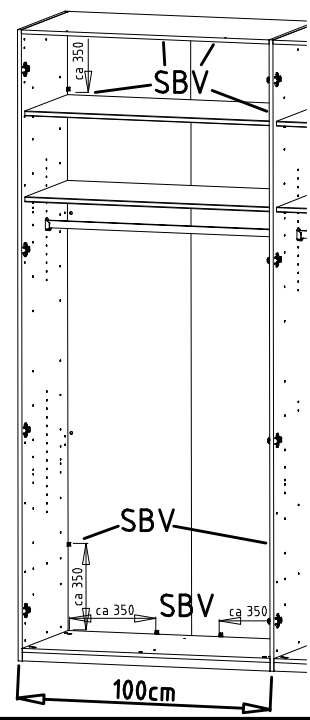
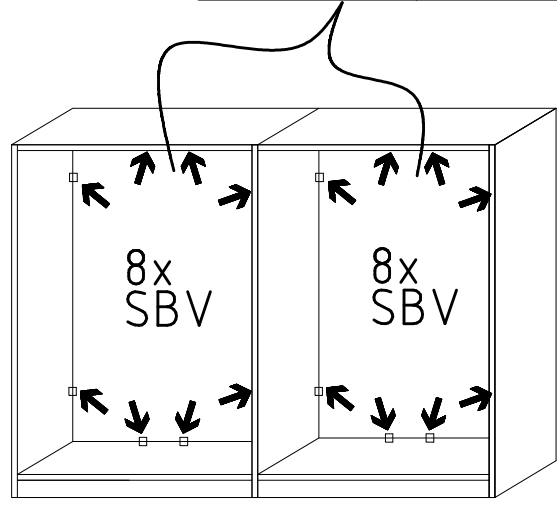
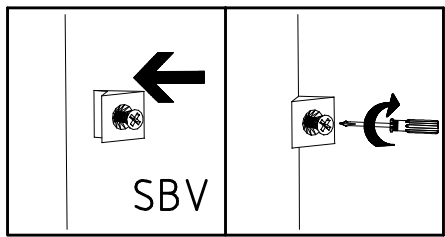
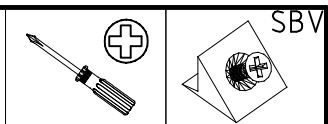

15

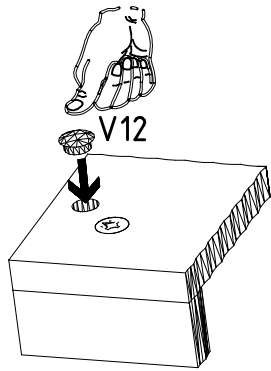
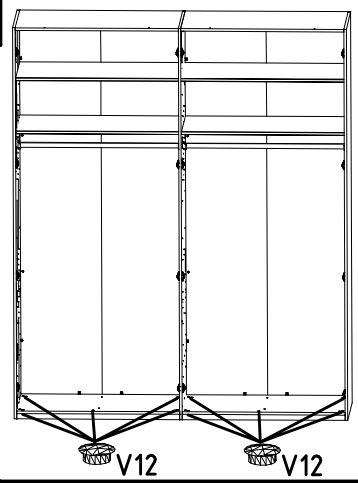

16

