



# PADUA LIGHT 4

43-064-...-3

1/11





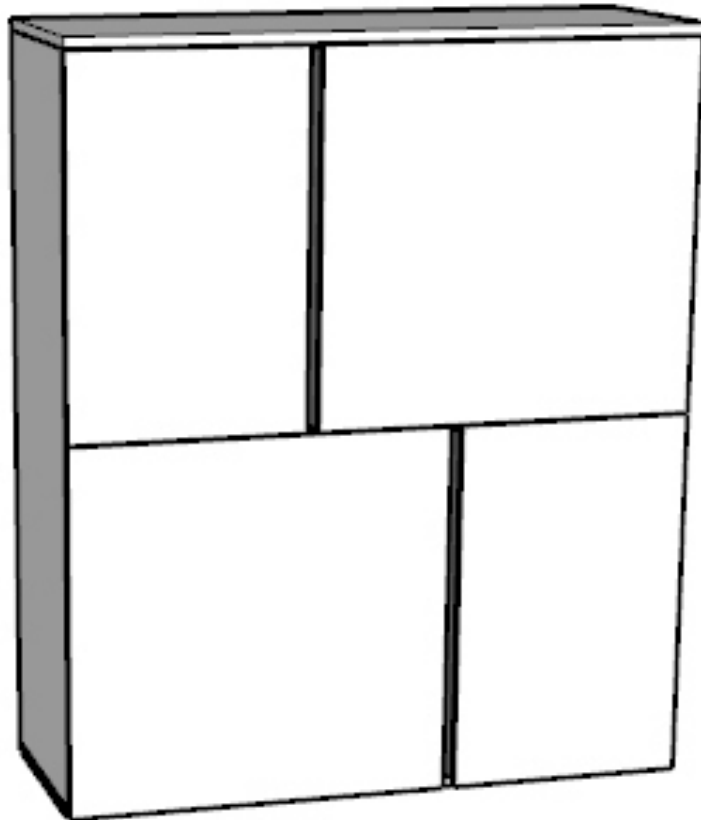
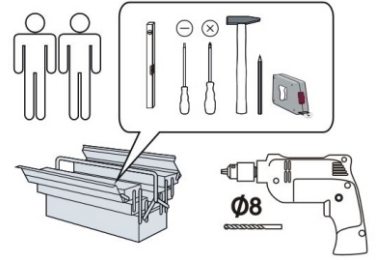

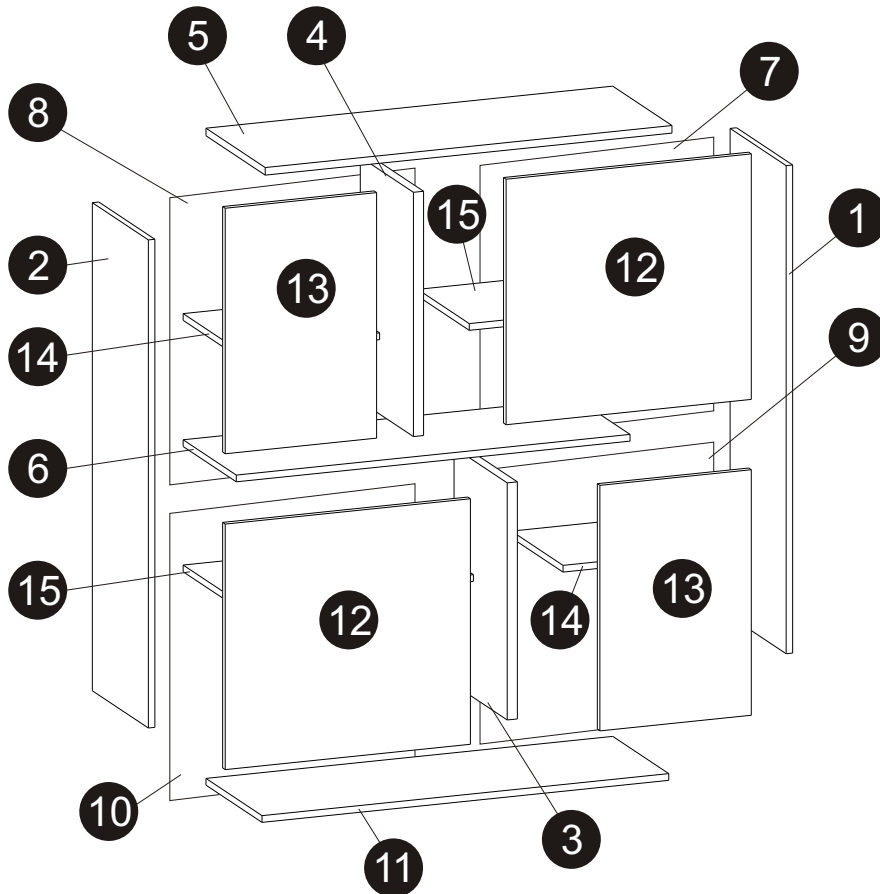

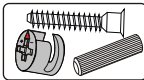

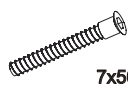
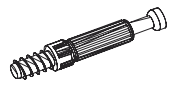

wyprodukowano dla / made for / produziert für  
**BEGA GRUPPE**  
producent: **MEBLE OKMED POLAND**

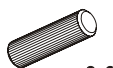

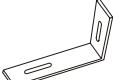
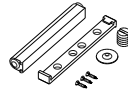

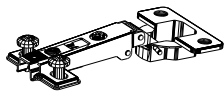

 1/2 	11	16x350x1002	x1
	6	16x332x969	x1
	12	16x583x604	x1
	12	16x583x604	x1
	13	16x583x373	x1
	13	16x583x373	x1
	5	18x370x1002	x1
	10	3x579x608	x1
	9	3x579x377	x1
	8	3x596x377	x1
7	3x596x608	x1	

2/2	2	16x350x1159	x1
	1	16x350x1159	x1
	15	16x322x587	x2
	14	16x322x356	x2
	3	25x332x562	x1
	4	25x332x580	x1

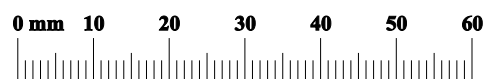

		
KK1	x1	K1
		7x50
		ZM1B
		x14
		
ZM1A	x14	ZM1
		x14
		KD1
		x20
		
SS4	x5	W1
		x5
		KS1
		x1
		
OM1	x4	S1
		x14
		KRW1
		x1
		
W1	x14	PP
		x16
		W11
		x2
		
PL1	x14	Z1P
		x8
		ZP
		x8



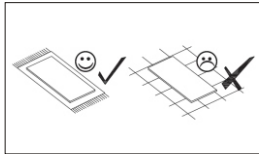

4x13
W4
x16

01

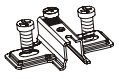

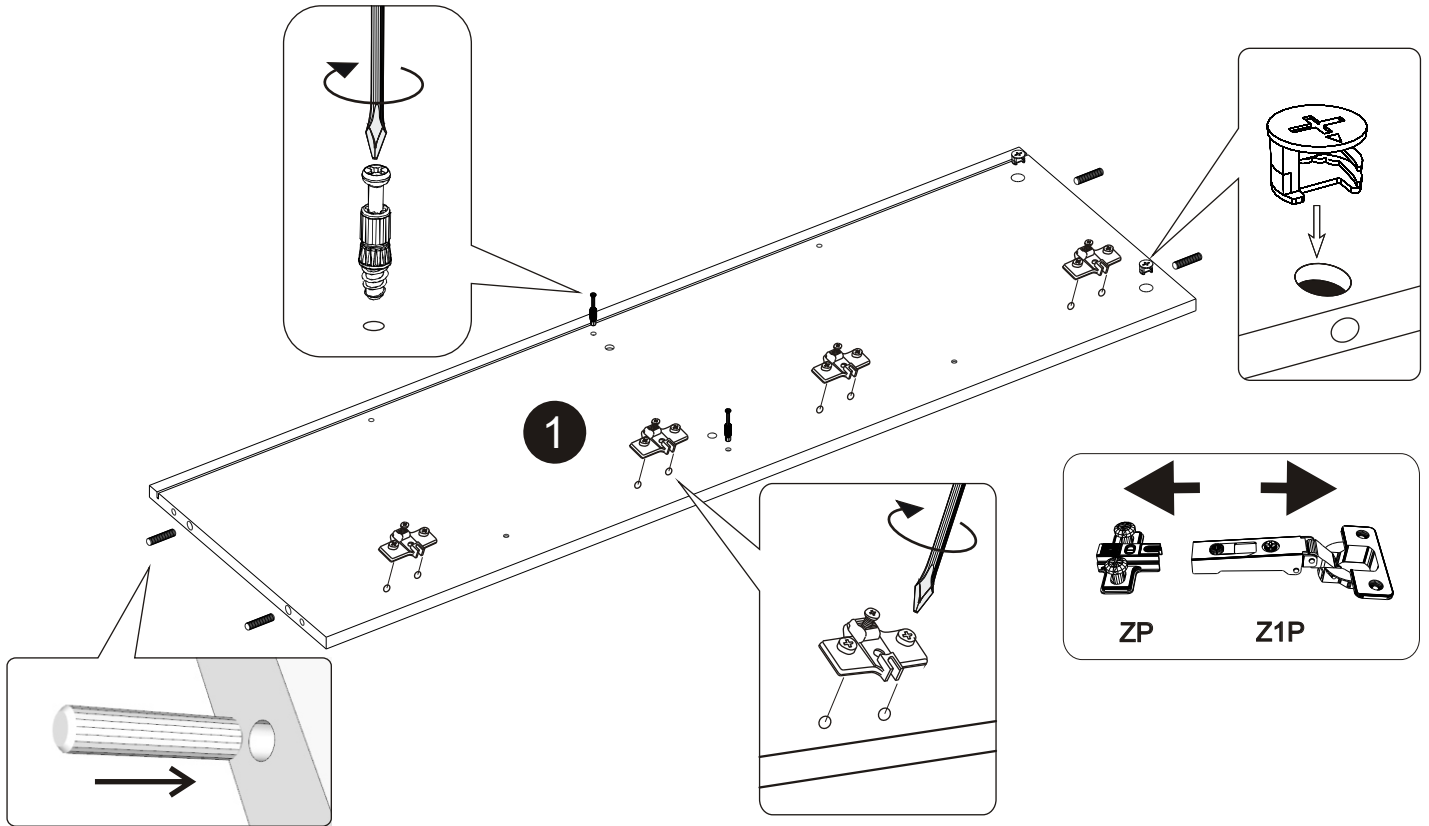

	8x35				15x12,5		
KD1	x4	ZM1B	x2	ZM1A	x2	ZP	x4

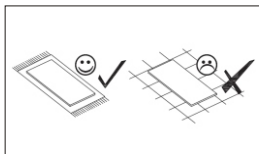

02

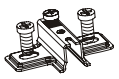

	8x35				15x12,5		
KD1	x4	ZM1B	x2	ZM1A	x2	ZP	x4

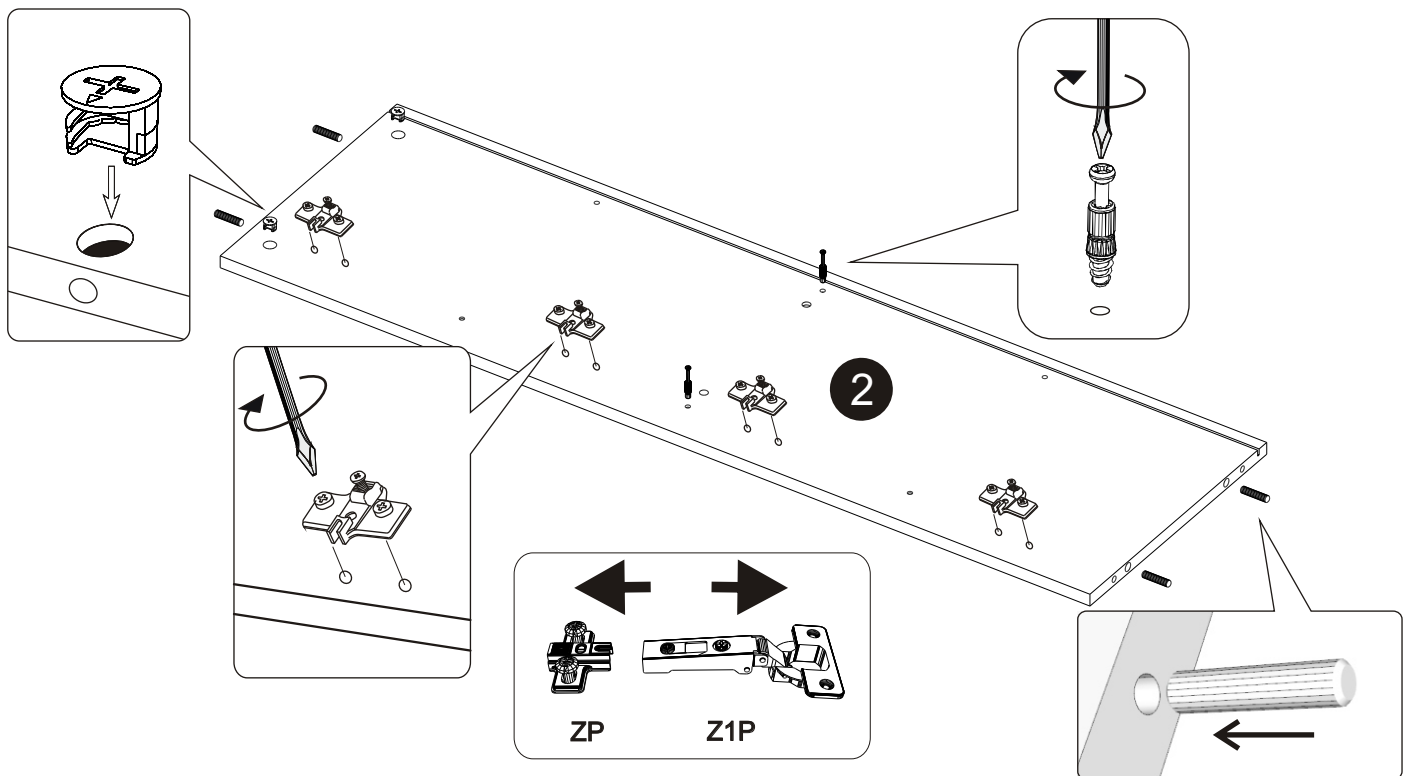

## 03

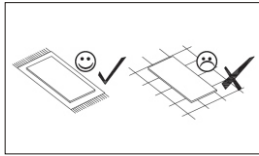

	x2		x2		x4
OM1	x2	ZM1A	x2	KD1	x4

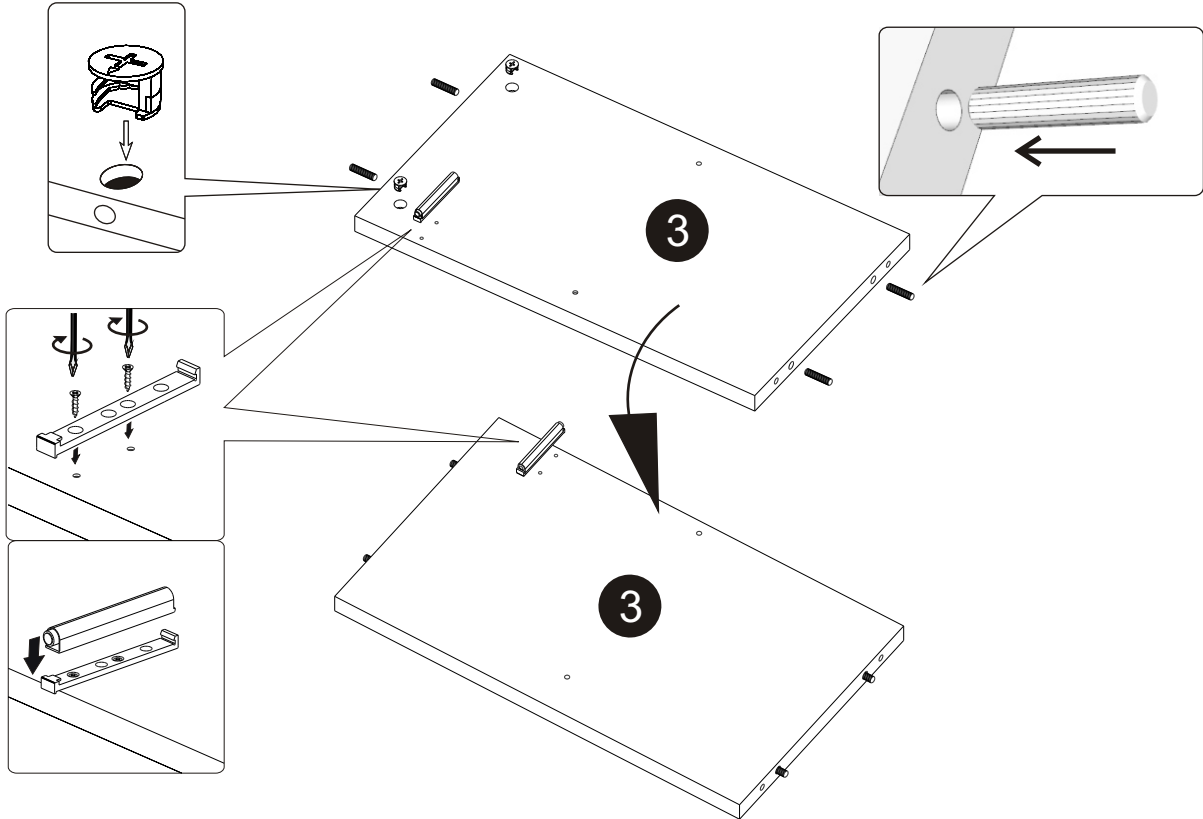

## 04

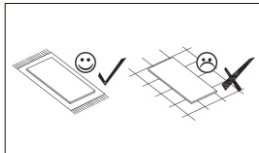

	x2		x4		x4
OM1	x2	ZM1A	x4	KD1	x4

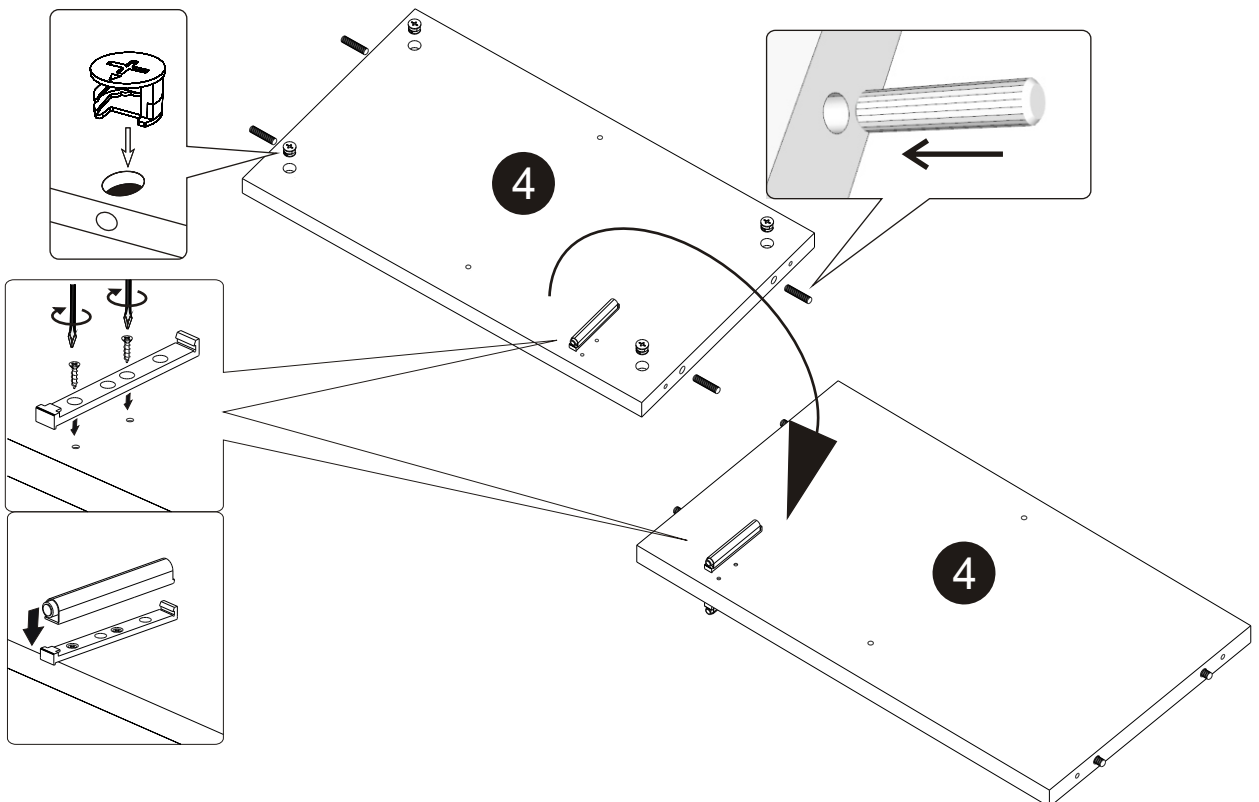

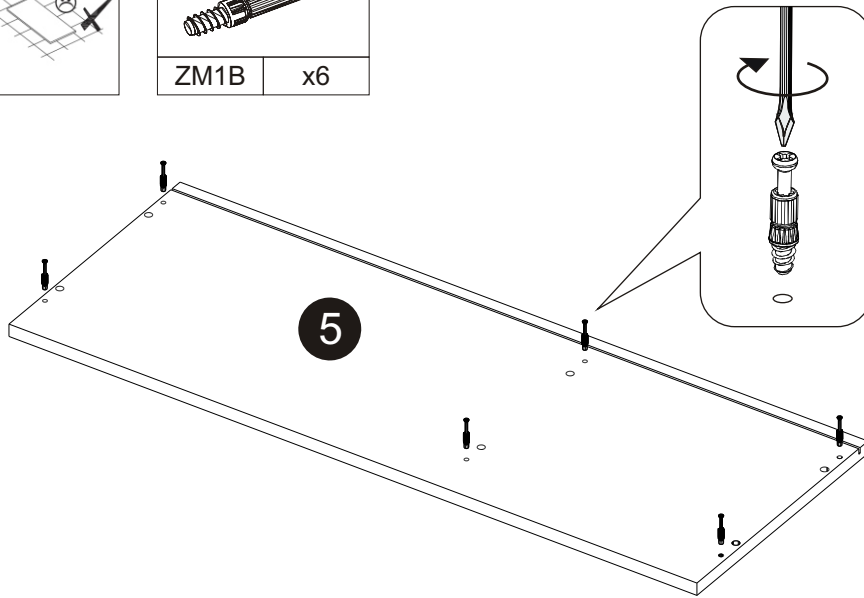
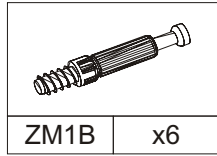
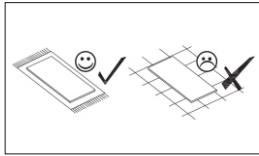

05

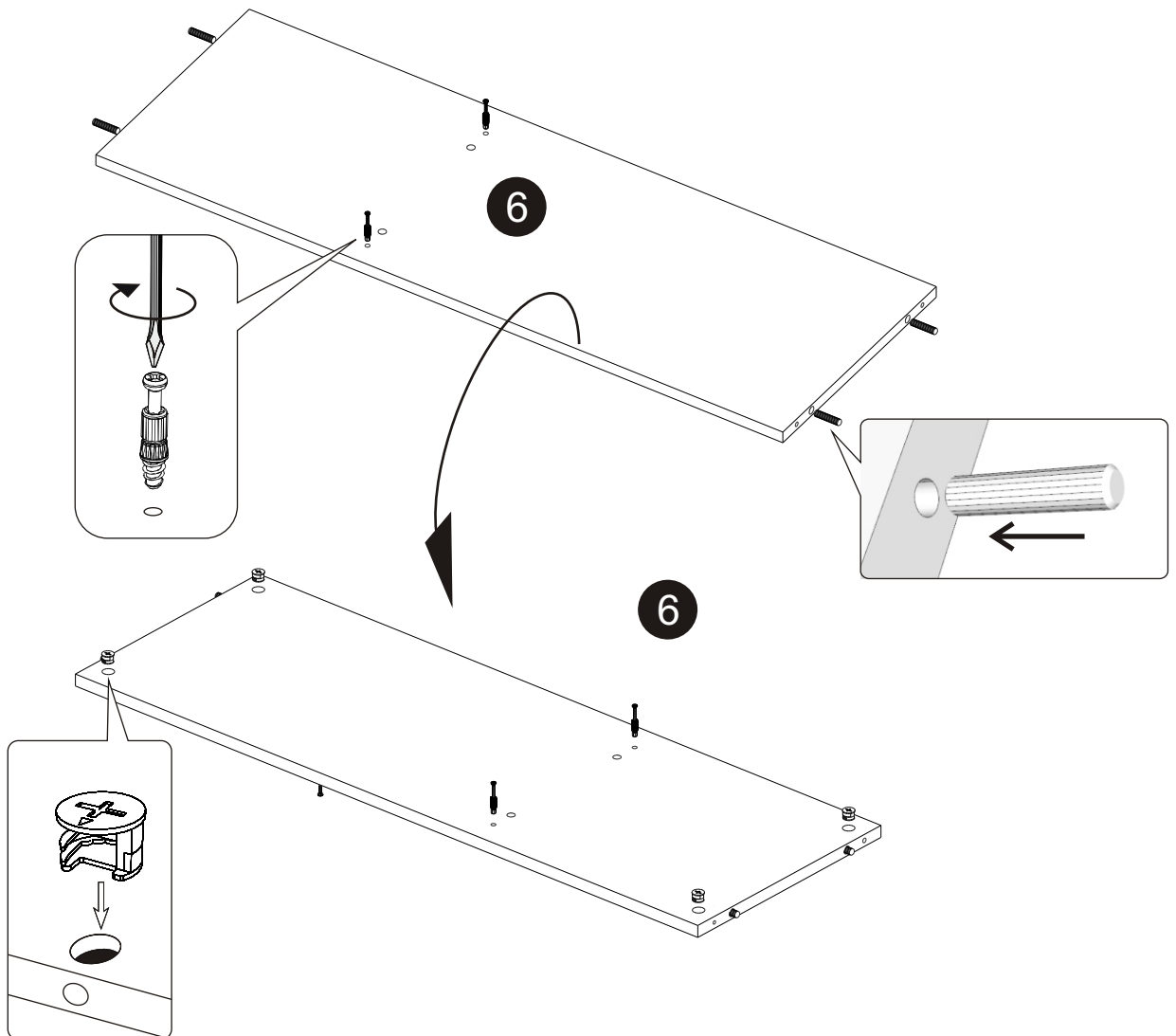
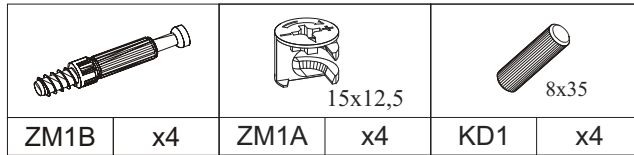
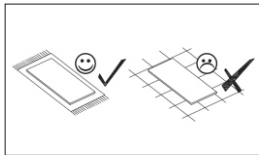

06



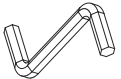

## 07

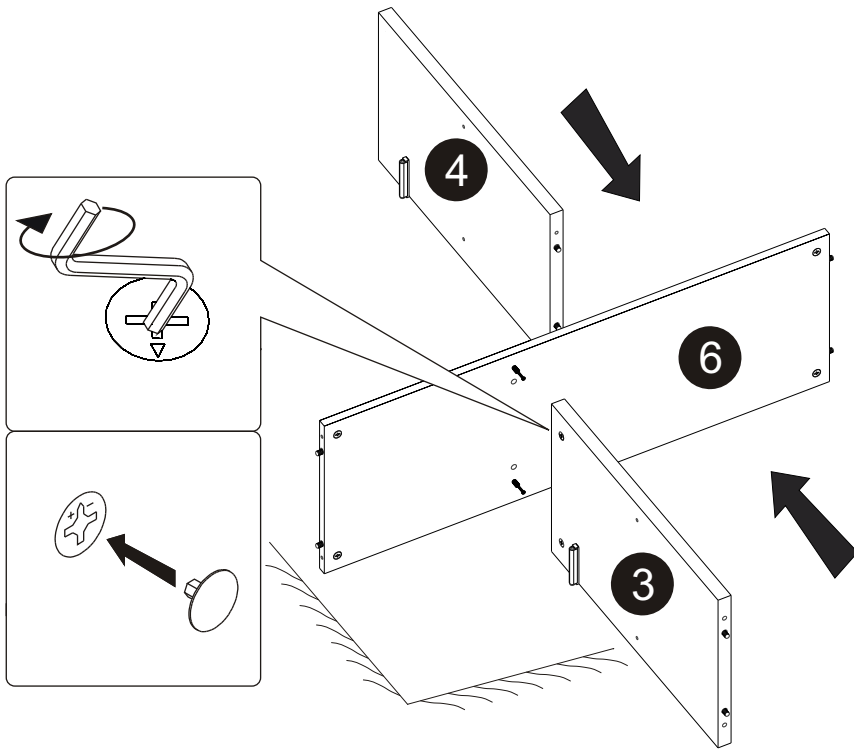
			
KK1	x1	ZM1	x4



## 08

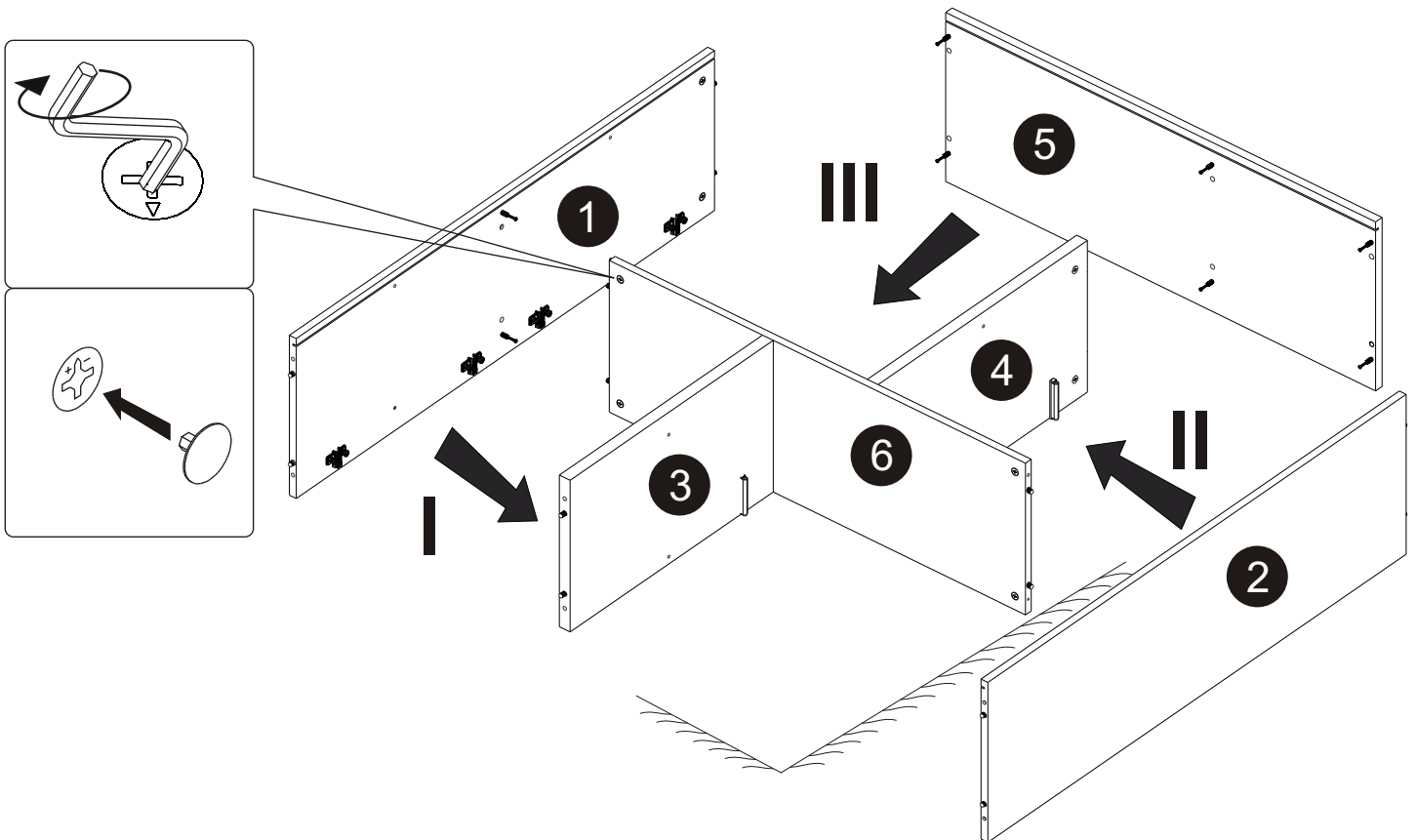

			
KK1	x1	ZM1	x10

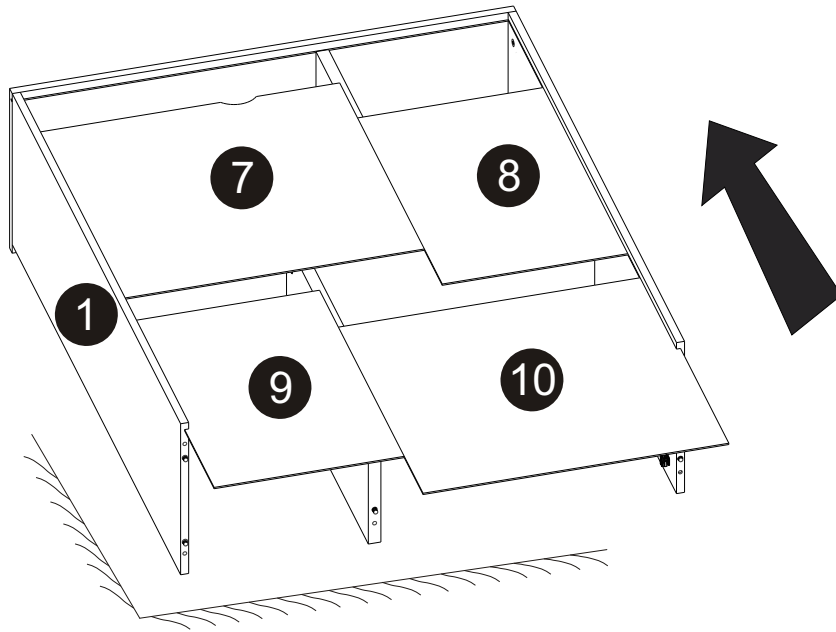

09



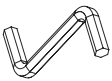

10

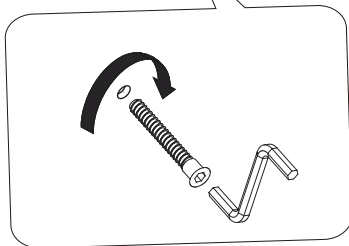
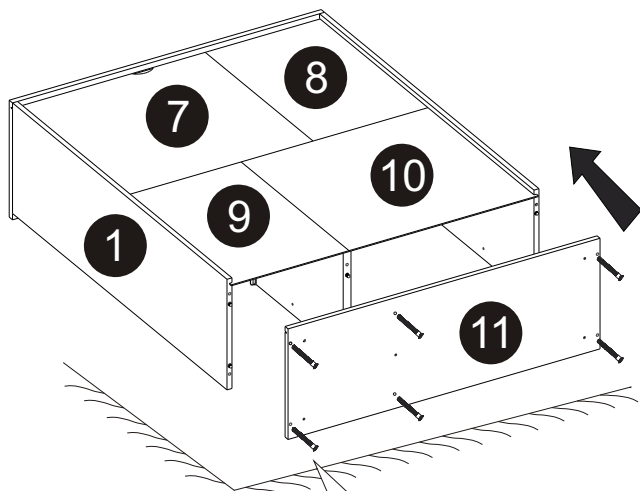
			
KK1	x1	K1	x6



11

			
SS4	x5	W1	x5

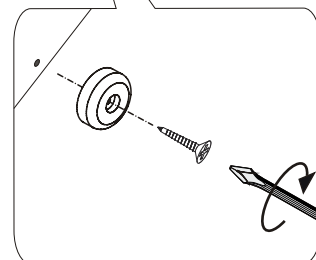
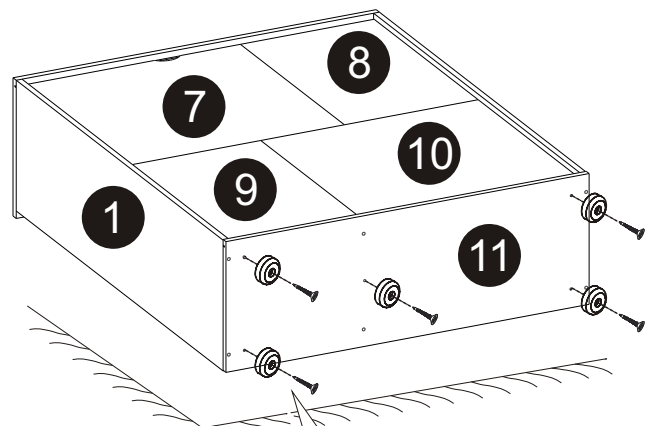

## 12

S1	x14	W1	x14	PL1	x14

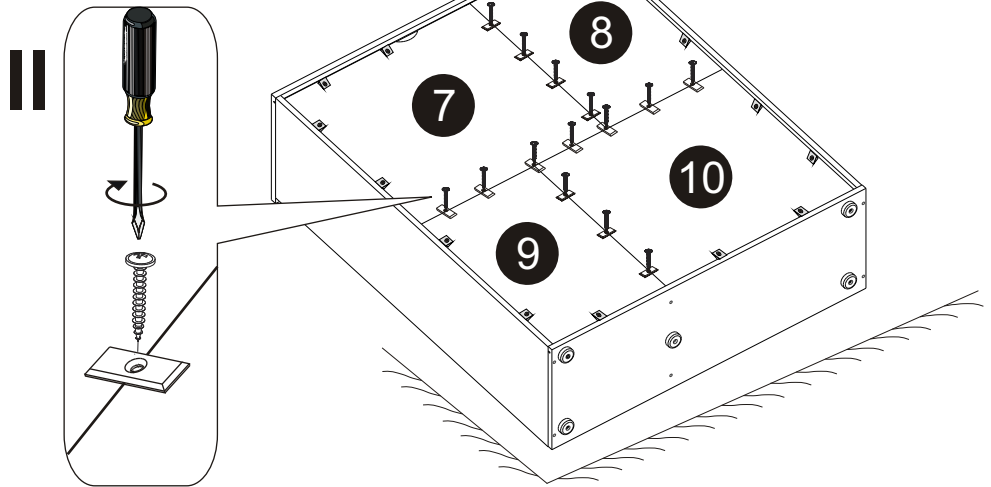
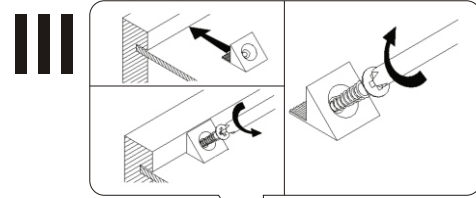
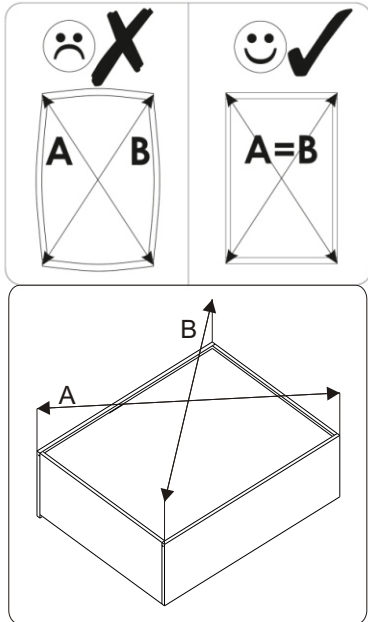

## 13

PP	x16

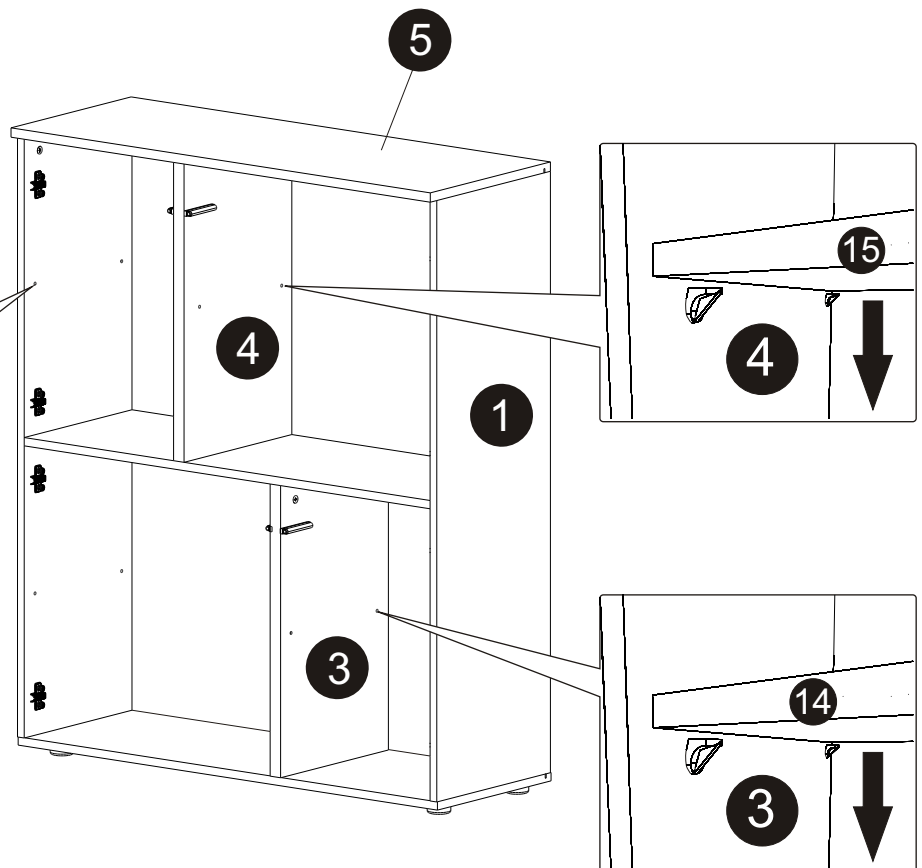
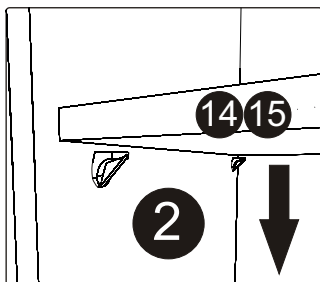
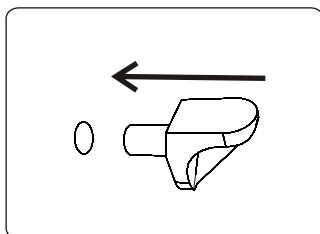



## 14

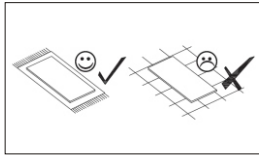

	x4		x8		x2
Z1P	x4	W4	x8	OM1	x2

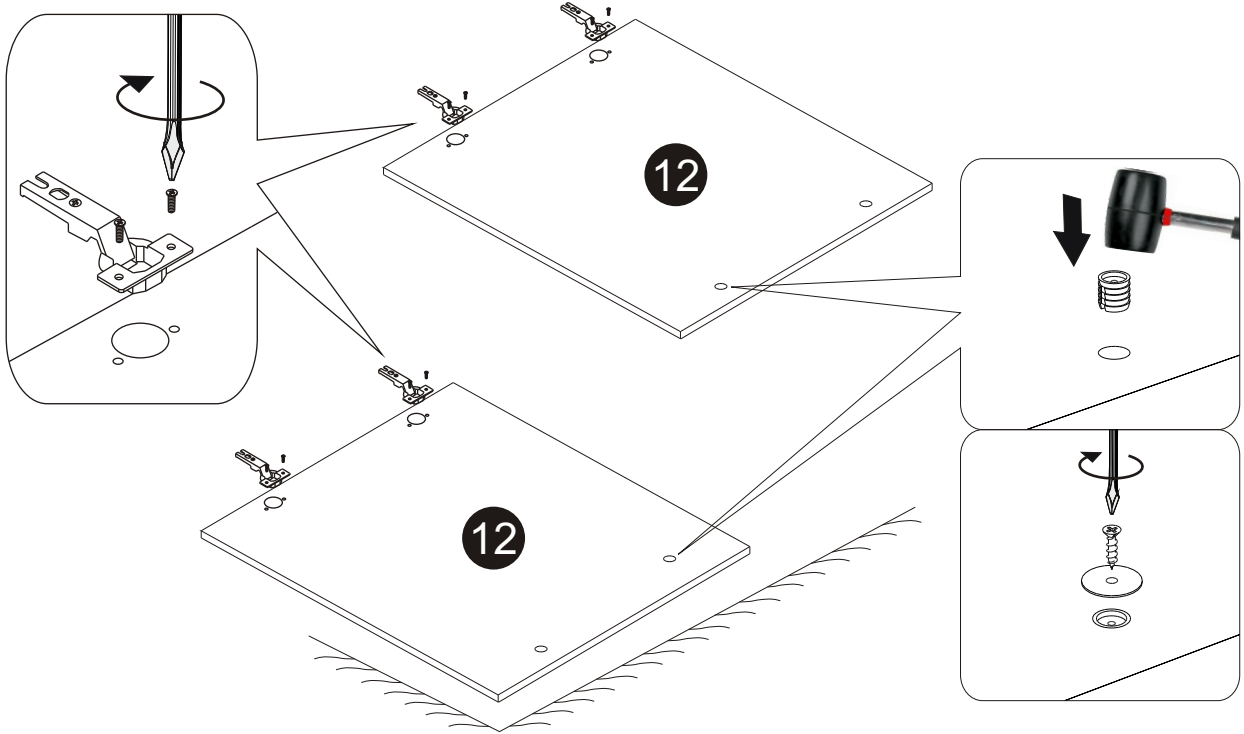

## 15

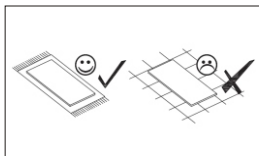

	x4		x8		x2
Z1P	x4	W4	x8	OM1	x2

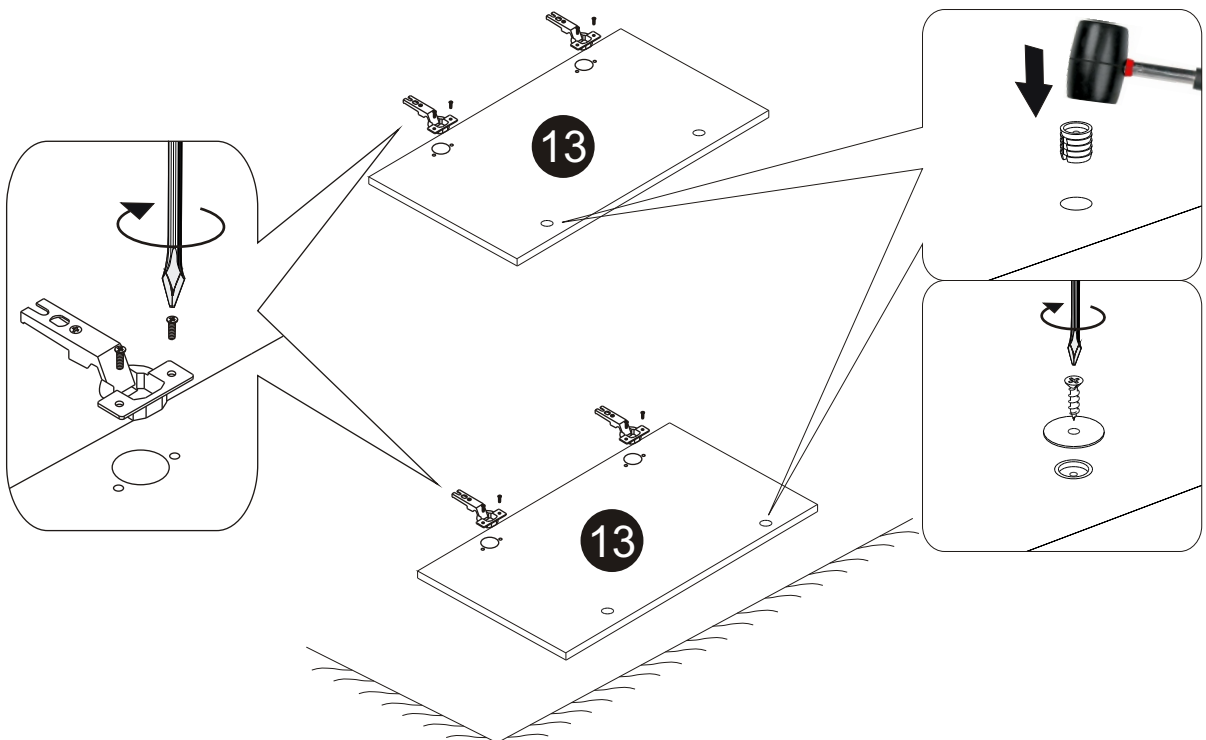

16

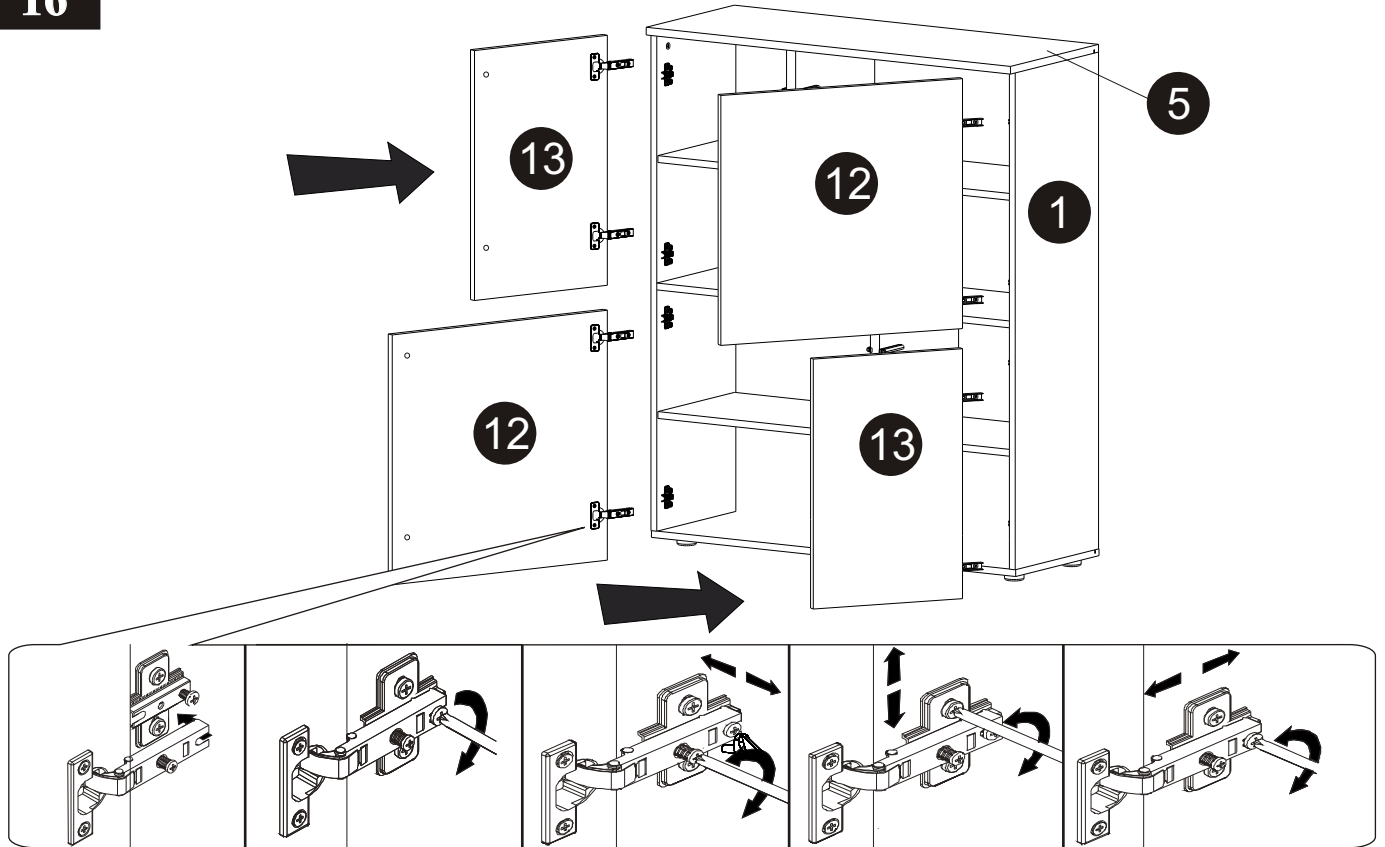

17

KS1	x1	W11	x2	KRW1	x1

