

# 992 401

**MONTAGEANLEITUNG**  
**INSTRUCTIONS DE MONTAGE**  
**ASSEMBLY INSTRUCTIONS**  
**MONTAGEAANWIJZING**

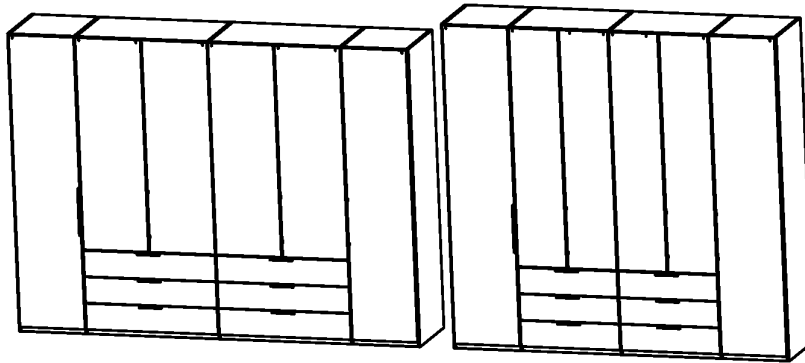
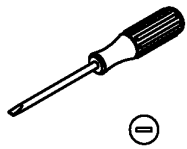
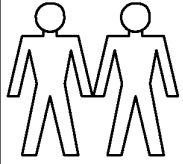

- D - Beispiel
- GB - example
- FR - exemple
- NL - voorbeeld
- CZ - příklad
- SLO - primer
- H - példa
- RO - Exemplu
- I - Esempio
- RUS - пример
- TR - Örnek
- PL - Przykład
- E - Ejemplo
- P - Exemplo

**DEUTSCH** - Alle Pakete öffnen und alle Aufbauanleitungen lesen. Fachkundige Montage erforderlich. Unsach- gemäße Montage kann zu Unfällen führen. Möbel/ Gegenstand könnte kippen oder umfallen. **WICHTIG!** Achten Sie darauf, dass Sie Schrauben/ Beschläge entsprechend der Wand-/ Deckenbeschaffenheit und mit aus- reichender Tragfähigkeit verwenden. Erkundigen Sie sich ggf. beim Eisenwarenfachhandel.

**FRANÇAIS** - Tous les forfaits peuvent ouvrir et lire toutes les instructions de montage. Le montage doit être effectué par une personne compétente. Un montage mal effectué peut provoquer la chute du meuble/de l'objet et blesser quelqu'un. **ATTENTION!** Adaptez les vis et ferrures au matériau du mur/ plafond et au poids de l'objet. En cas de doute, demandez conseil à un vendeur spécialisé.

**Español** - Abrir todos los paquetes y leer las instrucciones de montaje con cuidado. Montaje de expertos necesario. Un montaje inadecuado puede dar lugar a accidentes. Muebles/ objeto podría inclinarse o caerse. **¡IMPORTANTE!** Asegúrese de que utiliza los tornillos / accesorios de acuerdo con las propiedades adecuadas para pared/ techo y con capacidad de peso suficiente. Infórmese en su ferretería.

**Português** - Todos os pacotes podem abrir e ler todas as instruções de montagem. Montagem só de pessoas experientes. A montagem incorreta pode levar a acidentes. Móveis/objeto poderia cair. **IMPORTANTE!** Dê atenção que os parafusos / as guarnições correspondem à qualidade das paredes e que têm capacidade suficiente para a carga. Informa se eventualmente numa loja de ferragens.

**NEDERLANDS** - Alle pakketten kunnen openen en lezen alle montage-instructies. De montage dient te worden uitgevoerd door een vakbekwaam iemand. Foutieve montage kan er toe leiden dat het meubel/voorwerp kantelt of omvalt en beschadigt resp. iemand bezeert. **N.B.** Denk er aan dat de schroeven of het beslag dat je kiest geschikt moeten zijn voor de wand/het plafond waarin ze vastgezet moeten worden, en voldoende draagkracht moeten hebben. Neem bij twijfel contact op met de lokale vakhandel.

**MAGYAR** - Minden nyitott csomagokat és az összes összeszerelési utasításokat olvasson. Az összeszerelés lehetőleg hozzáértő személy végezze, mert nem megfelelő, hibás össze-, ill. felszerelés esetén a bútor feldőlhet, leszakadhat a falról, ezzel személyi sérülést vagy balesetet okozva. **FIGYELEM!** Válasszon olyan csavart, tiplít mely leginkább alkalmas az Ön otthonában található fal / mennyezet anyagához, és teherbíró képessége is megfelelő.

**ITALIANO** - Tutti i pacchetti aperti e leggi tutte le istruzioni per l'uso. Importante un montaggio corretto. Un montaggio sbagliato può causare incidenti. Assicurarsi di fissare il mobile alla parete o al soffitto con viti/accessori adatti in modo che non puo ribaltarsi o cadere. Usare solo ferramenta speciale. Il produttore non si assume nessuna responsabilità in caso di danni a persone o cose.

**SLOVENSKY** - Vsi paketi lahko odprete in preberete vsa navodila za montažo. Montáž by mala vykonať kvalifikovaná osoba. Pri nesprávnej montáži môže dôjsť k prevrhnutiu alebo pádu nábytku/ objektu a k prípadnému zraneniu osôb alebo poškodeniu majetku. **UPOZORNENIE!** Použite skrutky a kovanie, ktoré sú vhodné na použitie do materiálu danej steny/stropu a majú dostatočnú nosnosť. Ak si nie ste istí, obráťte sa na špecializovaného predajcu.

**ENGLISH** - Please open all packages and read the assembly instruction carefully. The assembly should be carried out by a qualified person, due to the fact that wrong assembly can lead to that the furniture/object topples or falls resulting in personal injury or damage. **NOTE!** Choose screws and fittings that are specially suited to the material in your wall/ceiling and have sufficient holding power. If you are uncertain, contact your local specialised retailer.

**Русский** - Все пакеты можно открыть и прочитать все инструкции по сборке. монтаж должен производиться специалистом. Неправильная установка может привести к несчастному случаю. Мебель может опрокинуться или упасть. **ВАЖНО:** Следите за тем, чтобы выбранные шурупы и другие крепежно-монтажные детали были достаточно прочно закреплены. Подробную информацию можете получить в специальных магазинах.

**Türkçe:** Başdan tüm paketleri açıp, tüm montaj talimatları okuyunuz. Montaj edilmesi için bir uzman gerekiyor. Yanlış montaj bir kazaya neden olabilir. Mobilyanız üstünüze düşebilir. **ÖNEMLİ!** Lütfen Dikkat Ediniz. Duvar yapısına göre yeterli kapasitede ve taşıma kabiliyetinde olan vidalar/parçalar kullanınız. Gerekirse bir uzmana ve/veya yapı-market mağazasına danışabilirsiniz.

**Česky** - Všechny otevřené balíky a všechny montážní pokyny přečtěte. Montáž by měl provést kvalifikovaný odborník. Nesprávná montáž může způsobit, že nábytek se může převrátit nebo se některý díl uvolní. Může tak dojít ke zranění člověka či dalším škodám. **UPOZORNĚNÍ!** zvolte šrouby a kování, které jsou vhodné pro daný typ nábytku a mají postačující spojovací nosnost. Nejste-li si jisti, obraťte se na nejbližší specializovaný obchod.

**POLSKI** - Prosimy otworzyć wszystkie pakiety i przeczytać wszystkie instrukcje montażu. Mebel powinien być montowany przez osobę do tego uprawnioną. Następstwem niewłaściwego montażu mebla może być przechylenie lub nawet przewracanie się mebla, w wyniku czego może dojść do uszkodzenia mebla i jego zawartości a nawet do wypadku. **UWAGA!** Okucia, śruby, haki jak i kołki muszą być dopasowane do wagi mebla z zawartością oraz do specyficznych właściwości muru lub sufitu. W przypadku wątpliwości prosimy zasięgnąć porady fachowca.

**Română** - Toate ofertele se pot deschide și citi toate instrucțiunile de asamblare. Este necesar un montaj profesional. Un montaj neprofesional poate duce la accidente. Mobilă / corpul de mobilă se poate inclina și cadea. **IMPORTANT!** Asigurați-vă ca suruburile și toate celelalte fitinguri se potrivească tipului de material din care este construit peretele sau tavanul și ca au o rezistență suficientă la preluarea sarcinii. Dacă este necesar, solicitați sprijin specializat în magazinul de fitinguri.

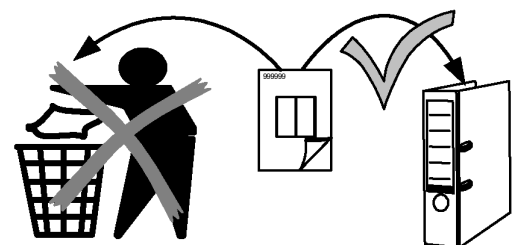

75/100cm

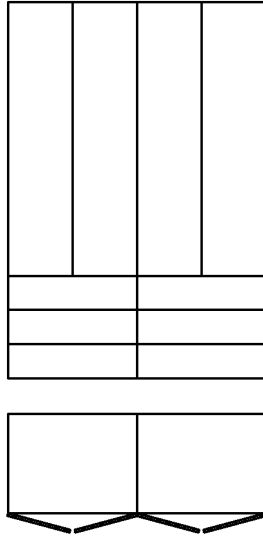

350cm

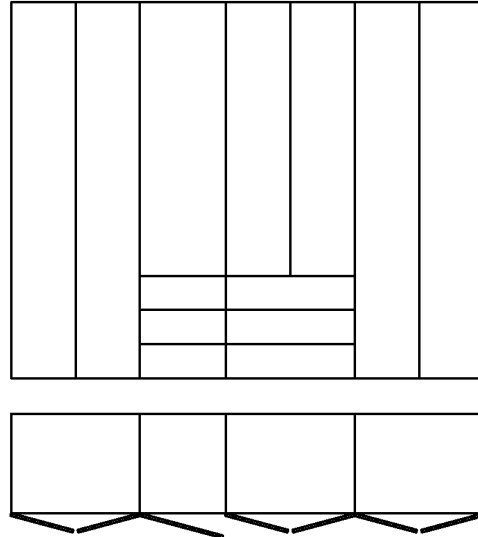

250cm/300cm

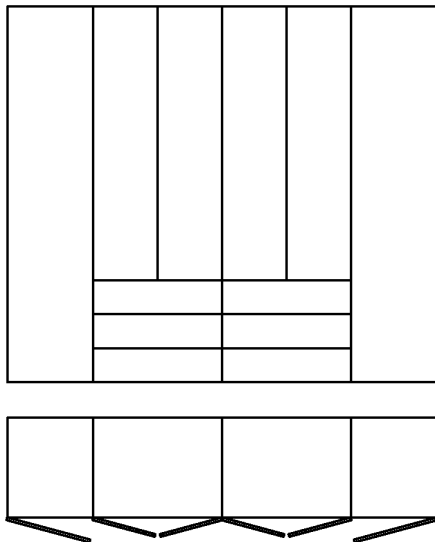

300/400cm

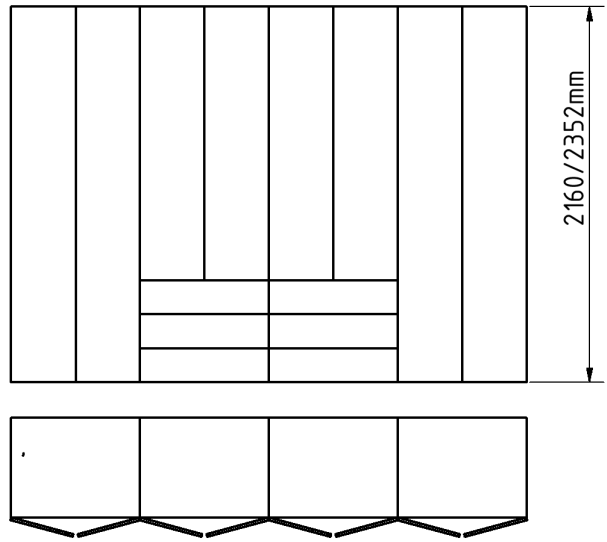



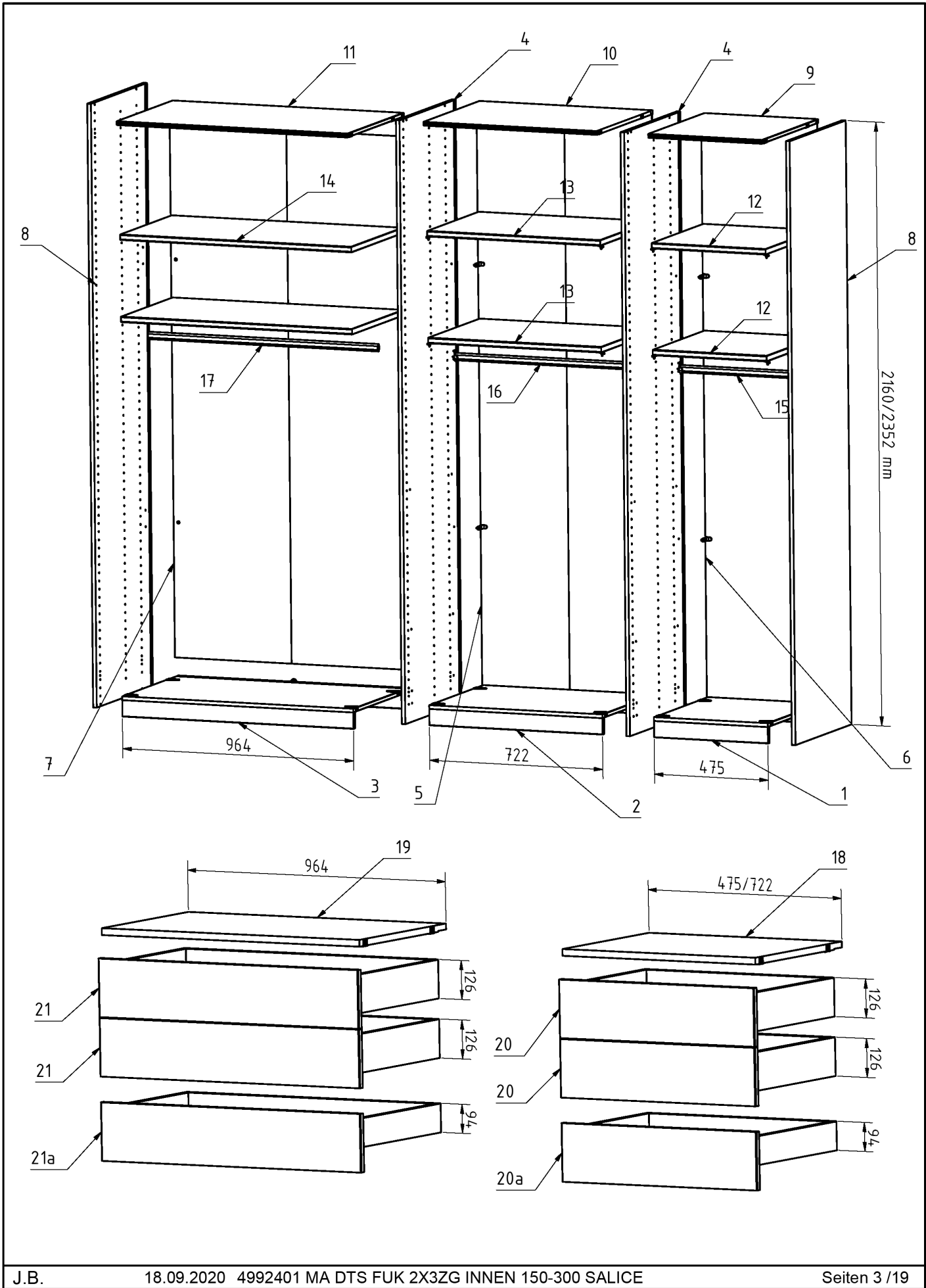

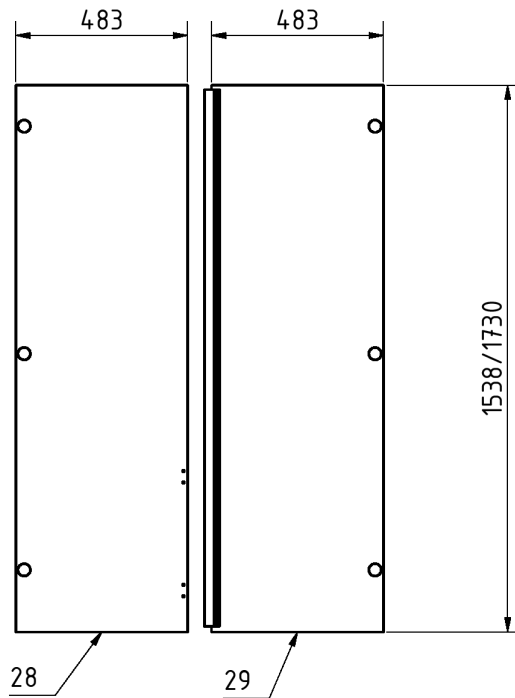
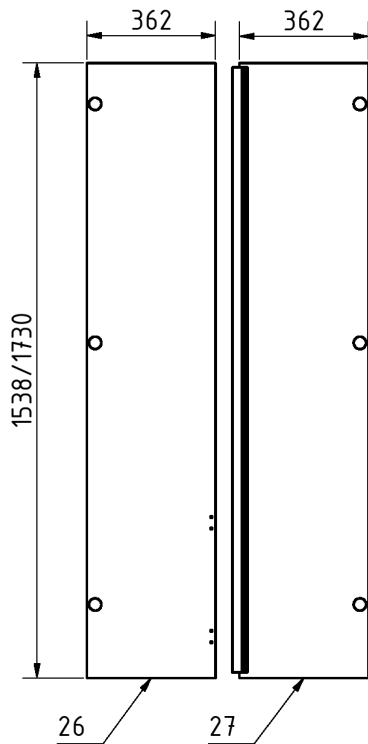
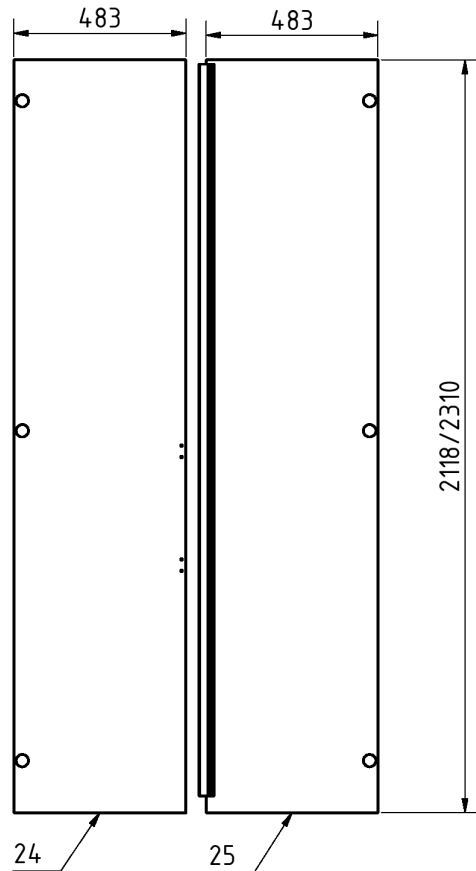
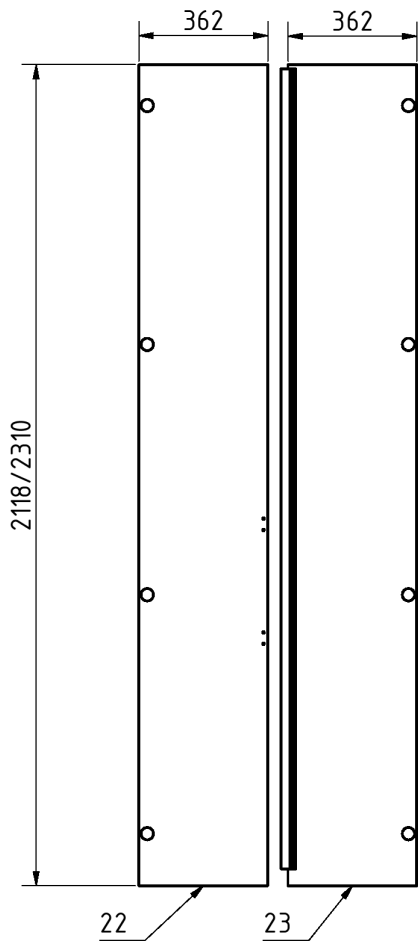

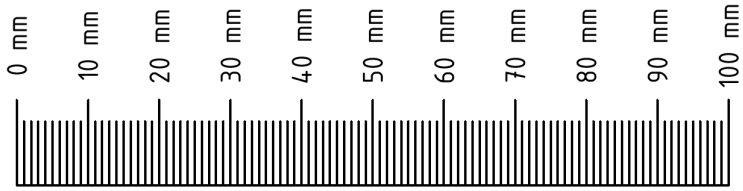

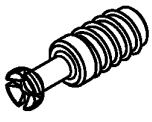
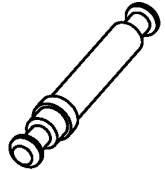
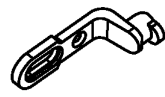
2160/2352mm

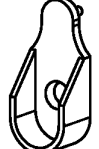
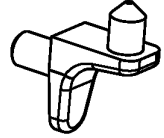
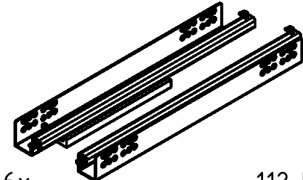

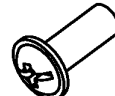
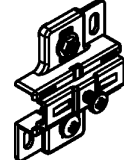
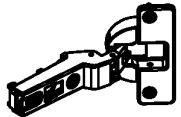

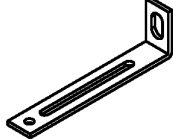

 12x 111 229	 14x 111 235	 16x 111 611	 6,3x10,5 16x 112 055	 3,5x15 24x 121 370	 8x 117 002	 32x 111 610
 6x 112 521	 6,3x11 12x 121 167	 M4x7 6x 111014	 M4 6x 113 809	 D6 18-28x 112 321	 18-28x 112 320	
 4,0x14 24-48x 121 135	 0-4x 111 036	 4,5x15 0-8x 121 098				

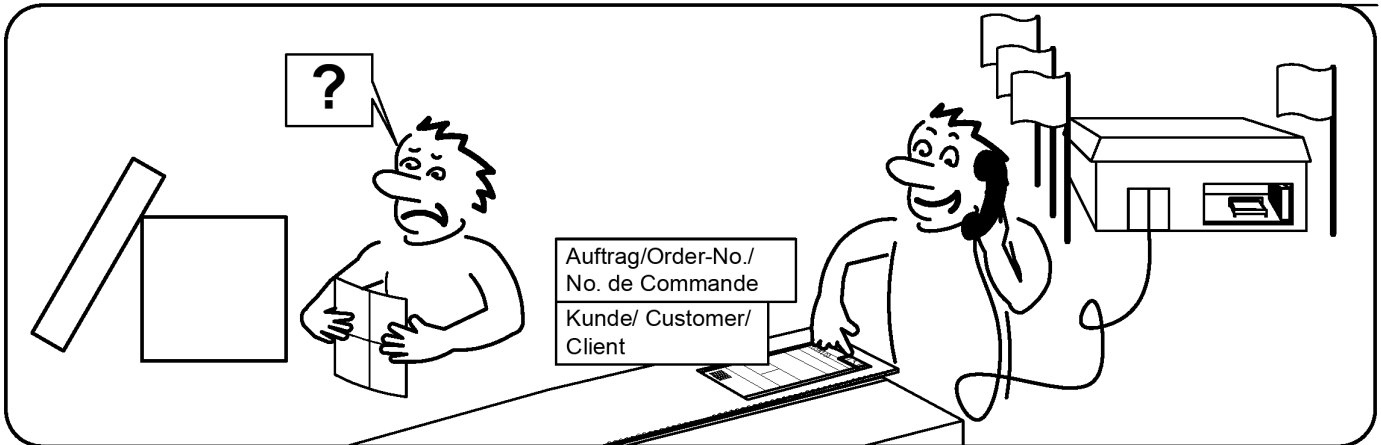

# A

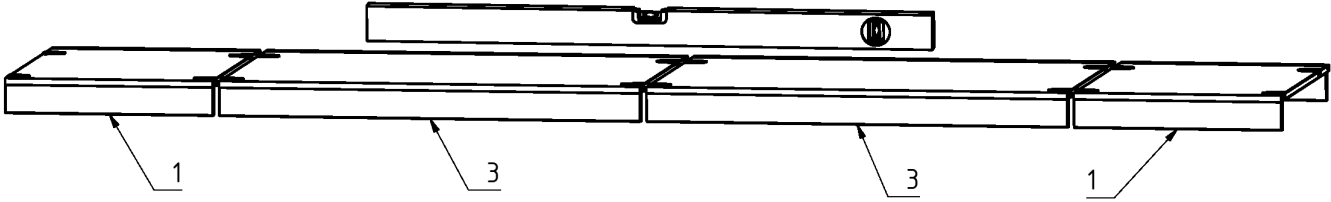
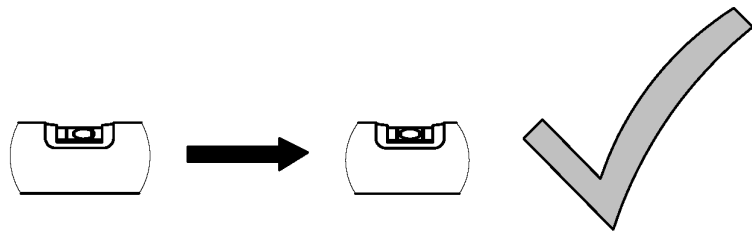

# B

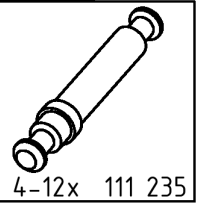

1-3x

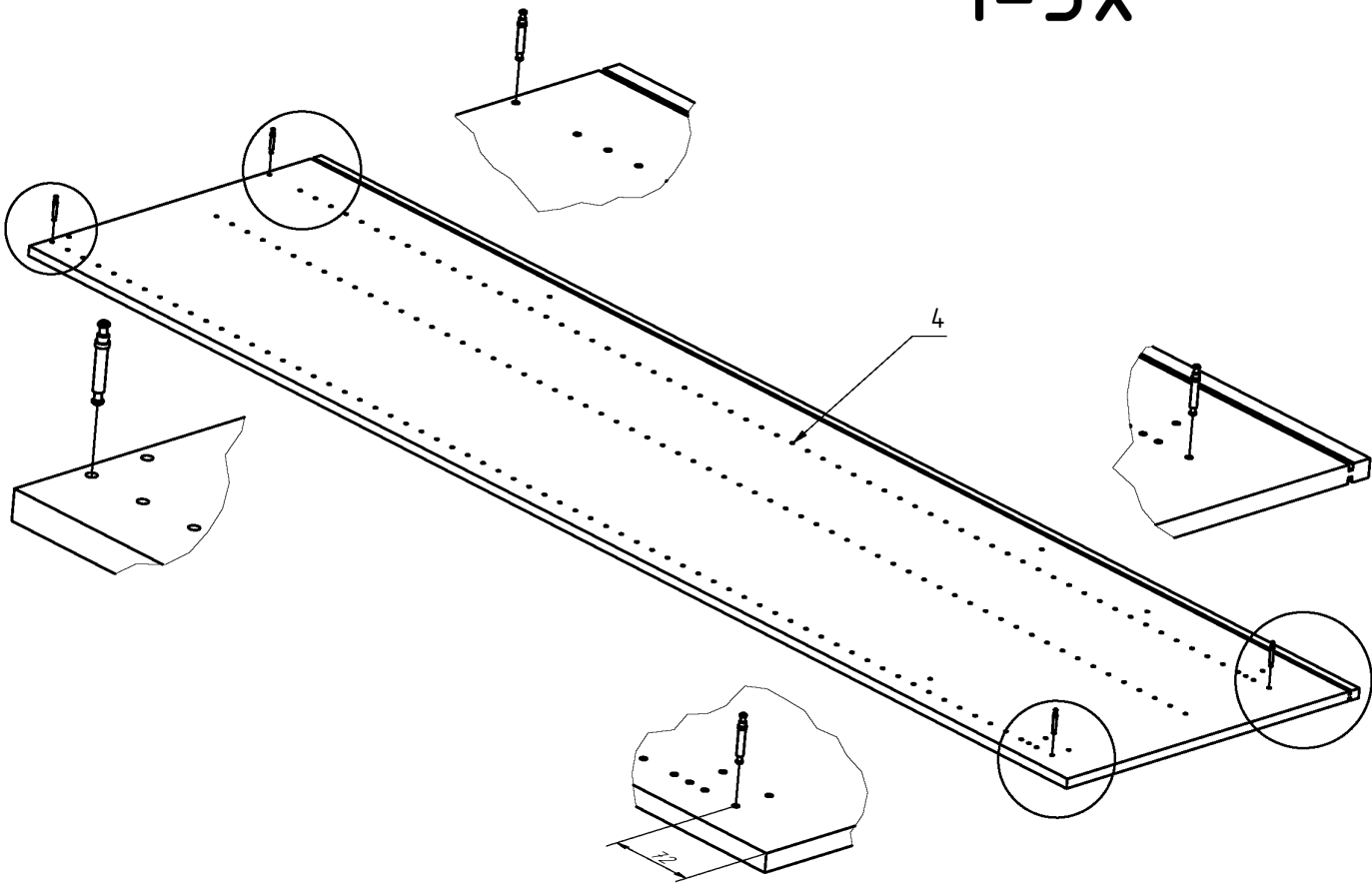

**C**

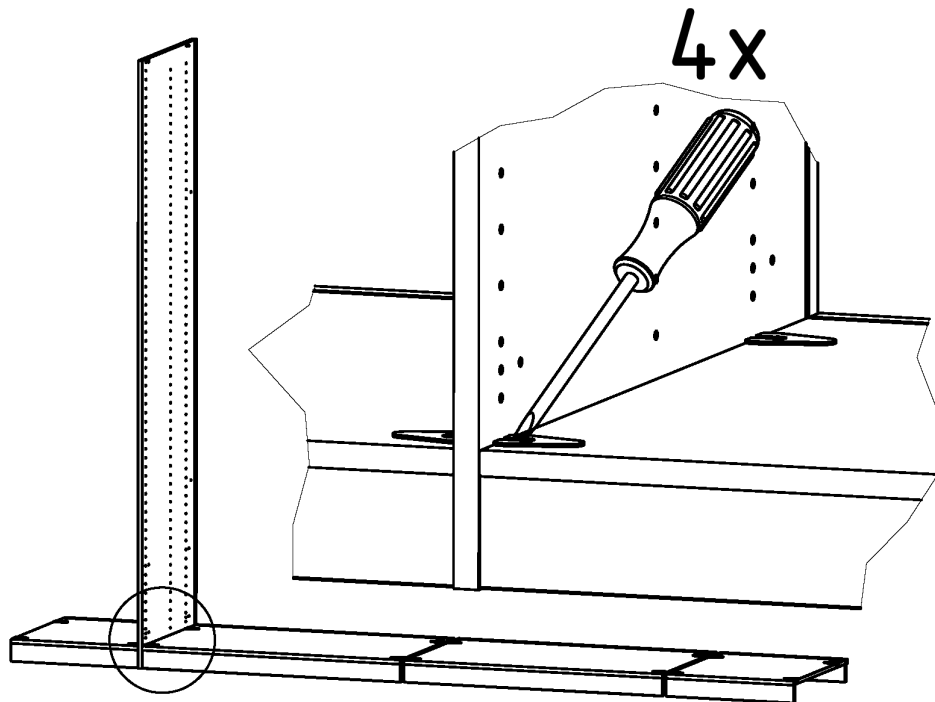

**D**





4x 111 611  
6,3x10,5

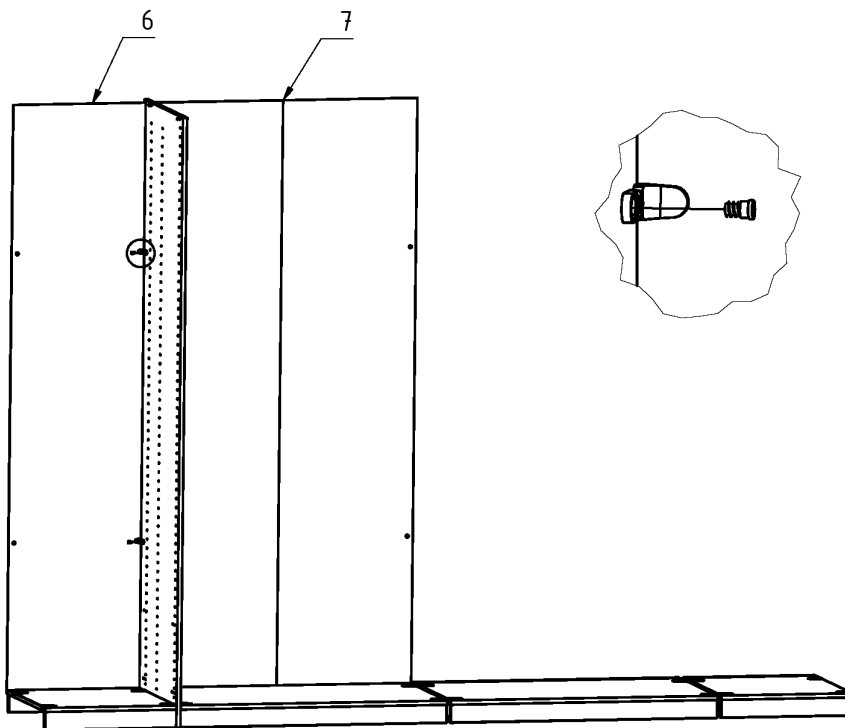

4x 112 055



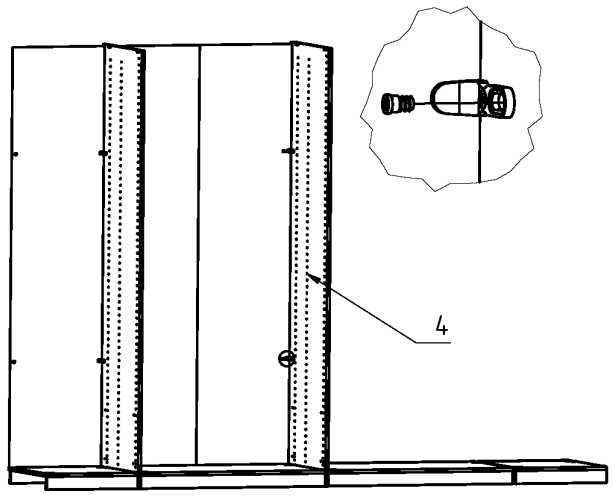

**E**

	6,3x10,5 
2x 111 611	2x 112 055



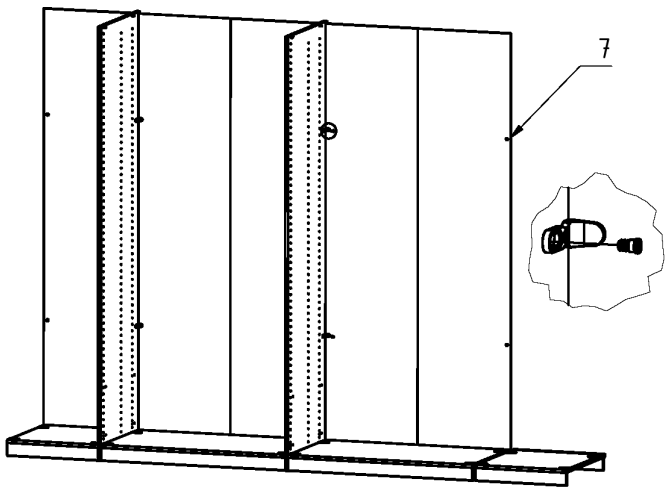

**F**

	6,3x10,5 
2x 111 611	2x 112 055



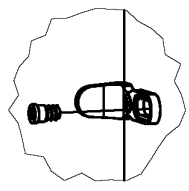
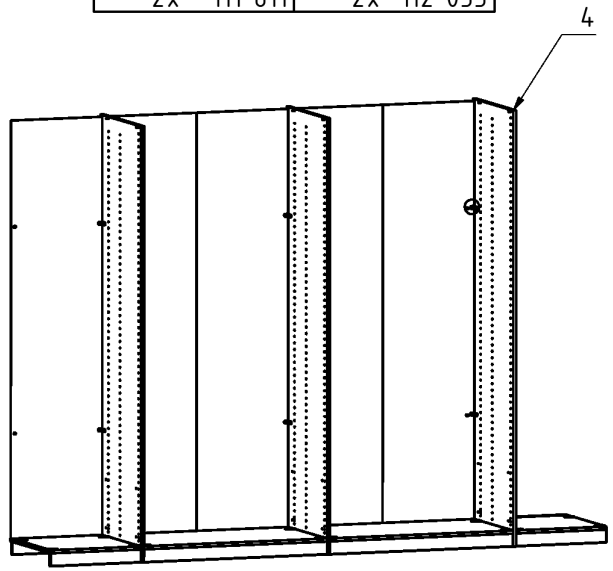

**G**

	6,3x10,5 
2x 111 611	2x 112 055



**H**

	6,3x10,5 
2x 111 611	2x 112 055

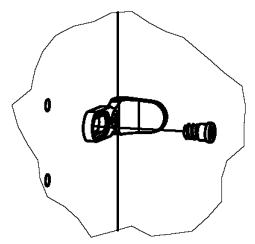
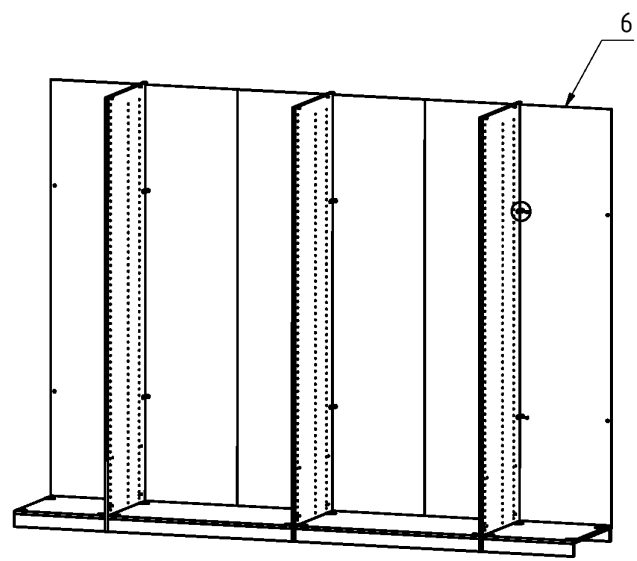



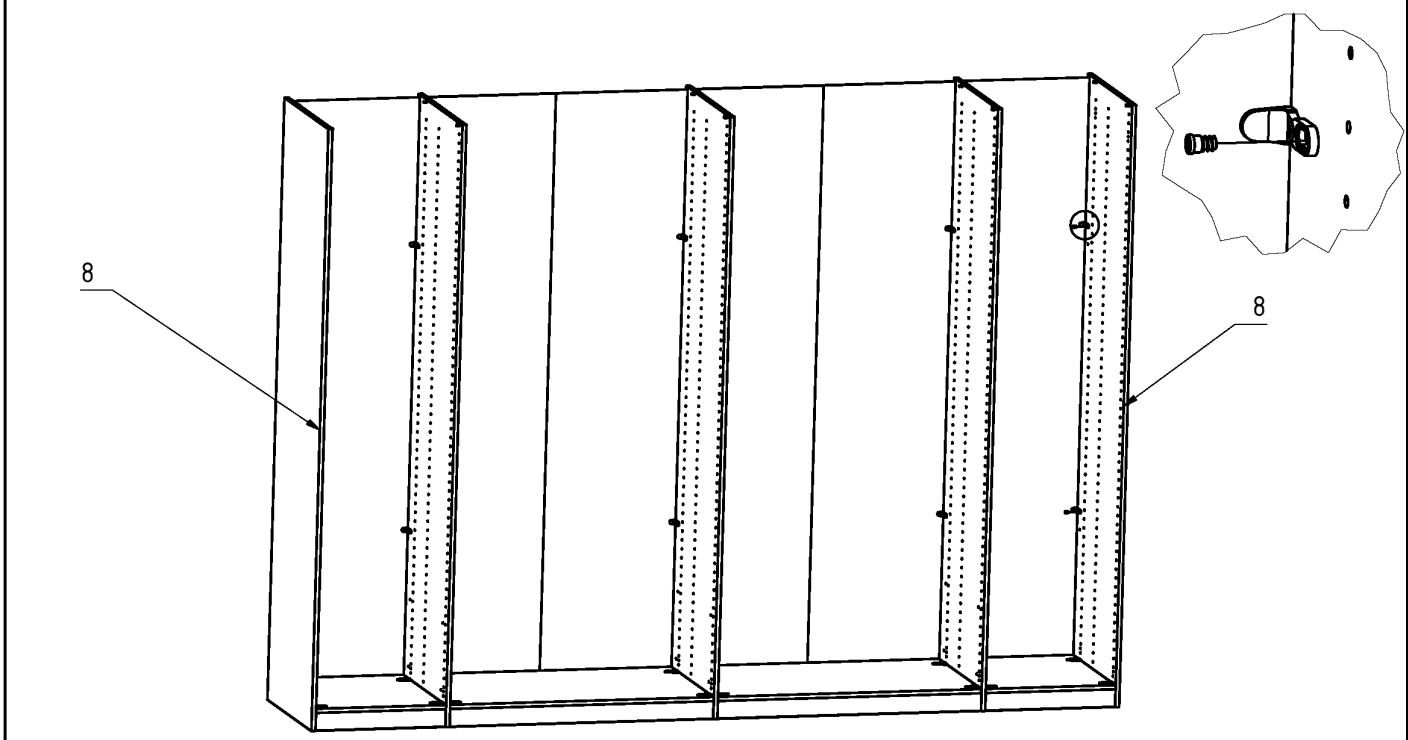
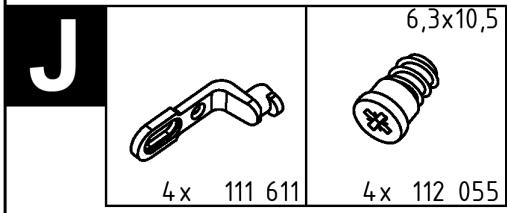
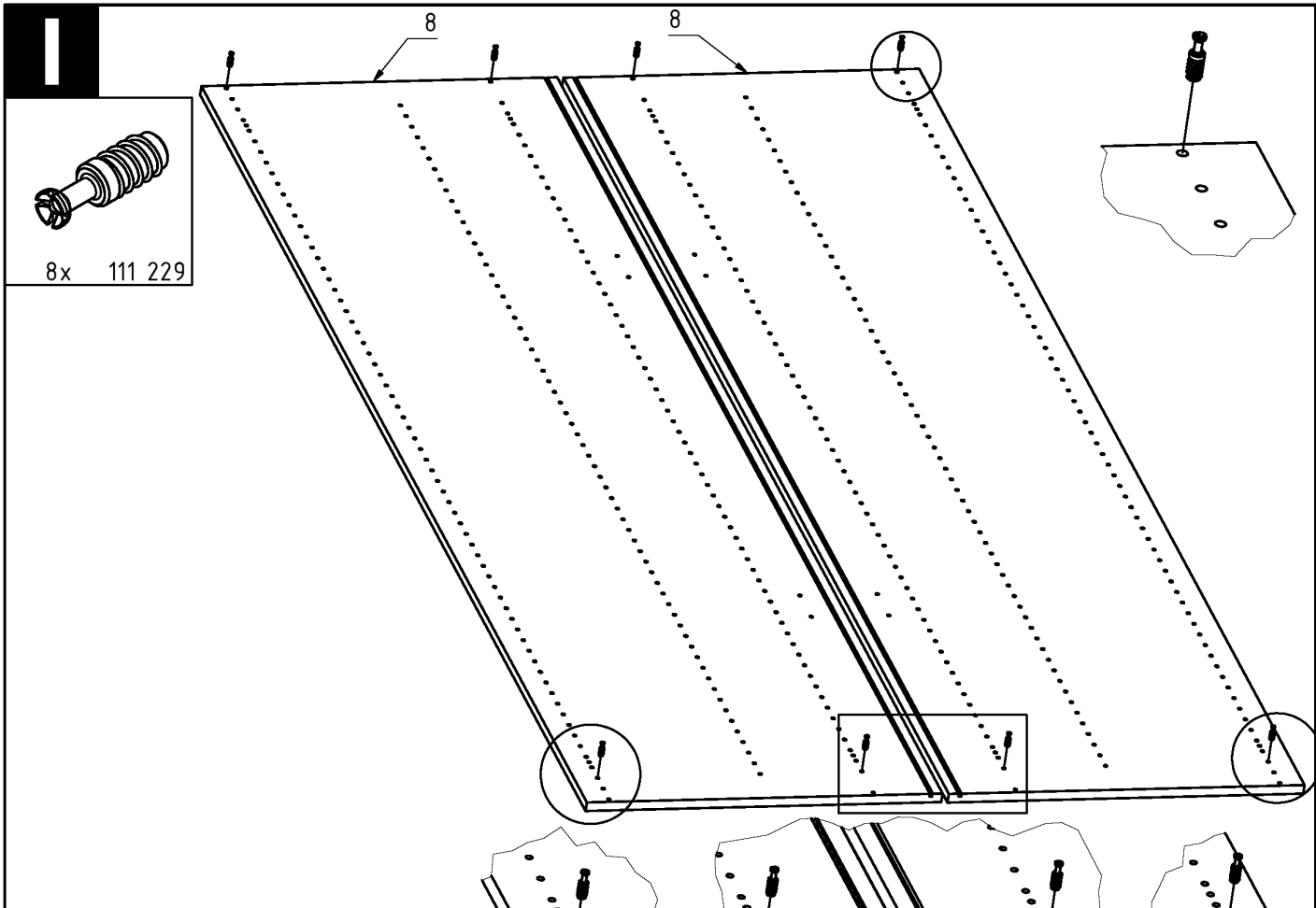

**K**

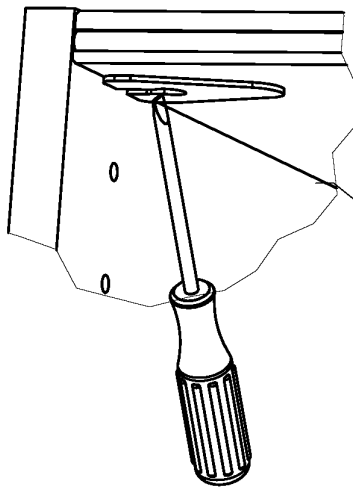

16x

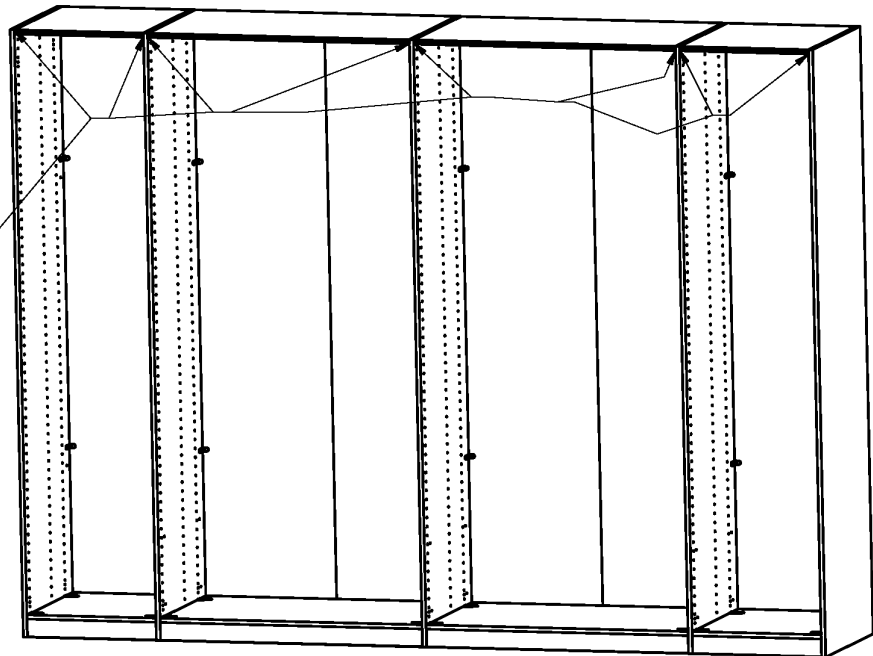

**L**

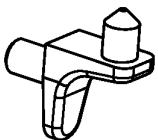

32x 111 610

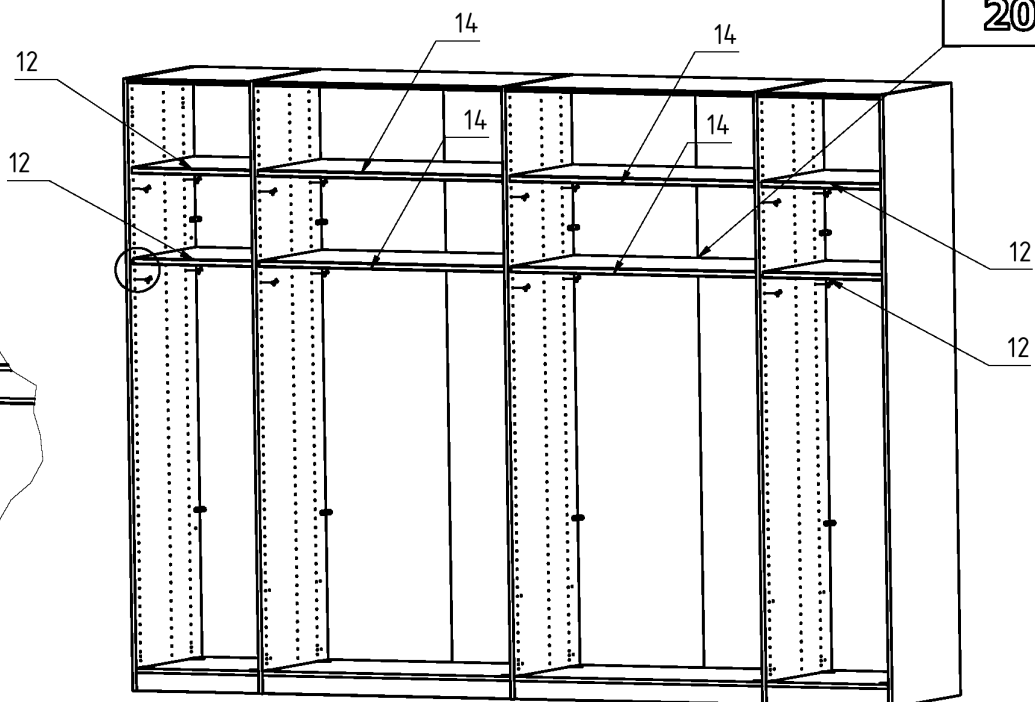

**M**

3,5x15



8x 121 370

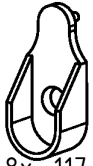

8x 117 002

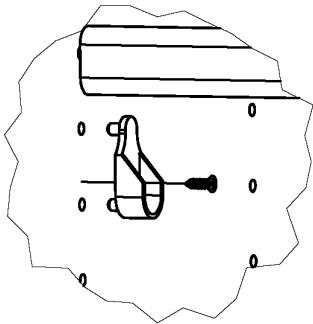
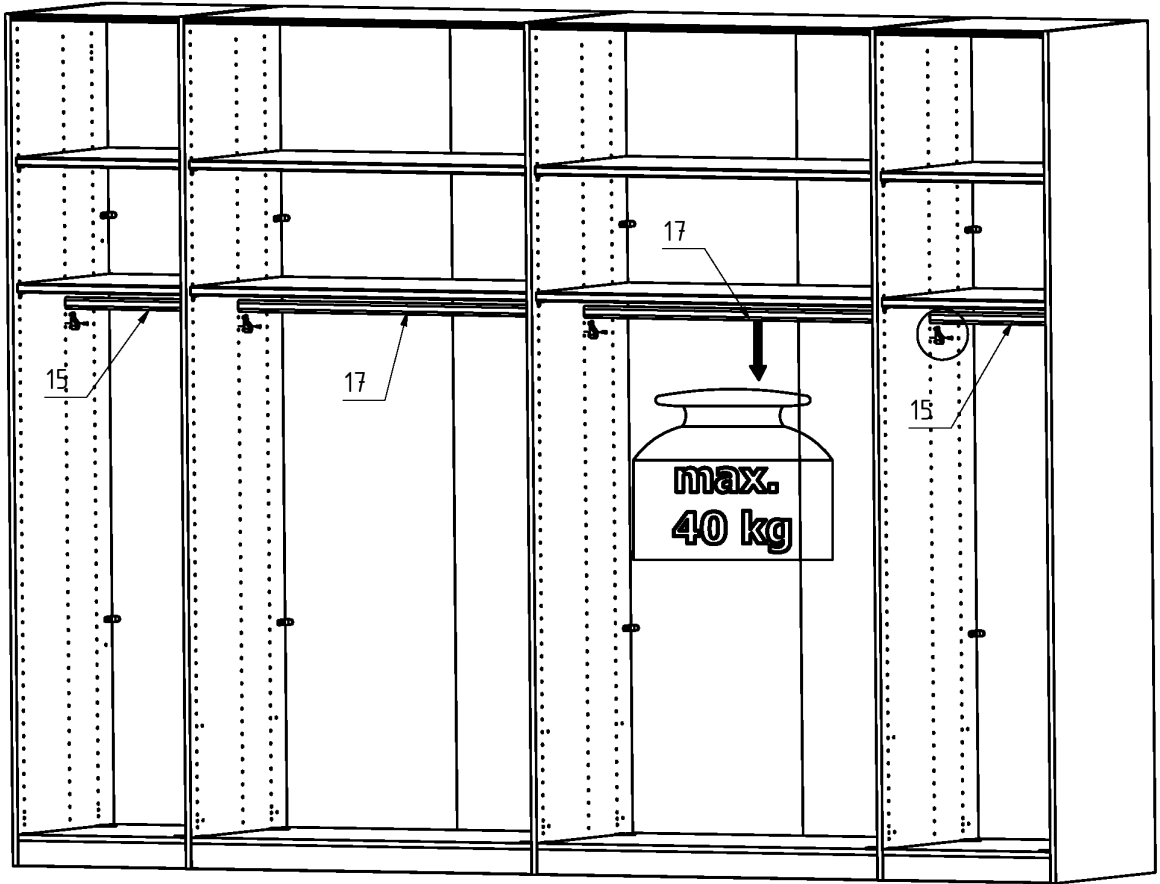

**N**

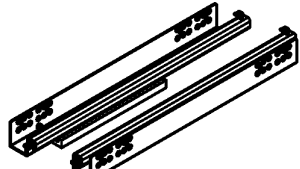

3x

112 521

6,3x11



12x 121 167

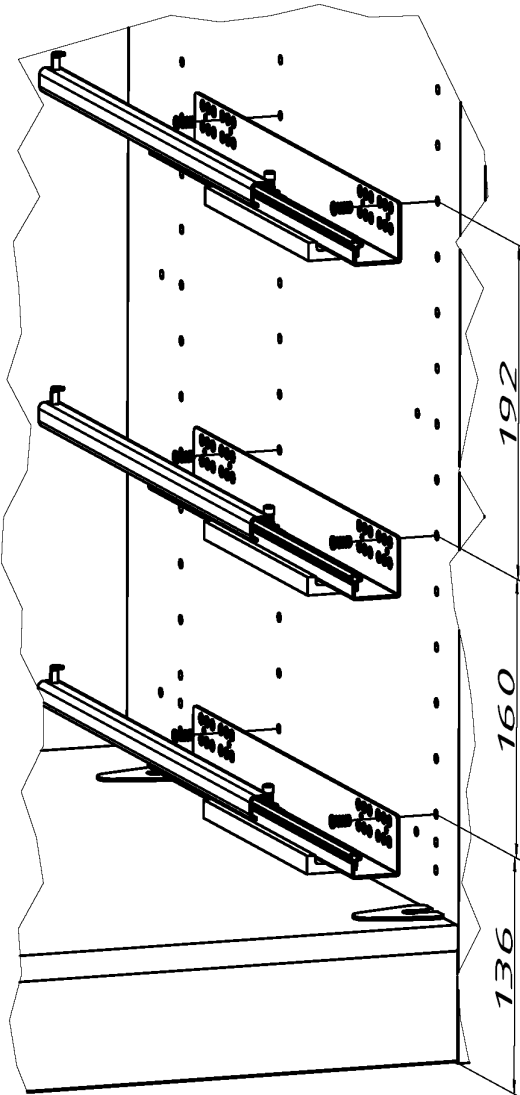
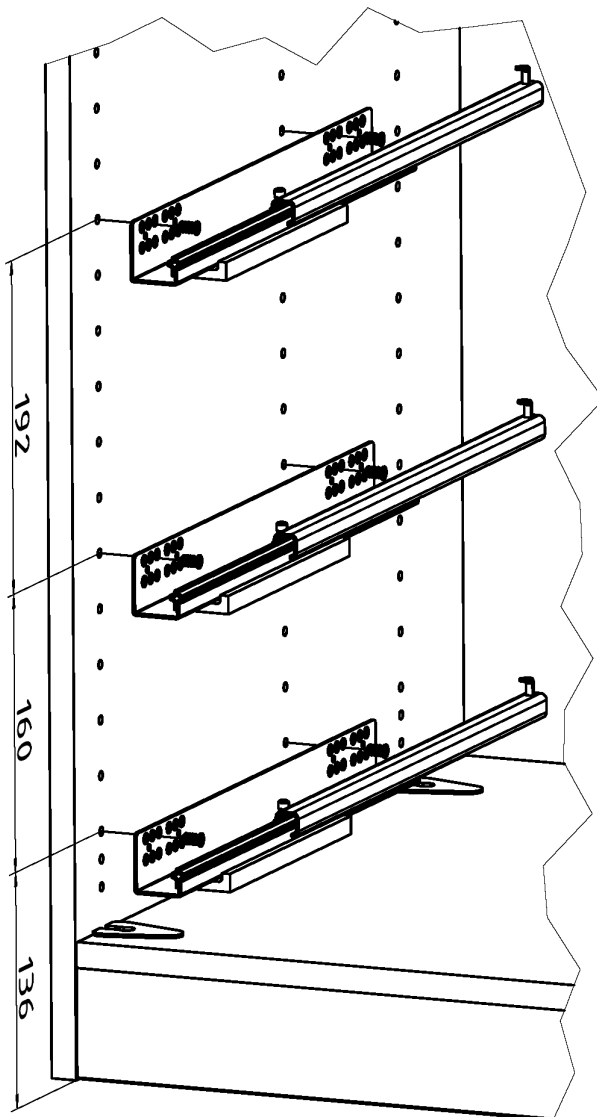
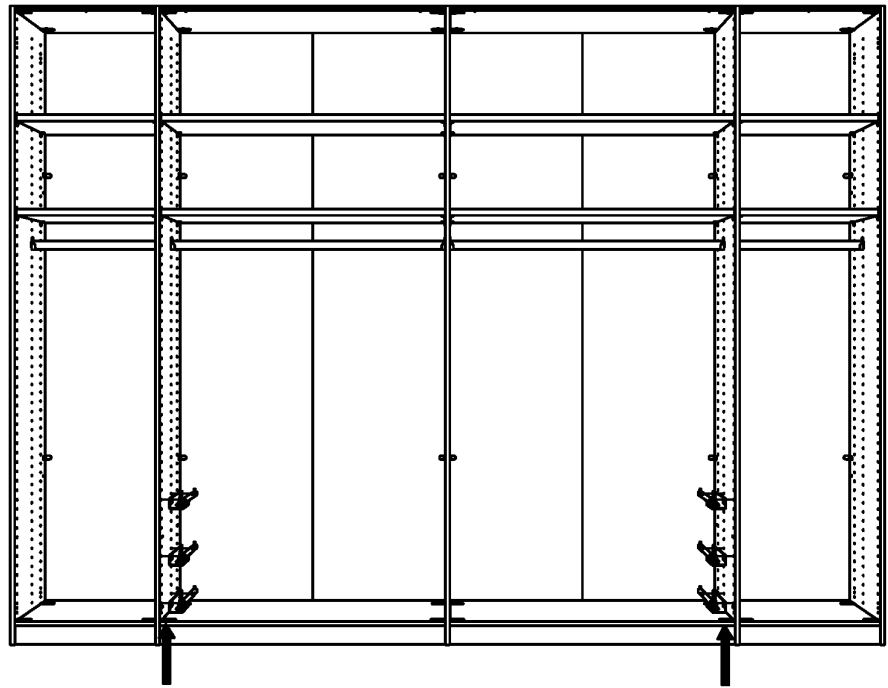
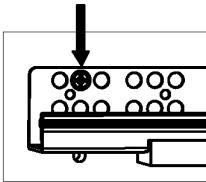

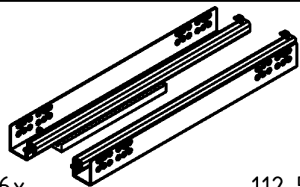

6x

112 521

M4

M4x7

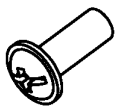

6x

113 809



6x

111014

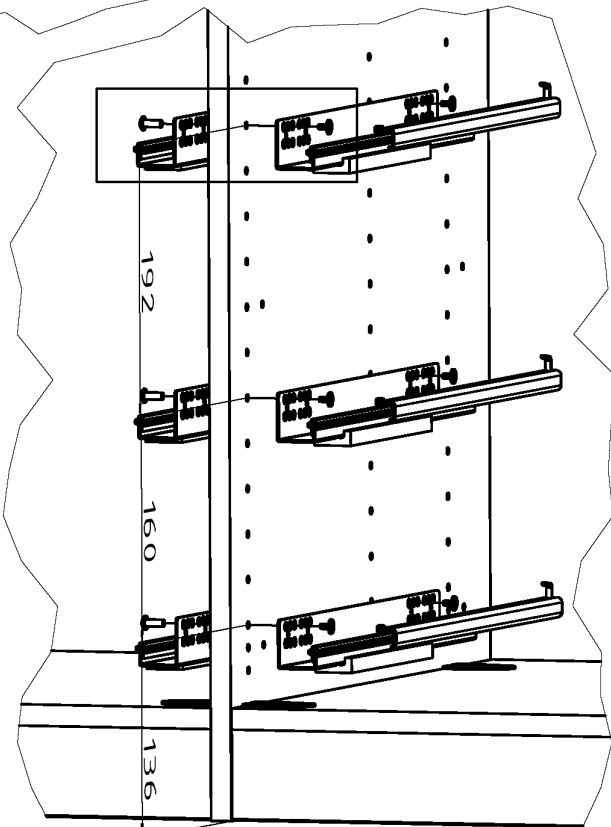
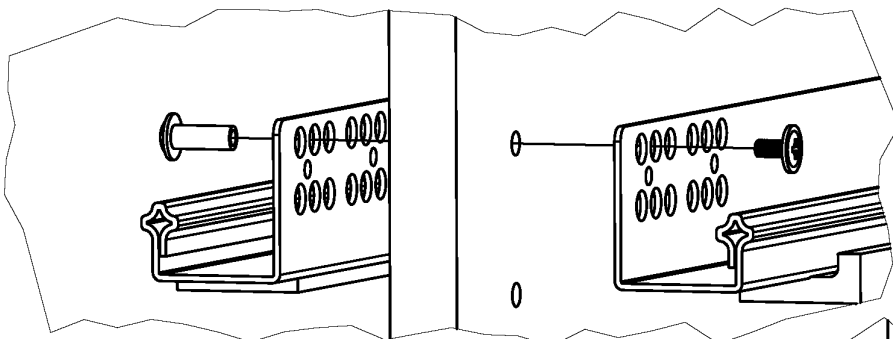
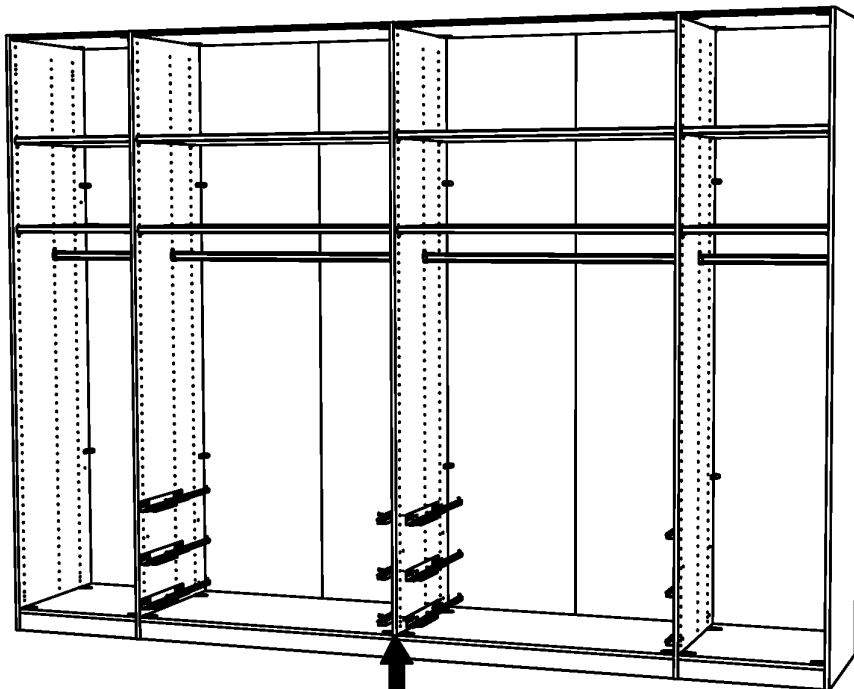

**P**

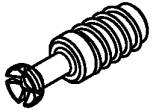

8x 111 229

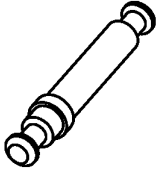

2x 111 235

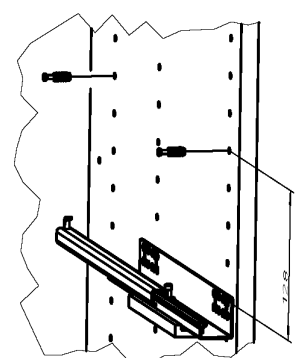
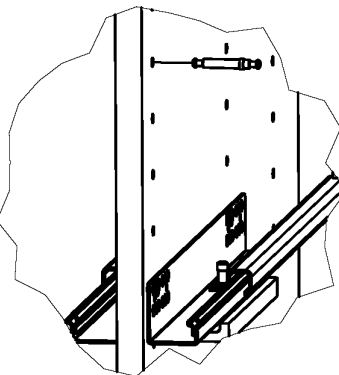
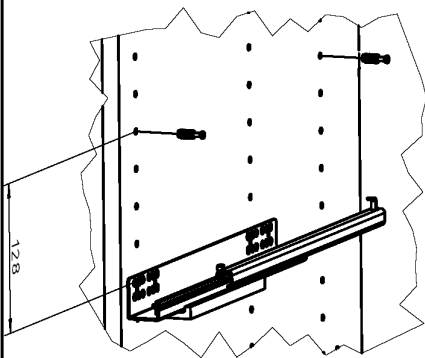
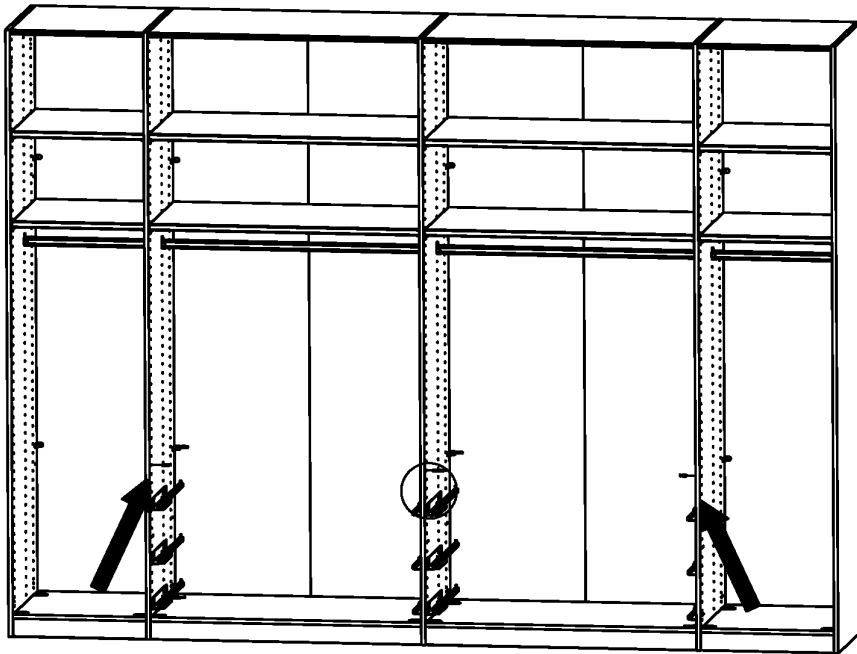

**Q**

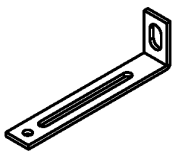

0-4x 111 036



0-4x 121 098

4,5x15



475 & 722 = 0x 111036  
964 = 4x 111036

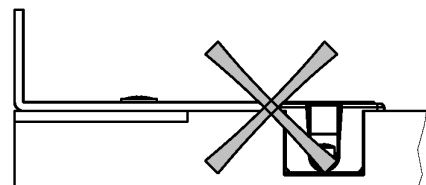
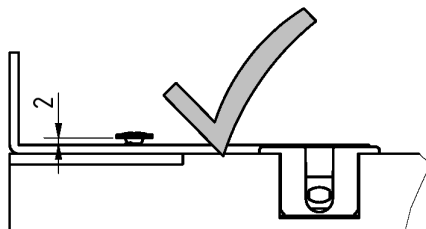
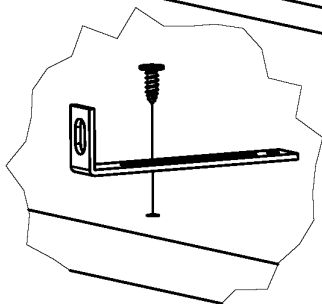
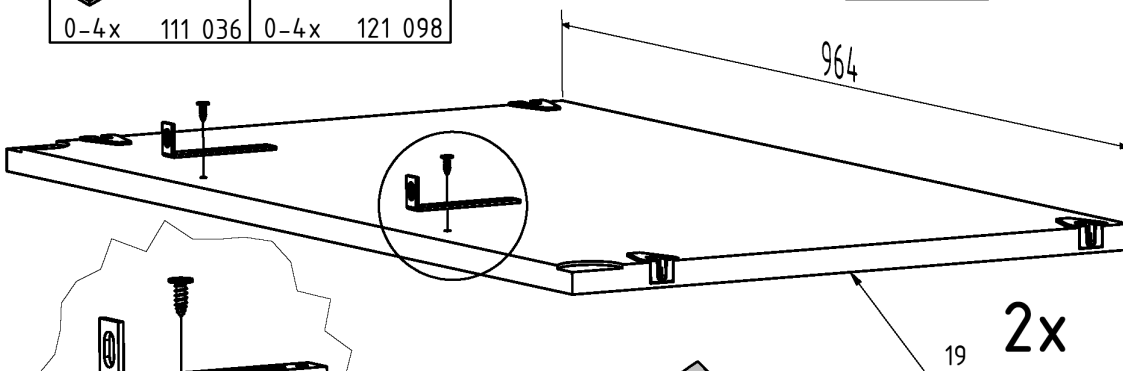

**R**

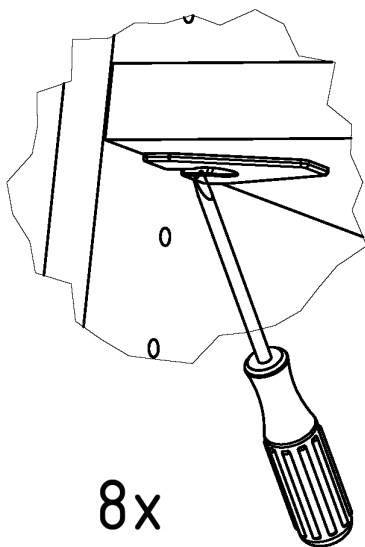

8x

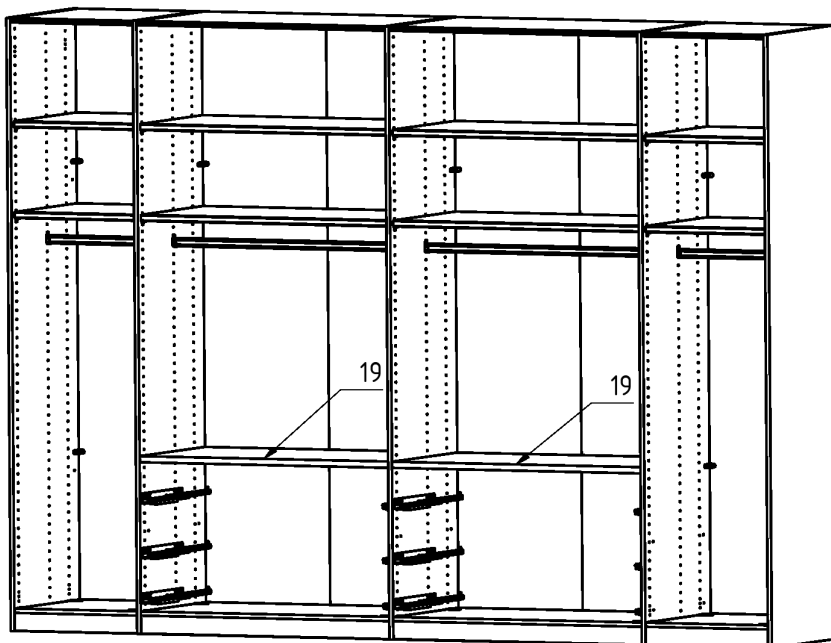

**S**

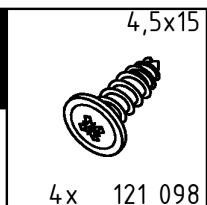

4x 121 098

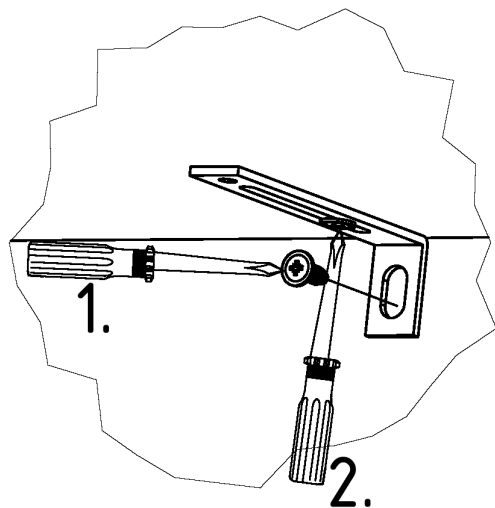
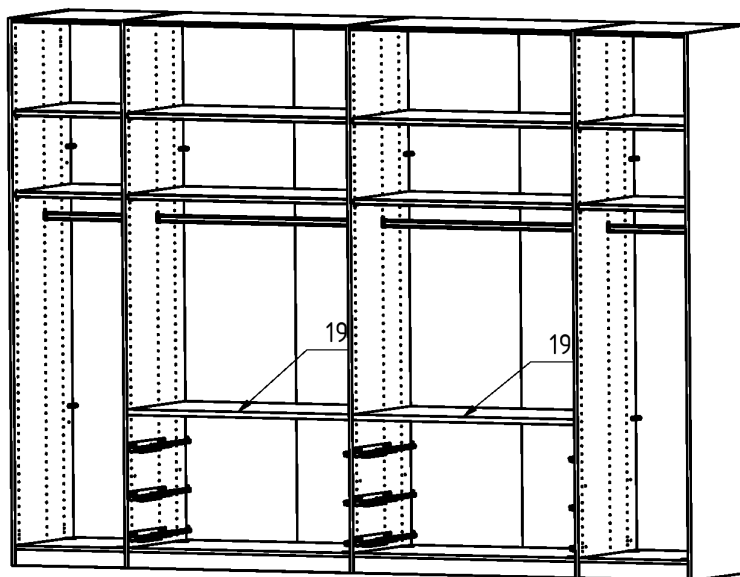

1.

2.

# T

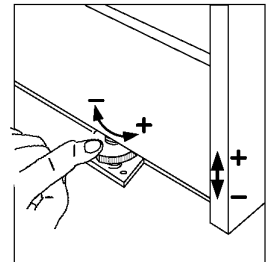
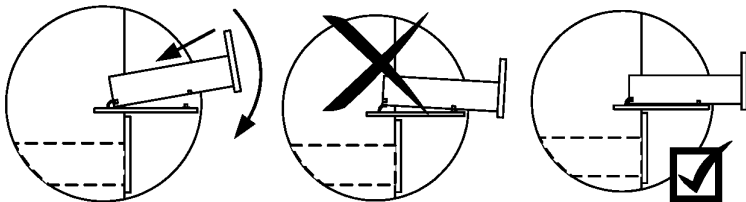
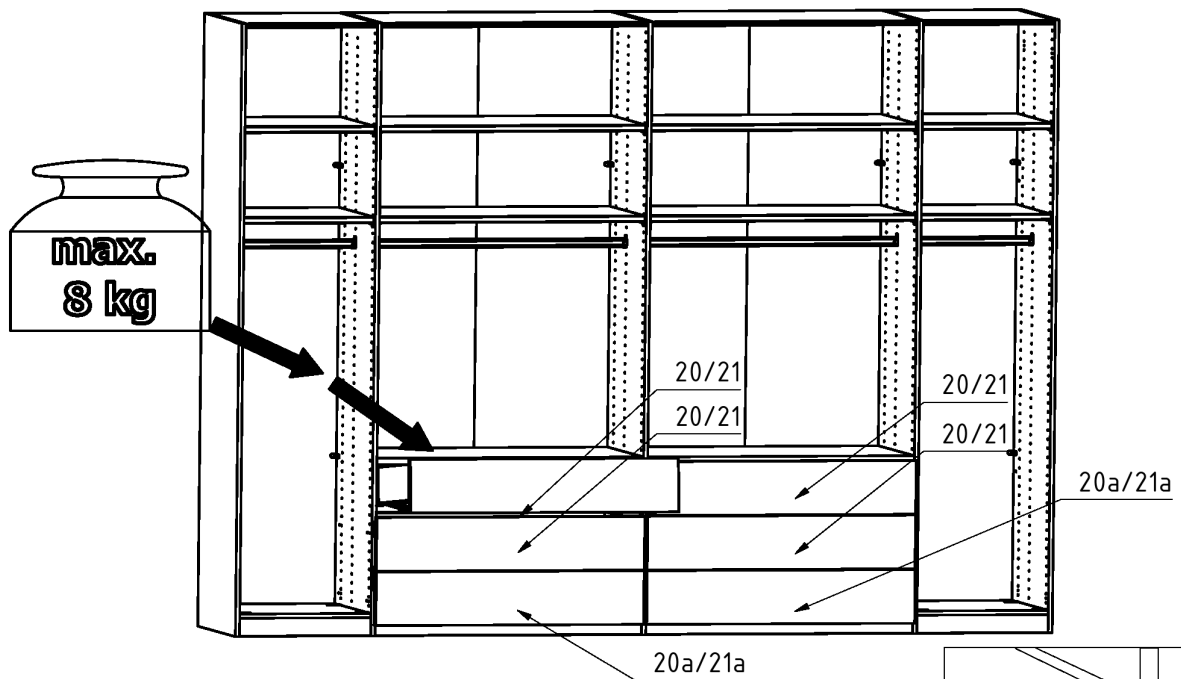

# U

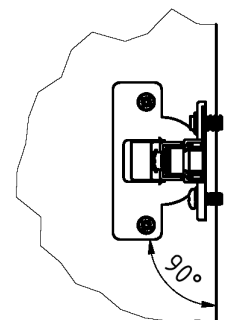
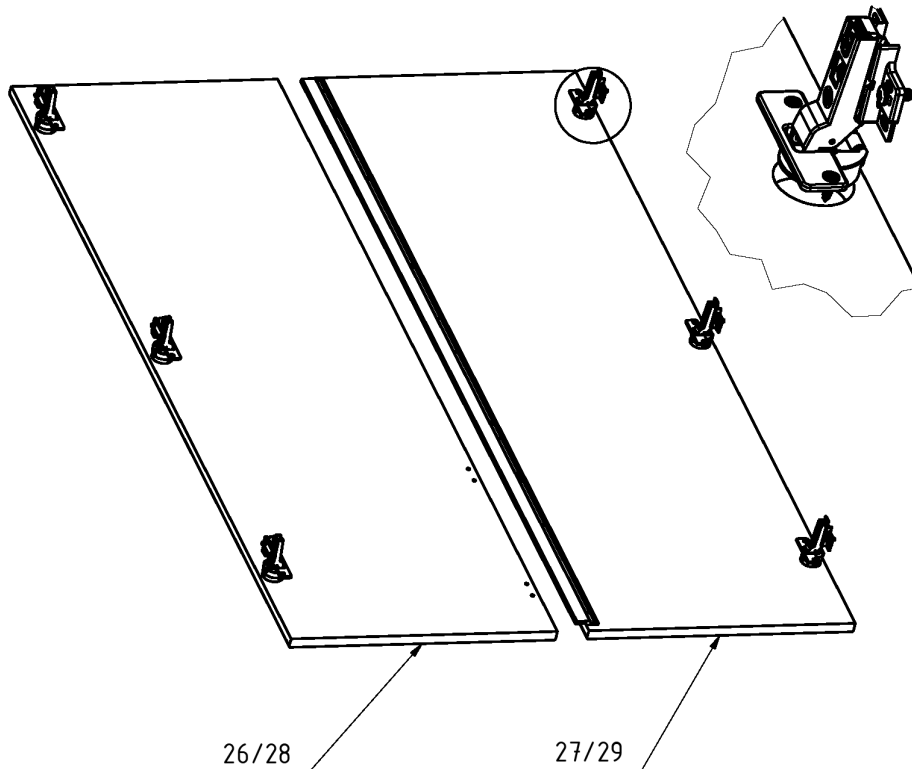
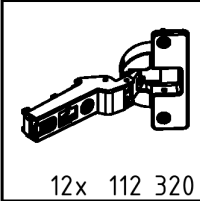
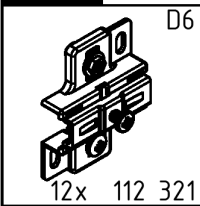

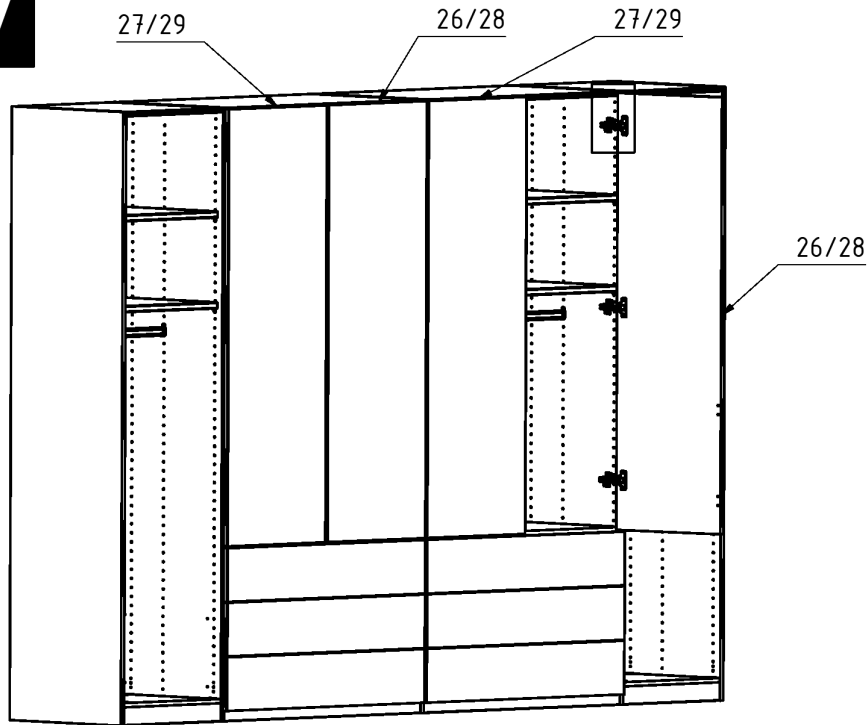
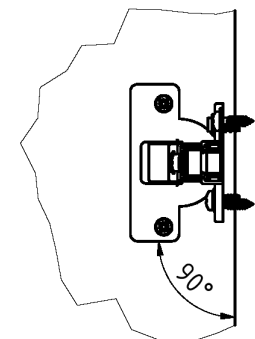
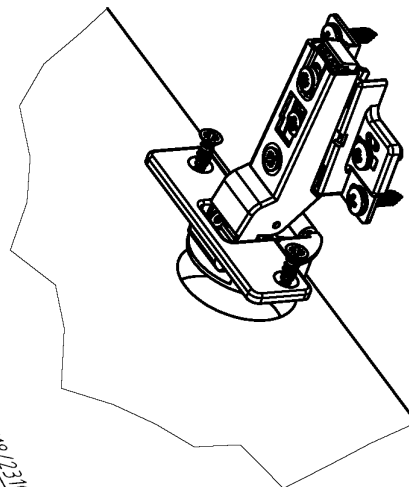
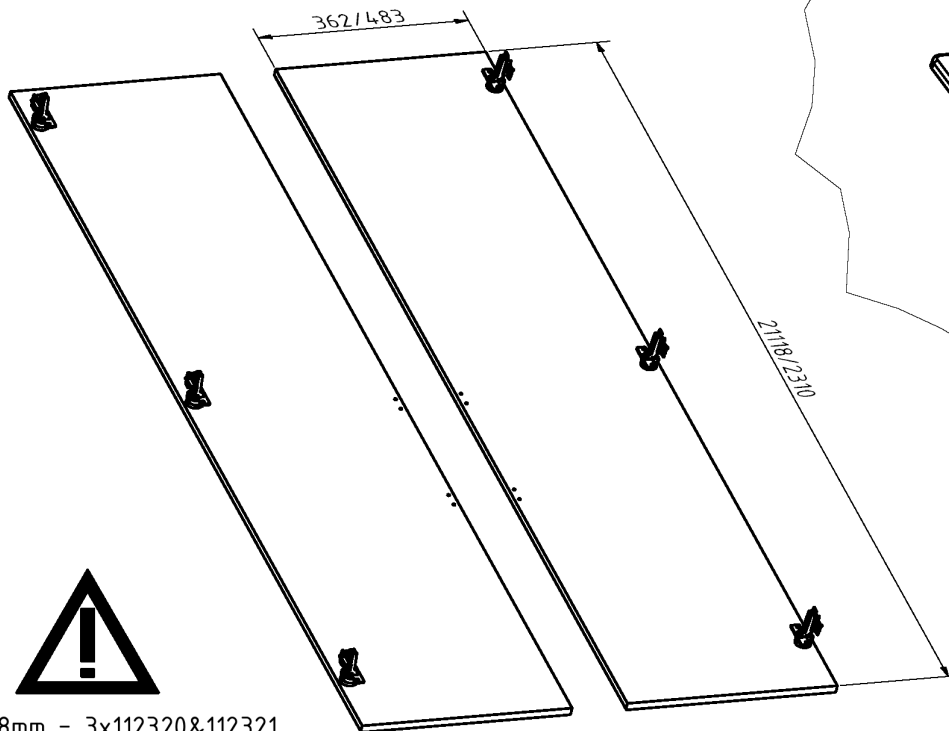
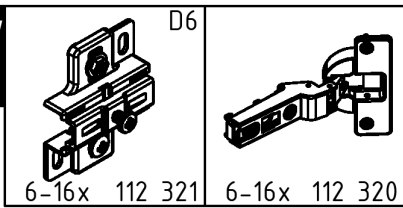

**V****W**

2118mm = 3x112320&112321  
 2310mm = 4x112320&112321

**X**

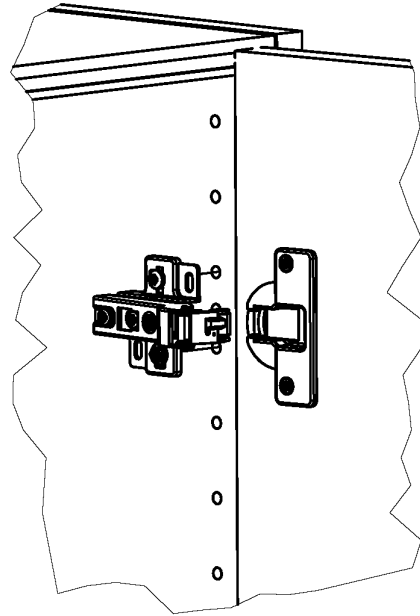
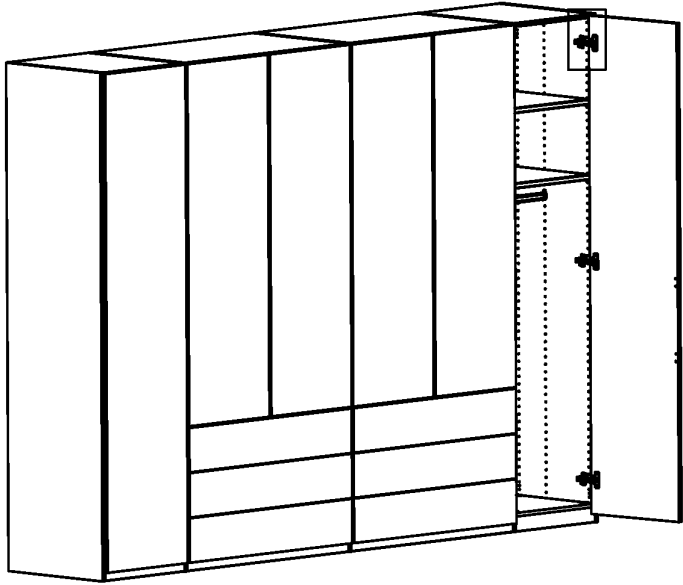

**Y**

4,0x14



24-48x 121 135

12-24x

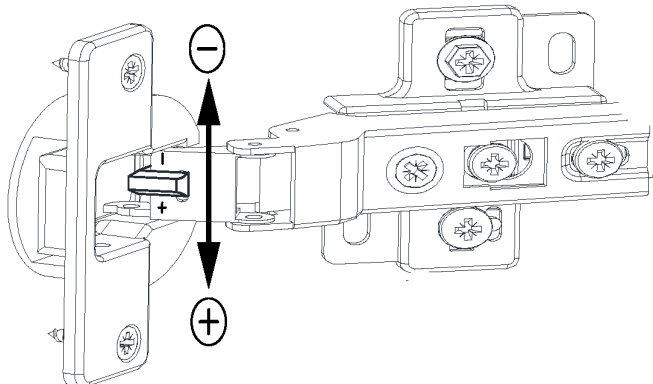
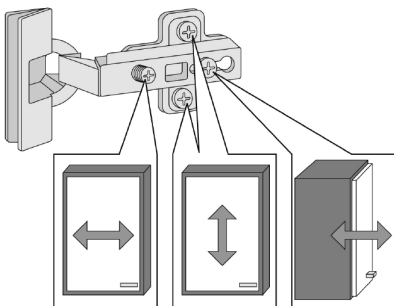
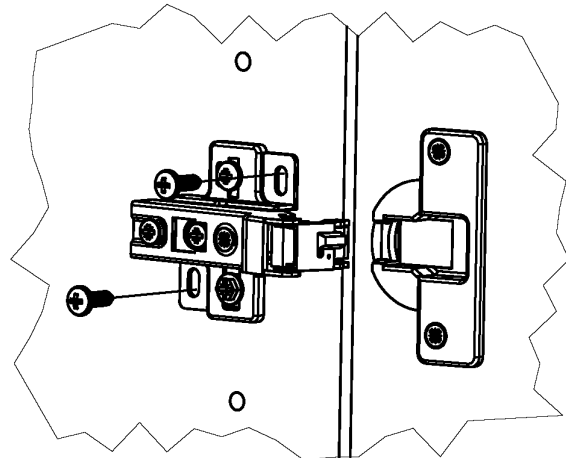
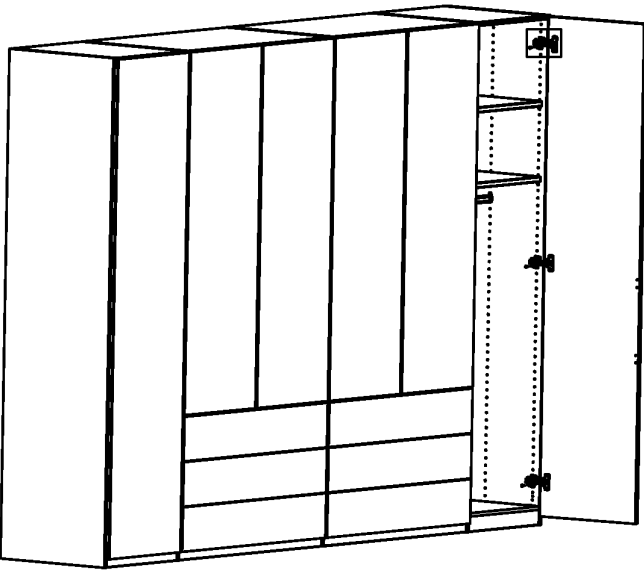

Z

3,5x15



12-16x 121 370

12-16x

