

Nr	Ausmaß			St
1	1172	380	15	1
2	1172	380	15	1
3	570	80	15	1
4	570	359	15	2
5	570	379	15	1
6	570	379	22	1
7	362	584	2	2
8	341	584	2	1

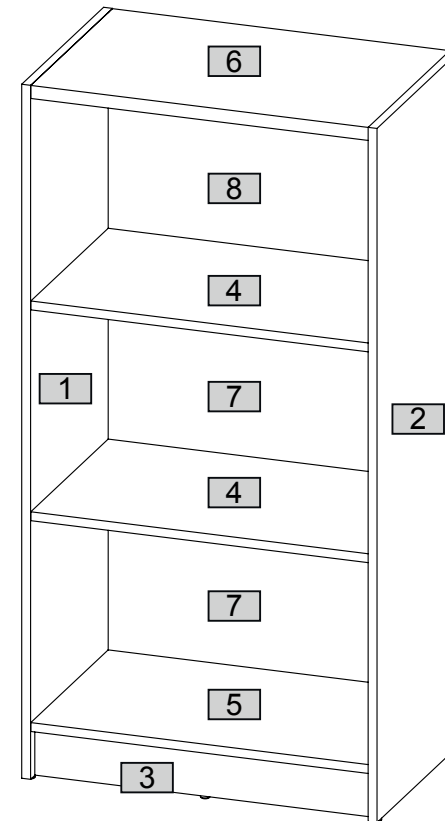

1

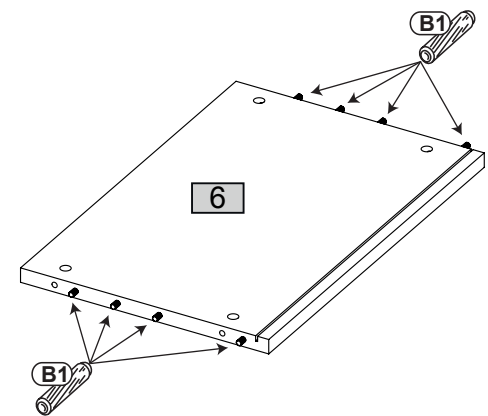
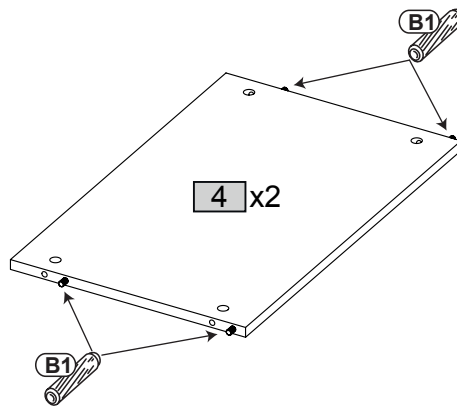
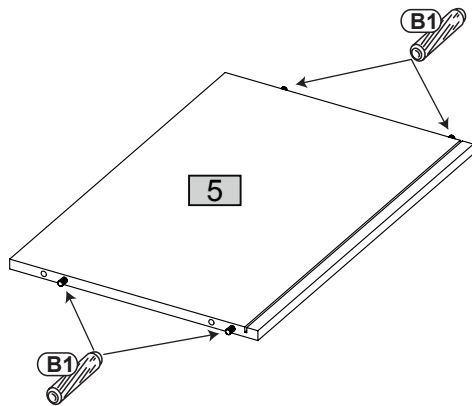
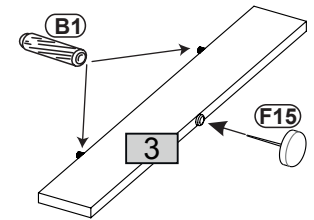
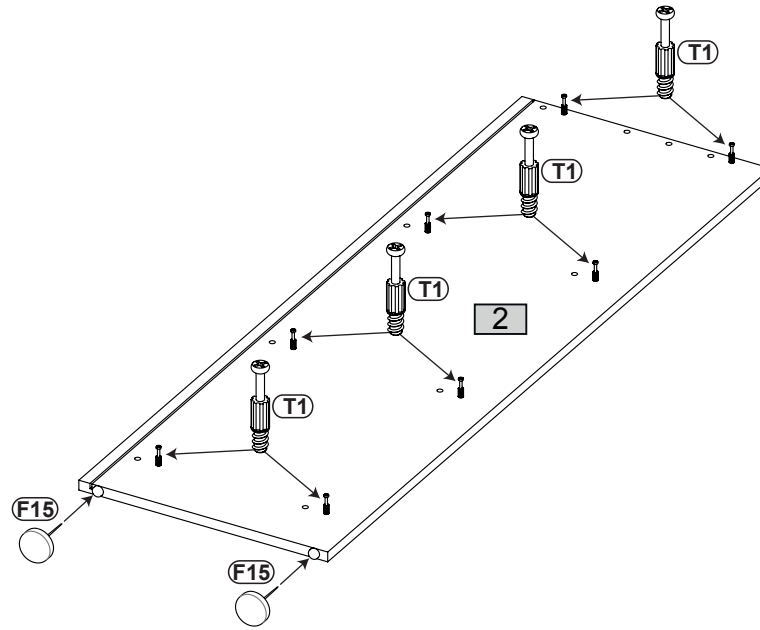
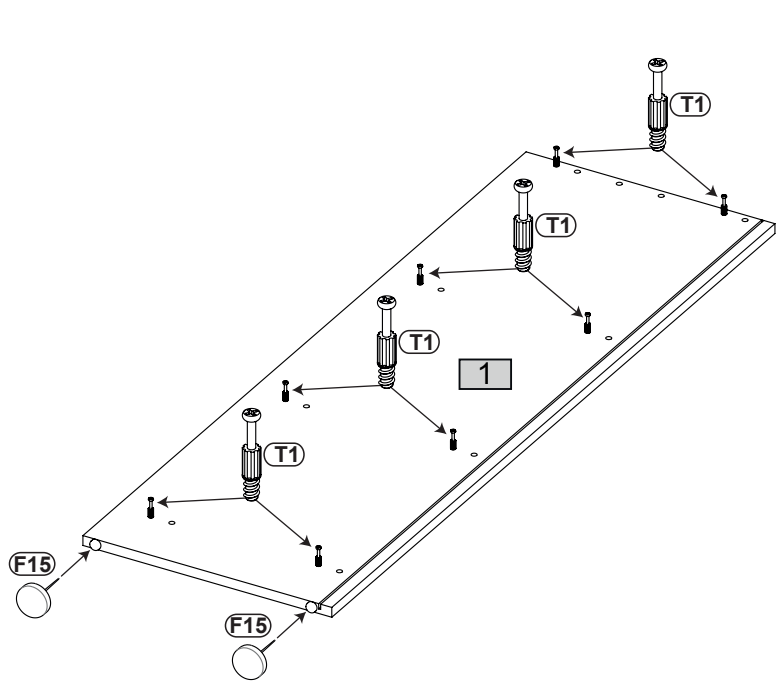
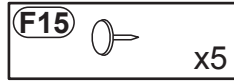
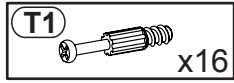
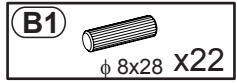

2

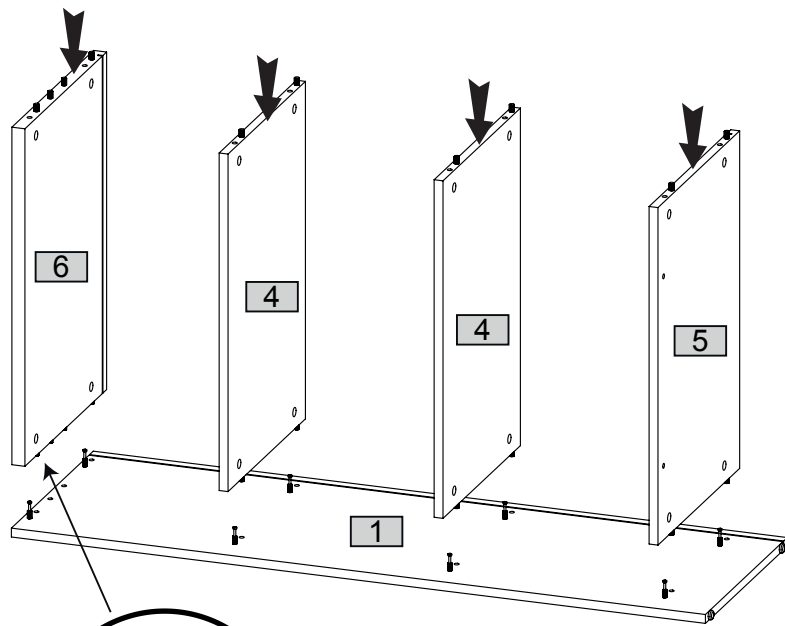

3

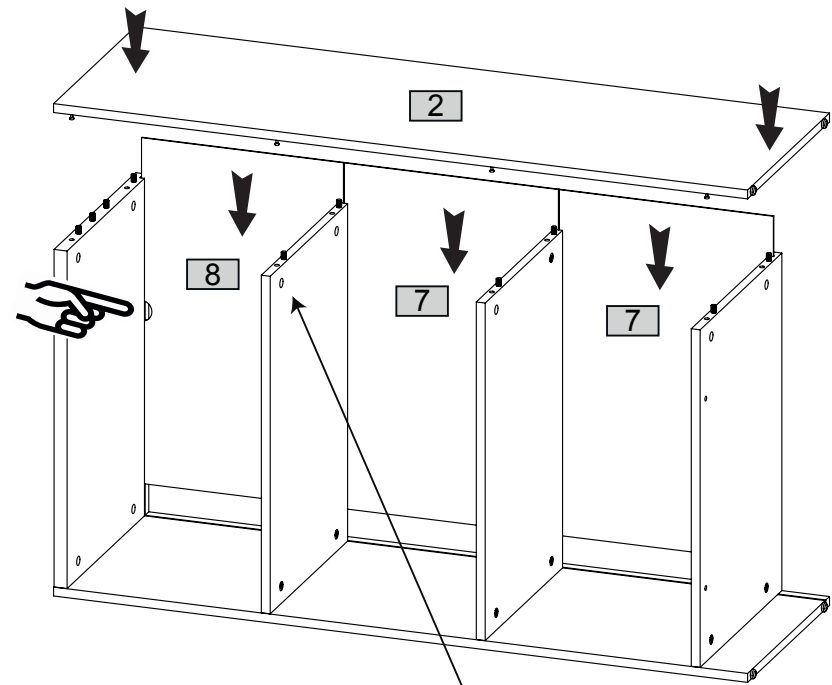

4

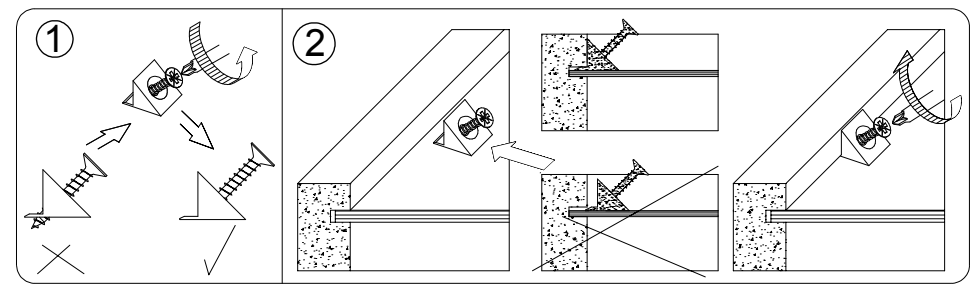
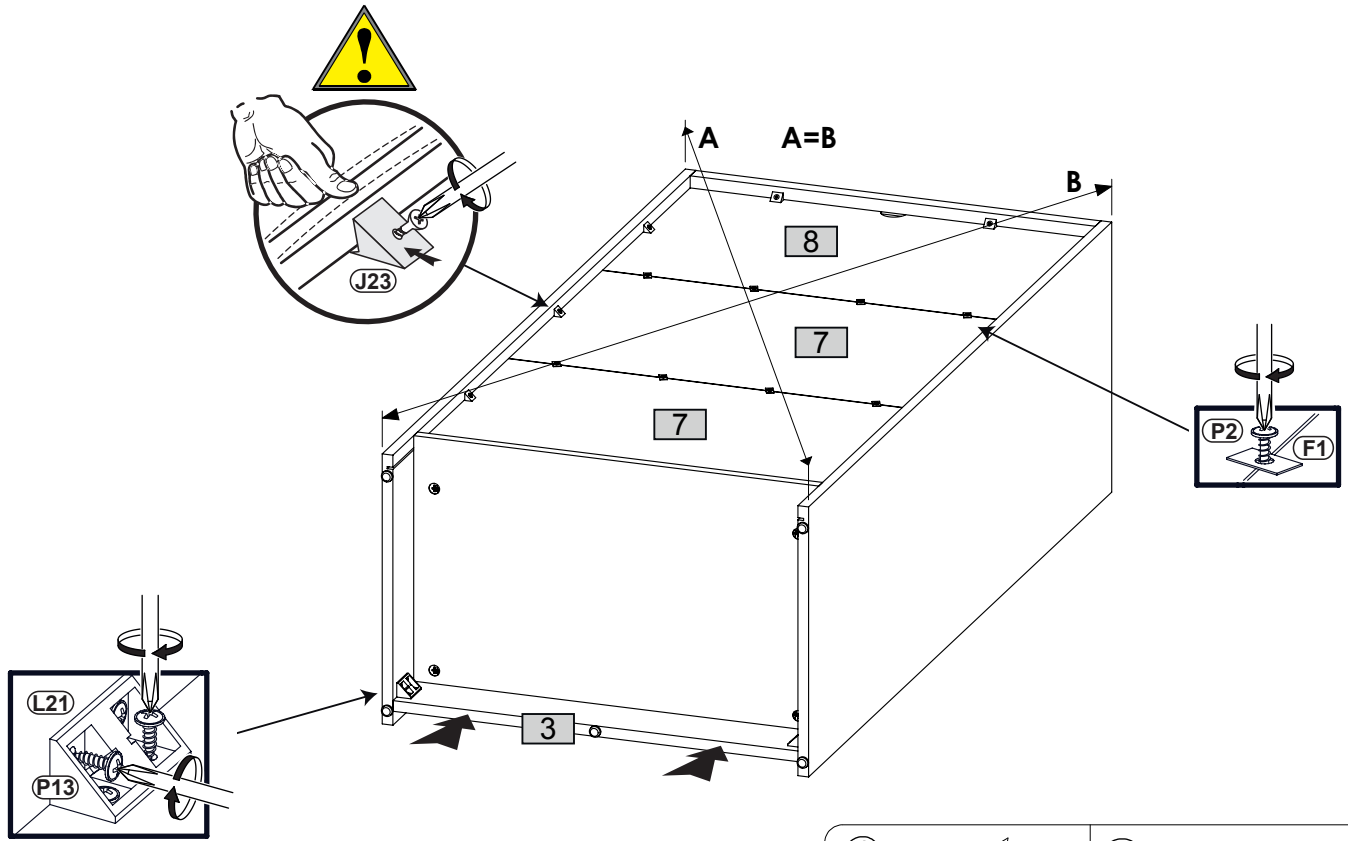
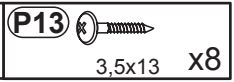
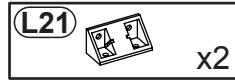
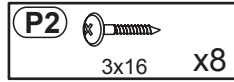
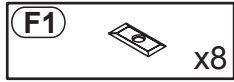
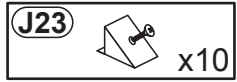

5

