

BEK435060B
EB40B

DA	Brugsanvisning Ovn	2
NL	Gebruiksaanwijzing Oven	29
EN	User Manual Oven	58
FI	Käyttöohje Uuni	86
FR	Notice d'utilisation Four	114
DE	Benutzerinformation Backofen	144
IT	Istruzioni per l'uso Forno	175
NO	Bruksanvisning Ovn	204
ES	Manual de instrucciones Horno	232
SV	Bruksanvisning Inbyggnadsugn	261

TIL PERFEKTE RESULTATER

Tak, fordi du valgte dette AEG-produkt. Vi har skabt det for at give dig upåklagelig ydeevne i mange år med innovative teknologier, som gør livet lettere – funktioner, som du måske ikke finder på almindelige apparater. Brug et par minutter på at læse mere – så du kan få det bedste ud af det.

Besøg vores hjemmeside for at:



Få rådgivning, brochurer, fejlfinding, service- og reparationsinformation:
www.aeg.com/support



Registrér dit produkt for at få bedre service:
www.registeraeg.com



Køb tilbehør, forbrugsvarer og originale reservedele til dit apparat:
www.aeg.com/shop

KUNDEPLEJE OG SERVICE

Brug altid originale reservedele.

Sørg for at have følgende data klar, når du kontakter vores autoriserede servicecenter:
Model, PNC, serienummer.

Oplysningerne findes på typeskiltet.

 Advarsel/forsigtig-sikkerhedsanvisninger

 Generelle oplysninger og råd

 Miljøoplysninger

Ret til ændringer uden varsel forbeholdes.

INDHOLDSFORTEGNELSE

1. OM SIKKERHED.....	3
2. SIKKERHEDSANVISNINGER.....	4
3. PRODUKTBESKRIVELSE.....	7
4. BETJENINGSPANEL.....	7
5. FØR FØRSTE ANVENDELSE.....	8
6. DAGLIG BRUG.....	8
7. URFUNKTIONER.....	10
8. BRUG AF TILBEHØRET.....	11
9. EKSTRAFUNKTIONER.....	12
10. RÅD OG TIPS.....	12
11. VEDLIGEHOLDELSE OG RENGØRING.....	24
12. FEJLFINDING.....	27
13. ENERGIEFFEKTIV.....	27
14. MILJØHENSYN.....	28

1. ⚠️ OM SIKKERHED

Læs brugsanvisningen grundigt, før apparatet installeres og tages i brug. Producenten påtager sig intet ansvar for eventuelle skader, der er resultatet af forkert installation eller brug. Opbevar altid brugsanvisningen på et sikkert og tilgængeligt sted til senere opslag.

1.1 Sikkerhed for børn og sårbare personer

- Apparatet må kun bruges af børn fra 8 år og opefter samt af personer med nedsat fysisk, sensorisk eller psykisk funktionsevne, eller som mangler den nødvendige erfaring eller viden, hvis de er under opsyn eller er blevet instrueret i at bruge apparatet på en sikker måde samt forstår de farer, det indebærer. Børn under 8 år og personer med omfattende og komplekst handicap skal holdes på afstand af apparatet, medmindre de overvåges konstant.
- Børn skal holdes under opsyn for at sikre, at de ikke leger med apparatet.
- Opbevar al emballage utilgængeligt for børn, og bortskaf det korrekt.
- ADVARSEL: Ovnen og de tilgængelige dele bliver meget varme under brug. Lad ikke børn og husdyr komme tæt på apparatet, mens det er i brug, eller når det køler af.
- Hvis apparatet har en børnesikring, skal den aktiveres.
- Børn må ikke udføre rengøring og vedligeholdelse på produktet uden opsyn.

1.2 Generel sikkerhed

- Dette apparat må kun anvendes til tilberedning af fødevarer.
- Dette apparat er beregnet til indendørs husholdningsbrug.
- Dette apparat kan bruges på kontorer, hotelværelser, bed & breakfast-værelser, stue- og gæstehuse og anden lignende indkvartering, hvor en sådan brug ikke overstiger (gennemsnitlig) brugsniveauer i hjemmet.

- Kun en faguddannet installatør må installere apparatet og udskifte kablet.
- Brug ikke apparatet, inden det monteres i den indbyggede struktur.
- Før enhver vedligeholdelse skal apparatet kobles fra elnettet.
- Hvis strømledningen er beskadiget, skal den af sikkerhedsgrunde udskiftes af producenten, det autoriserede servicecenter eller en tekniker med tilsvarende kvalifikationer.
- ADVARSEL: Sørg for, at der er slukket for apparatet, inden pæren skiftes for at undgå elektrisk stød.
- ADVARSEL: Ovnen og de tilgængelige dele bliver meget varme under brug. Vær omhyggelig med at undgå at røre ved varmeelementer eller ovnrummets overflade.
- Brug altid ovnhandsker til at fjerne eller isætte tilbehør eller ovnartikler.
- Træk først ovnribberne og derefter den bageste ende væk fra sidevæggene for at fjerne ovnribberne. Montér ovnribberne i modsat rækkefølge.
- Brug ikke damprensere til at rengøre apparatet.
- Brug ikke skrappe slibende rengøringsmidler eller skarpe metalskrabere til at rengøre glasset i kogesektionens hængslede låg. De kan ridse overfladen, med det resultat, at glasset knuses.

2. SIKKERHEDSANVISNINGER

2.1 Installation

ADVARSEL!

Apparatet må kun installeres af en sagkyndig.

- Fjern al emballagen.
- Undlad at installere eller bruge et beskadiget apparat.
- Følg installationsvejledningen, der følger med apparatet.
- Vær altid forsigtig, når du flytter apparatet, da det er tungt. Brug altid sikkerhedshandsker og lukket fodtøj.
- Træk aldrig i apparatet i håndtaget.
- Installér apparatet et sikkert og velegnet sted, der opfylder installationskrav.
- Mindsteafstanden til andre apparater og enheder skal overholdes.
- Før du monterer ovnen, skal du kontrollere, om ovnlågen åbner uden modstand.

- Apparatet er udstyret med et elektrisk afkølingssystem. Det skal betjenes med den elektriske strømforsyning.
- Indbygningsskabets stabilitet skal opfylde kravene i DIN 68930.

Kabinettets minimumshøjde (kabinets minimumshøjde under bordpladen)	578 (600) mm
Kabinet, bredde	560 mm
Kabinet, dybde	550 (550) mm
Højde foran på apparatet	594 mm
Højde bagest på apparatet	576 mm
Bredde foran på apparatet	595 mm
Bredde bagest på apparatet	559 mm
Apparatets dybde	567 mm
Apparatets indbygningsdybde	546 mm
Dybde med åben dør	1027 mm
Ventilationsåbning minimumsstørrelse. Åbning placeret på bundens bageste side	560x20 mm
Længden på ledninger til strømforsyning. Ledning placeret i højre hjørne af bagsiden	1500 mm
Monteringsskruer	4x25 mm

2.2 El-forbindelse

ADVARSEL!

Risiko for brand og elektrisk stød.

- Alle elektriske tilslutninger skal udføres af en kvalificeret elektriker.
- Apparatet skal tilsluttes strøm m/jord, jvf. Stærkstrømsreglementet.
- Sørg for, at parametrene på typeskiltet er kompatible med nettilslutningens elektriske mærkeværdier.
- Brug altid en korrekt monteret lovlig stikkontakt.
- Brug ikke multistikadaptere og forlængerledninger.
- Pas på, du ikke beskadiger netstikket og netledningen. Hvis der bliver behov for at

udskifte netledningen, skal det udføres af vores autoriserede servicecenter.

- Elledninger må ikke komme i berøring med eller nær ved apparatets låge, især når det er tændt, eller lågen er varm.
- Beskyttelsen mod elektrisk stød fra strømførende og isolerede dele skal fastgøres, så den ikke kan fjernes uden værktøj.
- Sæt først netstikket i stikkontakten ved installationens afslutning. Sørg for, at der er adgang til elstikket efter installationen.
- Hvis stikkontakten er løs, må du ikke sætte netstikket i.
- Undgå at slukke for apparatet ved at trække i netledningen. Tag altid selve netstikket ud af kontakten.
- Brug kun korrekte isoleringsenheder: Gruppeafbrydere, sikringer (sikringer med skruegevind skal tages ud af fatningen), fejlstrømsrelæer og kontaktorer.
- Apparatets installation skal udføres med et isolationsudstyr, så forbindelsen til lysnettet kan afbrydes på alle poler. Isolationsudstyret skal have en brydeafstand på mindst 3 mm.
- Dette apparat er forsynet med et stik og en strømledning.

2.3 Brug

ADVARSEL!

Risiko for personskade, forbrændinger og elektrisk stød eller eksplosion.

- Apparatets specifikationer må ikke ændres.
- Sørg for, at ventilationsåbningerne ikke er blokerede.
- Lad ikke apparatet være uden opsyn under drift.
- Sluk for apparatet efter hver brug.
- Vær forsigtig, når du åbner apparatets låge, hvis apparatet er i brug. Der kan slippe varm luft ud.
- Betjen ikke apparatet med våde hænder, eller når det har kontakt med vand.
- Tryk ikke på den åbne låge.
- Brug ikke apparatet som arbejds- eller frasætningsplads.
- Åbn apparatets låge forsigtigt. Brug af ingredienser med alkohol kan forårsage en blanding af alkohol og luft.

- Lad ikke gnister eller åben ild komme i kontakt med apparatet, når du åbner lågen.
- Læg ikke brændbare produkter eller genstande, der er våde med brændbare produkter i nærheden af eller på apparatet.

⚠ ADVARSEL!

Risiko for beskadigelse af apparatet.

- Sådan undgås skader eller misfarvning af emaljen:
 - Stil ikke ovnfaste fade eller andre genstande direkte i apparatet.
 - Læg ikke aluminiumsfolie direkte på bunden af ovnrummet.
 - Hæld ikke vand direkte ind i det varme apparat.
 - Hold ikke fugtige fade og madvarer i apparatet, når du har afsluttet tilberedningen.
 - Vær forsigtig, når du fjerner eller monterer tilbehøret.
- Farveændring af emaljen eller rustfrit stål forringer ikke apparatets ydeevne.
- Brug en brædepande til fugtige kager.
- Frugtsaft forårsager pletter, der kan være permanente.
- Tilbered altid mad med lågen lukket.
- Hvis apparatet installeres bag et møbelpanel (f.eks. en dør), skal du sørge for, at døren aldrig lukkes, mens apparatet er tændt. Der kan opbygges varme og fugt bag et lukket møbelpanel, hvilket kan forårsage efterfølgende skade på apparatet, huset eller gulvet. Luk ikke møbelpanelet, før apparatet er kølet helt af efter brug.

2.4 Vedligeholdelse og rengøring

⚠ ADVARSEL!

Risiko for personskade, brand eller skade på apparatet.

- Sluk for apparatet, og tag stikket ud af kontakten inden vedligeholdelse.
- Kontrollér, at apparatet er kølet af. Der er risiko for, at ovnglasset går i stykker.
- Udskift øjeblikkeligt ovnglassets paneler, hvis de er beskadigede. Kontakt det autoriserede servicecenter.

- Vær forsigtig, når du tager lågen af apparatet. Døren er tung!
- Rengør jævnlige apparatet for at forhindre forringelse af overfladematerialet.
- Rengør apparatet med en fugtig, blød klud. Brug kun neutrale rengøringsmidler. Brug ikke slibende midler, skuresvampe, opløsningsmidler eller metalgenstande.
- Hvis du bruger en ovnspray, skal du følge instruktionerne på dens emballage.

2.5 Indvendig belysning

⚠ ADVARSEL!

Risiko for elektrisk stød.

- Vedrørende lampe(r) i dette produkt og reservedelslamper, der sælges separat: Disse lamper er beregnet til at modstå ekstreme fysiske forhold i husholdningsapparater, såsom temperatur, vibration, fugt, eller er beregnet til at signalere information om apparatets driftsstatus. De er ikke beregnet til at blive brugt i andre apparater, og de er ikke velegnede til belysning af rum.
- Dette produkt indeholder en lyskilde i energieffektivitetsklasse G.
- Brug kun lamper med de samme specifikationer.

2.6 Service

- Kontakt det autoriserede servicecenter for at få repareret apparatet.
- Brug kun originale reservedele.

2.7 Bortskaffelse

⚠ ADVARSEL!

Risiko for personskade eller kvælning.

- Kontakt din genbrugsplads ang. oplysninger om, hvordan produktet bortskaffes korrekt.
- Tag stikket ud af kontakten.
- Klip netledningen af tæt ved apparatet og bortskaf den.
- Fjern lågelåsen for at forhindre, at børn eller kæledyr bliver fanget i apparatet.

3. PRODUKTBESKRIVELSE

3.1 Generelt overblik

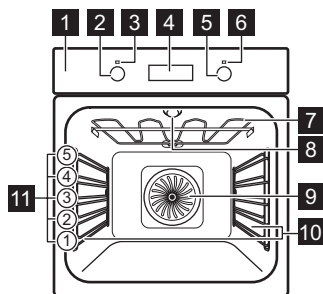

- 1 Betjeningspanel
- 2 Knap til ovnfunktioner
- 3 Strømindikator/-symbol
- 4 Display
- 5 Betjeningsknap (til temperatur)
- 6 Temperaturindikator/-symbol
- 7 Varmelegeme
- 8 Ovnprære
- 9 Blæser
- 10 Ovnribbe, udtagelig
- 11 Ovnriller

3.2 Tilbehør

Grillrist

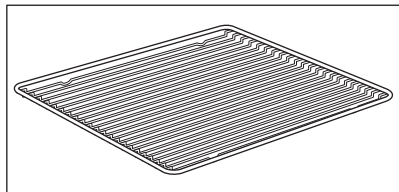

Til kogegrej, kageforme, stege.

Bageplade

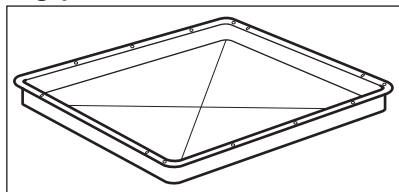

Til kager og småkager.

Grill-/bradepande

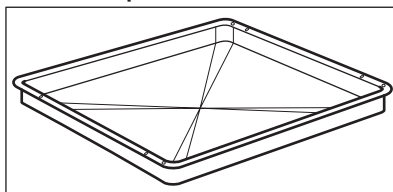

Til at bage og stege eller som en pande til opsamling af fedt.

4. BETJENINGSPANEL

4.1 Forsænkbare knapper

Tryk på funktionsvælgeren for at bruge apparatet. Funktionsvælgeren kommer ud.

4.2 Sensorfelter/knapper

—	Indstilling af tiden.
	Indstilling af en urfunktion.
+	Indstilling af tiden.

4.3 Display

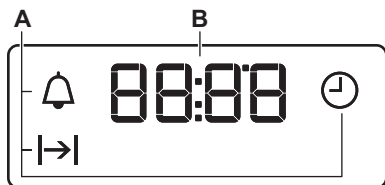

- A. Urfunktioner
- B. Timer

5. FØR FØRSTE ANVENDELSE

ADVARSEL!

Se kapitlerne om sikkerhed.

5.1 Før brug første gang

Ovnen kan udsende lugt og røg under forvarmning. Kontroller, at rummet er udluftet.



Trin 1



Trin 2



Trin 3



Indstil uret

1. **+**, **—** - tryk for at indstille tiden. Efter ca. 5 sek. holder displayet op med at blinke og viser klokkeslættet.

Rengør ovnen

1. Fjern al tilbehøret fra ovnen og tag de udtagelige ovnribber ud af ovnen.
2. Ovnen og tilbehøret rengøres kun med en mikrofiberklud, varmt vand og et mildt rengøringsmiddel.

Forvarm den tomme ovn

1. Indstil den maksimale temperatur for funktionen: .
Tid: 1 t.
2. Indstil den maksimale temperatur for funktionen: .
Tid 15 min.

Sluk for ovnen, og vent, til den er kold. Placér tilbehøret og de aftagelige ribber i ovnen.

6. DAGLIG BRUG





ADVARSEL!



Se kapitlerne om sikkerhed.

6.1 Indstilling: Ovnfunktion

Trin 1	Drej ovnens funktionsvælger for at vælge en ovnfunktion .
Trin 2	Drej funktionsvælgeren for at vælge temperaturen.
Trin 3	Når tilberedningen ender, skal du dreje knapperne til slukket position for at slukke for ovnen.

6.2 Ovnfunktioner

Ovnfunktion	Applikation
0 Sluk-position	Ovnen er slukket.
 Lys	Til at tænde lampen.
 Varmluft	Bagning på op til tre ovnriller samtidig og til tørring af fødevarer. Indstil temperaturen 20 - 40 °C lavere end ved Over-/undervarme.
 Pizza-funktionen	Til at bage pizza. Til at lave en kraftig brun og en sprød bund.
 Over-/undervarme	Til bagning og stegning af mad på én ovnrille.
 Undervarme	Til bagning af kager med sprød bund og til henkogning.
 Optøning	Til optøning af mad (grøntsager og frugt). Optøningstiden afhænger af mængde og omfang af de defrosne madvarer.

Ovnfunktion	Applikation
 Fugtig varmluft	Denne funktion er beregnet til at spare energi under madlavning. Når du bruger denne funktion, kan temperaturen i ovnrummet variere fra den indstillede temperatur. Restvarmen anvendes. Varmeeffekten kan blive reduceret. Få flere oplysninger i kapitlet "Daglig brug", Bemærkninger til: Fugtig varmluft.
 Grillstegning	Til grillstegning af tynde stykker mad og til ristning af brød.
 Turbogrill	Til stegning af større stykker kød eller fjerkræ med ben på én hyldeposition. For at lave gratiner og til at brune.

i
Lampen vil muligvis slukke automatisk ved en temperatur på under 60°C ved visse ovnfunktioner.

6.3 Bemærkninger om:Fugtig varmluft



Denne funktion blev anvendt til at overholde kravene i energiforbrugsklassen og økodesign (i overensstemmelse med EU 65/2014 og EU 66/2014). Tests i overensstemmelse med: IEC/EN 60350-1.

Ovnlågen skal være lukket under tilberedningen, så funktionen ikke afbrydes, og ovnen kører med den højeste energieffektivitet, der er mulig.

Se kapitlet "Råd" for at få vejledning om tilberedning, Fugtig varmluft. Se kapitlet "Energiforbrug" for generelle anbefalinger til Energibesparelse, energibesparelse.

7. URFUNKTIONER

7.1 Urfunktioner

Urfunktionstast	Applikation
 Aktuel tid	Bruges til at indstille, ændre eller kontrollere det aktuelle klokkeslæt.
 Varighed	Til indstilling af, hvor længe ovnen skal være tændt.
 Minutur	Bruges til at indstille en nedtælling. Denne funktion har ikke indflydelse på ovnen. Denne funktion kan indstilles på et vilkårligt tidspunkt, og også hvis ovnen er slukket.

7.2 Sådan indstilles: Urfunktioner

Sådan indstilles: Aktuel tid

 - blinker, når ovnen sluttes til strømmen, hvis der var strømafbrydelse, eller hvis timeren ikke er indstillet.

 - tryk for at indstille tiden.

Efter ca. 5 sek. holder displayet op med at blinke og viser klokkeslættet.

Sådan ændrer du Aktuel tid



Trin 1  - tryk gentagne gange for at se eller ændre den aktuelle tid.  - begynder at blinke.

Trin 2  - tryk for at indstille tiden.

Efter ca. 5 sek. holder displayet op med at blinke og viser klokkeslættet.

Sådan indstilles: Varighed

Trin 1 Indstil ovnfunktion og temperatur.

Trin 2  - tryk gentagne gange.  - begynder at blinke.

Trin 3  - tryk for at indstille varigheden.



Displayet viser: .

 - blinker, når den indstillede tid er slut. Signalet lyder, og ovnen slukkes.

Trin 4 Tryk på en vilkårlig knap for at slå lydsignalet fra.

Trin 5 Drej knapperne til sluk-positionen.

Sådan indstilles: Minutur

Trin 1  - tryk gentagne gange.  - begynder at blinke.

Sådan indstilles: Minutur

Trin 2  - tryk for at indstille tiden.
Funktionen begynder automatisk efter 5 sekunder.
Signalet lyder, når den indstillede tid er gået, .

Trin 3 Tryk på en vilkårlig knap for at slå lydsignalet fra.

Trin 4 Drej knapperne til sluk-positionen.

Sådan annullerer du Urfunktioner

Trin 1  - tryk gentagne gange, indtil symbolet for urfunktionen begynder at blinke.

Trin 2 Tryk på og hold: .
Urfunktionen slukkes efter nogle få sekunder.

8. BRUG AF TILBEHØRET

ADVARSEL!

Se kapitlerne om sikkerhed.

8.1 Isætning af tilbehør

En lille fordybning i toppen øger sikkerheden.
Fordybningerne er også antivippe-

anordninger. Den høje kant rundt om hylden
forhindrer kogegrej i at glide af hylden.

Grillrist:

Skub risten mellem ovnribbens skinner, .

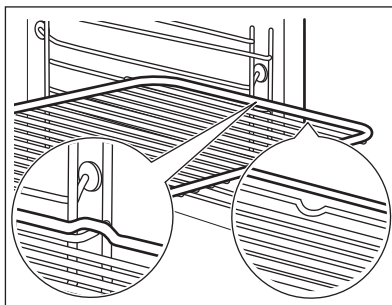

Bageplade / Dyb bradepande:

Skub den dybe bradepande ind mellem ovnríb-
bens skinner.

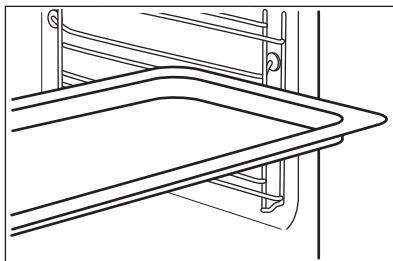

9. EKSTRAFUNKTIONER

9.1 Køleblæser

Når ovnen er tændt, tændes køleblæseren
automatisk for at holde ovnens overflader

kølige. Hvis du slukker for ovnen, kan
køleblæseren fortsætte med at køre, indtil
ovnen køler ned.

10. RÅD OG TIPS



Se kapitlerne om sikkerhed.

10.1 Anbefalinger til tilberedning



Tabellernes temperaturer og tilberedningstider er kun vejledende. De afhænger af opskrifterne og kvaliteten og mængden af de anvendte ingredienser.

Din ovn bager eller steger muligvis anderledes end den ovn, du havde før. Rådene herunder viser anbefalede indstillinger for temperatur, tilberedningstid og hyldeposition for specifikke typer mad.

Hvis du ikke kan finde indstillinger til en speciel opskrift, kan du se efter en lignende.

10.2 Bagning

Brug den lavere temperatur ved første
bagning.

Bagetiden kan forlænges med 10 – 15
minutter, når du bager på mere end én ribbe.

Kager og bagværk med forskellig højde kan
brune ujævnt. Der er ikke nødvendigt at

ændre temperaturindstillingen, hvis der sker
en ujævn bruning. Forskellene udglignes under
bagning.





Plader i ovnen kan blive forvredet under
bagning. Pladerne retter sig ud, når de er
kølet af.

10.3 Bagetip

Bageresultater	Mulige årsager	Løsning
Kagens bund er ikke bagt nok.	Forkert ovnrille.	Sæt kagen i en lavere ovnrille.

Bageresultater	Mulige årsager	Løsning
Kagen falder sammen og bliver klæg eller med vandstriber.	Der er for høj ovntemperatur.	Vælg en lidt lavere ovntemperatur den næste gang.
	Ovntemperaturen er for høj, og bagetiden er for kort.	Vælg en længere bagetid og en lavere ovntemperatur den næste gang.
Kagen er for tør.	Der er for lav ovntemperatur.	Vælg en højere ovntemperatur den næste gang.
	Bagetiden er for lang.	Vælg en kortere bagetid den næste gang.
Kagen bliver ujævnt bagt.	Ovntemperaturen er for høj, og bagetiden er for kort.	Vælg en længere bagetid og en lavere ovntemperatur den næste gang.
	Kagedejen er ikke jævnt fordelt.	Fordel kagedejen jævnt på bagepladen den næste gang.
Kagen er ikke klar på bagetiden angivet i en opskrift.	Der er for lav ovntemperatur.	Vælg en lidt højere ovntemperatur den næste gang.



10.4 Bagning på én ribbe

 BAGVÆRK I FORM		 (°C)	 (min.)	
Tærtebund - mørdej, forvarm den tomme ovn	Varmluft	170 - 180	10 - 25	2
Tærtebund - rørt kagedej	Varmluft	150 - 170	20 - 25	2
Gærkrans / Brioché	Varmluft	150 - 160	50 - 70	1
Sandkage / Frugt-kager	Varmluft	140 - 160	70 - 90	1
Cheesecake	Over-/undervarme	170 - 190	60 - 90	1

Brug ovnens tredje ristposition.

Brug funktionen: Varmluft.





Brug en bradepande.

 KAGER/BAGVÆRK/BRØD	 (°C)	 (min.)
Kage med chokoladeflager, tør	150 - 160	20 - 40
Frugttærter (på gærdej/rørt kagedej), brug en bradepande	150	35 - 55
Frugttærter på mørdej	160 - 170	40 - 80





Forvarm den tomme ovn.

Brug funktionen: Over-/undervarme.

Brug en bradepande.





 KAGER/ BAGVÆRK/BRØD	 (°C)	 (min.)	
Roulade	180 - 200	10 - 20	3
Grovbrød:	først: 230	20	1
	så: 160 - 180	30 - 60	
Smørmandelkage / Sukkerkage	190 - 210	20 - 30	3
Flødeboller / Eclairs	190 - 210	20 - 35	3
Fletbrød / Kringle	170 - 190	30 - 40	3
Frugttærter (på gærdej/ rørt kagedej), brug en bradepande	170	35 - 55	3
Gærkager med sart fyld (f.eks. kvark, fløde, creme)	160 - 180	40 - 80	3
Stollen	160 - 180	50 - 70	2

Brug ovnens tredje ristposition.

 SMÅT BAG- VÆRK		 (°C)	 (min.)
Småkager Af mørdej	Varmluft	150 - 160	10 - 20
Boller, forvarm den tomme ovn	Varmluft	160	10 - 25
Lagkagebunde af rørt dej	Varmluft	150 - 160	15 - 20
Butterdej, forvarm den tomme ovn	Varmluft	170 - 180	20 - 30
Lagkagebunde af gærdej	Varmluft	150 - 160	20 - 40
Makroner	Varmluft	100 - 120	30 - 50
Marengs / Marengs	Varmluft	80 - 100	120 - 150
Boller, forvarm den tomme ovn	Over-/undervarme	190 - 210	10 - 25

10.5 Souffleer og gratiner





Brug ovnens første ristposition.





		 (°C)	 (min.)
Flute med smeltet ost oven-på	Varmluft	160 - 170	15 - 30
Grøntsagsgratin, forvarm den tomme ovn	Turbogrill	160 - 170	15 - 30
Lasagne	Over-/undervarme	180 - 200	25 - 40
Fiskegratiner	Over-/undervarme	180 - 200	30 - 60
Fyldte grøntsager	Varmluft	160 - 170	30 - 60
Søde bagværk	Over-/undervarme	180 - 200	40 - 60
Pastagratin	Over-/undervarme	180 - 200	45 - 60

10.6 Bagning på flere ribber

Brug funktionen: Varmluft.

Brug bagepladerne.

 KAGER/ BAGVÆRK	 (°C)	 (min.)	 2 riller
Flødeboller / Eclairs, forvarm den tomme ovn	160 - 180	25 - 45	1 / 4
Tør, toscatærte	150 - 160	30 - 45	1 / 4

 SMÅT BAGVÆRK/SMÅ KAGER/BOLLER	 (°C)	 (min.)	 2 riller	 3 riller
Boller	180	20 - 30	1 / 4	-
Småkager Af mørdej	150 - 160	20 - 40	1 / 4	1 / 3 / 5
Lagkagebunde af rørt dej	160 - 170	25 - 40	1 / 4	-
Butterdej, forvarm den tomme ovn	170 - 180	30 - 50	1 / 4	-
Lagkagebunde af gærdej	160 - 170	30 - 60	1 / 4	-
Makroner	100 - 120	40 - 80	1 / 4	-
Marengs / Marengs	80 - 100	130 - 170	1 / 4	-

10.7 Tips til stegning

Brug varmeresistent ovngrej.

Steg magert kød tildækket (du kan bruge aluminiumsfolie).

Steg store stege direkte i fadet.

Hæld noget vand i bakken for at forhindre, at dryppende fedt brænder.

Vend stegen efter 1/2 - 2/3 af tilberedningstiden.













Steg kød og fisk i store stykker (1 kg eller mere).

Hvis det foreslås, at maden sættes i rille 1 sættes den direkte på bagepladen

Dryp stege med deres egen saft adskillige gange under stegning.

10.8 Stegning

Brug ovnens første ristposition.

 OKSEKØD				
			 (°C)	 (min.)
Grydesteg	1 - 1,5 kg	Over-/undervarme	230	120 - 150
Roastbeef eller filet, rød, forvarm den tomme ovn	pr. cm i højden	Turbogrill	190 - 200	5 - 6
Roastbeef eller filet, medium, forvarm den tomme ovn	pr. cm i højden	Turbogrill	180 - 190	6 - 8
Roastbeef eller filet, gennemstegt, forvarm den tomme ovn	pr. cm i højden	Turbogrill	170 - 180	8 - 10
 SVIN				
 Brug funktionen: Turbogrill.				
	 (kg)		 (°C)	 (min.)
Bov / Nakke / Skinke m. Ben	1 - 1.5		160 - 180	90 - 120
Koteletter / Spareribs	1 - 1.5		170 - 180	60 - 90
Farsbrød	0.75 - 1		160 - 170	50 - 60
Svineskank, forkogt	0.75 - 1		150 - 170	90 - 120



KALVEKØD



Brug funktionen: Turbogrill.



(kg)



(°C)



(min.)

Kalvesteg

1

160 - 180

90 - 120

Kalveskank

1.5 - 2

160 - 180

120 - 150



LAMMEKØD



Brug funktionen: Turbogrill.



(kg)



(°C)



(min.)

Lammekølle / Lammesteg

1 - 1.5

150 - 170

100 - 120

Lammeryg

1 - 1.5

160 - 180

40 - 60



VILDT



Brug funktionen: Over-/undervarme.



(kg)



(°C)



(min.)

Ryg / Harekølle, forvarm den tomme ovn

op til 1

230

30 - 40

Vildtryg

1.5 - 2

210 - 220

35 - 40

Kølle

1.5 - 2

180 - 200

60 - 90



FJERKRÆ



Brug funktionen: Turbogrill.



(kg)



(°C)



(min.)

Udskåret fjerkræ	0,2 - 0,25 hver	200 - 220	30 - 50
Fjerkræ, halveret	0,4 - 0,5 hver	190 - 210	35 - 50
Kylling, poulard	1 - 1,5	190 - 210	50 - 70
And	1,5 - 2	180 - 200	80 - 100
Gås	3,5 - 5	160 - 180	120 - 180
Kalkun	2,5 - 3,5	160 - 180	120 - 150
Kalkun	4 - 6	140 - 160	150 - 240



FISK (DAMPNING)



Brug funktionen: Over-/undervarme.



(kg)



(°C)



(min.)

Hel fisk	1 - 1,5	210 - 220	40 - 60
----------	---------	-----------	---------

10.9 Sprød tilberedning med: Pizza-funktionen



PIZZA



Brug ovnens første ristposition.



(°C)



(min.)

Tærter	180 - 200	40 - 55
Spinattærte	160 - 180	45 - 60
Quiche lorraine / Madtærte	170 - 190	45 - 55



PIZZA



Brug ovnens første ristposition.



(°C)



(min.)

Cheesecake	140 - 160	60 - 90
Grøntsagstærte	160 - 180	50 - 60



PIZZA



Forvarm den tomme ovn inden tilberedning.



Brug ovnens anden ristposition.



(°C)



(min.)

Pizza, tynd bund, brug en bradepande	200 - 230	15 - 20
--------------------------------------	-----------	---------

Pizza, tyk bund	180 - 200	20 - 30
-----------------	-----------	---------

Flade madbrød	230 - 250	10 - 20
---------------	-----------	---------

Tærte med but-terdej	160 - 180	45 - 55
----------------------	-----------	---------



PIZZA



Forvarm den tomme ovn inden tilberedning.



Brug ovnens anden ristposition.



(°C)



(min.)

Flammkuchen	230 - 250	12 - 20
-------------	-----------	---------

Pirogger	180 - 200	15 - 25
----------	-----------	---------

10.10 Grillstegning

Forvarm den tomme ovn inden tilberedning.

Grillsteg kun tynde stykker af kød eller fisk.

Anbring en plade på den første ristposition for at opsamle fedt.



GRILL



Brug funktionen: Grillstegning



(°C)

(min.)
1. side(min.)
2. side

	(°C)	(min.) 1. side	(min.) 2. side	
Engelsk roastbeef	210 - 230	30 - 40	30 - 40	2
Oksefilet	230	20 - 30	20 - 30	3
Svinekam	210 - 230	30 - 40	30 - 40	2
Kalvekam	210 - 230	30 - 40	30 - 40	2
Lammetryg	210 - 230	25 - 35	20 - 25	3
Hel fisk, 0,5 kg - 1 kg	210 - 230	15 - 30	15 - 30	3 / 4

10.11 Frosne madvarer



OPTØNING



Brug funktionen: Varmluft.



(°C)



(min.)



Pizza, frossen	200 - 220	15 - 25	2
Deep pan pizza, frossen	190 - 210	20 - 25	2
Pizza, kold	210 - 230	13 - 25	2
Pizza snacks, frosne	180 - 200	15 - 30	2
Pommes frites, tynde	200 - 220	20 - 30	3
Pommes frites, tykke	200 - 220	25 - 35	3
Kartoffelbåde / Kroketter	220 - 230	20 - 35	3
Brasede kartofler	210 - 230	20 - 30	3
Lasagne / Cannelloni, frisk	170 - 190	35 - 45	2
Lasagne / Cannelloni, frossen	160 - 180	40 - 60	2
Bagt ost	170 - 190	20 - 30	3
Kyllingevinger	190 - 210	20 - 30	2

10.12 Optøning

Tag maden ud af emballagen og læg den på en tallerken.

Tilbered ikke maden, da dette kan forlænge optøningstiden.

Brug ovnens første ristposition.

For store portioner mad anbringes en omvendt tom tallerken på bunden af ovnrummet. Læg maden i et dybt fad, og stil det oven på tallerkenen i ovnen. Tag om nødvendigt ovnribberne ud.



(kg)







(min.)
Optøningstid



(min.)
Yderligere optøningstid



Kylling	1	100 - 140	20 - 30	Vendes undervejs.
Kød	1	100 - 140	20 - 30	Vendes undervejs.
Ørred	0.15	25 - 35	10 - 15	-
Jordbær	0.3	30 - 40	10 - 20	-

	 (kg)	 (min.) Optøningstid	 (min.) Yderligere optøningstid	
Smør	0.25	30 - 40	10 - 15	-
Fløde	2 x 0,2	80 - 100	10 - 15	Pisk fløden, mens den stadig er lidt frossen nogle steder.
Kage	1.4	60	60	-

10.13 Henkogning

Brug funktionen Undervarme.

Brug kun standardhenkogningsglas i samme størrelse.

Brug ikke glas med skrue- og bajonetlåg eller metalåser.

Brug ovnens første ristposition.

Stil højst seks 1 liters henkogningsglas på bagepladen.



Fyld glassene ens og luk med en bøjle.



Glassene må ikke røre hinanden.



Hæld ca. 1/2 liter vand på bagepladen, så luften i ovnen er tilstrækkelig fugtig.

Sluk for ovnen, eller sæt temperaturen ned til 100 °C, når væsken i glassene begynder at simre (i 1 liter-glas efter ca. 35 - 60 minutter) (se tabellen).

Indstil temperaturen til 160 - 170 °C.

 BLØD FRUGT	 (min.) Henkogning til simring
Jordbær / Blåbær / Hindbær / Modne stikkelsbær	35 - 45

 STEN-FRUGT	 (min.) Henkogning til simring	 (min.) Kog færdig ved 100 °C
Ferskner / Kvæder / Blommer	35 - 45	10 - 15

 GRØNTSAGER	 (min.) Henkogning til simring	 (min.) Kog færdig ved 100 °C
Gulerødder	50 - 60	5 - 10
Agurker	50 - 60	-
Blandet pickles	50 - 60	5 - 10
Kålramb / Ærter / Asparges	50 - 60	15 - 20



10.14 Tørring - Varmluft

Dæk bakkerne med fedttæt papir eller bagepapir.



For at opnå et bedre resultat skal du stoppe ovnen halvvejs gennem tørretiden, åbne døren og lade den køle af én nat for at afslutte tørringen.

Brug den tredje rille til 1 plade.

Brug den første og fjerde rille til 2 plader.



 GRØNTSA- GER	 (°C)	 (t)
Bønner	60 - 70	6 - 8
Peberfrugt	60 - 70	5 - 6
Suppegrøntsager	60 - 70	5 - 6
Champignons	50 - 60	6 - 8
Krydderurter	40 - 50	2 - 3

Indstil temperaturen til 60 - 70 °C.

 FRUGT	 (t)
Blommer	8 - 10
Abrikoser	8 - 10
Æble i skiver	6 - 8
Pærer	6 - 9



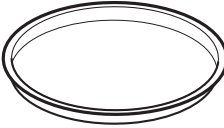
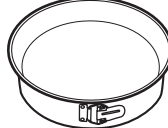

10.15 Fugtig varmluft - anbefalet tilbehør

Brug mørke og ikke-reflekterende former og beholdere. De har en bedre varmeabsorbering end lyse og reflekterende fade.

			
Pizzaform	Bageform	Ramekiner	Tærtbundform
Mørk, ikke-reflekterende 28 cm diameter	Mørk, ikke-reflekterende 26 cm diameter	Keramisk 8 cm diameter, 5 cm højde	Mørk, ikke-reflekterende 28 cm diameter

10.16 Fugtig varmluft





For at få de bedste resultater skal du følge forslagene angivet på nedenstående tabel.

	 (°C)	 (min.)	
Brødstænger, 0,5 kg i alt	190 - 200	50 - 60	3
Bagte kammuslinger i skal	180 - 200	30 - 40	4
Hel fisk i salt, 0,3 - 0,5 kg	190 - 200	45 - 50	4
Hel fisk i pergament, 0,3 - 0,5 kg	190 - 200	50 - 60	3
Amaretti (20; 0,5 kg i alt)	170 - 180	40 - 50	3
Æble-smuldrekege	190 - 200	50 - 60	4
Chokolademuffins (20; 0,5 kg i alt)	160 - 170	35 - 45	3





10.17 Information til testinstitutter

Tests i overensstemmelse med: EN 60350, IEC 60350.





Bagning i ét lag - bagning i forme

		 °C	 min	
Fedtfattig sandkage	Varmluft	160	45 - 60	2
Fedtfattig sandkage	Over-/undervarme	160	45 - 60	2
Æbletærte, 2 forme Ø20 cm	Varmluft	160	55 - 65	2
Æbletærte, 2 forme Ø20 cm	Over-/undervarme	180	55 - 65	1
Smørkager	Varmluft	140	25 - 35	2
Smørkager	Over-/undervarme	140	25 - 35	2

Bagning i ét lag - lagkagebunde Brug den tredje ovnrille.

		 °C	 min
Små kager i form, 20 stk./plade, forvarm den tomme ovn	Varmluft	150	20 - 30
Små kager i form, 20 stk./plade, forvarm den tomme ovn	Over-/undervarme	170	20 - 30





Bagning i flere lag - lagkagebunde

		 °C	 min	
Smørkager	Varmluft	140	25 - 45	2 / 4
Små kager i form, 20 stk./ plade, forvarm den tomme ovn	Varmluft	150	25 - 35	1 / 4
Fedtfattig sandkage	Varmluft	160	45 - 55	2 / 4
Æbletærte, 1 form pr. rist (Ø 20 cm)	Varmluft	160	55 - 65	2 / 4

Grillstegning

Forvarm den tomme ovn i 5 minutter.

Grill med den maksimale temperaturindstilling.

		 min	
Toast	Grillstegning	1 - 2	5
Oksesteak, vendes undervejs	Grillstegning	24 - 30	4

11. VEDLIGEHOLDELSE OG RENGØRING

ADVARSEL!

Se kapitlerne om sikkerhed.

11.1 Bemærkninger om rengøring



Rengøringsmidler

Rengør ovnens front med en mikrofiberklud med varmt vand og et mildt rengøringsmiddel.

Brug en rengøringsmiddelopløsning til at rengøre metaloverflader.

Rengør pletter med et mildt rengøringsmiddel.



Hverdagsbrug

Rengør altid ovnrummet efter brug. Ophobning af fedt eller andre rester kan forårsage brand.

Opbevar ikke madvarer i ovnen i mere end 20 minutter. Ovnrummet tørres kun med en mikrofiberklud efter hver brug.



Tilbehør

Rengør alt tilbehør efter hver brug, og lad det tørre. Brug en mikrofiberklud med varmt vand og et mildt rengøringsmiddel. Tilbehøret må ikke vaskes i opvaskemaskinen.

Rengør ikke non stick-tilbehøret med slibende rengøringsmiddel eller genstande med skarpe kanter.

11.2 Fjernelse: Ovnribber

Fjern ovnribberne, så ovnen kan rengøres.

Trin 1 Sluk for ovnen, og vent, til den er kold.

Trin 2 Træk forenden af ribben væk fra sidevæggen.

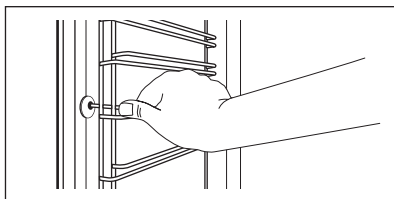

Trin 3 Træk den bageste ende af ovnribben væk fra sidevæggen, og tag den ud.

Trin 4 Montér ovnribberne i modsat rækkefølge.

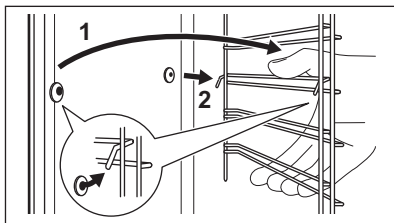

11.3 Fjernelse: Grill

⚠ ADVARSEL!

Der er risiko for forbrænding.

Trin 1 Sluk for ovnen, og vent, til den er kold for at rengøre den. Tag ovnribberne ud.

Trin 2 Tag fat i grillhjørnerne. Træk den fremad mod fjedertrykket og ud af de to holdere. Grillen foldes ned.

Trin 3 Rengør ovnloftet med lunkent vand, en blød klud og et mildt rengøringsmiddel. Lad det tørre.

Trin 4 Montér grillen i omvendt rækkefølge.

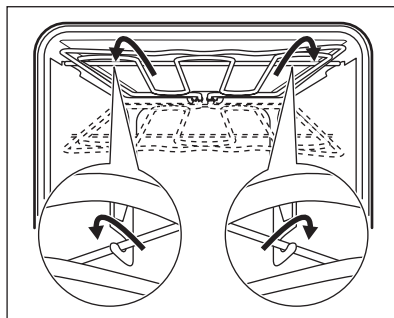

Trin 5 Montér ovnribberne.

11.4 Sådan fjerner og installerer du: Låge

Du kan tage lågen og det indvendige ovnglas ud for at rengøre det. Antallet af glaspaneler er forskelligt for forskellige modeller.

⚠ ADVARSEL!

Døren er tung.

⚠ FORSIGTIG!

Håndter forsigtigt glasset, især omkring frontpanelets kanter. Glasset kan gå i stykker.

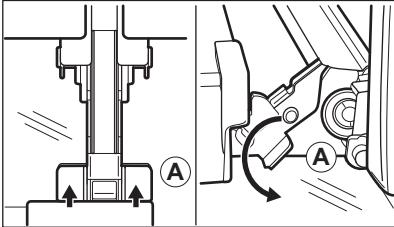
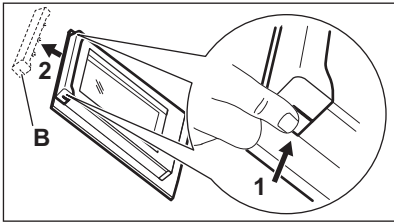
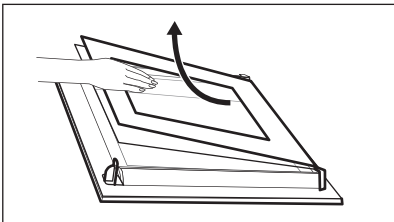
Trin 1	Åbn lågen helt.	
Trin 2	Løft og tryk låsegrebene (A) helt på de to lågehængsler.	
Trin 3	Sæt ovnlågen i den første tætte position (vinkel på ca. 70°). Hold lågen i begge sider, og træk den væk fra ovnen i en vinkel opad. Læg lågen med ydersiden nedad på en blød klud på et stabilt underlag.	
Trin 4	Hold i begge sider af lågelisten (B) i lågens overkant, og tryk indad, indtil låsehagen slipper.	
Trin 5	Træk lågelisten fremad, og tag den ud.	
Trin 6	Hold i overkanten af hvert enkelt ovnglas, og træk det opad og ud af skinnen.	
Trin 7	Rengør glaspanelet med vand og sæbe. Tør ovnglasset forsigtigt. Ovnglasset må ikke komme i opvaske maskinen.	
Trin 8	Udfør ovennævnte trin i omvendt rækkefølge efter rengøring.	
Trin 9	Sæt det mindste glas i først og derefter det største og lågen. Sørg for, at glassene er sat i den rigtige position, da lågens overflade ellers kan blive overophedet.	

11.5 Udskiftning: Lampe

ADVARSEL!

Risiko for elektrisk stød
Pæren kan være varm.

Før du udskifter pæren:

Trin 1	Trin 2	Trin 3
Sluk for ovnen. Vent, til ovnen er kold.	Tag stikket ud af kontakten.	Læg en klud i bunden af ovnrummet.

Toplampe

Trin 1 Drej glasset, og tag det af.

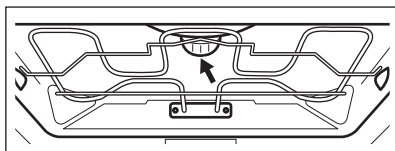

Trin 2 Rengør glasdækslet.

Trin 3 Udskift pæren med en passende 300 °C varrefast pære.

Trin 4 Montér glasdækslet.

12. FEJLFINDING

⚠ ADVARSEL!

Se kapitlerne om sikkerhed.

12.1 Hvad gør du, hvis ...

I eventuelle tilfælde, der ikke er inkluderet i denne tabel, bedes du kontakte et autoriseret servicecenter.

Problem	Kontrollér, om ...
Ovnen opvarmes ikke.	Sikringen er sprunget.
Displayet viser "12.00".	Der har været strømafbrydelse. Indstil aktuel tid.
Pæren virker ikke.	Pæren er sprunget.

12.2 Servicedata

Kontakt din forhandler eller et autoriseret servicecenter, hvis du ikke selv kan løse problemet.

De nødvendige oplysninger til servicecenteret er angivet på maskinens typeskilt. Typeskiltet sidder på ovnens frontramme. Typeskiltet må ikke fjernes fra ovnrummet.

Det anbefales, at du noterer oplysningerne her:

Model (MOD.)

Produktnummer (PNC)

Serienummer (S.N.)

13. ENERGIEFFEKTIV

13.1 Produktoplysninger og ark med produktoplysninger i henhold til EU's forordninger om økodesign og energimærkning

Leverandørens navn	AEG
Identifikation af model	BEK435060B 944188455 EB40B 944188534
Energieffektivitetsindeks	81.2

Energieffektivitetsklasse	A+	
Energiforbrug med en standardmængde, almindelig tilstand	0.99kWh/cyklus	
Energiforbrug med en standardmængde, blæsertungen tilstand	0.69kWh/cyklus	
Antal ovnrum	1	
Varmekilde	Elektricitet	
Lydstyrke	71l	
Type ovn	Indbygningsovn	
Vægt	BEK435060B	33.0kg
	EB40B	33.0kg

IEC/EN 60350-1 - Elektriske husholdningsapparater til madlavning - Del 1: Komfurer, ovne, dampovne og grillapparater - Metoder til måling af ydeevne.

13.2 Energibesparelse



Apparatet indeholder funktioner, som hjælper dig med at spare energi ved daglig madlavning.

Sørg for, at ovnens låge er lukket, når ovnen er tændt. Åbn ikke ovnlågen for ofte under tilberedningen. Hold dørpakningen ren og sørg for, at den sidder godt fast.

Brug køkkengrej af metal for at øge energibesparelsen.

Forvarm om muligt ikke ovnen inden tilberedning.

Hold pauserne mellem bagning så korte som muligt, når du tilbereder nogle få retter på én gang.

Tilberedning med blæser

Brug om muligt tilberedningsfunktionerne med blæser for at spare energi.

Restvarme

Når tilberedningsvarigheden er længere end 30 min., skal du reducere ovntemperaturen til minimum 3 - 10 min. inden tilberedningen er slut. Eftervarmen i ovnen vil blive ved med at tilberede maden.

Brug restvarmen til at opvarme andre retter.

Hold maden varm

Vælg den lavest mulige temperaturindstilling for at bruge restvarme og holde et måltid varmt.

Fugtig varmluft

Denne funktion er beregnet til at spare energi under madlavning.

14. MILJØHENSYN

Genbrug materialer med symbolet . Anbring emballagematerialet i passende beholdere til genbrug. Hjælp med at beskytte miljøet og menneskelig sundhed samt at genbruge affald af elektriske og elektroniske apparater. Kasser ikke apparater, der er

mærket med symbolet , sammen med husholdningsaffaldet. Lever produktet tilbage til din lokale genbrugsplads eller kontakt din kommune.

VOOR PERFECTE RESULTATEN

Bedankt dat je voor dit AEG-product hebt gekozen. We hebben het gecreëerd om jarenlang onberispelijke prestaties te leveren, met innovatieve technologieën die het leven eenvoudiger maken – functies die je wellicht niet op gewone apparaten aantreft. Neem een paar minuten de tijd om het beste uit het apparaat te halen.

Ga naar onze website voor:



Advies over gebruik, brochures, het oplossen van problemen, service- en reparatie-informatie:

www.aeg.com/support



Registreer je product voor een betere service:

www.registeraeg.com



Koop accessoires, verbruiksartikelen en originele reserveonderdelen voor je apparaat:

www.aeg.com/shop

KLANTENSERVICE EN SERVICE

Gebruik altijd originele onderdelen.

Als u contact opneemt met onze erkende servicedienst, zorg er dan voor dat u de volgende gegevens tot uw beschikking hebt: Model, PNC, serienummer.

De informatie vindt u op het typeplaatje.

 Waarschuwingen en veiligheidsinformatie

 Algemene informatie en tips

 Milieu-informatie

Wijzigingen voorbehouden.

INHOUDSOPGAVE

1. VEILIGHEIDSINFORMATIE.....	30
2. VEILIGHEIDSVOORSCHRIFTEN.....	32
3. BESCHRIJVING VAN HET PRODUCT.....	34
4. BEDIENINGSPANEEL.....	35
5. VOOR HET EERSTE GEBRUIK.....	36
6. DAGELIJKS GEBRUIK.....	36
7. KLOKFUNCTIES.....	37
8. GEBRUIK VAN DE ACCESSOIRES.....	39
9. EXTRA FUNCTIES.....	39
10. AANWIJZINGEN EN TIPS.....	39
11. ONDERHOUD EN REINIGING.....	52
12. PROBLEEMOPLOSSING.....	55
13. ENERGIEZUINIGHEID.....	56
14. MILIEUBESCHERMING.....	57

1. ⚠️ VEILIGHEIDSINFORMATIE

Lees zorgvuldig de meegeleverde instructies voor installatie en gebruik van het apparaat. De fabrikant is niet verantwoordelijk voor verwondingen of schade die voortvloeit uit de onjuiste installatie of het onjuiste gebruik. Bewaar de instructies altijd op een veilige, toegankelijke plek voor toekomstig gebruik.

1.1 De veiligheid van kinderen en kwetsbare personen

- Dit apparaat kan worden gebruikt door kinderen van 8 jaar en ouder en door mensen met een beperkt lichamelijk, zintuiglijk of verstandelijk vermogen of een gebrek aan ervaring en kennis, indien zij onder toezicht staan of instructies hebben gekregen over het veilig gebruiken van het apparaat en indien zij de gevaren begrijpen. Kinderen jonger dan 8 jaar en personen met zware en complexe beperkingen dienen altijd uit de buurt van het apparaat te worden gehouden, tenzij ze voortdurend onder toezicht staan.
- Houd toezicht op kinderen om te voorkomen dat zij met het apparaat gaan spelen..
- Houd alle verpakking uit de buurt van kinderen en gooi het op passende wijze weg.
- **WAARSCHUWING:** Het apparaat en de toegankelijke onderdelen ervan worden heet tijdens het gebruik. Houd kinderen en huisdieren uit de buurt van het apparaat tijdens het gebruik en bij het afkoelen.
- Als het apparaat is voorzien van een kinderslot, dient dit te worden geactiveerd.
- Kinderen mogen zonder toezicht geen reinigings- en onderhoudswerkzaamheden aan het apparaat uitvoeren.

1.2 Algemene veiligheid

- Dit apparaat is uitsluitend bestemd om mee te koken.

- Dit apparaat is bedoeld voor binnenshuis huishoudelijk gebruik.
- Dit apparaat kan worden gebruikt in kantoren, hotelkamers, bed & breakfast-kamers, boerderijgasthuizen en andere soortgelijke accommodaties waar dergelijk gebruik de (gemiddelde) huishoudelijke gebruiksniveaus niet overschrijdt.
- Alleen een erkende installatietechnicus mag dit apparaat installeren en de kabel vervangen.
- Gebruik het apparaat niet voordat u het in de ingebouwde constructie installeert.
- Trek de stekker van het apparaat uit het stopcontact voordat u welke soort onderhoud dan ook gaat uitvoeren.
- Als het netsnoer beschadigd is, moet de fabrikant, een erkend servicecentrum of een gekwalificeerde persoon deze vervangen teneinde gevaarlijke situaties met elektriciteit te voorkomen.
- **WAARSCHUWING:** Zorg ervoor dat het apparaat is uitgeschakeld voordat u de lamp vervangt om elektrische schokken te voorkomen.
- **WAARSCHUWING:** Het apparaat en de toegankelijke onderdelen ervan worden heet tijdens het gebruik. Zorg ervoor dat je de verwarmingselementen of het oppervlak van de apparaatruimte niet aanraakt.
- Gebruik altijd ovenhandschoenen om accessoires of ovenschalen te verwijderen of erin te plaatsen.
- Om de inschuifrailen te verwijderen trek eerst de voorkant van de inschuifrail en dan de achterkant uit de zijwanden. Plaats de inschuifrails in omgekeerde volgorde.
- Gebruik geen stoomreiniger om het apparaat schoon te maken.
- Gebruik nooit agressieve reinigingsmiddelen of scherpe metalen schrapers om de glazen deur schoon te maken. Deze kunnen krassen veroorzaken op het oppervlak, waardoor het glas zou kunnen breken.

2. VEILIGHEIDSVOORSCHRIFTEN

2.1 Installeren



WAARSCHUWING!

Alleen een erkende installatietechnicus mag het apparaat installeren.

- Verwijder alle verpakkingsmaterialen.
- Installeer en gebruik geen beschadigd apparaat.
- Volg de installatie-instructies die zijn meegeleverd met het apparaat.
- Pas altijd op bij verplaatsing van het apparaat, want het is zwaar. Gebruik altijd veiligheidshandschoenen en gesloten schoeisel.
- Trek het apparaat nooit aan de handgreep van zijn plaats.
- Installeer het apparaat op een veilige en geschikte plaats die aan alle installatie-eisen voldoet.
- Houd de minimumafstand naar andere apparaten en units in acht.
- Controleer, voordat je het apparaat monteert, of de ovendeur onbelemmerd open is.
- Het apparaat is uitgerust met een elektrisch koelsysteem. Het moet worden gebruikt met de elektrische voeding.
- De inbouweenheid moet voldoen aan de stabiliteitsvereisten van DIN 68930.

Minimumhoogte kast (Minimumhoogte kast onder werkblad)	578 (600) mm
Kastbreedte	560 mm
Kastdiepte	550 (550) mm
Hoogte van de voorkant van het apparaat	594 mm
Hoogte van de achterkant van het apparaat	576 mm
Breedte van de voorkant van het apparaat	595 mm
Breedte van de achterkant van het apparaat	559 mm
Diepte van het apparaat	567 mm
Ingebouwde diepte van het apparaat	546 mm

Diepte met open deur	1027 mm
Minimumgrootte ventilatieopening. Opening geplaatst aan de onderkant van de achterzijde	560x20 mm
Lengte netvoedingskabel. Kabel wordt in de rechterhoek van de achterzijde geplaatst	1500 mm
Bevestigingsschroeven	4x25 mm

2.2 Elektrische aansluiting



WAARSCHUWING!

Gevaar voor brand en elektrische schokken.

- Alle elektrische aansluitingen moeten door een gediplomeerd elektromonteur worden gemaakt.
- Dit apparaat moet worden aangesloten op een geaard stopcontact.
- Zorg ervoor dat de parameters op het vermogensplaatje overeenkomen met elektrische vermogen van de netstroom.
- Gebruik altijd een juist geïnstalleerd schokbestendig stopcontact.
- Gebruik geen adapters met meerdere stekkers en verlengkabels.
- Zorg dat u de netstekker en het netsnoer niet beschadigt. Indien de voedingskabel moet worden vervangen, dan moet dit gebeuren door onze Klantenservice.
- Laat de stroomkabel niet in aanraking komen met de deur van het apparaat of de niche onder het apparaat, met name niet als deze werkt of als de deur heet is.
- De schokbescherming van delen onder stroom en geïsoleerde delen moet op zo'n manier worden bevestigd dat het niet zonder gereedschap kan worden verplaatst.
- Steek de stekker pas in het stopcontact als de installatie is voltooid. Zorg ervoor dat het netsnoer na installatie bereikbaar is.
- Als het stopcontact los zit, mag u de stekker niet in het stopcontact steken.

- Trek niet aan het netsnoer om het apparaat los te koppelen. Trek altijd aan de stekker.
- Gebruik enkel correcte isolatievoorzieningen: stroomonderbrekers, zekeringen (schroefzekeringen moeten uit de houder worden verwijderd), aardlekschakelaars en contactgevers.
- De elektrische installatie moet een isolatieapparaat bevatten waardoor het apparaat volledig van het lichtnet afgesloten kan worden. Het isolatieapparaat moet een contactopening hebben met een minimale breedte van 3 mm.
- Dit apparaat wordt geleverd met een stekker en een netsnoer.

2.3 Gebruik



WAARSCHUWING!

Gevaar voor letsel, brandwonden, elektrische schokken of een explosie.

- De specificatie van dit apparaat niet wijzigen.
- Zorg ervoor dat de ventilatieopeningen niet geblokkeerd worden.
- Laat het apparaat tijdens de werking niet onbeheerd achter.
- Schakel het apparaat na elk gebruik uit.
- Wees voorzichtig met het openen van de deur van het apparaat wanneer het apparaat in werking is. Er kan hete lucht vrijkomen.
- Gebruik het apparaat niet met natte handen of als het contact maakt met water.
- Oefen geen druk uit op de open deur.
- Gebruik het apparaat niet als werkblad of als opslagoppervlak.
- Open de deur van het apparaat voorzichtig. Het gebruik van ingrediënten met alcohol kan een mengsel van alcohol en lucht veroorzaken.
- Laat geen vonken of open vlammen in contact met het apparaat komen wanneer u de deur opent.
- Plaats geen ontvlambare producten of artikelen die vochtig zijn met ontvlambare producten in, bij of op het apparaat.



WAARSCHUWING!

Risico op schade aan het apparaat.

- Om schade of verkleuring van het email te voorkomen:
 - plaats ovenschalen of andere voorwerpen niet rechtstreeks op de bodem van het apparaat.
 - leg geen aluminiumfolie op de bodem van de ruimte in het apparaat.
 - plaats geen water direct in het hete apparaat.
 - bewaar geen vochtige gerechten en voedsel in het apparaat nadat u klaar bent met koken.
 - wees voorzichtig bij het verwijderen of bevestigen van accessoires.
- Verkleuring van het email of roestvrij staal is niet van invloed op de werking van het apparaat.
- Gebruik een diepe pan voor vochtige taarten. Vruchtensappen veroorzaken vlekken die permanent kunnen zijn.
- Kook altijd met de deur van het apparaat gesloten.
- Als het apparaat achter een meubelpaneel gemonteerd is (bijv. een deur), zorg er dan voor dat de deur nooit gesloten is als het apparaat in werking is. Warmte en vocht kunnen achter een gesloten meubelpaneel ophopen en schade aan het apparaat, de behuizing of de vloer veroorzaken. Sluit het meubelpaneel niet tot het apparaat compleet is afgekoeld na gebruik.

2.4 Onderhoud en reiniging



WAARSCHUWING!

Gevaar voor letsel, brand en schade aan het apparaat.

- Schakel het apparaat uit en trek de stekker uit het stopcontact voordat u onderhoudshandelingen verricht.
- Zorg ervoor dat het apparaat is afgekoeld. Er bestaat een risico dat de glasplaten kunnen breken.
- Vervang direct de glazen deurpanelen als deze beschadigd zijn. Neem contact op met een erkend servicecentrum.
- Wees voorzichtig als u de deur van het apparaat verwijdert. De deur is zwaar!

- Reinig het apparaat regelmatig om te voorkomen dat het materiaal van het oppervlak achteruitgaat.
- Maak het apparaat schoon met een vochtige zachte doek. Gebruik alleen neutrale schoonmaakmiddelen. Gebruik geen schuurmiddelen, schuursponsjes, oplosmiddelen of metalen voorwerpen.
- Volg als u een ovenspray gebruikt de aanwijzingen op de verpakking.

2.5 Binnenverlichting



WAARSCHUWING!

Gevaar voor elektrische schokken.

- Met betrekking tot de lamp(en) in dit product en reservelampen die afzonderlijk worden verkocht: Deze lampen zijn bedoeld om bestand te zijn tegen extreme fysieke omstandigheden in huishoudelijke apparaten, zoals temperatuur, trillingen, vochtigheid, of zijn bedoeld om informatie te geven over de operationele status van het apparaat. Ze zijn niet bedoeld voor gebruik in andere toepassingen en zijn niet geschikt voor verlichting in huishoudelijke ruimten.

- Dit product bevat een lichtbron van energie-efficiëntieklasse G.
- Gebruik alleen lampjes met dezelfde specificaties.

2.6 Service

- Neem contact op met de erkende servicedienst voor reparatie van het apparaat.
- Gebruik alleen originele reserveonderdelen.

2.7 Verwijdering



WAARSCHUWING!

Gevaar voor letsel of verstikking.

- Neem contact op met uw plaatselijke overheid voor informatie over het afvoeren van het apparaat.
- Haal de stekker uit het stopcontact.
- Snijd het netsnoer vlak bij het apparaat af en gooi het weg.
- Verwijder de deurvergrendeling om te voorkomen dat kinderen of huisdieren binnen in het apparaat vast komen te zitten.

3. BESCHRIJVING VAN HET PRODUCT

3.1 Algemeen overzicht

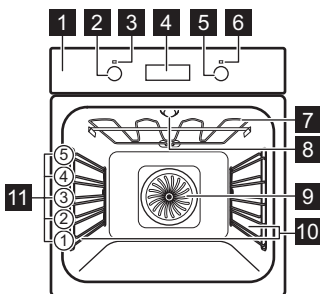

- 1 Bedieningspaneel
- 2 Knop voor verwarmingsfuncties
- 3 Aan-uitlampje/symbool
- 4 Display
- 5 Bedieningsknop (voor de temperatuur)
- 6 Temperatuurindicator/symbool
- 7 Verwarmingselement
- 8 Lamp
- 9 Ventilator
- 10 Inschuifrails, verwijderbaar
- 11 Inzetniveaus

3.2 Accessoires

Bakrooster

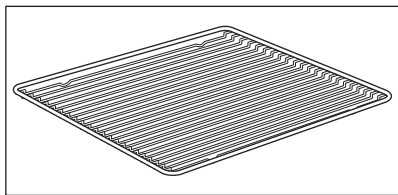

Voor kookgerei, bak- en braadvormen.

Bakplaat

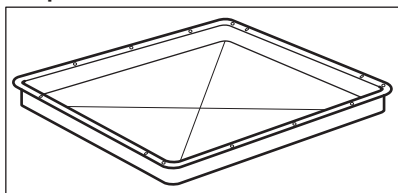

Voor gebak en koekjes.

Grill-/braadpan

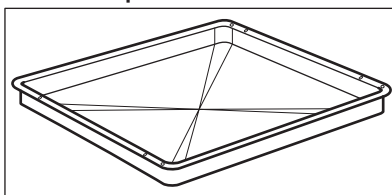

Om te bakken en braden of als een pan om vet in op te vangen.

4. BEDIENINGSPANEEL

4.1 Verzonken knoppen

Om het apparaat te bedienen, moet u de bedieningsknop indrukken. De knop komt dan naar buiten.

4.2 Sensorveld / Knoppen

—	De tijd instellen.
⌚	De klokfunctie instellen.
+	De tijd instellen.

4.3 Display

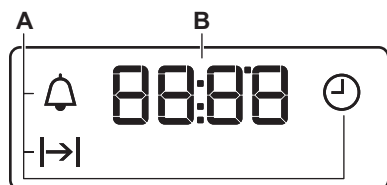

- A. Klokfuncties
- B. Timer

5. VOOR HET EERSTE GEBRUIK

WAARSCHUWING!

Raadpleeg de hoofdstukken Veiligheid.

5.1 Voorafgaand aan het eerste gebruik

De oven kan een vreemde geur en rook afgeven tijdens het voorverwarmen. Zorg ervoor dat de kamer goed is geventileerd.





Stap 1



Stap 2



Stap 3

Stel de klok in	De oven reinigen	Verwarm de lege oven voor
1.  - druk hierop om de tijd in te stellen. Na ongeveer 5 seconden stopt het knipperen en geeft de klok de tijd weer.	1. Haal alle accessoires en verwijderbare inschuifrails uit de oven. 2. Reinig de oven en de accessoires alleen met een microvezeldoek, warm water en een mild reinigingsmiddel.	1. Stel de maximale temperatuur in voor de functie:  . Tijd: 1 uur 2. Stel de maximale temperatuur in voor de functie:  . Tijd: 15 min
Schakel de oven uit en wacht tot deze is afgekoeld. Plaats de accessoires en de verwijderbare inschuifrails in de oven.		

6. DAGELIJKS GEBRUIK



WAARSCHUWING!







Raadpleeg de hoofdstukken Veiligheid.

6.1 Instellen: Verwarmingsfunctie

Stap 1	Draai aan de knop voor de verwarmingsfuncties om een verwarmingsfunctie te selecteren.
Stap 2	Draai aan de regelknop om de temperatuur te selecteren.
Stap 3	Draai wanneer het bereiden stopt aan de knoppen naar de uit-stand om de oven uit te schakelen.

6.2 Verwarmingsfuncties

Verwarmingsfunctie	Toepassing
0 Uit-positie	De oven staat uit.
 Binnenverlichting	Inschakelen van de verlichting.
 Hetelucht	Bakken op maximaal drie rekstanden tegelijkertijd en voedsel drogen. Stel de temperatuur 20 tot 40°C lager in dan voor Boven + onderwarmte.

Verwarmings-functie	Toepassing
	Voor het bakken van pizza. Voor intensieve bruining en een krokante bodem.
Pizza-functie	
	Voor het bakken en roosteren op één ovenniveau.
Boven + onder-warmte	
	Voor het bakken van taarten met een krokante bodem en het bewaren van voedsel.
Onderwarmte	
	Om voedsel te ontdooien (groenten en fruit). De ontdooitijd is afhankelijk van de hoeveelheid ingevroren voedsel en de grootte daarvan.
Ontdooien	
	Deze functie is ontworpen om tijdens de bereiding energie te besparen. Bij het gebruik van deze functie kan de temperatuur in de ruimte verschillen van de ingestelde temperatuur. De restwarmte wordt gebruikt. Het verwarmingsvermogen kan worden verminderd. Raadpleeg voor meer informatie het hoofdstuk "Dagelijks gebruik", opmerkingen op: Warmelucht (vochtig) .
Warmelucht (vochtig)	
	Om dunne stukken voedsel te grillen en brood te roosteren.
Grillen	

Verwarmings-functie	Toepassing
	Voor het braden van grote stukken vlees of gevogelte met bot op één niveau. Voor gratineren en bruinen.
Circulatiegrill	



De lamp kan tijdens bepaalde ovenfuncties automatisch uitgaan bij een temperatuur die lager is dan 60° C.

6.3 Opmerkingen over: Warmelucht (vochtig)



Deze functie werd gebruikt om te voldoen aan de eisen van de energie-efficiëntieklasse en het ecologisch ontwerp (volgens EU 65/2014 en EU 66/2014). Tests volgens: IEC/EN 60350-1.

De ovendeur dient tijdens de bereiding gesloten te zijn zodat de functie niet wordt onderbroken en de oven werkt op de hoogst mogelijke energie-efficiëntie.

Voor de bereidingsinstructies raadpleegt u het hoofdstuk "Aanwijzingen en tips", Warmelucht (vochtig) . Voor algemene aanbevelingen voor energiebesparing raadpleegt u het hoofdstuk "Energie-efficiëntie", Energiebesparing.

7. KLOKFUNCTIES



7.1 Klokfuncties

Klokfunctie	Toepassing
	Met deze functie kunt u de dagtijd instellen, wijzigen of controleren.
Dagtijd	
	Instellen hoe lang de oven in werking is.
Duur	
	Om een afteltijd in te stellen. Deze functie heeft geen invloed op de werking van de oven. U kunt deze functie op elk gewenst moment instellen, ook als de oven uit staat.
Kookwekker	

7.2 Instellen: Klokfuncties



Instellen: Dagtijd

 - knippert als je de oven aansluit op het stopcontact, als er een stroomstoring is geweest of als de timer niet is ingesteld.

 ,  - druk hierop om de tijd in te stellen.

Na ongeveer 5 seconden stopt het knipperen en geeft de klok de tijd weer.

Wijzigen: Dagtijd



Stap 1  - druk hier herhaaldelijk op om het tijdstip van de dag te wijzigen.  - begint te knipperen.

Stap 2  ,  - druk hierop om de tijd in te stellen.

Na ongeveer 5 seconden stopt het knipperen en geeft de klok de tijd weer.

Instellen: Duur

Stap 1 Stel een ovenfunctie en de temperatuur in.

Stap 2  - druk hier herhaaldelijk op.  - begint te knipperen.

Stap 3  ,  - druk hierop om de duur in te stellen.

Op het display verschijnt: .



 - knippert wanneer de ingestelde tijd is verstreken. Er weerklinkt een geluidssignaal en de oven schakelt uit.

Stap 4 Druk op een willekeurige toets om het signaal te stoppen.

Stap 5 Draai de knoppen naar de uitstand.

Instellen: Kookwekker

Stap 1  - druk hier herhaaldelijk op.  - begint te knipperen.

Stap 2  ,  - druk hierop om de tijd in te stellen.

De functie wordt automatisch na 5 seconden gestart.

Wanneer de ingestelde tijd is verstreken, klinkt er een geluidssignaal.

Stap 3 Druk op een willekeurige toets om het signaal te stoppen.

Stap 4 Draai de knoppen naar de uitstand.

Annuleren: Klokfuncties

Stap 1  - druk herhaaldelijk totdat het klokfunctiesymbool begint te knipperen.

Stap 2 Ingedrukt houden: .

De klokfunctie schakelt na enkele seconden uit.

8. GEBRUIK VAN DE ACCESSOIRES

WAARSCHUWING!

Raadpleeg de hoofdstukken Veiligheid.

8.1 Accessoires plaatsen

Een kleine inkeping bovenaan verhoogt de veiligheid. De inkepingen zijn ook anti-

kantelmechanismen. De hoge rand rond het rooster voorkomt dat het kookgerei van het rooster afglijdt.

Bakrooster:

Plaats het rooster tussen de geleidestangen van de roostersteun.

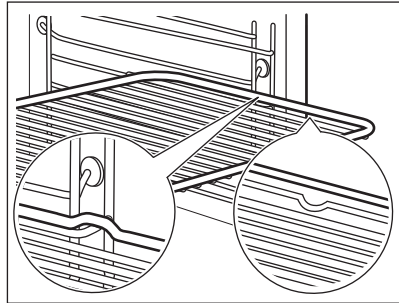

Bakplaat / Diepe schaal:

Schuif de plaat tussen de geleidestangen van de inschuifrail.

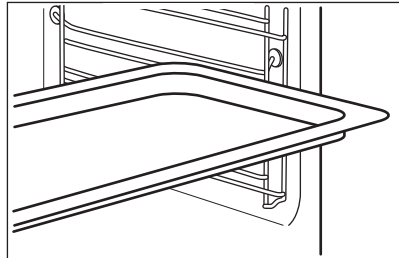

9. EXTRA FUNCTIES

9.1 Koelventilator

Als het apparaat in werking is, wordt de koelventilator automatisch ingeschakeld om de oppervlakken van het apparaat koel te

houden. Als je het apparaat uitschakelt, kan de koelventilator blijven werken totdat het apparaat is afgekoeld.

10. AANWIJZINGEN EN TIPS



Raadpleeg de hoofdstukken Veiligheid.

10.1 Kookadviezen



De temperatuur en kooktijden in de tabellen zijn slechts als richtlijn bedoeld. Ze zijn afhankelijk van het recept, de kwaliteit en de kwantiteit van de gebruikte ingrediënten.

Je apparaat kan anders bakken of roosteren dan het apparaat dat je tot nu toe gebruikt hebt. De onderstaande hints tonen aanbevolen instellingen voor temperatuur, kooktijd en rekstand voor specifieke soorten voedsel.

Als u voor een speciaal recept de instelling niet kunt vinden, zoek dan naar een soortgelijk recept.

10.2 Bakken

Gebruik voor de eerste baksessie de lagere temperatuur.

Bij het bereiden van cake op meerdere niveaus kan de baktijd ca. 10 - 15 minuten langer zijn.

Als de cake niet overal even hoog is, wordt de cake niet overal even bruin. Als de cake





niet overal even bruin wordt, hoeft u de temperatuurinstelling niet te wijzigen. De verschillen verminderen tijdens het bakken.

Tijdens het bakken kunnen bakplaten in de oven vervormen. Wanneer de bakplaten weer afgekoeld zijn, verdwijnt de vervorming.

10.3 Baktips

Bakresultaat	Mogelijke oorzaak	Oplossing
De onderkant van de cake is niet voldoende gebakken.	De rekstand is incorrect.	Plaats de cake op een lagere rekstand.
De cake zakt in en wordt klef, of streperig.	De oventemperatuur is te hoog.	Stel de volgende keer de oventemperatuur iets lager in.
	De oventemperatuur is te hoog en de baktijd te kort.	Stel volgende keer een langere baktijd en een lagere oventemperatuur in.
De cake is te droog.	De oventemperatuur is te laag.	Stel de volgende keer de oventemperatuur hoger in.
	Te lange baktijd.	Stel volgende keer een kortere baktijd in.
De cake wordt ongelijkmatig gebakken.	De oventemperatuur is te hoog en de baktijd te kort.	Stel volgende keer een langere baktijd en een lagere oventemperatuur in.
	Het cakebeslag is niet gelijkmatig verdeeld.	Verspreid de volgende keer het cakebeslag gelijkmatig over de bakplaat.
De cake wordt niet gaar binnen de in het recept aangegeven baktijd.	De oventemperatuur is te laag.	Stel de volgende keer de oventemperatuur iets hoger in.



10.4 Bakken op 1 rekniveau

 BAK- KEN IN BAK- VORMEN		 (°C)	 (min)	
Taartbodem - pasteijs, verwarm de lege oven voor	Hetelucht	170 - 180	10 - 25	2
Taartbodem - zacht cakedeeg	Hetelucht	150 - 170	20 - 25	2
Tulband / Brioche	Hetelucht	150 - 160	50 - 70	1
Zandgebak / Vruchtencakes	Hetelucht	140 - 160	70 - 90	1
Cheesecake	Boven + onderwarmte	170 - 190	60 - 90	1

Gebruik de derde rekstand.

Gebruik de functie: Hetelucht.





Gebruik een bakplaat.





 CAKE/GEBAK/BROOD	 (°C)	 (min)
Kruimeltaart, droog	150 - 160	20 - 40
Vruchtenvlaaien (gemaakt van gistdeeg/zacht cakedeeg), gebruik een diepe pan	150	35 - 55
Vruchtenvlaaien gemaakt van pasteijs	160 - 170	40 - 80

Verwarm de lege oven voor.





Gebruik de functie: Boven + onderwarmte.

Gebruik een bakplaat.

 CAKE/ GEBAK/BROOD	 (°C)	 (min)	
Biscuitrol	180 - 200	10 - 20	3
Roggebroomd:	eerst: 230	20	1
	dan: 160 - 180	30 - 60	
Beboterde amandeltaart / Suikerkoek	190 - 210	20 - 30	3
Roomsoezen / Eclairs	190 - 210	20 - 35	3
Plaatbrood / Broodkrans	170 - 190	30 - 40	3





 CAKE/ GEBAK/BROOD	 (°C)	 (min)	
Vruchtenvlaaijen (gemaakt van gistdeeg/zacht cake-deeg), gebruik een diepe pan	170	35 - 55	3
Plaatkoek met delicate garnering (bijvoorbeeld kwark, room, puddingvulling)	160 - 180	40 - 80	3
Kerststollen	160 - 180	50 - 70	2





Gebruik de derde rekstand.

 KOEKJES EN BISCUITS		 (°C)	 (min)
Zandkoekjes	Hetelucht	150 - 160	10 - 20
Broodjes, verwarm de lege oven voor	Hetelucht	160	10 - 25
Koekjes gemaakt van sponsdeeg	Hetelucht	150 - 160	15 - 20
Bladerdeeggebakjes, verwarm de lege oven voor	Hetelucht	170 - 180	20 - 30
Koekjes gemaakt van gistdeeg	Hetelucht	150 - 160	20 - 40
Bitterkoekjes	Hetelucht	100 - 120	30 - 50
Eiwitgebakjes/schuimgebakjes / Schuimgebakjes	Hetelucht	80 - 100	120 - 150
Broodjes, verwarm de lege oven voor	Boven + onderwarmte	190 - 210	10 - 25

10.5 Ovenschotels en gegratineerde gerechten

Gebruik de eerste rekstand.





		 (°C)	 (min)
Stokbrood bedekt met smeltkaas	Hetelucht	160 - 170	15 - 30
Groentegratin, verwarm de lege oven voor	Circulatiegrill	160 - 170	15 - 30
Lasagne	Boven + onderwarmte	180 - 200	25 - 40





		 (°C)	 (min)
Visschotels	Boven + onderwarmte	180 - 200	30 - 60
Gevulde groenten	Hetelucht	160 - 170	30 - 60
Zoete baksels	Boven + onderwarmte	180 - 200	40 - 60
Pasta gebakken	Boven + onderwarmte	180 - 200	45 - 60

10.6 Bakken op meerdere niveaus

Gebruik de functie: Hetelucht.

Gebruik de bakplaten.

 CAKE/ GEBAK	 (°C)	 (min)	 2 posities
Roomsoezen / Eclairs, verwarm de lege oven voor	160 - 180	25 - 45	1 / 4
Droge kruimeltaart	150 - 160	30 - 45	1 / 4

 KOEK- JES/CAKEJES/ GEBAK/BROOD- JES	 (°C)	 (min)	 2 posities	 3 posities
Broodjes	180	20 - 30	1 / 4	-
Zandkoekjes	150 - 160	20 - 40	1 / 4	1 / 3 / 5
Koekjes gemaakt van sponsdeeg	160 - 170	25 - 40	1 / 4	-
Bladerdeeggebak- jes, verwarm de lege oven voor	170 - 180	30 - 50	1 / 4	-
Koekjes gemaakt van gistdeeg	160 - 170	30 - 60	1 / 4	-
Bitterkoekjes	100 - 120	40 - 80	1 / 4	-
Koekjes gemaakt van eiwit / Schuim- gebakjes	80 - 100	130 - 170	1 / 4	-

10.7 Tips voor braden

Gebruik hittebestendig kookgerei.

Geroosterd mager vlees bedekt (u kunt aluminiumfolie gebruiken).

Rooster grote stukken vlees direct op de bakplaat.

Doe wat water in de bakplaat om te voorkomen dat druipend vet verbrandt.

Draai het braadstuk na 1/2 - 2/3 van de gaartijd.













Rooster vlees en vis in grote stukken (1 kg of meer).

Als niveau 1 wordt aanbevolen, plaatst u het voedsel direct op de bakplaat

Bedruip vleesstukken meerdere malen met hun eigen sap tijdens het roosteren.

10.8 Braden

Gebruik de eerste rekstand.

 RUNDVLEES				
			 (°C)	 (min)
Braadpan	1 - 1,5 kg	Boven + onder-warmte	230	120 - 150
Biefstuk of filet, rauw, verwarm de lege oven voor	per cm dikte	Circulatiegrill	190 - 200	5 - 6
Biefstuk of filet, medium, verwarm de lege oven voor	per cm dikte	Circulatiegrill	180 - 190	6 - 8
Biefstuk of filet, gaar, verwarm de lege oven voor	per cm dikte	Circulatiegrill	170 - 180	8 - 10
 VARKENSVLEES				
 Gebruik de functie: Circulatiegrill.				
	 (kg)	 (°C)	 (min)	
Schouder / Nek / Hamlap	1 - 1,5	160 - 180	90 - 120	
Chops / Spare rib	1 - 1,5	170 - 180	60 - 90	
Vleesbrood	0,75 - 1	160 - 170	50 - 60	
Varkensvlees, gare schenkel	0,75 - 1	150 - 170	90 - 120	



KALFSVLEES



Gebruik de functie: Circulatiegrill.



(kg)



(°C)



(min)

Geroosterd kalfsvlees

1

160 - 180

90 - 120

Kalfsschenkel

1,5 - 2

160 - 180

120 - 150



LAMSVLEES



Gebruik de functie: Circulatiegrill.



(kg)



(°C)



(min)

Lamspoot / Geroosterd lamsvlees

1 - 1,5

150 - 170

100 - 120

Lamsrugfilet

1 - 1,5

160 - 180

40 - 60



WILD



Gebruik de functie: Boven + onderwarmte.



(kg)



(°C)



(min)

Rug / Hazenspoot, verwarm de lege oven voor

tot 1

230

30 - 40

Hertenrugfilet

1,5 - 2

210 - 220

35 - 40

Reebout, hertenbout

1,5 - 2

180 - 200

60 - 90



GEVOGELTE



Gebruik de functie: Circulatiegrill.



(kg)



(°C)



(min)

Gevogelte, porties	0,2 - 0,25 elk	200 - 220	30 - 50
Halve kip	0,4 - 0,5 elk	190 - 210	35 - 50
Kip, poulard	1 - 1,5	190 - 210	50 - 70
Eend	1,5 - 2	180 - 200	80 - 100
Gans	3,5 - 5	160 - 180	120 - 180
Kalkoen	2,5 - 3,5	160 - 180	120 - 150
Kalkoen	4 - 6	140 - 160	150 - 240



VIS (GESTOOMD)



Gebruik de functie: Boven + onderwarmte.



(kg)



(°C)



(min)

Hele vis	1 - 1,5	210 - 220	40 - 60
----------	---------	-----------	---------

10.9 Knapperig bakken met: Pizza-functie



PIZZA



Gebruik de eerste rekstand.



(°C)



(min)

Taarten	180 - 200	40 - 55
Spinazievlaai	160 - 180	45 - 60
Quiche Lorraine / Zwitserse vlaai	170 - 190	45 - 55



PIZZA



Gebruik de eerste rekstand.



(°C)



(min)

Cheesecake	140 - 160	60 - 90
Groentetaart	160 - 180	50 - 60



PIZZA



Warm de lege oven voor het koken voor.



Gebruik de tweede rekstand.



(°C)



(min)

Pizza, dunne korst, gebruik een diepe pan

200 - 230

15 - 20

Pizza, dikke korst

180 - 200

20 - 30

Ongedesemd brood

230 - 250

10 - 20

Vlaai bladerdeeggebak

160 - 180

45 - 55



PIZZA



Warm de lege oven voor het koken voor.



Gebruik de tweede rekstand.



(°C)



(min)

Flammkuchen

230 - 250

12 - 20

Pierogi

180 - 200

15 - 25

10.10 Grillen

Warm de lege oven voor het koken voor.

Alleen dunne stukken vlees of vis grillen.

Plaats een pan op de eerste rekstand om vet op te vangen.



GRILLEN



Gebruik de functie: Grillen



(°C)



(min)

1e kant



(min)

2e kant



Biefstuk

210 - 230

30 - 40

30 - 40

2

Runderfilet

230

20 - 30

20 - 30

3

Varkenshaas

210 - 230

30 - 40

30 - 40

2

Kalfslende

210 - 230

30 - 40

30 - 40

2

Lamsrugfilet

210 - 230

25 - 35

20 - 25

3

Hele vis, 0,5 kg - 1 kg

210 - 230

15 - 30

15 - 30

3 / 4

10.11 Bevroren gerechten



ONTDOOIEN



Gebruik de functie: **Hetelucht.**



(°C)



(min)



	(°C)	(min)	
Pizza, bevroren	200 - 220	15 - 25	2
American pizza, bevroren	190 - 210	20 - 25	2
Pizza, gekoeld	210 - 230	13 - 25	2
Pizzasnacks, bevroren	180 - 200	15 - 30	2
Frietjes, dun	200 - 220	20 - 30	3
Frietjes, dik	200 - 220	25 - 35	3
Aardappelpartjes / Aardappelkroketjes	220 - 230	20 - 35	3
Rösties	210 - 230	20 - 30	3
Lasagne / Cannelloni, vers	170 - 190	35 - 45	2
Lasagne / Cannelloni, bevroren	160 - 180	40 - 60	2
Gebakken kaas	170 - 190	20 - 30	3
Kippenvleugels	190 - 210	20 - 30	2

10.12 Ontdooien

Haal het gerecht uit de verpakking en plaats het op een bord.

Dek het voedsel niet af, want dat kan de ontdooitijd verlengen.

Plaats voor grote porties voedsel een omgedraaid bord op de bodem van de

Gebruik het eerste ovenniveau.

ovenruimte. Leg het voedsel op een diepe schaal en zet deze bovenop het bord in de oven. Verwijder indien nodig de bakplaatsteunen.



(kg)



(min)
Ontdooitijd



(min)
Verdere ontdooi-
tijd







Kip

1

100 - 140

20 - 30

Halverwege de bereidingstijd omdraaien.

	 (kg)	 (min) Ontdooitijd	 (min) Verdere ontdooi- tijd	
Vlees	1	100 - 140	20 - 30	Halverwege de berei- dingstijd omdraaien.
Forel	0,15	25 - 35	10 - 15	-
Aardbeien	0,3	30 - 40	10 - 20	-
Boter	0,25	30 - 40	10 - 15	-
Room	2 x 0,2	80 - 100	10 - 15	Klop de nog licht bevro- ren slagroom.
Gebak	1,4	60	60	-

10.13 Inmaken

Gebruik de functie Onderwarmte.

Gebruik alleen weckpotten van dezelfde afmetingen.

Gebruik geen weckpotten met een draai- of bajonetsluiting en metalen bakken.

Gebruik de eerste rekstand.

Zet niet meer dan zes weckflessen van 1 liter op het bakrooster.



Vul de glazen potten gelijkmatig en sluit ze af met een klem.



De potten mogen elkaar niet aanraken.



Doe ongeveer 1/2 liter water in de bakplaat om voldoende vocht in de oven te geven.

Als de vloeistof in de weckpotten begint te borrelen (na ca. 35 - 60 minuten bij weckpotten van 1 liter), stop de oven of verlaag de temperatuur tot 100 °C (raadpleeg de tabel).

Stel de temperatuur in op 160 - 170 °C.

 ZACHTE VRUCHTEN	 (min) Kooktijd tot het sudderen begint
Aardbeien / Bosbessen / Frambozen / Rijpe kruisbessen	35 - 45

 STEEN-VRUCHTEN	 (min) Kooktijd tot het sudderen begint	 (min) Door blijven koken op 100 °C
Perziken / Kweeperen / Pruimen	35 - 45	10 - 15

 GROENTEN	 (min) Kooktijd tot het sudderen begint	 (min) Door blijven koken op 100 °C
Wortels	50 - 60	5 - 10
Komkommers	50 - 60	-
Gemengde augurken	50 - 60	5 - 10
Kohlrabi / Erwtten / Asperge	50 - 60	15 - 20



10.14 Drogen - Hetelucht

Bedek de bakplaten met vetbestendig papier of bakpapier.



Voor een beter resultaat, stop de oven halverwege de droogtijd, open de deur en laat het een nacht afkoelen om het drogen af te ronden.

Gebruik de derde rekstand voor 1 bakplaat.

Gebruik de eerste en de vierde rekstand voor 2 bakplaten.

 GROENTEN	 (°C)	 (u)
Bonen	60 - 70	6 - 8
Paprika's	60 - 70	5 - 6
Groenten voor soep	60 - 70	5 - 6
Paddenstoelen	50 - 60	6 - 8
Kruiden	40 - 50	2 - 3

Stel de temperatuur in op 60 - 70 °C.

 FRUIT	 (u)
Pruimen	8 - 10
Abrikozen	8 - 10
Appelplakjes	6 - 8
Peren	6 - 9

10.15 Warmelucht (vochtig) – aanbevolen accessoires

Gebruik de donkere en niet-reflecterende bakjes en schalen. Ze nemen de warmte beter op dan licht en reflecterend servies.



Pizza pan

Donker, niet-reflecterend
Diameter van 28 cm

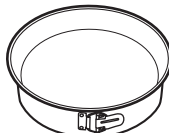

Ovenschaal

Donker, niet-reflecterend
Diameter van 26 cm



Ovenvorpjes

Keramik
8 cm diameter, 5
cm hoog







Blik voor flanbodern

Donker, niet-reflecterend
Diameter van 28 cm

10.16 Warmelucht (vochtig)





Volg voor de beste resultaten de volgende aanwijzingen op die hieronder in de tabel staan.

	 (°C)	 (min)	
Broodsticks, 0,5 kg in totaal	190 - 200	50 - 60	3
Sint-jakobsschelpen gebakken in hun schelp	180 - 200	30 - 40	4
Hele vis in zout, 0,3 - 0,5 kg	190 - 200	45 - 50	4
Hele vis in bakpapier, 0,3 - 0,5 kg	190 - 200	50 - 60	3
Amaretti (20; 0,5 kg in totaal)	170 - 180	40 - 50	3
Appelkruimel	190 - 200	50 - 60	4
Chocolade muffins (20; 0,5 kg in totaal)	160 - 170	35 - 45	3

10.17 Informatie voor testinstituten





Testen in overeenstemming met: EN 60350, IEC 60350.

Bakken op één niveau - bakken in bakblikken





		 °C	 min	
Zachte cake zonder vet	Hetelucht	160	45 - 60	2
Zachte cake zonder vet	Boven + onderwarmte	160	45 - 60	2
Appeltaart, 2 blikken Ø20 cm	Hetelucht	160	55 - 65	2
Appeltaart, 2 blikken Ø20 cm	Boven + onderwarmte	180	55 - 65	1
Zandtaartdeeg	Hetelucht	140	25 - 35	2
Zandtaartdeeg	Boven + onderwarmte	140	25 - 35	2

Bakken op één niveau - koekjes

Gebruik de derde rekstand.

		 °C	 min
Kleine cakes, 20 stuks per bakplaat, verwarm de lege oven voor	Hetelucht	150	20 - 30
Kleine cakes, 20 stuks per bakplaat, verwarm de lege oven voor	Boven + onderwarmte	170	20 - 30



Bakken op meerdere niveaus - koekjes

		 °C	 min	
Zandtaartdeeg	Hetelucht	140	25 - 45	2 / 4
Kleine cakes, 20 stuks per bakplaat, verwarm de lege oven voor	Hetelucht	150	25 - 35	1 / 4
Zachte cake zonder vet	Hetelucht	160	45 - 55	2 / 4
Appeltaart, 1 blik per rooster (Ø 20 cm)	Hetelucht	160	55 - 65	2 / 4

Grillen

Verwarm de lege oven 5 minuten voor.

Grill met de maximale temperatuurinstelling.

		 min	
Toast	Grillen	1 - 2	5
Biefstuk, halverwege de bereidings- tijd omdraaien	Grillen	24 - 30	4

11. ONDERHOUD EN REINIGING



WAARSCHUWING!

Raadpleeg de hoofdstukken Veiligheid.

11.1 Opmerkingen over de reiniging



Reinigingsmid-
delen

Reinig de voorkant van het apparaat uitsluitend met een microvezeldoek met warm water en een mild reinigingsmiddel.

Gebruik een reinigungsoplossing om metalen oppervlakken te reinigen.

Reinig vlekken met een mild reinigingsmiddel.



Dagelijks gebruik

Reinig de uitsparing telkens na gebruik. Vetophoping of andere resten kunnen brand veroorzaken.

Bewaar het voedsel niet langer dan 20 minuten in het apparaat. Droog de ruimte na elk gebruik uitsluitend met een microvezeldoek.



Accessoires

Reinig alle accessoires na elk gebruik en laat ze drogen. Gebruik alleen een zachte doek met warm water en een mild reinigingsmiddel. De accessoires niet in een afwasmachine reinigen.

Reinig de antiaanbakaccessoires niet met agressieve reinigungsmiddelen of scherpe voorwerpen.

11.2 Hoe te verwijderen: Inschuifrails/

Verwijder de inschuifrails om de oven te reinigen.

Stap 1 Schakel de oven uit en wacht totdat deze is afgekoeld.

Stap 2 Trek de inschuifrail bij de voorkant uit de zijwand.

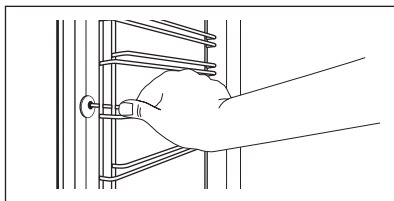

Stap 3 Trek de geleider bij de achterkant uit de zijwand en verwijder het.

Stap 4 Plaats de inschuifrails in omgekeerde volgorde.

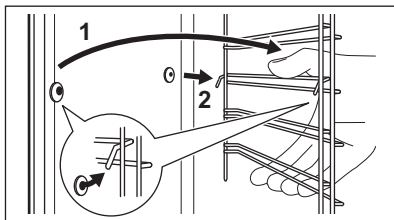

11.3 Hoe te verwijderen: Grill

WAARSCHUWING!

Gevaar voor brandwonden.

Stap 1 Zet de oven uit en wacht tot de oven afgekoeld is om deze schoon te maken. Verwijder de inschuifrails.

Stap 2 Pak de grillhoeken vast. Trek de grill naar voren tegen de veerdruk in en uit de twee houders. De grill klappt naar beneden.

Stap 3 Reinig het plafond van de oven met warm water, een zachte doek en een mild reinigingsmiddel. Laat de oven drogen.

Stap 4 Installeer de grill in de omgekeerde volgorde.

Stap 5 Installeer de inschuifrails.

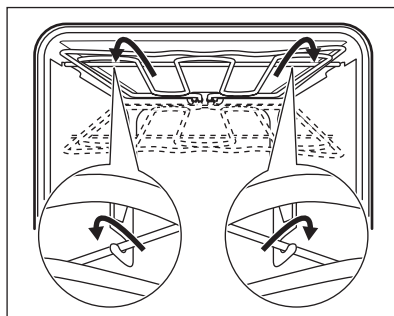

11.4 Verwijderen en installeren: Deur

U kunt de deur en de binnenste glasplaten verwijderen om ze te reinigen. U Het aantal glasplaten verschilt per model.

WAARSCHUWING!

De deur is zwaar.

LET OP!

Behandel het glas voorzichtig, vooral rond de randen van het voorpaneel. Het glas kan breken.

Stap 1 Open de deur volledig.

Stap 2 Hef en druk de klemhendels (A) op de twee deurscharnieren.

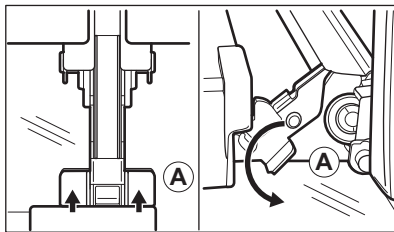

Stap 3 Sluit de oven deur in de eerste openingsstand (in een hoek van ongeveer 70°). Houd de deur aan beide kanten vast en trek deze onder een opwaartse hoek weg van de oven. Plaats de oven deur met de buitenkant omlaag op een zachte doek op een stabiele ondergrond.

Stap 4 Pak de deurafdekking (B) aan de bovenkant van de deur aan beide kanten vast en druk deze naar binnen om de klemsluiting te ontgrenzen.

Stap 5 Trek de deurlijst naar voren om hem te verwijderen.

Stap 6 Houd de glasplaten aan hun bovenkant vast en trek deze een voor een omhoog uit de geleider.

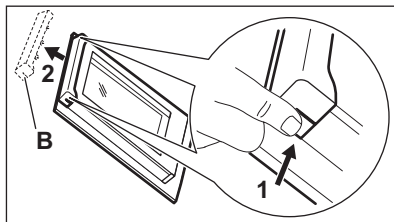

Stap 7 Reinig de glasplaat met een sopje. Droog de glasplaat voorzichtig af. Reinig de glasplaten niet in de vaatwasser.

Stap 8 Voer na het reinigen de bovenstaande stappen in de omgekeerde volgorde uit.

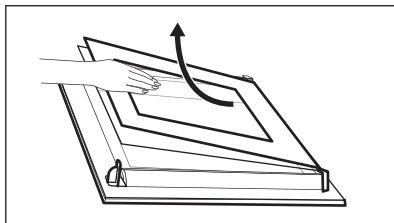

Stap 9 Plaats de kleinste glasplaat eerst, daarna de grotere glasplaat en de deur. Zorg ervoor dat de glasplaten op de juiste manier worden geplaatst, anders kan het oppervlak van de deur oververhit raken.

11.5 Hoe te vervangen: Lamp

⚠ WAARSCHUWING!

Gevaar voor elektrische schokken.
Het lampje kan heet zijn.

Voordat u de lamp vervangt:

Stap 1

Schakel de oven uit. Wacht tot de oven afgekoeld is.

Stap 2

Trek de oven uit het stopcontact.

Stap 3

Plaats een doek op de bodem van de holte.

Bovenlamp

Stap 1 Draai de glazen afdekking om die te verwijderen.

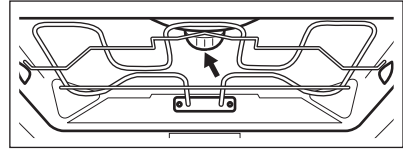

Stap 2 Reinig de glasafdekking.

Stap 3 Vervang de lamp door een geschikte 300 °C hittebestendige lamp.

Stap 4 Installeer het glazen deksel.

12. PROBLEEMOPLOSSING

WAARSCHUWING!

Raadpleeg de hoofdstukken Veiligheid.

12.1 Wat te doen als...

Neem in alle gevallen die niet in deze tabel zijn opgenomen contact op met een erkend servicecentrum.

Probleem	Controleer of de volgende zaken van toepassing zijn...
----------	--

De oven wordt niet warm.	De zekering is doorgeslagen.
--------------------------	------------------------------

Probleem	Controleer of de volgende zaken van toepassing zijn...
----------	--

Het display toont "12.00".	Er is een stroomstoring opgetreden. Stel de dag-tijd in.
----------------------------	--

De verlichting werkt niet.	De lamp is opgebrand.
----------------------------	-----------------------

12.2 Service-informatie

Als je niet zelf het probleem kunt verhelpen, neem dan contact op met je verkoper of een erkende serviceafdeling.

De contactgegevens van de servicedienst staan op het typeplaatje. Het typeplaatje bevindt zich op het voorframe van de apparaatruimte. Verwijder het typeplaatje niet uit de apparaatruimte.

Wij raden je aan om de gegevens hier te noteren:

Model (MOD.)

Productnummer (PNC)

Serienummer (S.N.)

13. ENERGIEZUINIGHEID

13.1 Productinformatie en productinformatieblad volgens de EU-voorschriften voor ecologisch ontwerp en energie-etikettering

Naam leverancier	AEG	
Modelnummer	BEK435060B 944188455 EB40B 944188534	
Energie-efficiëntie-index	81.2	
Energie-efficiëntieklasse	A+	
Energieverbruik met een standaard belading, conventionele modus	0.99kWh/cyclus	
Energieverbruik met een standaard belasting, heteluchtmodus	0.69kWh/cyclus	
Aantal holtes	1	
Warmtebron	Elektriciteit	
Volume	71l	
Soort oven	Inbouwoven	
Massa	BEK435060B	33.0kg
	EB40B	33.0kg

IEC/EN 60350-1 - Huishoudelijke elektrische kooktoestellen - Deel 1: Fornuizen, ovens, stoomovens en grills - Methoden voor het meten van prestaties.

13.2 Energiebesparing



Dit apparaat heeft functies die u helpen energie te besparen tijdens het dagelijks koken.

Zorg ervoor dat de deur van het apparaat gesloten is als het apparaat in werking is. Open de deur van het apparaat niet te vaak tijdens het koken. Houd het deurrubber schoon en zorg ervoor dat het goed op zijn plaats vastzit.

Gebruik metalen kookgerei om meer energie te besparen.

Verwarm het apparaat niet voor alvorens te koken als dat niet hoeft.

Houd onderbrekingen tussen het bakken zo kort mogelijk als je een aantal gerechten tegelijkertijd bereidt.

Koken met hete lucht

Gebruik indien mogelijk de bereidingsfuncties met hete lucht om energie te besparen.

Restwarmte

Wanneer de kookduur langer is dan 30 minuten, verlaag dan de oventemperatuur tot minimaal 3-10 minuten voor het einde van het koken. De restwarmte binnen in het apparaat zal blijven koken.

Je kunt de restwarmte gebruiken om andere maaltijden op te warmen.

Eten warm houden

Kies de laagst mogelijke temperatuurinstelling om de restwarmte te gebruiken en een maaltijd warm te houden.

Warmelucht (vochtig)

Functie is ontworpen om tijdens de bereiding energie te besparen.

14. MILIEUBESCHERMING

Recycleer de materialen met het symbool .
Gooi de verpakking in een geschikte afvalcontainer om het te recyclen.
Bescherm het milieu en de volksgezondheid en recycleer op een correcte manier het afval van elektrische en elektronische apparaten.

Gooi apparaten gemarkeerd met het symbool  niet weg met het huishoudelijk afval.
Breng het product naar het milieustation bij u in de buurt of neem contact op met de gemeente.

FOR PERFECT RESULTS

Thank you for choosing this AEG product. We have created it to give you impeccable performance for many years, with innovative technologies that help make life simpler – features you might not find on ordinary appliances. Please spend a few minutes reading to get the very best from it.

Visit our website to:



Get usage advice, brochures, trouble shooter, service and repair information:
www.aeg.com/support



Register your product for better service:
www.registeraeg.com



Buy Accessories, Consumables and Original spare parts for your appliance:
www.aeg.com/shop

CUSTOMER CARE AND SERVICE

Always use original spare parts.

When contacting our Authorised Service Centre, ensure that you have the following data available: Model, PNC, Serial Number.

The information can be found on the rating plate.

 Warning / Caution-Safety information

 General information and tips

 Environmental information

Subject to change without notice.

CONTENTS

1. SAFETY INFORMATION.....	59
2. SAFETY INSTRUCTIONS.....	60
3. PRODUCT DESCRIPTION.....	63
4. CONTROL PANEL.....	64
5. BEFORE FIRST USE.....	64
6. DAILY USE.....	65
7. CLOCK FUNCTIONS.....	66
8. USING THE ACCESSORIES.....	67
9. ADDITIONAL FUNCTIONS.....	68
10. HINTS AND TIPS.....	68
11. CARE AND CLEANING.....	80
12. TROUBLESHOOTING.....	83
13. ENERGY EFFICIENCY.....	84
14. ENVIRONMENTAL CONCERNS.....	85

1. ⚠ SAFETY INFORMATION

Before the installation and use of the appliance, carefully read the supplied instructions. The manufacturer is not responsible for any injuries or damage that are the result of incorrect installation or usage. Always keep the instructions in a safe and accessible location for future reference.

1.1 Children and vulnerable people safety

- This appliance can be used by children aged from 8 years and above and persons with reduced physical, sensory or mental capabilities or lack of experience and knowledge if they have been given supervision or instruction concerning the use of the appliance in a safe way and understand the hazards involved. Children of less than 8 years of age and persons with very extensive and complex disabilities shall be kept away from the appliance unless continuously supervised.
- Children should be supervised to ensure that they do not play with the appliance.
- Keep all packaging away from children and dispose of it appropriately.
- **WARNING:** The appliance and its accessible parts become hot during use. Keep children and pets away from the appliance when in use and when cooling down.
- If the appliance has a child safety device, it should be activated.
- Children shall not carry out cleaning and user maintenance of the appliance without supervision.

1.2 General Safety

- This appliance is for cooking purposes only.
- This appliance is designed for single household domestic use in an indoor environment.
- This appliance may be used in, offices, hotel guest rooms, bed & breakfast guest rooms, farm guest houses and other

similar accommodation where such use does not exceed (average) domestic usage levels.

- Only a qualified person must install this appliance and replace the cable.
- Do not use the appliance before installing it in the built-in structure.
- Disconnect the appliance from the power supply before carrying out any maintenance.
- If the supply cord is damaged, it must be replaced by the manufacturer, its Authorised Service Centre or similarly qualified persons to avoid an electrical hazard.
- **WARNING:** Ensure that the appliance is switched off before replacing the lamp to avoid the possibility of electric shock.
- **WARNING:** The appliance and its accessible parts become hot during use. Care should be taken to avoid touching heating elements or the surface of the appliance cavity.
- Always use oven gloves to remove or insert accessories or ovenware.
- To remove the shelf supports first pull the front of the shelf support and then the rear end away from the side walls. Install the shelf supports in the opposite sequence.
- Do not use a steam cleaner to clean the appliance.
- Do not use harsh abrasive cleaners or sharp metal scrapers to clean the glass door since they can scratch the surface, which may result in shattering of the glass.

2. SAFETY INSTRUCTIONS

2.1 Installation

 **WARNING!**

Only a qualified person must install this appliance.

- Remove all the packaging.
- Do not install or use a damaged appliance.
- Follow the installation instructions supplied with the appliance.
- Always take care when moving the appliance as it is heavy. Always use safety gloves and enclosed footwear.
- Do not pull the appliance by the handle.
- Install the appliance in a safe and suitable place that meets installation requirements.
- Keep the minimum distance from other appliances and units.
- Before mounting the appliance, check if the appliance door opens without restraint.
- The appliance is equipped with an electric cooling system. It must be operated with the electric power supply.

- The built-in unit must meet the stability requirements of DIN 68930.

Cabinet minimum height (Cabinet under the worktop minimum height)	578 (600) mm
Cabinet width	560 mm
Cabinet depth	550 (550) mm
Height of the front of the appliance	594 mm
Height of the back of the appliance	576 mm
Width of the front of the ap- pliance	595 mm
Width of the back of the ap- pliance	559 mm
Depth of the appliance	567 mm
Built in depth of the appli- ance	546 mm
Depth with open door	1027 mm
Ventilation opening mini- mum size. Opening placed on the bottom rear side	560x20 mm
Mains supply cable length. Cable is placed in the right corner of the back side	1500 mm
Mounting screws	4x25 mm

2.2 Electrical connection

WARNING!

Risk of fire and electric shock.

- All electrical connections should be made by a qualified electrician.
- The appliance must be earthed.
- Make sure that the parameters on the rating plate are compatible with the electrical ratings of the mains power supply.
- Always use a correctly installed shockproof socket.
- Do not use multi-plug adapters and extension cables.
- Make sure not to cause damage to the mains plug and to the mains cable. Should the mains cable need to be replaced, this

must be carried out by our Authorised Service Centre.

- Do not let mains cables touch or come near the appliance door or the niche below the appliance, especially when it operates or the door is hot.
- The shock protection of live and insulated parts must be fastened in such a way that it cannot be removed without tools.
- Connect the mains plug to the mains socket only at the end of the installation. Make sure that there is access to the mains plug after the installation.
- If the mains socket is loose, do not connect the mains plug.
- Do not pull the mains cable to disconnect the appliance. Always pull the mains plug.
- Use only correct isolation devices: line protecting cut-outs, fuses (screw type fuses removed from the holder), earth leakage trips and contactors.
- The electrical installation must have an isolation device which lets you disconnect the appliance from the mains at all poles. The isolation device must have a contact opening width of minimum 3 mm.
- This appliance is supplied with a main plug and a main cable.

2.3 Use

WARNING!

Risk of injury, burns and electric shock or explosion.

- Do not change the specification of this appliance.
- Make sure that the ventilation openings are not blocked.
- Do not let the appliance stay unattended during operation.
- Deactivate the appliance after each use.
- Be careful when you open the appliance door while the appliance is in operation. Hot air can release.
- Do not operate the appliance with wet hands or when it has contact with water.
- Do not apply pressure on the open door.
- Do not use the appliance as a work surface or as a storage surface.
- Open the appliance door carefully. The use of ingredients with alcohol can cause a mixture of alcohol and air.

- Do not let sparks or open flames to come in contact with the appliance when you open the door.
- Do not put flammable products or items that are wet with flammable products in, near or on the appliance.

⚠ WARNING!

Risk of damage to the appliance.

- To prevent damage or discoloration to the enamel:
 - do not put ovenware or other objects in the appliance directly on the bottom.
 - do not put aluminium foil directly on the bottom of cavity of the appliance.
 - do not put water directly into the hot appliance.
 - do not keep moist dishes and food in the appliance after you finish the cooking.
 - be careful when you remove or install the accessories.
- Discoloration of the enamel or stainless steel has no effect on the performance of the appliance.
- Use a deep pan for moist cakes. Fruit juices cause stains that can be permanent.
- Always cook with the appliance door closed.
- If the appliance is installed behind a furniture panel (e.g. a door) make sure the door is never closed when the appliance operates. Heat and moisture can build up behind a closed furniture panel and cause subsequent damage to the appliance, the housing unit or the floor. Do not close the furniture panel until the appliance has cooled down completely after use.

2.4 Care and cleaning

⚠ WARNING!

Risk of injury, fire, or damage to the appliance.

- Before maintenance, deactivate the appliance and disconnect the mains plug from the mains socket.
- Make sure the appliance is cold. There is the risk that the glass panels can break.

- Replace immediately the door glass panels when they are damaged. Contact the Authorised Service Centre.
- Be careful when you remove the door from the appliance. The door is heavy!
- Clean regularly the appliance to prevent the deterioration of the surface material.
- Clean the appliance with a moist soft cloth. Use only neutral detergents. Do not use abrasive products, abrasive cleaning pads, solvents or metal objects.
- If you use an oven spray, follow the safety instructions on its packaging.

2.5 Internal lighting

⚠ WARNING!

Risk of electric shock.

- Concerning the lamp(s) inside this product and spare part lamps sold separately: These lamps are intended to withstand extreme physical conditions in household appliances, such as temperature, vibration, humidity, or are intended to signal information about the operational status of the appliance. They are not intended to be used in other applications and are not suitable for household room illumination.
- This product contains a light source of energy efficiency class G.
- Use only lamps with the same specifications.

2.6 Service

- To repair the appliance contact the Authorised Service Centre.
- Use original spare parts only.

2.7 Disposal

⚠ WARNING!

Risk of injury or suffocation.

- Contact your municipal authority for information on how to dispose of the appliance.
- Disconnect the appliance from the mains supply.
- Cut off the mains electrical cable close to the appliance and dispose of it.

- Remove the door catch to prevent children or pets from becoming trapped in the appliance.

3. PRODUCT DESCRIPTION

3.1 General overview

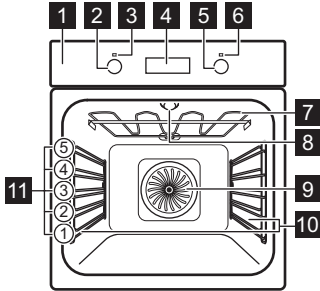

- 1 Control panel
- 2 Knob for the heating functions
- 3 Power lamp / symbol
- 4 Display
- 5 Control knob (for the temperature)
- 6 Temperature indicator / symbol
- 7 Heating element
- 8 Lamp
- 9 Fan
- 10 Shelf support, removable
- 11 Shelf positions

3.2 Accessories

Wire shelf

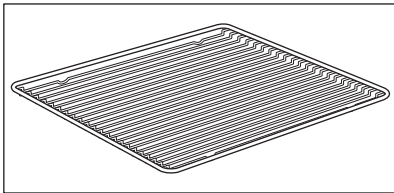

For cookware, cake tins, roasts.

Baking tray

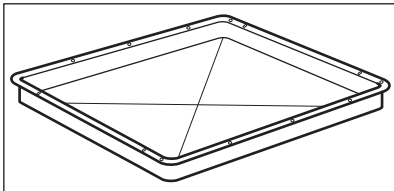

For cakes and biscuits.

Grill- / Roasting pan

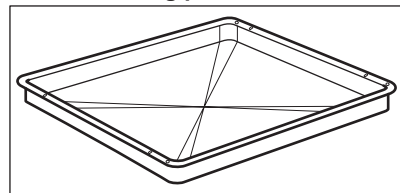

To bake and roast or as a pan to collect fat.

4. CONTROL PANEL

4.1 Retractable knobs

To use the appliance press the knob. The knob comes out.

4.2 Sensor fields / Buttons

—	To set the time.
🕒	To set a clock function.
+	To set the time.

4.3 Display

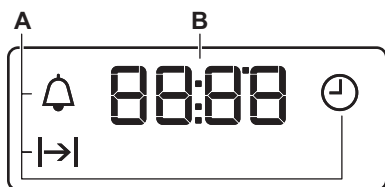

- A. Clock functions
- B. Timer

5. BEFORE FIRST USE

⚠️ WARNING!

Refer to Safety chapters.

5.1 Before first use

The oven can emit an odour and smoke during preheating. Make sure that the room is ventilated.



Step 1

Set the clock



Step 2

Clean the oven



Step 3

Preheat the empty oven

1. - press to set the time. After approximately 5 sec., the flashing stops and the display shows the time.

1. Remove all accessories and removable shelf supports from the oven.
2. Clean the oven and the accessories only with a microfibre cloth, warm water and a mild detergent.

1. Set the maximum temperature for the function: . Time: 1 h.
2. Set the maximum temperature for the function: . Time: 15 min.

Turn off the oven and wait until it is cold. Place the accessories and the removable shelf supports in the oven.

6. DAILY USE

WARNING!

Refer to Safety chapters.

6.1 How to set: Heating function

Step 1 Turn the knob for the heating functions to select a heating function.

Step 2 Turn the control knob to select the temperature.

Step 3 When the cooking ends, turn the knobs to the off position to turn off the oven.

6.2 Heating functions

Heating function	Application
------------------	-------------

0

Off position

The oven is off.



Light

To turn on the lamp.



True Fan Cooking

To bake on up to three shelf positions at the same time and to dry food. Set the temperature 20 - 40 °C lower than for Conventional Cooking.



Pizza Function

To bake pizza. To make intensive browning and a crispy bottom.

Heating function	Application
------------------	-------------



Conventional Cooking

To bake and roast food on one shelf position.



Bottom Heat

To bake cakes with crispy bottom and to preserve food.



Defrost

To defrost food (vegetables and fruit). The defrosting time depends on the amount and size of the frozen food.



Moist Fan Baking

This function is designed to save energy during cooking. When you use this function, the temperature in the cavity may differ from the set temperature. The residual heat is used. The heating power may be reduced. For more information refer to "Daily Use" chapter, Notes on: Moist Fan Baking.



Grill

To grill thin pieces of food and to toast bread.



Turbo Grilling

To roast large meat joints or poultry with bones on one shelf position. To make gratins and to brown.



The lamp may turn off automatically at a temperature below 60 °C during some oven functions.

6.3 Notes on: Moist Fan Baking

This function was used to comply with the energy efficiency class and ecodesign requirements (according to EU 65/2014 and EU 66/2014). Tests according to: IEC/EN 60350-1.



The oven door should be closed during cooking so that the function is not interrupted

and the oven operates with the highest energy efficiency possible.

For the cooking instructions refer to "Hints and tips" chapter, Moist Fan Baking. For general energy saving recommendations refer to "Energy Efficiency" chapter, Energy Saving.

7. CLOCK FUNCTIONS



7.1 Clock functions

Clock function	Application
 Time of Day	To set, change or check the time of day.
 Duration	To set how long the oven works.
 Minute Minder	To set a countdown. This function has no effect on the operation of the oven. You can set this function at any time, also when the oven is off.



7.2 How to set: Clock functions



How to set: Time of Day

 - flashes when you connect the oven to the electrical supply, when there was a power cut or when the timer is not set.

 ,  - press to set the time.
After approximately 5 sec., the flashing stops and the display shows the time.



How to change: Time of Day

Step 1  - press repeatedly to change the time of day.  - starts to flash.





Step 2  ,  - press to set the time.
After approximately 5 sec., the flashing stops and the display shows the time.

How to set: Duration





Step 1 Set an oven function and the temperature.

Step 2  - press repeatedly.  - starts to flash.



How to set: Duration

- Step 3**  ,  - press to set the duration.
The display shows: 
 - flashes when the set time ends. The signal sounds and the oven turns off.
- Step 4** Press any button to stop the signal.
- Step 5** Turn the knobs to the off position.

How to set: Minute Minder

- Step 1**  - press repeatedly.  - starts to flash.
- Step 2**  ,  - press to set the time.
The function starts automatically after 5 sec.
When the set time ends, the signal sounds.
- Step 3** Press any button to stop the signal.
- Step 4** Turn the knobs to the off position.

How to cancel: Clock functions

- Step 1**  - press repeatedly until the clock function symbol starts to flash.
- Step 2** Press and hold:  .
The clock function turns off after few seconds.

8. USING THE ACCESSORIES



WARNING!

Refer to Safety chapters.

8.1 Inserting accessories

A small indentation at the top increases safety. The indentations are also anti-tip

devices. The high rim around the shelf prevents cookware from slipping of the shelf.

Wire shelf:

Push the shelf between the guide bars of the shelf support.

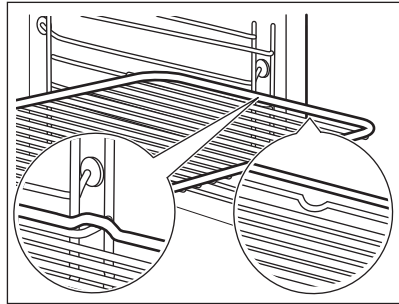

Baking tray / Deep pan:

Push the tray between the guide bars of the shelf support.

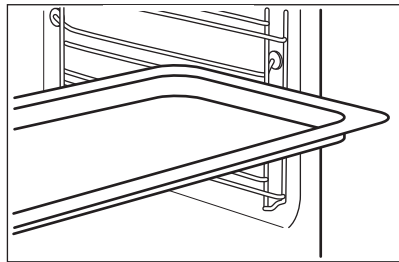

9. ADDITIONAL FUNCTIONS

9.1 Cooling fan

When the appliance operates, the cooling fan turns on automatically to keep the surfaces of

the appliance cool. If you turn off the appliance, the cooling fan can continue to operate until the appliance cools down.

10. HINTS AND TIPS



Refer to Safety chapters.

10.1 Cooking recommendations



The temperature and cooking times in the tables are guidelines only. They depend on the recipes and the quality and quantity of the ingredients used.

Your appliance may bake or roast differently to the appliance you had before. The hints below show recommended settings for temperature, cooking time and shelf position for specific types of the food.

If you cannot find the settings for a special recipe, look for the similar one.

10.2 Baking

For the first baking, use the lower temperature.

You can extend the baking time by 10 – 15 minutes if you bake cakes on more than one shelf position.

Cakes and pastries at different heights do not always brown equally. There is no need to





change the temperature setting if an unequal browning occurs. The differences equalize during baking.

Trays in the oven can distort during baking. When the trays are cold again, the distortions disappear.

10.3 Tips on baking

Baking results	Possible cause	Remedy
The bottom of the cake is not baked sufficiently.	The shelf position is incorrect.	Put the cake on a lower shelf.
The cake sinks and becomes soggy or streaky.	The oven temperature is too high.	Next time set slightly lower oven temperature.
	The oven temperature is too high and the baking time is too short.	Next time set a longer baking time and lower oven temperature.
The cake is too dry.	The oven temperature is too low.	Next time set higher oven temperature.
	The baking time is too long.	Next time set shorter baking time.
The cake bakes unevenly.	The oven temperature is too high and the baking time is too short.	Next time set a longer baking time and lower oven temperature.
	The cake batter is not evenly distributed.	Next time spread the cake batter evenly on the baking tray.
The cake is not ready in the baking time specified in a recipe.	The oven temperature is too low.	Next time set a slightly higher oven temperature.



10.4 Baking on one shelf level

 BAKING IN TINS		 (°C)	 (min)	
Flan base - short pastry, preheat the empty oven	True Fan Cooking	170 - 180	10 - 25	2
Flan base - sponge cake mixture	True Fan Cooking	150 - 170	20 - 25	2
Ring cake / Brioche	True Fan Cooking	150 - 160	50 - 70	1
Madeira cake / Fruit cakes	True Fan Cooking	140 - 160	70 - 90	1
Cheesecake	Conventional Cooking	170 - 190	60 - 90	1

Use the third shelf position.

Use the function: True Fan Cooking.





Use a baking tray.

 CAKES / PASTRIES / BREADS	 (°C)	 (min)
Cake with crumble topping	150 - 160	20 - 40
Fruit flans (made of yeast dough / sponge cake mixture), use a deep pan	150	35 - 55
Fruit flans made of short pastry	160 - 170	40 - 80





Preheat the empty oven.





Use the function: Conventional Cooking.

Use a baking tray.

 CAKES / PASTRIES / BREADS	 (°C)	 (min)	
Swiss roll	180 - 200	10 - 20	3
Rye bread:	first: 230	20	1
	then: 160 - 180	30 - 60	
Buttered almond cake / Sugar cakes	190 - 210	20 - 30	3
Cream puffs / Eclairs	190 - 210	20 - 35	3
Plaited bread / Bread crown	170 - 190	30 - 40	3
Fruit flans (made of yeast dough / sponge cake mixture), use a deep pan	170	35 - 55	3
Yeast cakes with delicate toppings (e.g. quark, cream, custard)	160 - 180	40 - 80	3
Christstollen	160 - 180	50 - 70	2





Use the third shelf position.

 BISCUITS		 (°C)	 (min)
Short pastry biscuits	True Fan Cooking	150 - 160	10 - 20
Rolls, preheat the empty oven	True Fan Cooking	160	10 - 25

 BISCUITS		 (°C)	 (min)
Biscuits made of sponge cake mixture	True Fan Cooking	150 - 160	15 - 20
Puff pastries, preheat the empty oven	True Fan Cooking	170 - 180	20 - 30
Biscuits made of yeast dough	True Fan Cooking	150 - 160	20 - 40
Macaroons	True Fan Cooking	100 - 120	30 - 50
Pastries made of egg white / Meringues	True Fan Cooking	80 - 100	120 - 150
Rolls, preheat the empty oven	Conventional Cooking	190 - 210	10 - 25

10.5 Bakes and gratins





Use the first shelf position.





		 (°C)	 (min)
Baguettes topped with melted cheese	True Fan Cooking	160 - 170	15 - 30
Vegetables au gratin, preheat the empty oven	Turbo Grilling	160 - 170	15 - 30
Lasagne	Conventional Cooking	180 - 200	25 - 40
Fish bakes	Conventional Cooking	180 - 200	30 - 60
Stuffed vegetables	True Fan Cooking	160 - 170	30 - 60
Sweet bakes	Conventional Cooking	180 - 200	40 - 60
Pasta bake	Conventional Cooking	180 - 200	45 - 60

10.6 Multilevel Baking

Use the function: True Fan Cooking.

Use the baking trays.

 CAKES / PASTRIES	 (°C)	 (min)	 2 positions
Cream puffs / Eclairs, preheat the empty oven	160 - 180	25 - 45	1 / 4
Dry streusel cake	150 - 160	30 - 45	1 / 4

 BIS- CUITS / SMALL CAKES / PAS- TRIES / ROLLS	 (°C)	 (min)		
			2 positions	3 positions
Rolls	180	20 - 30	1 / 4	-
Short pastry biscuits	150 - 160	20 - 40	1 / 4	1 / 3 / 5
Biscuits made of sponge cake mixture	160 - 170	25 - 40	1 / 4	-
Puff pastries, pre-heat the empty oven	170 - 180	30 - 50	1 / 4	-
Biscuits made of yeast dough	160 - 170	30 - 60	1 / 4	-
Macaroons	100 - 120	40 - 80	1 / 4	-
Biscuits made of egg white / Meringues	80 - 100	130 - 170	1 / 4	-

10.7 Tips on Roasting

Use heat-resistant ovenware.

Roast lean meat covered (you can use aluminium foil).

Roast large meat joints directly in the tray.

Put some water in the tray to prevent dripping fat from burning.

Turn the roast after 1/2 - 2/3 of the cooking time.







Roast meat and fish in large pieces (1 kg or more).

If level one is suggested put the food directly on the baking tray

Baste meat joints with their own juice several times during roasting.

10.8 Roasting

Use the first shelf position.

 BEEF					
				(°C)	(min)
Pot roast	1 - 1.5 kg	Conventional Cooking	230	120 - 150	
Roast beef or fillet, rare, preheat the empty oven	per cm of thickness	Turbo Grilling	190 - 200	5 - 6	
Roast beef or fillet, medium, preheat the empty oven	per cm of thickness	Turbo Grilling	180 - 190	6 - 8	
Roast beef or fillet, well done, preheat the empty oven	per cm of thickness	Turbo Grilling	170 - 180	8 - 10	



PORK



Use the function: Turbo Grilling.



(kg)



(°C)



(min)

Shoulder / Neck / Ham joint

1 - 1.5

160 - 180

90 - 120

Chops / Spare rib

1 - 1.5

170 - 180

60 - 90

Meatloaf

0.75 - 1

160 - 170

50 - 60

Pork knuckle, precooked

0.75 - 1

150 - 170

90 - 120



VEAL



Use the function: Turbo Grilling.



(kg)



(°C)



(min)

Roast veal

1

160 - 180

90 - 120

Veal knuckle

1.5 - 2

160 - 180

120 - 150



LAMB



Use the function: Turbo Grilling.



(kg)



(°C)



(min)

Lamb leg / Roast lamb

1 - 1.5

150 - 170

100 - 120

Lamb saddle

1 - 1.5

160 - 180

40 - 60



GAME



Use the function: **Conventional Cooking.**



(kg)



(°C)



(min)

Saddle / Hare leg, preheat the empty oven

up to 1

230

30 - 40

Venison saddle

1.5 - 2

210 - 220

35 - 40

Haunch of venison

1.5 - 2

180 - 200

60 - 90



POULTRY



Use the function: **Turbo Grilling.**



(kg)



(°C)



(min)

Poultry, portions

0.2 - 0.25 each

200 - 220

30 - 50

Chicken, half

0.4 - 0.5 each

190 - 210

35 - 50

Chicken, poulard

1 - 1.5

190 - 210

50 - 70

Duck

1.5 - 2

180 - 200

80 - 100

Goose

3.5 - 5

160 - 180

120 - 180

Turkey

2.5 - 3.5

160 - 180

120 - 150

Turkey

4 - 6

140 - 160

150 - 240



FISH (STEAMED)



Use the function: **Conventional Cooking.**



(kg)



(°C)



(min)







Whole fish







1 - 1.5







210 - 220

40 - 60

10.9 Crispy baking with: Pizza Function

 PIZZA		
 Preheat the empty oven before cooking.		
 Use the first shelf position.		
	 (°C)	 (min)
Tarts	180 - 200	40 - 55
Spinach flan	160 - 180	45 - 60
Quiche lorraine / Swiss flan	170 - 190	45 - 55
Cheesecake	140 - 160	60 - 90
Vegetable pie	160 - 180	50 - 60

 PIZZA		
 Preheat the empty oven before cooking.		
 Use the second shelf position.		
	 (°C)	 (min)
Pizza, thin crust, use a deep pan	200 - 230	15 - 20

 PIZZA		
 Preheat the empty oven before cooking.		
 Use the second shelf position.		
	 (°C)	 (min)
Pizza, thick crust	180 - 200	20 - 30
Unleavened bread	230 - 250	10 - 20
Puff pastry flan	160 - 180	45 - 55
Flammkuchen	230 - 250	12 - 20
Pierogi	180 - 200	15 - 25

10.10 Grill

Preheat the empty oven before cooking.

Grill only thin pieces of meat or fish.

Put a pan on the first shelf position to collect fat.



GRILL



Use the function: Grill



(°C)



(min)
1st side



(min)
2nd side



	(°C)	(min) 1st side	(min) 2nd side	
Roast beef	210 - 230	30 - 40	30 - 40	2
Beef fillet	230	20 - 30	20 - 30	3
Pork loin	210 - 230	30 - 40	30 - 40	2
Veal loin	210 - 230	30 - 40	30 - 40	2
Lamb saddle	210 - 230	25 - 35	20 - 25	3
Whole fish, 0.5 kg - 1 kg	210 - 230	15 - 30	15 - 30	3 / 4

10.11 Frozen Foods



DEFROSTING



Use the function: True Fan Cooking.



(°C)



(min)



	(°C)	(min)	
Pizza, frozen	200 - 220	15 - 25	2
Pizza American, frozen	190 - 210	20 - 25	2
Pizza, chilled	210 - 230	13 - 25	2
Pizza snacks, frozen	180 - 200	15 - 30	2
French fries, thin	200 - 220	20 - 30	3
French fries, thick	200 - 220	25 - 35	3
Wedges / Croquettes	220 - 230	20 - 35	3
Hash browns	210 - 230	20 - 30	3
Lasagne / Cannelloni, fresh	170 - 190	35 - 45	2
Lasagne / Cannelloni, frozen	160 - 180	40 - 60	2
Baked cheese	170 - 190	20 - 30	3
Chicken wings	190 - 210	20 - 30	2





10.12 Defrost

Remove the food packaging and put the food on a plate.

Do not cover the food, as this can extend the defrost time.

Use the first shelf position.

For large portions of food place an upturned empty plate on the bottom of the oven cavity. Put the food in a deep dish and set it on top of the plate inside the oven. Remove the shelf supports if necessary.

	 (kg)	 (min) Defrosting time	 (min) Further defrost- ing time	
Chicken	1	100 - 140	20 - 30	Turn halfway through.
Meat	1	100 - 140	20 - 30	Turn halfway through.
Trout	0.15	25 - 35	10 - 15	-
Strawberries	0.3	30 - 40	10 - 20	-
Butter	0.25	30 - 40	10 - 15	-
Cream	2 x 0.2	80 - 100	10 - 15	Whip the cream when still slightly frozen in places.
Gateau	1.4	60	60	-

10.13 Preserving

Use the function Bottom Heat.

Use only preserve jars of the same dimensions available on the market.

Do not use jars with twist-off and bayonet type lids or metal tins.

Use the first shelf position.

Put no more than six one-litre preserve jars on the baking tray.



Fill the jars equally and close with a clamp.



The jars cannot touch each other.



Put approximately 1/2 litre of water into the baking tray to give sufficient moisture in the oven.

When the liquid in the jars starts to simmer (after approximately 35 - 60 minutes with one-litre jars), stop the oven or decrease the temperature to 100 °C (see the table).

Set the temperature to 160 - 170 °C.

 SOFT FRUIT	 (min) Cooking time until simmering
Strawberries / Blueberries / Raspberries / Ripe goose- berries	35 - 45

 STONE FRUIT	 (min) Cooking time until simmer- ing	 (min) Continue to cook at 100 °C
Peaches / Quin- ces / Plums	35 - 45	10 - 15

 VEG-ETABLES	 (min) Cooking time until simmering	 (min) Continue to cook at 100 °C
Carrots	50 - 60	5 - 10
Cucumbers	50 - 60	-
Mixed pickles	50 - 60	5 - 10
Kohlrabi / Peas / Asparagus	50 - 60	15 - 20

10.14 Dehydrating - True Fan Cooking

Cover trays with grease proof paper or baking parchment.

For a better result, stop the oven halfway through the drying time, open the door and let it cool down for one night to complete the drying.

For 1 tray use the third shelf position.

For 2 trays use the first and fourth shelf position.

10.15 Moist Fan Baking - recommended accessories

Use the dark and non-reflective tins and containers. They have better heat absorption than the light colour and reflective dishes.



Pizza pan

Dark, non-reflective
28 cm diameter

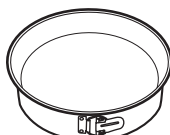

Baking dish

Dark, non-reflective
26 cm diameter



Ramekins

Ceramic
8 cm diameter, 5
cm height

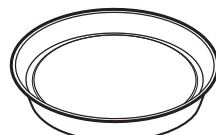



Flan base tin



Dark, non-reflective
28 cm diameter





10.16 Moist Fan Baking

For the best results follow suggestions listed in the table below.

 VEGETABLES	 (°C)	 (h)
Beans	60 - 70	6 - 8
Peppers	60 - 70	5 - 6
Vegetables for soup	60 - 70	5 - 6
Mushrooms	50 - 60	6 - 8
Herbs	40 - 50	2 - 3

Set the temperature to 60 - 70 °C.





 FRUIT	 (h)
Plums	8 - 10
Apricots	8 - 10
Apple slices	6 - 8
Pears	6 - 9

	 (°C)	 (min)	
Bread sticks, 0.5 kg in total	190 - 200	50 - 60	3
Baked scallops in shells	180 - 200	30 - 40	4
Whole fish in salt, 0.3 - 0.5 kg	190 - 200	45 - 50	4
Whole fish in parchment, 0.3 - 0.5 kg	190 - 200	50 - 60	3
Amaretti (20; 0.5 kg in total)	170 - 180	40 - 50	3
Apple crumble	190 - 200	50 - 60	4
Chocolate muffins (20; 0.5 kg in total)	160 - 170	35 - 45	3

10.17 Information for test institutes





Tests according to: EN 60350, IEC 60350.

Baking on one level - baking in tins





		 °C	 min	
Fatless sponge cake	True Fan Cooking	160	45 - 60	2
Fatless sponge cake	Conventional Cooking	160	45 - 60	2
Apple pie, 2 tins Ø20 cm	True Fan Cooking	160	55 - 65	2
Apple pie, 2 tins Ø20 cm	Conventional Cooking	180	55 - 65	1
Short bread	True Fan Cooking	140	25 - 35	2
Short bread	Conventional Cooking	140	25 - 35	2

Baking on one level - biscuits

Use the third shelf position.

		 °C	 min
Small cakes, 20 per tray, preheat the empty oven	True Fan Cooking	150	20 - 30
Small cakes, 20 per tray, preheat the empty oven	Conventional Cooking	170	20 - 30





Multilevel baking - biscuits

		 °C	 min	
Short bread	True Fan Cooking	140	25 - 45	2 / 4
Small cakes, 20 per tray, pre-heat the empty oven	True Fan Cooking	150	25 - 35	1 / 4
Fatless sponge cake	True Fan Cooking	160	45 - 55	2 / 4
Apple pie, 1 tin per grid (Ø 20 cm)	True Fan Cooking	160	55 - 65	2 / 4

Grill

Preheat the empty oven for 5 minutes.

Grill with the maximum temperature setting.

		 min	
Toast	Grill	1 - 2	5
Beef steak, turn halfway through	Grill	24 - 30	4

11. CARE AND CLEANING

WARNING!

Refer to Safety chapters.

11.1 Notes on cleaning



Cleaning Agents

Clean the front of the appliance only with a microfibre cloth with warm water and a mild detergent.

Use a cleaning solution to clean metal surfaces.

Clean stains with a mild detergent.



Everyday Use

Clean the cavity after each use. Fat accumulation or other residue may cause fire.

Do not store the food in the appliance for longer than 20 minutes. Dry the cavity only with a microfibre cloth after each use.



Clean all accessories after each use and let them dry. Use only a microfibre cloth with warm water and a mild detergent. Do not clean the accessories in a dishwasher.

Do not clean the non-stick accessories using abrasive cleaner or sharp-edged objects.

Accessories

11.2 How to remove: Shelf supports

Remove the shelf supports to clean the oven.

Step 1 Turn off the oven and wait until it is cold.

Step 2 Pull the front of the shelf support away from the side wall.

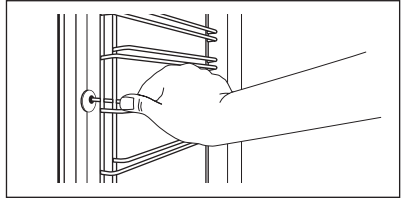

Step 3 Pull the rear end of the shelf support away from the side wall and remove it.

Step 4 Install the shelf supports in the opposite sequence.

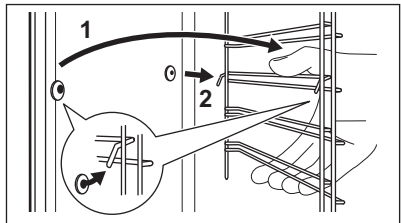

11.3 How to remove: Grill

WARNING!

There is a risk of burns.

Step 1 Turn off the oven and wait until it is cold to clean it.
Remove the shelf supports.

Step 2 Grab the grill corners. Pull it forwards against the spring pressure and out of two holders. The grill folds down.

Step 3 Clean the oven ceiling with warm water, a soft cloth and a mild detergent. Let it dry.

Step 4 Install the grill in the opposite sequence.

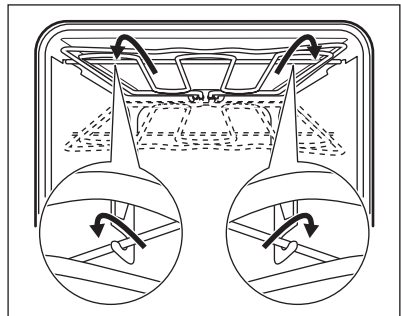

Step 5 Install the shelf supports.

11.4 How to remove and install: Door

You can remove the door and the internal glass panels to clean it. The number of glass panels is different for different models.

WARNING!

The door is heavy.

CAUTION!

Carefully handle the glass, especially around the edges of the front panel. The glass can break.

Step 1 Fully open the door.

Step 2 Lift and press the clamping levers (A) on the two door hinges.

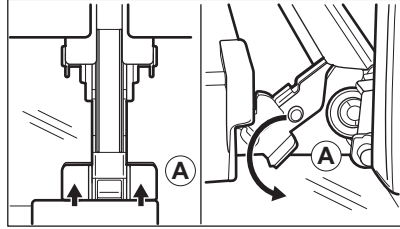

Step 3 Close the oven door to the first opening position (approximately 70° angle). Hold the door at both sides and pull it away from the oven at an upwards angle. Put the door with the outer side down on a soft cloth on a stable surface.

Step 4 Hold the door trim (B) on the top edge of the door at the two sides and push inwards to release the clip seal.

Step 5 Pull the door trim to the front to remove it.

Step 6 Hold the door glass panels on their top edge one by one and pull them up out of the guide.

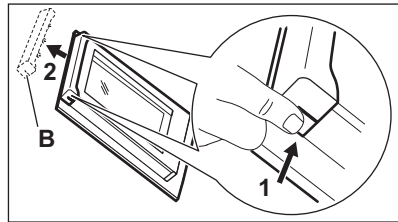

Step 7 Clean the glass panel with water and soap. Dry the glass panel carefully. Do not clean the glass panels in the dishwasher.

Step 8 After cleaning, do the above steps in the opposite sequence.

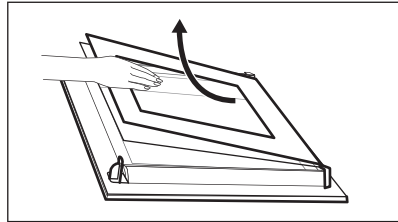

Step 9 Install the smaller panel first, then the larger and the door. Make sure that the glasses are inserted in the correct position otherwise the surface of the door may overheat.

11.5 How to replace: Lamp

WARNING!

Risk of electric shock.
The lamp can be hot.

Before you replace the lamp:

Step 1	Step 2	Step 3
Turn off the oven. Wait until the oven is cold.	Disconnect the oven from the mains.	Put a cloth on the bottom of the cavity.

Top lamp

Step 1 Turn the glass cover to remove it.

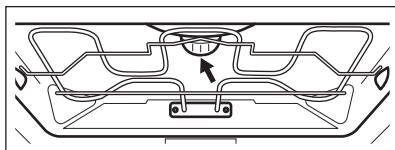

Step 2 Clean the glass cover.

Step 3 Replace the lamp with a suitable 300 °C heat-resistant lamp.

Step 4 Install the glass cover.

12. TROUBLESHOOTING

WARNING!

Refer to Safety chapters.

12.1 What to do if...

In any cases not included in this table please contact with an Authorised Service Centre.

Problem	Check if...
The oven does not heat up.	The fuse is blown.
The display shows "12.00".	There was a power cut. Set the time of day.
The lamp does not work.	The lamp is burnt out.

12.2 Service data

If you cannot find a solution to the problem yourself, contact your dealer or an Authorised Service Centre.

The necessary data for the service centre is on the rating plate. The rating plate is on the front frame of the appliance cavity. Do not remove the rating plate from the appliance cavity.

We recommend that you write the data here:

Model (MOD.)
Product number (PNC)
Serial number (S.N.)

13. ENERGY EFFICIENCY

13.1 Product Information and Product Information Sheet according to EU Ecodesign and Energy Labelling Regulations

Supplier's name	AEG	
Model identification	BEK435060B 944188455 EB40B 944188534	
Energy Efficiency Index	81.2	
Energy efficiency class	A+	
Energy consumption with a standard load, conventional mode	0.99 kWh/cycle	
Energy consumption with a standard load, fan-forced mode	0.69 kWh/cycle	
Number of cavities	1	
Heat source	Electricity	
Volume	71 l	
Type of oven	Built-In Oven	
Mass	BEK435060B	33.0 kg
	EB40B	33.0 kg

IEC/EN 60350-1 - Household electric cooking appliances - Part 1: Ranges, ovens, steam ovens and grills - Methods for measuring performance.

13.2 Energy saving



The appliance has features which help you save energy during everyday cooking.

Make sure that the appliance door is closed when the appliance operates. Do not open the appliance door too often during cooking. Keep the door gasket clean and make sure it is well fixed in its position.

Use metal cookware to improve energy saving.

When possible, do not preheat the appliance before cooking.

Keep breaks between baking as short as possible when you prepare a few dishes at one time.

Cooking with fan

When possible, use the cooking functions with fan to save energy.

Residual heat

When the cooking duration is longer than 30 min, reduce the appliance temperature to minimum 3 - 10 min before the end of cooking. The residual heat inside the appliance will continue to cook.

Use the residual heat to warm up other dishes.

Keep food warm

Choose the lowest possible temperature setting to use residual heat and keep a meal warm.

Moist Fan Baking

Function designed to save energy during cooking.

14. ENVIRONMENTAL CONCERNS

Recycle materials with the symbol . Put the packaging in relevant containers to recycle it. Help protect the environment and human health by recycling waste of electrical and electronic appliances. Do not dispose of

appliances marked with the symbol  with the household waste. Return the product to your local recycling facility or contact your municipal office.

TÄYDELLISIÄ TULOKSIA

Kiitos, kun valitsit tämän AEG-tuotteen. Olemme luoneet sen antamaan sinulle moitteettoman suorituskyvyn monien vuosien ajan innovatiivisilla tekniikoilla, jotka helpottavat elämää – nämä ovat ominaisuuksia, joita et ehkä löydä tavallisista laitteista. Käytä muutama minuutti aikaasi lukeaksesi, kuinka saat kaiken kaiken hyödyn irti laitteesta.

Vieraile verkkosivullamme:



Saat käyttöön liittyviä neuvoja, esitteitä, vianmääritysohjeita sekä huolto- ja korjausohjeita:

www.aeg.com/support



Rekisteröi tuotteesi saadaksesi parempaa huoltoa:

www.registeraeg.com



Osta laitteeseesi lisävarusteita, kulutustuotteita ja alkuperäisiä varaosia:

www.aeg.com/shop

ASIAKASPALVELU

Käytä aina alkuperäisiä varaosia.

Pidä seuraavat tiedot saatavilla ottaessasi yhteyttä valtuutettuun huoltoliikkeeseemme:

Malli, PNC-tuotenumero, sarjanumero.

Tiedot löytyvät arvokilvestä.

 Varoitus / Varotoimi- ja turvallisuustietoja

 Yleistietoa ja vinkkejä

 Ympäristönsuojelutietoja

Oikeus muutoksiin pidätetään.

SISÄLTÖ

1. TURVALLISUUSTIEDOT.....	87
2. TURVALLISUUSOHJEET.....	88
3. TUOTEKUVAUS.....	91
4. KÄYTTÖPANEELI.....	92
5. KÄYTTÖÖNOTTO.....	92
6. PÄIVITTÄINEN KÄYTTÖ.....	93
7. KELLOTOIMINNOT.....	94
8. LISÄVARUSTEIDEN KÄYTTÄMINEN.....	95
9. LISÄTOIMINNOT.....	96
10. VIHJEITÄ JA NEUVOJA.....	96
11. HOITO JA PUHDISTUS.....	108
12. VIANMÄÄRITYS.....	111
13. ENERGIATEHOKKUUS.....	112
14. YMPÄRISTÖNSUOJELU.....	113

1. ⚠️ TURVALLISUUSTIEDOT

Lue laitteen mukana toimitetut ohjeet ennen laitteen asennusta ja käyttöä. Valmistaja ei ota vastuuta henkilövahingoista tai vahingoista, jotka aiheutuvat virheellisestä asennuksesta tai käytöstä. Säilytä ohjeita aina varmassa ja helppopääsyisessä paikassa tulevia käyttökertoja varten.

1.1 Lasten ja taitamattomien henkilöiden turvallisuus

- 8-vuotiaat ja sitä vanhemmat lapset sekä henkilöt, joilla on fyysisiä, aisteihin liittyviä tai henkisiä rajoitteita tai puutteellinen kokemus tai tuntemus, voivat käyttää tätä laitetta vain, jos heitä valvotaan tai ohjataan laitteen turvallisessa käytössä ja jos he ymmärtävät käyttöön liittyvät vaarat. Tuote on pidettävä alle 8-vuotiaiden lasten ja erittäin laajoista ja monimutkaisista toiminnallisista rajoitteista kärsivien henkilöiden ulottumattomissa, ellei heitä valvota jatkuvasti.
- Lapsia on valvottava, jotta he eivät ryhdy leikkimään laitteella.
- Kaikki pakkaukset tulee pitää lasten ulottumattomissa ja hävittää asianmukaisesti.
- VAROITUS: Uuni ja sen esilläolevat osat kuumentuvat käytön aikana. Pidä lapset ja lemmikkieläimet poissa laitteen lähetyviltä sen ollessa toiminnassa tai jäähtymässä.
- Jos laitteessa on lapsilukko, sitä on käytettävä.
- Lapset eivät saa puhdistaa laitetta tai suorittaa siihen kohdistuvia käyttäjän huoltotoimenpiteitä ilman valvontaa.

1.2 Yleinen turvallisuus

- Tämä laite on tarkoitettu ainoastaan ruoanlaittoon.
- Tämä laite on tarkoitettu yhden kotitalouden käyttöön sisätiloissa.

- Tätä laitetta voidaan käyttää toimistoissa, hotellihuoneissa, aamiaismajoituspaikoissa, maatilamajoituspaikoissa ja muissa samantyyppisissä majoitustiloissa, joissa kyseinen käyttö ei ylitä (keskimääräisiä) kotitalouskäytön tasoja.
- Laitteen asennuksen ja virtajohdon vaihtamisen saa suorittaa vain alan ammattilainen.
- Älä käytä laitetta ennen kuin se on asennettu kalusteeseen.
- Irrota laite sähköverkosta ennen huoltotoimenpiteiden suorittamista.
- Jos virtajohto vaurioituu, sen saa vaihtaa vain valmistaja, valtuutettu huoltoliike tai vastaava ammattitaitoinen henkilö, jotta vältytään sähkövaaroilta.
- VAROITUS: Varmista, että laite on kytketty pois päältä ennen kuin ryhdyt vaihtamaan lampua välttääksesi sähköiskun vaaran.
- VAROITUS: Uuni ja sen esilläolevat osat kuumentuvat käytön aikana. Vältä koskettamasta lämpövastuksia tai laitteen sisätilan pintoja.
- Käytä suojakäsineitä poistaessasi varusteita tai uunivuokia tai asettaessasi niitä laitteen sisälle.
- Poista hyllytuet vetämällä ensin hyllytuen etuosa ja sitten takaosa irti sivuseinistä. Asenna hyllytuet päinvastaisessa järjestyksessä.
- Laitteen puhdistuksessa ei saa käyttää höyrypesuria.
- Älä käytä hankausaineita tai teräviä metallikaapimia lasiluukun puhdistamisessa, sillä ne voivat naarmuttaa pintaa, mistä voi olla seurauksena lasin särkyminen.

2. TURVALLISUUSOHJEET

2.1 Asennus



VAROITUS!

Asennuksen saa suorittaa vain ammattitaitoinen henkilö.

- Poista kaikki pakkausmateriaalit.
- Vaurioitunutta laitetta ei saa asentaa tai käyttää.

- Noudata koneen mukana toimitettuja asennusohjeita.
- Siirrä laitetta aina varoen, sillä se on raskas. Käytä aina suojakäsineitä ja suojaavia jalkineita.
- Älä koskaan vedä laitetta sen kahvasta kiinni pitäen.
- Asenna laite turvalliseen ja sopivaan paikkaan, joka täyttää asennusvaatimukset.

- Noudata mainittuja vähimmäisetäisyyksiä muihin laitteisiin ja kalusteisiin.
- Tarkista ennen laitteen asentamista, että laitteen luukku avautuu esteettä.
- Laite on varustettu sähkötoimisella jäähdytysjärjestelmällä. Sitä on käytettävä sähkösyötöllä.
- Kalusteisiin asennettavan yksikön on täytettävä standardin DIN 68930 asettamat vaatimukset.

Kaapin vähimmäiskorkeus (työtason alla olevan kaapin vähimmäiskorkeus)	578 (600) mm
Kaapin leveys	560 mm
Kaapin syvyys	550 (550) mm
Laitteen etuosan korkeus	594 mm
Laitteen takaosan korkeus	576 mm
Laitteen etuosan leveys	595 mm
Laitteen takaosan leveys	559 mm
Laitteen syvyys	567 mm
Laitteen asennussyvyys	546 mm
Leveys luukun ollessa auki	1027 mm
Tuuletusaukon vähimmäiskoko. Aukko alaosassa takana	560x20 mm
Virtajohdon pituus. Johto sijaitsee oikeassa kulmassa takana	1500 mm
Kiinnitysruuvit	4x25 mm

2.2 Sähkökytkentä



VAROITUS!

Tulipalo- ja sähköiskuvaara.

- Kaikki sähkökytkennät tulee jättää asiantuntevan sähköasentajan vastuulle.
- Laite on kytkettävä maadoitettuun pistorasiaan.
- Varmista, että arvokilvessä olevat parametrit ovat verkkovirtalähteen sähköarvojen mukaisia.
- Kytke pistoke maadoitettuun pistorasiaan.
- Älä käytä jakorasioita tai jatkojohtoja.
- Varmista, ettei pistoke ja virtajohto vaurioidu. Jos virtajohto joudutaan

vaihtamaan, vaihdon saa suorittaa vain valtuutettu huoltoliike.

- Älä anna virtajohtojen koskettaa laitteen luukkuun tai päästä niitä luukun tai laitteen alapuolella olevan asennustilan lähelle, varsinkaan laitteen ollessa toiminnassa tai luukun ollessa kuuma.
- Jännitteenalaisten ja eristettyjen osien suojat tulee asentaa niin, ettei niiden irrotus onnistu ilman työkaluja.
- Kytke pistoke pistorasiaan vasta asennuksen jälkeen. Varmista, että laitteen verkkovirtakytkentä on ulottuvilla laitteen asennuksen jälkeen.
- Jos pistoke on löysästi kiinni virtajohdossa, älä kiinnitä sitä pistorasiaan.
- Älä vedä virtajohdosta pistoketta irrottaessasi. Vedä aina pistokkeesta.
- Käytä vain asianmukaisia eristyslaitteita: suojakytkimet, sulakkeet (ruuvattavat sulakkeet on irrotettava kannasta), vikavirtakytkimet ja kontaktorit.
- Sähköasennuksessa on oltava erotin, joka mahdollistaa laitteen irrottamisen sähköverkosta kaikista navoista. Erottimen kontaktiaukon leveys on oltava vähintään 3 mm.
- Laitteen mukana toimitetaan päävirtajohto ja pääpistoke.

2.3 Valitse



VAROITUS!

Henkilövahinkojen, palovammojen ja sähköiskujen tai räjähdysvaara.

- Älä muuta laitteen teknisiä ominaisuuksia.
- Varmista, että tuuletusaukoissa ei ole tukoksia.
- Laitetta ei saa jättää päälle valvomatta.
- Kytke laite pois päältä jokaisen käyttökerran jälkeen.
- Noudata varovaisuutta avatessasi laitteen luukun laitteen ollessa toiminnassa. Laitteesta voi purkautua ulos kuumaa ilmaa.
- Älä käytä laitetta, jos kätesi ovat märät tai laitteen ollessa kosketuksessa veteen.
- Älä kohdista painetta avoimeen oveen.
- Älä käytä laitetta työtasona tai tavaroiden säilytystasona.

- Avaa laitteen luukku varovaisuutta noudattaen. Alkoholi- ja pitoisten ainesosien käyttämisen tuloksena voi muodostua alkoholin ja ilman seoksia.
- Älä päästä kipinöitä tai avotulta kosketukseen laitteen kanssa avatessasi sen luukun.
- Älä aseta helposti syttyviä tuotteita tai helposti syttyvien aineiden kanssa kosketuksissa olleita tuotteita laitteeseen, laitteen päälle tai sen lähelle.

VAROITUS!

Laite voi muutoin vaurioitua.

- Estä emalipinnan vaurioituminen tai haalistuminen:
 - Älä aseta ruoanlaittovälineitä tai muita esineitä laitteeseen siten, että ne olisivat suorassa kosketuksessa laitteen pohjan kanssa.
 - Älä aseta alumiinifoliota siten, että se olisi suorassa kosketuksessa laitteen pohjan kanssa.
 - Älä laita vettä suoraan kuumaan laitteeseen.
 - Älä säilytä kosteita astioita tai ruokia laitteessa lopetettuasi ruoanlaiton.
 - Noudata varovaisuutta poistaessasi tai asentaessasi lisäosia.
- Uunin emalipintojen tai ruostumattoman teräksen värimuutokset eivät vaikuta laitteen toimintaan.
- Käytä syvää pannua kosteita kakkuja paistaessasi. Hedelmämehut voivat jättää pysyviä tahroja.
- Laitteen luukku on pidettävä suljettuna käytön aikana.
- Jos laite asennetaan kalusteen paneelin (esim. oven) taakse, ovea ei saa koskaan sulkea laitteen ollessa toiminnassa. Lämpöä tai kosteutta voi kertyä suljetun kalusteen paneelin taakse ja laite, kalusteet tai lattia voivat sen seurauksena vaurioitua. Älä sulje kalusteen paneelia ennen kuin laite on täysin jäähtynyt käytön jälkeen.

2.4 Hoito ja puhdistus

VAROITUS!

Ne voivat aiheuttaa henkilövahinkoja, tulipaloja tai laitteen vaurioitumisen.

- Kytke laite pois toiminnasta ja irrota pistoke pistorasiasta ennen ylläpito- ja huolto-työaloitusta.
- Tarkista, että laite on kylmä. Vaarana on lasilevyjen rikkoutuminen.
- Vaihda välittömästi vaurioituneet luukun lasipaneelit. Ota yhteyttä valtuutettuun huoltoliikkeeseen.
- Ole varovainen irrottaessasi luukkuja. Luukku on painava!
- Puhdista laite säännöllisesti, jotta pintamateriaali ei vaurioidu.
- Puhdista laite kostealla pehmeällä liinalla. Käytä ainoastaan mietoja pesuaineita. Älä käytä hankausainetta, hankaavia pesulappuja, liuottimia tai metalliesineitä.
- Jos käytät uuninpuhdistussuihketta, noudata tuotepakkauksessa olevia turvallisuusohjeita.

2.5 Sisävalaistus

VAROITUS!

Sähköiskun vaara.

- Lisätietoa tämän tuotteen sisällä olevista lamppuista sekä erikseen myytävistä varalampuista: Kyseiset lamput on suunniteltu kestämaan kodinkoneissa vaativia fyysisiä olosuhteita (esim. lämpötila, värinä, kosteus) tai ne antavat tietoa laitteen toimintatilasta. Niitä ei ole tarkoitettu muihin käyttötarkoituksiin eivätkä ne sovi huoneiden valaisemiseen.
- Tämä tuote sisältää valonlähteen, jonka energiatehokkuusluokka on G.
- Käytä ainoastaan ominaisuuksiltaan samanlaisia lamppuja.

2.6 Huolto

- Laitteen korjaukseen liittyvissä asioissa tulee ottaa yhteyttä valtuutettuun huoltopalveluun.
- Ainoastaan alkuperäisiä varaosia saa käyttää.

2.7 Hävittäminen

VAROITUS!

Henkilövahinko- tai tukehtumisvaara.

- Kysy tietoja laitteen oikeaoppisesta hävittämisestä paikalliselta viranomaiselta.

- Irrota pistoke pistorasiasta.
- Leikkaa virtajohto laitteen läheltä ja hävitä se.
- Poista luukun lukitus, jotta lapset, tai lemmikit eivät jäisi loukkuun laitteen sisälle.

3. TUOTEKUVAUS

3.1 Yleiskatsaus

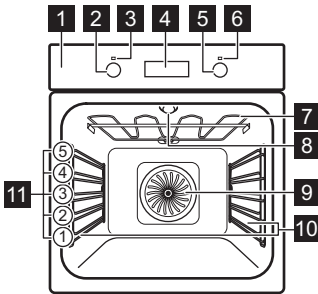

- 1 Käyttöpaneeli
- 2 Uunitoimintojen kiertonuppi
- 3 Virran merkivalo / symboli
- 4 Näyttö
- 5 Säätonuppi (lämpötilan valitsemiseen)
- 6 Lämpötilan merkivalo / symboli
- 7 Lämpövastus
- 8 Lamppu
- 9 Puhallin
- 10 Hyllykannatin, irrotettava
- 11 Hyllytasot

3.2 Varusteet

Paistoritilä

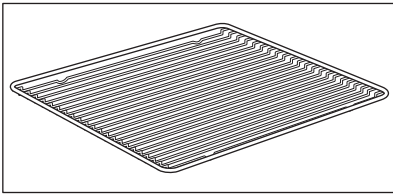

Ruoanlaittovälineille, kakkuvuokat, paistit.

Paistolevy

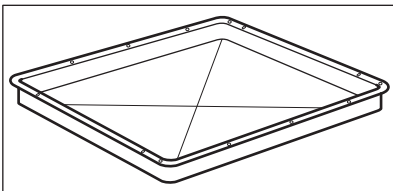

Kakuille ja kekseille.

Grilli / uunipannu

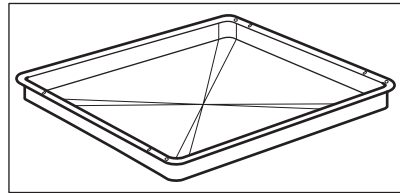

Paistamiseen tai pannuna rasvan keräämiseen.

4. KÄYTTÖPANEELI

4.1 Sisäänpainettava vääntimet

Paina väännintä käyttäaksesi laitetta.
Väännin tulee ulos.

4.2 Kosketuspainikkeet/painikkeet

—	Ajan asettaminen.
🕒	Kellotoiminnon asettaminen.
+	Ajan asettaminen.

4.3 Näyttö

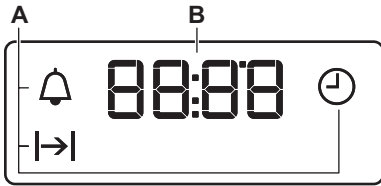

- A. Kellotoiminnot
B. Ajastin





5. KÄYTTÖÖNOTTO

⚠️ VAROITUS!

Lue turvallisuutta koskevat luvut.

5.1 Ennen ensimmäistä käyttökertaa

Uunista voi tulla hajua ja savua esikuumennuksen aikana. Varmista huoneen hyvä tuuletus.

 1. vaihe	 2. vaihe	 3. vaihe
Aseta kello	Puhdista uuni	Esikuumenna tyhjä uuni
1. +, — - paina asettaaksesi aika. Vilkkuminen lakkaa noin 5 sekunnin kuluttua ja näytössä näkyy aika.	1. Poista kaikki varusteet ja irrotettavat uunipeltien kannattimet uunista. 2. Puhdista uuni ja sen varusteet pelkällä lämpimällä vedellä ja miedolla pesuaineella mikrokiutuliinaa käyttäen.	1. Aseta toiminnon enimmäislämpötila:  : Aika: 1 tunti. 2. Aseta toiminnon enimmäislämpötila:  : Aika: 15 min.

Kytke uuni pois päältä ja odota, että se jäähtyy. Aseta varusteet ja irrotettavat uunipeltien kannattimet uuniin.

6. PÄIVITTÄINEN KÄYTTÖ







VAROITUS!





Lue turvallisuutta koskevat luvut.

6.1 Asettaminen: Uunitoiminto

- 1. vaihe** Käännä uunin toimintojen väännintä uunitoiminnon valitsemiseksi.
- 2. vaihe** Valitse lämpötila kääntämällä väännintä.
- 3. vaihe** Kun ruoka on valmista, käännä väännintä Off-asentoon uunin sammuttamiseksi.

6.2 Uunitoiminnot

Uunitoiminto	Käyttökohde
 Pois päältä -asento	Uuni on kytketty pois päältä.
 Valo	Lampun sytyttäminen.
 Kuumennettu kiertoilma	Korkeintaan kolmella kannatintasolla kypsentäminen samanaikaisesti ja ruokien kuivaus. Lämpötila asetettava 20–40 °C matalammaksi kuin toiminnossa Ylä-/alalämpö.
 Pizza-toiminto	Pizzan valmistaminen. Voimakkaaseen ruskistamiseen ja nopean pohjan luomiseen.
 Ylä-/alalämpö	Kypsentäminen ja paistaminen yhdellä tasolla.
 Alalämpö	Kakkujen paistamiseksi rapealla pohjalla ja ruoan säilömiseksi.

Uunitoiminto	Käyttökohde
 Sulatus	Ruoan, (hedelmien ja vihannesten) sulattaminen. Sulatusaikaan vaikuttavat pakastetun ruoan määrä ja koko.
 Kosteaa kiertoilma	Tämä toiminto säästää energiaa ruoanlaiton aikana. Kun käytät tätä toimintoa, uunin sisälämpötila voi poiketa lämpötila-asetuksesta. Jälkilämpötilaa käytetään. Kuumennusteho voi laskea. Katso lisätietoa luvusta "Päivittäinen käyttö", Huomautus: Kosteaa kiertoilma.
 Grilli	Ohuiden ruokien grillaus ja leivän paahdaminen.
 Tehogrillaus	Isohkojen, luisten liha- tai lintupaistien paistamiseen yhdessä ritiläasennossa. Gratinointi ja ruskistus.



Joissakin uunitoiminnoissa lamppu voi sammua automaattisesti alle 60 °C lämpötilassa.

6.3 Huomautuksia: Kosteaa kiertoilma



Tämän toiminnon avulla määritettiin energiatehokkuusluokka (vastaamaan standardeja EU 65/2014 ja EU 66/2014). Testit standardin IEC/EN 60350-1 mukaisesti.

Uunin luukun on oltava kiinni ruoanlaiton aikana, jotta toiminto ei keskeytyisi ja uunin energiatehokkuus olisi mahdollisimman suuri.

Ruoanlaitto-ohjeet ovat luvussa "Neuvoja ja vinkkejä" kohdassa Kosteaa kiertoilma. Yleissuosituksia energian säästämiseksi on luvussa "Energiatehokkuus".

7. KELLOTOIMINNOT

7.1 Kellotoiminnot

Kellotoiminto	Käyttötarkoitus
 Kellonaika	Kellonajan asettaminen, muuttaminen tai tarkistaminen.
 Kesto	Uunin toiminta-ajan asettaminen.
 Hälytinajastin	Ajastimen asettaminen. Tämä toiminto ei vaikuta millään tavalla uunin toimintaan. Tämä toiminto voidaan asettaa milloin tahansa, myös uunin ollessa pois päältä.

7.2 Asetukset: Kellotoiminnot

Asetukset: Kellonaika

 - vilkkuu, kun uuni kytketään sähköverkkoon, sähkökatkon jälkeen tai kun ajastinta ei ole asetettu.

 ,  - paina asettaaksesi kellonajan.

Vilkuminen lakkaa noin 5 sekunnin kuluttua ja näytössä näkyy kellonaika.

Ajan muuttaminen: Kellonaika

1. vaihe  - paina toistuvasti kellonajan muuttamiseksi.  - alkaa vilkkuu.



2. vaihe  ,  - paina asettaaksesi kellonajan.

Vilkuminen lakkaa noin 5 sekunnin kuluttua ja näytössä näkyy kellonaika.

Asetukset: Kesto

1. vaihe Aseta uunitoiminto ja uunin lämpötila.

2. vaihe  - paina toistuvasti.  - alkaa vilkkuu.

3. vaihe  ,  - aseta kesto painamalla.

Näytössä näkyy: 

 - vilkkuu asetetun ajan päättyessä. Äänimerkki kuuluu ja uuni kytkeytyy pois päältä.

4. vaihe Voit sammuttaa äänimerkin painamalla mitä tahansa painiketta.

5. vaihe Käännä säätimet Off (pois päältä) -asentoon.



Asetukset: Hälytinajastin

1. vaihe  - paina toistuvasti.  - alkaa vilkkuu.

Asetukset: Hälytinajastin

- 2. vaihe**  - paina asettaaksesi kellonajan.
Toiminto käynnistyy automaattisesti 5 sekunnin kuluttua.
Laitteesta kuuluu äänimerkki, kun asetettu aika on päättynyt.
- 3. vaihe** Voit sammuttaa äänimerkin painamalla mitä tahansa painiketta.
- 4. vaihe** Käännä säätimet Off (pois päältä) -asentoon.

Peruuttaminen: Kellotoiminnot

- 1. vaihe**  - paina toistuvasti, kunnes kellotoiminnon symboli alkaa vilkkua.
- 2. vaihe** Paina ja pidä painettuna painiketta: :
Kellotoiminto sammuu muutaman sekunnin kuluttua.

8. LISÄVARUSTEIDEN KÄYTTÄMINEN

VAROITUS!

Lue turvallisuutta koskevat luvut.

8.1 Lisävarusteiden asennus

Pieni lovi yläosassa parantaa turvallisuutta.
Nämä lovet toimivat myös kaatumisen

estämisessä. Ritilän korkea reunus estää keittoastioiden luisumisen hyllyltä.

Paistoritilä:

Paina ritilä liukukiskoja väliin kannatinkiskoon .

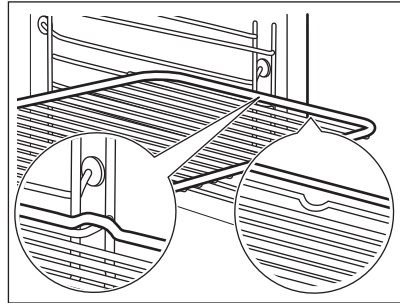

Leivinpelti / Syvä pannu:

Työnnä leivinpelti hyllykannattimen ohjauskiskojen väliin.

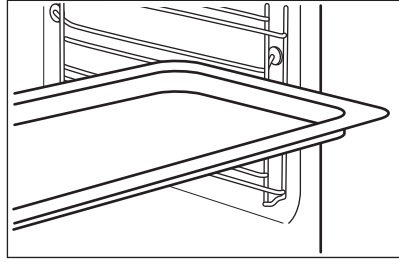

9. LISÄTOIMINNOT

9.1 Jäähdytyspuhallin

Kun laite on päällä, jäähdytyspuhallin kytkeytyy automaattisesti päälle pitääkseen

laitteen pinnat viileinä. Kun kytket laitteen pois päältä, jäähdytyspuhallin on käynnissä, kunnes laite on jäähtynyt.

10. VIHJEITÄ JA NEUVOJA



Lue turvallisuutta koskevat luvut.

10.1 Ruoanlaittoon liittyviä suosituksia



Taulukoissa mainitut lämpötilat ja paistoajat ovat ainoastaan suuntaa-antavia. Optimaalinen aika ja lämpötila riippuvat reseptistä ja käytettyjen ainesten laadusta ja määrästä.

Laitteesi voi paistaa eri tavalla kuin entinen laitteesi. Alla olevat vinkit sisältävät suositellut lämpötilat, kypsennyssajat ja kannatintasot eri ruokalajeille.

Jos taulukosta ei löydy reseptiisi sopivia asetuksia, voit soveltaa jonkin samantyyppisen paistoksen asetuksia.

10.2 Paistaminen

Käytä alhaisempaa lämpötilaa ensimmäisellä paistokerralla.

Jos paistat useammalla kuin yhdellä kannatintasolla, voit pidentää paistoaikaa 10 – 15 minuuttia.

Eri kannatintasoilla olevat leivonnaiset voivat ruskistua epätasaisesti. Lämpötila-asetusta ei





tarvitse muuttaa, jos ruskistuminen on epätasaista. Erot tasaantuvat paistumisen jatkuessa.

Uunissa olevat pellit voivat vääntyä paistamisen aikana. Jäähtyessään uunipellit palautuvat kuitenkin alkuperäiseen muotoonsa.

10.3 Leivontavinkkejä

Leivontatulos	Mahdollinen syy	Korjaustoimenpide
Kakun pohja ei ole riittävän kypsä.	Kannatintaso on virheellinen.	Laita kakku alemmalle kannatintasolle.
Kakku laskeutuu, se on taikimainen tai liian kostea.	Uunin lämpötila on liian korkea.	Käytä seuraavalla kerralla hiukan alhaisempaa lämpötilaa.
	Liian korkea paistolämpötila ja liian lyhyt paistoaika.	Aseta seuraavalla kerralla pitempi paistoaika ja alhaisempi lämpötila.
Kakku on liian kuiva.	Uunin lämpötila on liian matala.	Käytä seuraavalla kerralla hiukan korkeampaa lämpötilaa.
	Liian pitkä paistoaika.	Aseta seuraavalla kerralla lyhyempi paistoaika.
Kakku kypsyy epätasaisesti.	Liian korkea paistolämpötila ja liian lyhyt paistoaika.	Aseta seuraavalla kerralla pitempi paistoaika ja alhaisempi lämpötila.
	Kakkutaikina ei ole jakautunut tasaisesti.	Levitä kakkutaikina seuraavalla kerralla tasaisesti leivinpeltiin.
Kakku ei paistu reseptissä ilmoitetussa paistojassassa.	Uunin lämpötila on liian matala.	Käytä seuraavalla kerralla hiukan korkeampaa lämpötilaa.



10.4 Paistaminen yhdellä kannatintasolla

 VUOASSA PAISTETUT LEIVONNAISET		 (°C)	 (min)	
Kakkupohja murotaikinasta, esikuumenna tyhjä uuni	Kuumennettu kiertoilma	170 - 180	10 - 25	2
Torttupohja vatkatusta taikinasta	Kuumennettu kiertoilma	150 - 170	20 - 25	2
Maustekakku / Briossi	Kuumennettu kiertoilma	150 - 160	50 - 70	1
Maustekakku / Hedelmäkotelo	Kuumennettu kiertoilma	140 - 160	70 - 90	1
Juustokakku	Ylä-/alalämpö	170 - 190	60 - 90	1

Käytä kolmatta kannatintasoa.

Valitse toiminto: Kuumennettu kiertoilma.





Käytä leivinpeltiä.

 KAKUT / LEIVONNAISET / LEIVÄT	 (°C)	 (min)
Strösselikkaku	150 - 160	20 - 40
Marja-/hedelmäpiirakka (hiivataikina / vatkattu taikina), käytä uunipannua	150	35 - 55
Marja-/hedelmäpiirakka, murotaikinapohja	160 - 170	40 - 80





Esikuumenna tyhjää uunia.





Valitse toiminto: Ylä-/alalämpö.

Käytä leivinpeltiä.

 KAKUT / LEIVONNAISET / LEIVÄT	 (°C)	 (min)	
Kääretorttu	180 - 200	10 - 20	3
Ruisleipä:	ensin: 230 myöhemmin: 160 - 180	20 30 - 60	1
Voilla leivottu mantelikkaku / Sokerikkakut	190 - 210	20 - 30	3
Tuulihatut / Eclair-leivokset	190 - 210	20 - 35	3
Pullapitko / Pullakranssi	170 - 190	30 - 40	3
Marja-/hedelmäpiirakka (hiivataikina / vatkattu taikina), käytä uunipannua	170	35 - 55	3
Pellillä paistetut leivonnaiset, arkalaatuinen täyte (esim. rahka, kerma, vanukas)	160 - 180	40 - 80	3
Joulupulla (stollen)	160 - 180	50 - 70	2





Käytä kolmatta kannatintasoa.

 PIKKULEIVÄT		 (°C)	 (min)
Murotaikinapikkuleivät	Kuumennettu kiertoilma	150 - 160	10 - 20
Sämpylät, esikuumenna tyhjä uuni	Kuumennettu kiertoilma	160	10 - 25
Pikkuleivät vatkatusta taikina-	Kuumennettu kiertoilma	150 - 160	15 - 20

 PIKKULEIVÄT		 (°C)	 (min)
Lehtitaiquina, esikuumenna tyhjä uuni	Kuumennettu kiertoilma	170 - 180	20 - 30
Pikkuleivät hiivataikinasta	Kuumennettu kiertoilma	150 - 160	20 - 40
Macaron leivos	Kuumennettu kiertoilma	100 - 120	30 - 50
Munanvalkuaisleivonnaiset / Marengit	Kuumennettu kiertoilma	80 - 100	120 - 150
Sämpylät, esikuumenna tyhjä uuni	Ylä-/alalämpö	190 - 210	10 - 25

10.5 Paistokset ja gratiinit





Käytä ensimmäistä kannatintasoa.





		 (°C)	 (min)
Juustokorutitset patongit	Kuumennettu kiertoilma	160 - 170	15 - 30
Vihannesgratiini, esikuumentena tyhjä uuni	Tehogrillaus	160 - 170	15 - 30
Lasagne	Ylä-/alalämpö	180 - 200	25 - 40
Kalalaatikko	Ylä-/alalämpö	180 - 200	30 - 60
Täytetyt vihannekset	Kuumennettu kiertoilma	160 - 170	30 - 60
Makeat kohokkaat	Ylä-/alalämpö	180 - 200	40 - 60
Makaronilaatikko	Ylä-/alalämpö	180 - 200	45 - 60

10.6 Paistaminen useilla kannatintasoilla

Valitse toiminto: Kuumennettu kiertoilma.

Käytä leivinpeltiä.

 KAKKU/ PIIRAKKA	 (°C)	 (min)	 2 tasoa
Tuulihatut / Eclair-leivokset, esikuumenna tyhjä uuni	160 - 180	25 - 45	1 / 4
Kuiva streusel-kakku	150 - 160	30 - 45	1 / 4

 PIKKU-LEIVÄT / PIENET KAKUT / LEIVONNAISET / SÄMPYLÄT	 (°C)	 (min)		
			2 tasoa	3 tasoa
Sämpylät	180	20 - 30	1 / 4	-
Murotaikinapikkuleivät	150 - 160	20 - 40	1 / 4	1 / 3 / 5
Pikkuleivät vatkatusta taikinasta	160 - 170	25 - 40	1 / 4	-
Lehtitaiquina, esikuumenna tyhjä uuni	170 - 180	30 - 50	1 / 4	-
Pikkuleivät hiivataikinasta	160 - 170	30 - 60	1 / 4	-
Macaron leivos	100 - 120	40 - 80	1 / 4	-
Munanvalkuaisleivonnaiset / Marengit	80 - 100	130 - 170	1 / 4	-

10.7 Vinkkejä paistamiseen

Käytä lämmönkestäviä uunivuokia.

Paista vähärasvaista lihaa peitettynä (voit käyttää alumiinifoliota).

Paista suuret lihapalat suoraan leivinpellillä.

Kaada hiukan nestettä paistoastiaan, jotta valuva rasva ei pala.

Käännä paistia, kun paistoajasta on kulunut 1/2 - 2/3.





Paista liha tai kala suurina (vähintään 1 kg:n) palasina.

Jos käytettäväksi suositellaan tasoa ensimmäistä tasoa, aseta ruoka suoraan leivinpellille.

Valele paistien päälle niistä tulevia nesteitä useita kertoja paistamisen aikana.

10.8 Lihan paistaminen

Käytä ensimmäistä kannatintasoa.

 NAUDANLIHA				
			(°C)	(min)
Patapaisti	1 - 1,5 kg	Ylä-/alalämpö	230	120 - 150
Paahtopaisti tai filee, puolikypsä, esikuumenna tyhjä uuni	per paksuus/cm	Tehogrillaus	190 - 200	5 - 6
Paahtopaisti tai filee: puolikypsä, esikuumenna tyhjä uuni	per paksuus/cm	Tehogrillaus	180 - 190	6 - 8



NAUDANLIHA



(°C)



(min)

Paahtopaisti tai filee:
 kypsä, esikuumenna tyh-
 jä uuni

per paksuus/cm

Tehogrillaus

170 - 180

8 - 10



PORSAANLIHA



Valitse toiminto: Tehogrillaus.



(kg)



(°C)



(min)

Lapa / Niska / Kinkku

1 - 1,5

160 - 180

90 - 120

Kyljykset / Siankylki

1 - 1,5

170 - 180

60 - 90

Lihamureke

0,75 - 1

160 - 170

50 - 60

Porsaan potka, esikypsennetty

0,75 - 1

150 - 170

90 - 120



VASIKANLIHA



Valitse toiminto: Tehogrillaus.



(kg)



(°C)



(min)

Vasikanpaisti

1

160 - 180

90 - 120

Vasikanpotka

1,5 - 2

160 - 180

120 - 150



LAMMAS



Valitse toiminto: Tehogrillaus.



(kg)



(°C)



(min)

Lampaanreisi / Lammaspaisti

1 - 1,5

150 - 170

100 - 120

Lampaansatula

1 - 1,5

160 - 180

40 - 60



RIISTA



Valitse toiminto: Ylä-/alalämpö.



(kg)



(°C)



(min)

Selkä / Jäniksenkoipi, esikuumenna tyhjä uuni

korkeintaan 1

230

30 - 40

Kauriin-/hirsensatula

1,5 - 2

210 - 220

35 - 40

Kauriin-/hirvenreisi

1,5 - 2

180 - 200

60 - 90



LINTUPAISTI



Valitse toiminto: Tehogrillaus.



(kg)



(°C)



(min)

Linnunliha, paloina

0,2 - 0,25 kpl

200 - 220

30 - 50

Kana, puolikas

0,4 - 0,5 kpl

190 - 210

35 - 50

Broileri, kana

1 - 1,5

190 - 210

50 - 70

Ankka

1,5 - 2

180 - 200

80 - 100

Hanhi

3,5 - 5

160 - 180

120 - 180

Kalkkuna

2,5 - 3,5

160 - 180

120 - 150

Kalkkuna

4 - 6

140 - 160

150 - 240



KALA (HAUDUTETTU)



Valitse toiminto: Ylä-/alalämpö.



(kg)



(°C)



(min)

Kokonainen kala

1 - 1,5

210 - 220

40 - 60

10.9 Rapea pinta: Pizza-toiminto



PIZZA



Käytä ensimmäistä kannatintasoa.



(°C)



(min)

Tortut

180 - 200 40 - 55

Pinaattipiiras

160 - 180 45 - 60

Kinkkupiiras / Sveitsiläinen piiras

170 - 190 45 - 55

Juustokakku

140 - 160 60 - 90

Vihannespiiras

160 - 180 50 - 60



PIZZA



Esikuumenna tyhjää uunia ennen ruokien asettamista uuniin.



Käytä toista kannatintasoa.



(°C)



(min)

Pizza, ohut pohja, käytä uuni-
pannua

200 - 230

15 - 20



PIZZA



Esikuumenna tyhjää uunia ennen ruokien asettamista uuniin.



Käytä toista kannatintasoa.



(°C)



(min)

Pizza, paksu
pohja

180 - 200

20 - 30

Kohottamaton
leipä

230 - 250

10 - 20

Voitaikinapohjai-
nen piiras

160 - 180

45 - 55

Flammkuchen

230 - 250

12 - 20

Pierogi

180 - 200

15 - 25

10.10 Grilli

Esikuumenna tyhjää uunia ennen ruokien asettamista uuniin.

Grillaa vain ohuita liha- tai kalapaloja.

Aseta pannu ensimmäiselle kannatintasolle rasvan keräämiseksi.



GRILLI



Valitse toiminto: Grilli



(°C)



(min)
1. puoli



(min)
2. puoli



	(°C)	(min) 1. puoli	(min) 2. puoli	
Paahtopaisti	210 - 230	30 - 40	30 - 40	2
Naudanfilee	230	20 - 30	20 - 30	3
Porsaankylkipaisti	210 - 230	30 - 40	30 - 40	2
Vasikankylkipaisti	210 - 230	30 - 40	30 - 40	2
Lampaansatula	210 - 230	25 - 35	20 - 25	3
Kokonainen kala, 0,5 kg - 1 kg	210 - 230	15 - 30	15 - 30	3 / 4

10.11 Pakasteet



Sulatus



Valitse toiminto: Kuumennettu kiertoilma.



(°C)



(min)



	(°C)	(min)	
Pizza, pakaste	200 - 220	15 - 25	2
Pizza American, pakaste	190 - 210	20 - 25	2
Pizza, kylmä	210 - 230	13 - 25	2
Pizzapalat, pakaste	180 - 200	15 - 30	2
Ranskalaiset perunat, ohuet	200 - 220	20 - 30	3
Ranskalaiset perunat, paksut	200 - 220	25 - 35	3
Lohkoperunat / Krokettit	220 - 230	20 - 35	3
Röstiperunat	210 - 230	20 - 30	3
Lasagne / Cannelloni, tuore	170 - 190	35 - 45	2
Lasagne / Cannelloni, pakaste	160 - 180	40 - 60	2
Uunijuusto	170 - 190	20 - 30	3
Kanan siipipalat	190 - 210	20 - 30	2





10.12 Sulatus

Poista pakkausmateriaalit ja aseta ruoka lautaselle.

Älä peitä ruokaa, muutoin sulatusaika voi olla pitempi.

Käytä ensimmäistä kannatintaso.

Kun ruoka on suurikokoinen, aseta tyhjä lautanen ylösalaisin uunin pohjalle. Aseta ruoka syvään astiaan ja aseta se uunin sisällä olevan lautasan päälle. Poista tarvittaessa kannattimet.

	 (kg)	 (min) Sulatusaika	 (min) Jälkisolatusaika	
Kana	1	100 - 140	20 - 30	Käännä kypsennyksen puolivälissä.
Liha	1	100 - 140	20 - 30	Käännä kypsennyksen puolivälissä.
Taimen	0,15	25 - 35	10 - 15	-
Mansikat	0,3	30 - 40	10 - 20	-
Voi	0,25	30 - 40	10 - 15	-
Kerma	2 x 0,2	80 - 100	10 - 15	Vatkaa kerma, kun se on edelleen hiukan jäässä.
Täytekakku	1,4	60	60	-

10.13 Säilöntä

Valitse toiminto Alalämpö.

Käytä ainoastaan samankokoisia kaupoista saatavilla olevia säilöntäpurkkeja.

Älä käytä kierrekorkillisia ja pikalukittavia lasipurkkeja tai metallitölkkejä.

Käytä ensimmäistä kannatintaso.

Aseta leivinpellille korkeintaan kuusi yhden litran säilöntäpurkkia.





Täytä purkit tasaisesti ja sulje tiiviisti.



Purkit eivät saa koskettaa toisiaan.

Kaada noin 1/2 litraa vettä leivinpellille, jotta uunissa on riittävästi kosteutta.

Kun neste alkaa kiehua kevyesti ensimmäisissä purkeissa (litran purkissa noin 35 - 60 minuutin kuluttua), katkaise virta uunista tai alenna lämpötila 100 °C:seen (katso taulukko).

Aseta lämpötila 160 - 170 °C.

 PEHMEÄT MARJAT/HEDELMÄT	 (min) Keittoaika kiehumiseen	
Mansikat / Mustikat / Vadelmat / Kypsät karviaiset	35 - 45	
 LUUHE- DELMÄT	 (min) Keittoaika kiehumiseen	 (min) Jatka keittämistä 100 °C:ssa
Persikat / Kvitteinit / Luumut	35 - 45	10 - 15

 VI-HANNEKSET	 (min) Keittoaika kiehumiseen	 (min) Jatka keittä- mistä 100 °C:ssa
Porkkanat	50 - 60	5 - 10
Kurkut	50 - 60	-
Pikkelsi	50 - 60	5 - 10
Kyssäkaali / Her- neet / Parsa	50 - 60	15 - 20

10.14 Kuivaus - Kuumennettu kiertoilma

Peitä pellit leivinpaperilla.

Saat paremman lopputuloksen, kun pysäytät uunin sen saavutettua kuivausajan puolivälin, avaat uunin luukun, ja annat sen jäähtyä ja kuivua yön yli.

Käytä yhden leivinpellin tapauksessa kolmatta hyllykannatintasoa.

Käytä kahden leivinpellin tapauksessa ensimmäistä ja neljättä hyllykannatintasoa.

10.15 Kosteaa kiertoilma – suositellut varusteet

Käytä tummia heijastamattomia vuokia ja astioita. Ne absorboivat enemmän lämpöä vaaleisiin ja heijastaviin astioihin verrattuna.



Pizzapannu

Tumma, heijastamaton
28 cm halkaisija



Uunivuoka

Tumma, heijastamaton
26 cm halkaisija



Annosvuokat

Keramiikka
halkaisija 8 cm,
korkeus 5 cm

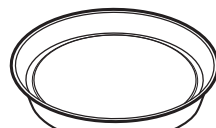



Torttuvuoka



Tumma, heijastamaton
28 cm halkaisija





10.16 Kosteaa kiertoilma

Noudata alla olevan taulukon ehdotuksia parhaan tuloksen saavuttamiseksi.

 VIHANNEK- SET	 (°C)	 (tuntia)
Pavut	60–70	6–8
Paprika	60–70	5–6
Keittovihannekset	60–70	5–6
Sienet	50–60	6–8
Yrtit	40–50	2–3

Aseta lämpötilaksi 60–70 °C.





 HEDELMÄT	 (tuntia)
Luumut	8–10
Aprikoosit	8–10
Omenaviipaleet	6–8
Päärynät	6–9

	 (°C)	 (min)	
Leipätikut, yhteensä 0,5 kg	190 - 200	50 - 60	3
Paistetut kampsimpukat kuorissa	180 - 200	30 - 40	4
Kokonainen kala suolakuoressa, 0,3 - 0,5 kg	190 - 200	45 - 50	4
Kokonainen kala leivinpaperilla peitettynä, 0,3 - 0,5 kg	190 - 200	50 - 60	3
Amaretti-keksit (20; yhteensä 0,5 kg)	170 - 180	40 - 50	3
Omenahyve	190 - 200	50 - 60	4
Suklaamuffinit (20; yhteensä 0,5 kg)	160 - 170	35 - 45	3

10.17 Tiedoksi testauslaitoksille





Testit seuraavan mukaisesti: EN 60350, IEC 60350.

Paistaminen yhdellä tasolla – vuoassa





		 °C	 min	
Rasvaton sokerikakku	Kuumennettu kiertoilma	160	45 - 60	2
Rasvaton sokerikakku	Ylä-/alalämpö	160	45 - 60	2
Omenapiirakka, 2 vuokaa Ø20 cm	Kuumennettu kiertoilma	160	55 - 65	2
Omenapiirakka, 2 vuokaa Ø20 cm	Ylä-/alalämpö	180	55 - 65	1
Murokeksit	Kuumennettu kiertoilma	140	25 - 35	2
Murokeksit	Ylä-/alalämpö	140	25 - 35	2

Paistaminen yhdellä tasolla – pikkuleivät

Käytä kolmatta hyllytasoa.

		 °C	 min
Pienet kakut (20 kpl/leivinpelti), esikuumenna tyhjä uuni	Kuumennettu kiertoilma	150	20 - 30
Pienet kakut (20 kpl/leivinpelti), esikuumenna tyhjä uuni	Ylä-/alalämpö	170	20 - 30





Paistaminen usealla tasolla – pikkuleivät

		 °C	 min	
Murokeksit	Kuumennettu kiertoilma	140	25 - 45	2 / 4
Pienet kakut (20 kpl/leivinpelti), esikuumenna tyhjä uuni	Kuumennettu kiertoilma	150	25 - 35	1 / 4
Rasvaton sokerikakku	Kuumennettu kiertoilma	160	45 - 55	2 / 4
Omenapiirakka, 1 vuoka ritilää kohden (Ø 20 cm)	Kuumennettu kiertoilma	160	55 - 65	2 / 4

Grilli

Esikuumenna tyhjä uunia 5 minuutin ajan.

Grillaa lämpötilan suurimmalla asetuksella.

		 min	
Paahtoleipä	Grilli	1 - 2	5
Naudanlihapihvi, käännä kypsennyksen puolivälissä	Grilli	24 - 30	4

11. HOITO JA PUHDISTUS

VAROITUS!

Lue turvallisuutta koskevat luvut.

11.1 Puhdistukseen liittyviä huomautuksia



Puhdistusaineet

Puhdista laitteen etuosa pelkällä lämpimällä vedellä ja miedolla pesuaineella mikrokituliinaa käyttäen.

Puhdista metallipinnat puhdistusaineella.

Poista tahrat miedolla pesuaineella.



Jokapäiväinen käyttö

Puhdista uunin sisäosa jokaisen käytön jälkeen. Rasvan tai muiden jäämien kertyminen saattaa aiheuttaa tulipalon.

Älä jätä ruokia laitteeseen 20 minuuttia pidemmäksi ajaksi. Kuivaa sisäosa pelkällä mikrokituliinalla jokaisen käyttökerran jälkeen.



Tarvikkeet

Puhdista kaikki varusteet jokaisen käytön jälkeen ja anna niiden kuivua. Käytä pelkästään mikrokuituliinaa, lämmintä vettä ja mietoä puhdistusainetta. Varusteita ei saa pestä astianpesukoneessa.

Tarttumattomia lisävarusteita ei saa puhdistaa hankaavilla puhdistusaineilla tai teräväreunaisilla esineillä.

11.2 Irrottaminen: Kannattimet

Poista kannattimet uunin puhdistamiseksi.

- 1. vaihe** Kytke uuni pois päältä ja odota, että se jäähtyy.
- 2. vaihe** Vedä uunipeltien kannattimen etuosa irti sivuseinästä.
- 3. vaihe** Vedä uunipeltien kannatinkiskon takaosa irti sivuseinästä ja poista se.
- 4. vaihe** Asenna hyllytuet päinvastaisessa järjestyksessä.

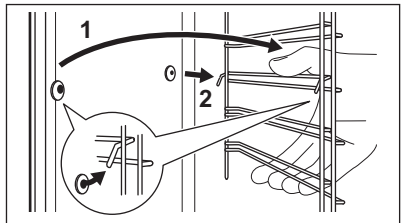
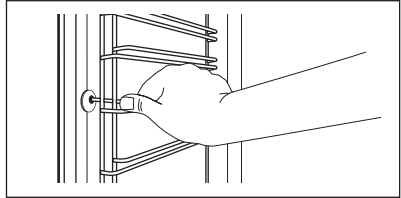

11.3 Irrottaminen: Grilli

VAROITUS!

Olemassa on palovammojen vaara.

- 1. vaihe** Kytke uuni pois toiminnasta ja puhdista se vasta sitten, kun se on jäähtynyt. Irrota ritilöiden kannattimet.
- 2. vaihe** Tartu grillin nurkkiin. Vedä sitä eteenpäin jousipainetta vastaan ja ulospäin molemmasta pidikkeestä. Grilli taittuu alaspäin.
- 3. vaihe** Puhdista uunin katto lämpimällä vedellä, pehmeällä liinalla ja miedolla pesuaineella. Anna sen kuivua.
- 4. vaihe** Asenna grilli noudattamalla ohjeita päinvastaisessa järjestyksessä.
- 5. vaihe** Asenna ritilöiden kannattimet.

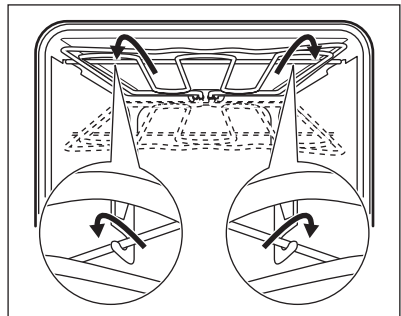

11.4 Irrottaminen ja asentaminen: Luukku

Voit poistaa luukun ja sisäiset lasilevyt niiden puhdistamiseksi. Lasipaneelin lukumäärä vaihtelee eri malleissa.

⚠ VAROITUS!

Luukku on painava.

⚠ HUOMIO!

Käsittele lasia varoen, tämä koskee erityisesti etupaneelin reunoja. Lasi voi rikkoontua.

- 1. vaihe** Avaa luukku kokonaan.
- 2. vaihe** Paina ja nosta saranoissa olevat lukitusvivut (A).

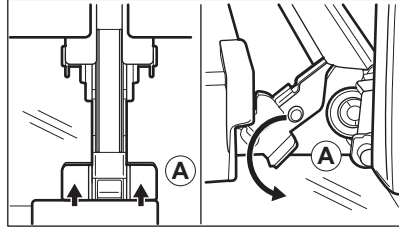

- 3. vaihe** Sulje uunin luukku ensimmäiseen avausasentoon (likimäärin 70° kulma). Tartu luukkuun kummaltakin puolelta ja vedä se irti uunista ylöspäin suuntautuvassa kulmassa. Aseta luukku sen ulkopinta alaspäin vakaalle pinnalle levitetyn liinan päälle.

- 4. vaihe** Pidä kiinni luukun reunalistasta (B) molemmin puolin luukun yläreunaa ja työnnä sisäänpäin vapauttaaksesi pinnetiivisteet.

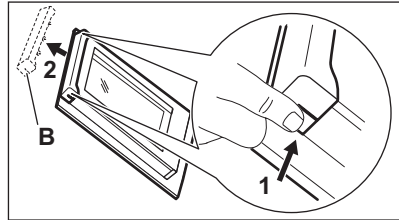

- 5. vaihe** Irrota luukun reunalista vetämällä sitä eteenpäin.
- 6. vaihe** Tartu lasilevyihin yläreunasta ja vedä ne yksi kerrallaan ulos kiskoista.

- 7. vaihe** Puhdista lasipaneeli vedellä ja saippualla. Kuivaa lasipaneeli huolellisesti. Lasilevyjä ei saa pestä astianpesukoneessa.

- 8. vaihe** Suorita edellä kuvatut vaiheet päinvastaisessa järjestyksessä puhdistamisen jälkeen.

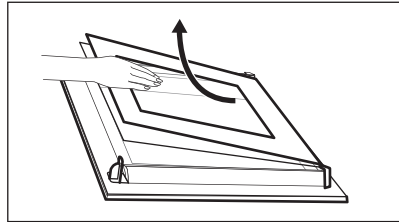

- 9. vaihe** Kiinnitä ensiksi pienin lasilevy, sitten suurempi ja lopuksi luukku. Varmista, että lasit on asetettu oikeaan asentoon. Muutoin luukun pinta voi ylikuumentua.

11.5 Vaihdaminen: Lamppu

⚠ VAROITUS!

Sähköiskun vaara.
Lamppu voi olla kuuma.

Ennen lampun vaihtamista:

1. vaihe

Kytke uuni pois päältä. Odota, kunnes uuni on jäähtynyt.

2. vaihe

Irrota uunin pistoke pistorasiasta.

3. vaihe

Peitä uunin pohja kankaalla.

Ylälamppu

1. vaihe Irrota suojalasi kiertämällä sitä.

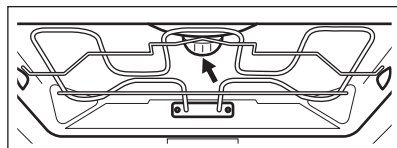

2. vaihe Puhdista lampun kansi.

3. vaihe Vaihda lamppu sopivaan 300 °C lämmönkestävään lamppuun.

4. vaihe Asenna lasinen kansi.

12. VIANMÄÄRITYS

VAROITUS!

Lue turvallisuutta koskevat luvut.

12.1 Käyttöhäiriöt...

Mikäli laitteessa ilmenevää ongelmaa ei ole kuvattu tässä taulukossa, ota yhteyttä valtuutettuun huoltoliikkeeseen.

12.2 Huoltotiedot

Jos et itse löydä ratkaisua ongelmaasi, ota yhteys jälleenmyyjään tai valtuutettuun huoltopalveluun.

Huoltoliikkeen tarvitsemat perustiedot löydät laitteen arvokilvestä. Arvokilpi löytyy laitteen sisätilan etukehyksestä. Älä poista arvokilpeä laitteen sisätilasta.

Suosittellemme, että kirjoita tiedot tähän:

Malli (Mod.):

Tuotenumero (PNC)

Sarjanumero (S.N.)

Ongelma

Tarkista, jos...

Uuni ei kuumene.

Sulake on palanut.

Näytössä näkyy "12.00".

On tapahtunut virtakatko.
Aseta kellonaika.

Lamppu ei toimi.

Lamppu on palanut.

13. ENERGIATEHOKKUUS

13.1 EU:n ekologisen suunnittelun ja energiamerkintätuotetiedot ja tuotetietolomake

Toimittajan nimi	AEG	
Mallin tunniste	BEK435060B 944188455 EB40B 944188534	
Energiatehokkuusluokka	81,2	
Energiatehokkuusluokka	A+	
Energiankulutus normaalikäytössä Ylä- ja alalämpö -toiminnossa	0,99kWh/kierros	
Energiankulutus vakiokuormalla, tuuletintila	0,69kWh/kierros	
Pesien lukumäärä	1	
Lämpölähde	Sähkö	
Äänimer.voimak	71l	
Uunityyppi	Kalusteeseen asennettava uuni	
Massa	BEK435060B	33.0kg
	EB40B	33.0kg

IEC/EN 60350-1 – Ruoanlaittoon tarkoitetut sähkötoimiset kodinkoneet – Osa 1: Mallistot, uunit, höyryuunit ja grillit – Menetelmiä tehon mittaukseen.

13.2 Energiansäästö



Laitteessa on joitakin toimintoja, joiden avulla voit säästää energiaa.

Varmista, että laitteen luukku on kiinni laitteen ollessa käynnissä. Älä avaa laitteen luukkua liian usein kypsennyksen aikana. Pidä luukun tiiviste puhtaana ja varmista, että se on hyvin kiinni paikoillaan.

Käytä metallisia keittoastioita energiatehokkuuden parantamiseksi.

Jos vain mahdollista, älä esikuumenna laitetta ennen ruokien asettamista uuniin.

Minimoi paistojen väliset tauot, kun valmistat kerralla useampia ruokia.

Puhallintoiminnon käyttäminen ruoanlaiton yhteydessä

Jos mahdollista, käytä uunitoimintoja puhaltimella energian säästämiseksi.

Jäännöslämpö

Kun kypsennys kestää yli 30 minuuttia, laske laitteen lämpötila alimmalle asetukselle 3–10 minuuttia ennen kypsennysajan päättymistä. Jälkilämpö laitteen sisällä jatkaa ruoka-aineksien kypsentämistä.

Lämmitä muita ruokalajeja jälkilämpöä käyttäen.

Ruoan lämpimänä pitoon

Valitse alhaisin mahdollisin lämpötila-asetus, niin voit hyödyntää jälkilämmön ja säilyttää aterian lämpimänä.

Kostea kiertoilma

Tämä toiminto säästää energiaa ruoanlaiton aikana.

14. YMPÄRISTÖNSUOJELU

Kierrätä materiaalit, jotka on merkitty merkillä

 Kierrätä pakkaus laittamalla se asianmukaiseen kierrätysastiaan. Suojele ympäristöä ja ihmisten terveyttä kierrättämällä sähkö- ja elektroniikkaromut.

Älä hävitä merkillä  merkittyjä kodinkoneita kotitalousjätteen mukana. Palauta tuote paikalliseen kierrätyskeskukseen tai ota yhteyttä paikalliseen viranomaiseen.

POUR DES RÉSULTATS PARFAITS

Merci d'avoir choisi ce produit AEG. Nous l'avons conçu pour qu'il vous offre des performances irréprochables pendant de nombreuses années, en intégrant des technologies innovantes vous simplifiant la vie – fonctions que vous ne trouverez peut-être pas sur des appareils ordinaires. Veuillez prendre quelques instants pour lire cette notice afin d'utiliser au mieux votre appareil.

Consultez notre site pour :



Obtenir des conseils d'utilisation, des brochures, un dépanneur, des informations sur le service et les réparations :

www.aeg.com/support



Enregistrer votre produit pour un meilleur service :

www.registreaeg.com



Acheter des accessoires, consommables et pièces de rechange d'origine pour votre appareil :

www.aeg.com/shop

SERVICE ET ASSISTANCE À LA CLIENTÈLE

N'utilisez que des pièces de rechange d'origine.

Avant de contacter notre centre de service agréé, assurez-vous de disposer des informations suivantes : Modèle, PNC, numéro de série.

Ces informations figurent sur la plaque signalétique.

 Avertissement/Consignes de sécurité

 Informations générales et conseils

 Informations environnementales

Sous réserve de modifications.

TABLE DES MATIÈRES

1. INFORMATION SUR LA SÉCURITÉ.....	115
2. CONSIGNES DE SÉCURITÉ.....	117
3. DESCRIPTION DE L'APPAREIL.....	120
4. BANDEAU DE COMMANDE.....	121
5. AVANT LA PREMIÈRE UTILISATION.....	121
6. UTILISATION QUOTIDIENNE.....	122
7. FONCTIONS DE L'HORLOGE.....	123
8. UTILISATION DES ACCESSOIRES.....	124
9. FONCTIONS SUPPLÉMENTAIRES.....	125
10. CONSEILS ET ASTUCES.....	125
11. ENTRETIEN ET NETTOYAGE.....	138
12. DÉPANNAGE.....	141
13. RENDEMENT ÉNERGÉTIQUE.....	142
14. EN MATIÈRE DE PROTECTION DE L'ENVIRONNEMENT.....	143

1. ⚠ INFORMATION SUR LA SÉCURITÉ

Avant d'installer et d'utiliser cet appareil, lisez soigneusement les instructions fournies. Le fabricant ne pourra être tenu pour responsable des blessures et dégâts résultant d'une mauvaise installation ou utilisation. Conservez toujours les instructions dans un lieu sûr et accessible pour vous y référer ultérieurement.

1.1 Sécurité des enfants et des personnes vulnérables

- Cet appareil peut être utilisé par des enfants âgés d'au moins 8 ans et par des personnes ayant des capacités physiques, sensorielles ou mentales réduites ou dénuées d'expérience ou de connaissance, s'ils sont correctement surveillés ou si des instructions relatives à l'utilisation de l'appareil en toute sécurité leur ont été données et s'ils comprennent les risques encourus. Les enfants de moins de 8 ans et les personnes ayant un handicap très important et complexe doivent être tenus à l'écart de l'appareil, à moins d'être surveillés en permanence.
- Veillez à ce que les enfants ne jouent pas avec l'appareil.
- Ne laissez pas les emballages à la portée des enfants et jetez-les convenablement.
- **AVERTISSEMENT** : L'appareil et ses parties accessibles deviennent chauds pendant l'utilisation. Tenez les enfants et les animaux éloignés de l'appareil lorsqu'il est en cours d'utilisation et de refroidissement.
- Si l'appareil est équipé d'un dispositif de sécurité enfants, nous vous recommandons de l'activer.
- Le nettoyage et l'entretien par l'utilisateur ne doivent pas être effectués par des enfants sans surveillance.

1.2 Sécurité générale

- Cet appareil est exclusivement destiné à un usage culinaire.

- Cet appareil est conçu pour un usage domestique unique, dans un environnement intérieur.
- Cet appareil peut être utilisé dans les bureaux, les chambres d'hôtel, les chambres d'hôtes, les maisons d'hôtes de ferme et d'autres hébergements similaires lorsque cette utilisation ne dépasse pas le niveau (moyen) de l'utilisation domestique.
- Cet appareil doit être installé et le câble remplacé uniquement par un professionnel qualifié.
- N'utilisez pas l'appareil avant de l'avoir installé dans la structure encastrée.
- Débranchez l'appareil de l'alimentation électrique avant toute opération d'entretien.
- Si le cordon d'alimentation est endommagé, il doit être remplacé par le fabricant, son service après-vente agréé ou toute personne disposant de qualifications similaires afin d'éviter tout danger électrique.
- **AVERTISSEMENT** : Assurez-vous que l'appareil est éteint avant de remplacer l'ampoule pour éviter tout risque d'électrocution.
- **AVERTISSEMENT** : L'appareil et ses parties accessibles deviennent chauds pendant l'utilisation. Des précautions doivent être prises pour éviter de toucher les éléments chauffants ou la surface de la cavité de l'appareil.
- Utilisez toujours des gants de cuisine pour retirer ou insérer des accessoires ou des plats allant au four.
- Pour retirer les supports de grille, tirez d'abord l'avant du support de grille, puis l'arrière à distance des parois latérales. Installez les supports de grille dans l'ordre inverse.
- N'utilisez pas de nettoyeur à vapeur pour nettoyer l'appareil.
- N'utilisez pas de produits abrasifs ni de racloirs pointus en métal pour nettoyer la porte en verre car ils peuvent rayer la surface, ce qui peut briser le verre.

2. CONSIGNES DE SÉCURITÉ

2.1 Installation

AVERTISSEMENT!

L'appareil doit être installé uniquement par un professionnel qualifié.

- Retirez l'intégralité de l'emballage.
- N'installez pas et ne branchez pas un appareil endommagé.
- Suivez scrupuleusement les instructions d'installation fournies avec l'appareil.
- Soyez toujours vigilants lorsque vous déplacez l'appareil car il est lourd. Utilisez toujours des gants de sécurité et des chaussures fermées.
- Ne tirez jamais l'appareil par la poignée.
- Installez l'appareil dans un lieu sûr et adapté répondant aux exigences d'installation.
- Respectez l'espacement minimal requis par rapport aux autres appareils et éléments.
- Avant de monter l'appareil, vérifiez si la porte de l'appareil s'ouvre sans retenue.
- L'appareil est équipé d'un système de refroidissement électrique. Il doit être utilisé avec l'alimentation électrique.
- L'unité intégrée doit répondre aux exigences de stabilité de la norme DIN 68930.

Hauteur minimale du meuble (Hauteur minimale du meuble sous le plan de travail)	578 (600) mm
---	--------------

Largeur du meuble	560 mm
-------------------	--------

Profondeur du meuble	550 (550) mm
----------------------	--------------

Hauteur de l'avant de l'appareil	594 mm
----------------------------------	--------

Hauteur de l'arrière de l'appareil	576 mm
------------------------------------	--------

Largeur de l'avant de l'appareil	595 mm
----------------------------------	--------

Largeur de l'arrière de l'appareil	559 mm
------------------------------------	--------

Profondeur de l'appareil	567 mm
--------------------------	--------

Profondeur d'encastrement de l'appareil	546 mm
---	--------

Profondeur avec porte ouverte	1027 mm
-------------------------------	---------

Dimensions minimales de l'ouverture de ventilation. Ouverture placée sur la partie inférieure de la face arrière	560x20 mm
--	-----------

Longueur du câble d'alimentation secteur. Le câble est placé dans le coin droit de la face arrière	1500 mm
--	---------

Vis de montage	4x25 mm
----------------	---------

2.2 Branchement électrique

AVERTISSEMENT!

Risque d'incendie ou d'électrocution.

- Tous les raccordements électriques doivent être effectués par un électricien qualifié.
- L'appareil doit être relié à la terre.
- Assurez-vous que les paramètres figurant sur la plaque signalétique correspondent aux données électriques nominale de l'alimentation secteur.
- Utilisez toujours une prise de courant de sécurité correctement installée.
- N'utilisez pas d'adaptateurs multiprise et de rallonges.
- Veillez à ne pas endommager la fiche secteur ni le câble d'alimentation. Le remplacement du câble d'alimentation de l'appareil doit être effectué par notre service après-vente agréé.
- Ne laissez pas les câbles d'alimentation entrer en contact ou s'approcher de la porte de l'appareil ou de la niche d'encastrement sous l'appareil, particulièrement lorsqu'il est en marche ou que la porte est chaude.
- La protection contre les chocs des parties sous tension et isolées doit être fixée de telle manière qu'elle ne puisse pas être enlevée sans outils.

- Ne branchez la fiche secteur dans la prise secteur qu'à la fin de l'installation. Assurez-vous que la prise secteur est accessible après l'installation.
- Si la prise secteur est détachée, ne branchez pas la fiche secteur.
- Ne tirez pas sur le câble secteur pour débrancher l'appareil. Tirez toujours sur la fiche de la prise secteur.
- N'utilisez que des systèmes d'isolation appropriés : des coupe-circuits, des fusibles (les fusibles à visser doivent être retirés du support), un disjoncteur différentiel et des contacteurs.
- L'installation électrique doit comporter un dispositif d'isolation qui vous permet de déconnecter l'appareil du secteur à tous les pôles. Le dispositif d'isolement doit avoir une largeur d'ouverture de contact de 3 mm minimum.
- Cet appareil est fourni avec une fiche électrique et un câble d'alimentation.

2.3 Utilisation

AVERTISSEMENT!

Risque de blessures, de brûlures, d'électrocution ou d'explosion.

- Ne modifiez pas les spécifications de cet appareil.
- Assurez-vous que les orifices d'aération ne sont pas obstrués.
- Ne laissez pas l'appareil sans surveillance durant son fonctionnement.
- Éteignez l'appareil après chaque utilisation.
- Soyez prudent lors de l'ouverture de la porte de l'appareil lorsque celui-ci fonctionne. De l'air chaud peut se dégager.
- N'utilisez pas l'appareil avec des mains mouillées ou en contact avec de l'eau.
- N'exercez pas de pression sur la porte ouverte.
- N'utilisez pas l'appareil comme plan de travail ou comme espace de rangement.
- Ouvrez la porte de l'appareil avec précaution. L'utilisation d'ingrédients avec de l'alcool peut provoquer un mélange d'alcool et d'air.

- Ne laissez pas des étincelles ou des flammes nues entrer en contact avec l'appareil lorsque vous ouvrez la porte.
- Ne placez pas de produits inflammables ou d'éléments imbibés de produits inflammables à l'intérieur, à proximité ou au-dessus de l'appareil.

AVERTISSEMENT!

Risque d'endommagement de l'appareil.

- Pour éviter tout endommagement ou décoloration de l'émail :
 - ne posez pas de plats allant au four ou d'autres objets directement dans le fond de l'appareil.
 - ne placez jamais de feuilles d'aluminium directement sur le fond de la cavité de l'appareil.
 - ne versez pas d'eau directement dans l'appareil chaud.
 - ne conservez pas de plats et de nourriture humides dans l'appareil après avoir terminé la cuisson.
 - Installez ou retirez les accessoires avec précautions.
- La décoloration de l'émail ou de l'acier inoxydable est sans effet sur les performances de l'appareil.
- Utilisez un plat à rôtir pour des gâteaux moelleux. Les jus de fruits provoquent des taches qui peuvent être permanentes.
- Cuisinez toujours avec la porte de l'appareil fermée.
- Si l'appareil est installé derrière la paroi d'un meuble (par ex. une porte), veuillez à ce que la porte ne soit jamais fermée lorsque l'appareil fonctionne. La chaleur et l'humidité peuvent s'accumuler derrière la porte fermée du meuble et provoquer d'importants dégâts sur l'appareil, votre logement ou le sol. Ne fermez pas la paroi du meuble tant que l'appareil n'a pas refroidi complètement.

2.4 Entretien et Nettoyage

AVERTISSEMENT!

Risque de blessure, d'incendie ou de dommages matériels sur l'appareil.

- Avant toute opération d'entretien, éteignez l'appareil et débranchez la fiche de la prise secteur.
- Vérifiez que l'appareil est froid. Les panneaux de verre risquent de se briser.
- Remplacez immédiatement les vitres de la porte si elles sont endommagées. Contactez le service après-vente agréé.
- Soyez prudent lorsque vous retirez la porte de l'appareil. La porte est lourde !
- Nettoyez régulièrement l'appareil afin de maintenir le revêtement en bon état.
- Nettoyez l'appareil avec un chiffon doux humide. Utilisez uniquement des produits de lavage neutres. N'utilisez pas de produits abrasifs, de tampons à récurer, de solvants ni d'objets métalliques.
- Si vous utilisez un spray pour four, suivez les consignes de sécurité figurant sur son emballage.

2.5 Éclairage interne

AVERTISSEMENT!

Risque d'électrocution !

- Concernant la/les lampe(s) à l'intérieur de ce produit et les lampes de rechange vendues séparément : Ces lampes sont conçues pour résister à des conditions physiques extrêmes dans les appareils électroménagers, telles que la température, les vibrations, l'humidité, ou

sont conçues pour signaler des informations sur le statut opérationnel de l'appareil. Elles ne sont pas destinées à être utilisées dans d'autres applications et ne conviennent pas à l'éclairage des pièces d'un logement.

- Ce produit contient une source lumineuse de classe d'efficacité énergétique G.
- Utilisez uniquement des ampoules ayant les mêmes spécifications.

2.6 Service

- Pour réparer l'appareil, contactez le service après-vente agréé.
- Utilisez uniquement des pièces de rechange d'origine.

2.7 Mise au rebut

AVERTISSEMENT!

Risque de blessure ou d'asphyxie.

- Contactez votre service municipal pour obtenir des informations sur la marche à suivre pour mettre l'appareil au rebut.
- Débranchez l'appareil de l'alimentation électrique.
- Coupez le câble d'alimentation au ras de l'appareil et mettez-le au rebut.
- Retirez le dispositif de verrouillage du hublot pour empêcher les jeunes et les animaux de s'enfermer dans l'appareil.

3. DESCRIPTION DE L'APPAREIL

3.1 Vue d'ensemble

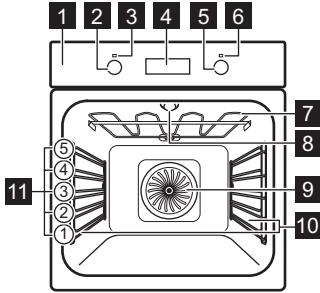

- 1 Bandeau de commande
- 2 Manette de sélection des modes de cuisson
- 3 Voyant / symbole de mise sous tension
- 4 Affichage
- 5 Manette de commande (de la température)
- 6 Indicateur / symbole de température
- 7 Élément chauffant
- 8 Éclairage
- 9 Chaleur tournante
- 10 Support de grille, amovible
- 11 Niveaux de la grille

3.2 Accessoires

Grille métallique

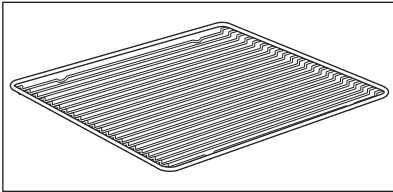

Pour les plats de cuisson, les moules à gâteaux, les rôtis.

Plateau de cuisson

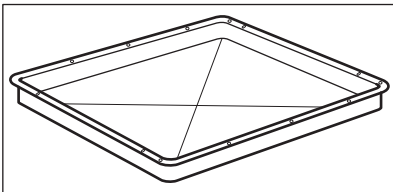

Pour les gâteaux et biscuits.

Plat à rôtir

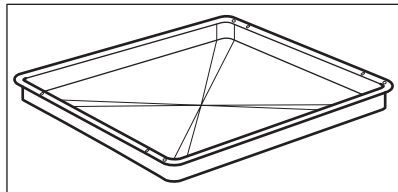

Pour cuire et rôtir ou comme plat pour récupérer la graisse.

4. BANDEAU DE COMMANDE

4.1 Manettes rétractables

Pour utiliser l'appareil, appuyez sur la manette. La manette sort alors de son logement.

4.2 Touches sensibles

—	Pour régler l'heure.
⌚	Pour régler une fonction de l'horloge.
+	Pour régler l'heure.

4.3 Affichage

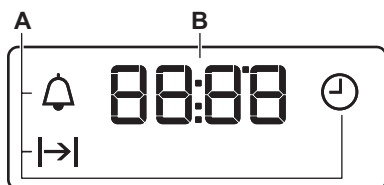

- A. Fonctions de l'horloge
- B. Minuteur

5. AVANT LA PREMIÈRE UTILISATION

⚠ AVERTISSEMENT!

Reportez-vous aux chapitres concernant la sécurité.

5.1 Avant la première utilisation

Une odeur et de la fumée peuvent s'échapper du four durant le préchauffage. Assurez-vous que la pièce est ventilée.



Étape 1

Réglez l'horloge



Étape 2

Nettoyez le four





Étape 3

Préchauffez le four à vide

1. **+**, **-** - appuyez pour régler l'heure. Après environ 5 s, le symbole cesse de clignoter et l'heure s'affiche.

1. Retirez du four les accessoires et les supports de grille amovibles.
2. Nettoyez le four et les accessoires avec un chiffon en microfibre, de l'eau chaude et un détergent doux.

1. Réglez la température maximale pour la fonction : .
Durée : 1 h.
2. Réglez la température maximale pour la fonction : .
Durée : 15 min.

Éteignez le four et attendez qu'il soit froid. Placez les accessoires et les supports de grille amovibles dans le four.

6. UTILISATION QUOTIDIENNE

AVERTISSEMENT!

Reportez-vous aux chapitres concernant la sécurité.





6.1 Comment régler : Mode de cuisson

Étape 1 Tournez la manette des modes de cuisson pour sélectionner un mode de cuisson.

Étape 2 Tournez la manette pour sélectionner la température.

Étape 3 Une fois la cuisson terminée, tournez les manettes sur la position Arrêt pour éteindre le four.

6.2 Modes de cuisson

Mode de cuisson	Application
	Le four est à l'arrêt.
	Pour allumer l'éclairage.
	Pour faire cuire sur 3 niveaux en même temps et pour sécher des aliments.
	Diminuez les températures du four de 20 à 40 °C par rapport à Chauffage Haut/Bas.

Position Arrêt







Eclairage four

Chaleur tournante

Le four est à l'arrêt.

Pour allumer l'éclairage.

Pour faire cuire sur 3 niveaux en même temps et pour sécher des aliments.
Diminuez les températures du four de 20 à 40 °C par rapport à Chauffage Haut/Bas.

Mode de cuisson	Application
	Pour cuire des pizzas. Pour faire dorer de façon intensive et obtenir un dessous croustillant.
	Pour cuire et rôtir des aliments sur un seul niveau.
	Pour cuire des gâteaux avec dessous croustillant et pour sécher des aliments.
	Pour décongeler des aliments (fruits et légumes). Le temps de décongélation dépend de la quantité et de la grosseur des plats surgelés.
	Cette fonction est conçue pour économiser de l'énergie en cours de cuisson. Lorsque vous utilisez cette fonction, la température à l'intérieur de la cavité peut différer de la température sélectionnée. La chaleur résiduelle est utilisée. La puissance peut être réduite. Pour plus d'informations, consultez la partie sur les remarques du chapitre « Utilisation quotidienne ». Chaleur tournante humide.
	Pour faire griller des aliments peu épais et du pain.

Fonction Pizza

Chauffage Haut/Bas

Cuisson de sole

Décongélation

Chaleur tournante humide

Gril

Pour cuire des pizzas. Pour faire dorer de façon intensive et obtenir un dessous croustillant.

Pour cuire et rôtir des aliments sur un seul niveau.

Pour cuire des gâteaux avec dessous croustillant et pour sécher des aliments.

Pour décongeler des aliments (fruits et légumes). Le temps de décongélation dépend de la quantité et de la grosseur des plats surgelés.

Cette fonction est conçue pour économiser de l'énergie en cours de cuisson. Lorsque vous utilisez cette fonction, la température à l'intérieur de la cavité peut différer de la température sélectionnée. La chaleur résiduelle est utilisée. La puissance peut être réduite. Pour plus d'informations, consultez la partie sur les remarques du chapitre « Utilisation quotidienne ». Chaleur tournante humide.

Pour faire griller des aliments peu épais et du pain.

Mode de cuisson	Application
-----------------	-------------



Turbo grill

Pour rôtir de gros morceaux de viande ou de volaille avec os sur un seul niveau. Pour gratiner et faire dorer.



Pour certaines fonctions du four, l'éclairage peut s'éteindre automatiquement à une température inférieure à 60 °C.

6.3 Remarques sur : Chaleur tournante humide

Cette fonction était utilisée pour se conformer à la classe d'efficacité énergétique et aux



exigences Ecodesign (selon les normes EU 65/2014 et EU 66/2014). Tests conformes à la norme : IEC/EN 60350-1.

La porte du four doit être fermée pendant la cuisson pour que la fonction ne soit pas interrompue et que le four fonctionne avec la plus grande efficacité énergétique possible.

Pour consulter les instructions de cuisson, reportez-vous au chapitre « Conseils », Chaleur tournante humide. Pour obtenir des recommandations générales sur l'économie d'énergie, reportez-vous au chapitre « Efficacité énergétique », « Économie d'énergie ».

7. FONCTIONS DE L'HORLOGE



7.1 Fonctions de l'horloge

Fonction de l'horloge	Utilisation
 Heure actuelle	Pour régler, changer ou vérifier l'heure.
 Durée	Pour régler la durée de fonctionnement du four.
 Minuteur	Pour régler la minuterie. Cette fonction est sans effet sur le fonctionnement du four. Vous pouvez régler cette fonction à tout moment, même quand le four est éteint.



7.2 Comment régler : Fonctions de l'horloge

Comment régler : Heure actuelle



 - clignote lorsque vous branchez le four à l'alimentation électrique, lorsqu'il y a eu une coupure de courant ou que le minuteur n'est pas réglé.

 ,  - appuyez pour régler l'heure.
Après environ 5 s, le symbole cesse de clignoter et l'heure s'affiche.

Comment modifier : Heure actuelle



Étape 1  - appuyez à plusieurs reprises pour modifier l'heure actuelle.  - commence à clignoter.





Comment modifier : Heure actuelle

Étape 2  ,  - appuyez pour régler l'heure.
Après environ 5 s, le symbole cesse de clignoter et l'heure s'affiche.

Comment régler : Durée

Étape 1 Sélectionnez la fonction et la température du four.



Étape 2  - appuyez à plusieurs reprises.  - commence à clignoter.



Étape 3  ,  - appuyez pour régler la durée.
L'affichage indique :  |.
 | - clignote lorsque la durée définie est écoulée. Le signal sonore retentit et le four s'éteint.

Étape 4 Appuyez sur n'importe quelle touche pour arrêter le signal sonore.

Étape 5 Tournez la manette sur la position Arrêt.

Comment régler : Minuteur

Étape 1  - appuyez à plusieurs reprises.  - commence à clignoter.

Étape 2  ,  - appuyez pour régler l'heure.
La fonction démarre automatiquement au bout de 5 s.
Lorsque la durée définie s'est écoulée, un signal sonore retentit.

Étape 3 Appuyez sur n'importe quelle touche pour arrêter le signal sonore.

Étape 4 Tournez la manette sur la position Arrêt.

Comment annuler : Fonctions de l'horloge

Étape 1  - appuyez plusieurs fois jusqu'à ce que le symbole de la fonction horloge se mette à clignoter.

Étape 2 Maintenez la touche  .
La fonction horloge est désactivée au bout de quelques secondes.

8. UTILISATION DES ACCESSOIRES



AVERTISSEMENT!

Reportez-vous aux chapitres concernant la sécurité.

8.1 Insertion des accessoires

Une petite indentation sur le dessus apporte plus de sécurité. Les indentations sont

également des dispositifs anti-bascule. Le rebord élevé de la grille empêche les ustensiles de cuisine de glisser sur la grille.

Grille métallique:

Poussez la grille entre les barres de guidage des supports de grille.

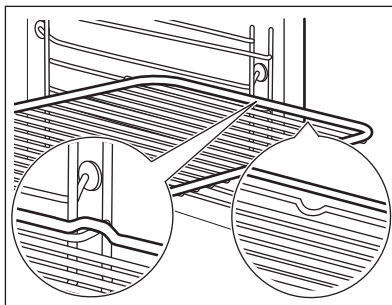
**Plateau de cuisson / Plat à rôtir:**

Poussez la plaque entre les rails du support de grille.

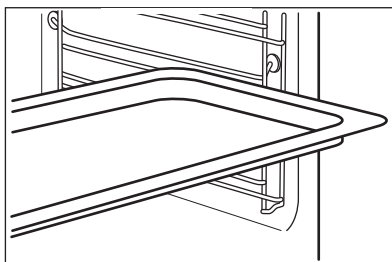

9. FONCTIONS SUPPLÉMENTAIRES

9.1 Ventilateur de refroidissement

Lorsque l'appareil fonctionne, le ventilateur de refroidissement se met automatiquement en marche pour refroidir les surfaces de

l'appareil. Si vous éteignez l'appareil, le ventilateur de refroidissement peut continuer à fonctionner jusqu'à ce que l'appareil refroidisse.

10. CONSEILS ET ASTUCES



Reportez-vous aux chapitres concernant la sécurité.

10.1 Recommandations de cuisson



Les températures et temps de cuisson se trouvant dans les tableaux ne sont indiqués qu'à titre indicatif. Ils varient selon les recettes, la qualité et la quantité des ingrédients utilisés.

Votre appareil peut cuire ou rôtir les aliments différemment de l'appareil que vous aviez auparavant. Les conseils ci-dessous contiennent les réglages de température, les temps de cuisson et les positions de grilles recommandés pour des types de plats en particulier.

Si vous ne trouvez pas les réglages appropriés pour une recette spécifique, cherchez-en une qui s'en rapproche.

10.2 Cuisson

Pour la première cuisson, utilisez la température inférieure.

Le temps de cuisson peut être prolongé de 10 à 15 minutes, si vous cuisez des gâteaux sur plusieurs niveaux.

Les gâteaux et petites pâtisseries placés à différentes hauteurs ne dorent pas toujours





de manière homogène. S'ils ne dorent uniformément, il n'est pas nécessaire de modifier la température. Les différences s'atténuent en cours de cuisson.





Les plateaux insérés dans le four peuvent se déformer en cours de cuisson. Une fois les plateaux refroidis, les déformations disparaissent.

10.3 Conseils de cuisson

Résultats de cuisson	Cause possible	Solution
Le dessous du gâteau n'est pas suffisamment cuit.	La position de la grille est incorrecte.	Placez le gâteau sur un niveau plus bas.
Le gâteau s'affaisse et devient mou ou plein de grumeaux.	La température du four est trop élevée.	La prochaine fois, réglez une température du four légèrement plus basse.
	Température du four trop élevée et durée de cuisson trop courte.	Réglez une température de cuisson légèrement inférieure et un temps de cuisson plus long la prochaine fois.
Le gâteau est trop sec.	Température de cuisson trop basse.	La prochaine fois, réglez une température du four plus élevée.
	Durée de cuisson trop longue.	La prochaine fois, réduisez le temps de cuisson.
La cuisson du gâteau n'est pas homogène.	Température du four trop élevée et durée de cuisson trop courte.	Réglez une température de cuisson légèrement inférieure et un temps de cuisson plus long la prochaine fois.
	La pâte à gâteau n'est pas correctement répartie.	La prochaine fois, étalez la préparation de façon homogène sur le plateau de cuisson.
Le gâteau n'est pas cuit à la fin de la durée de cuisson indiquée dans la recette.	Température de cuisson trop basse.	La prochaine fois, réglez une température du four légèrement plus élevée.

10.4 Cuisson sur un seul niveau



 CUIS- SON DANS DES MOULES		 (°C)	 (min)			
Fond de tarte - pâte sablée, préchauffer le four à vide	Chaleur tournante	170 - 180	10 - 25	2		
Fond de tarte - mélange de génoise	Chaleur tournante	150 - 170	20 - 25	2		

 CUISON DANS DES MOULES			 (°C)	 (min)	
Kouglof / Brioche	Chaleur tournante		150 - 160	50 - 70	1
Cake de madère / Cakes aux fruits	Chaleur tournante		140 - 160	70 - 90	1
Gâteau au fromage	Chauffage Haut/Bas		170 - 190	60 - 90	1

Utilisez le troisième niveau de la grille.

Utilisez la fonction : Chaleur tournante.





Utilisez un plateau de cuisson.

 GÂTEAUX / PÂTISSERIES / PAINS		 (°C)	 (min)
Gâteau avec garniture à base de crumble		150 - 160	20 - 40
Tartes aux fruits (à base de pâte levée/mélange de génoise), utilisez un plat à rôtir		150	35 - 55
Tartes aux fruits à base de pâte sablée		160 - 170	40 - 80

Préchauffez le four à vide.

Utilisez la fonction : Chauffage Haut/Bas.

Utilisez un plateau de cuisson.

 GÂTEAUX / PÂTISSERIES / PAINS		 (°C)	 (min)	
Gâteau Roulé		180 - 200	10 - 20	3
Pain de seigle:	d'abord : 230		20	1
	puis : 160 - 180		30 - 60	
Gâteau aux amandes beurré / Gâteaux au sucre		190 - 210	20 - 30	3
Choux à la crème / Éclairs		190 - 210	20 - 35	3
Pain tressé / Pain en forme de couronne		170 - 190	30 - 40	3
Tartes aux fruits (à base de pâte levée/mélange de génoise), utilisez un plat à rôtir	170		35 - 55	3



GÂTEAUX / PÂTISSERIES / PAINS



(°C)



(min)



Gâteaux à base de levure avec garnitures délicates (par ex. fromage blanc, crème, crème anglaise)

160 - 180

40 - 80

3

Brioche de Noël

160 - 180

50 - 70

2

Utilisez le troisième niveau de la grille.



BISCUITS



(°C)



(min)

Biscuits sablés

Chaleur tournante

150 - 160

10 - 20

Petits pains, préchauffer le four à vide

Chaleur tournante

160

10 - 25

Biscuits à base de mélange de génoise

Chaleur tournante

150 - 160

15 - 20

Pâte feuilletée, préchauffer le four à vide

Chaleur tournante

170 - 180

20 - 30

Biscuits à base de pâte levée

Chaleur tournante

150 - 160

20 - 40

Meringues

Chaleur tournante

100 - 120

30 - 50

Petites pâtisseries à base de blanc d'œuf / Meringues

Chaleur tournante

80 - 100

120 - 150

Petits pains, préchauffer le four à vide

Chauffage Haut/Bas

190 - 210

10 - 25

10.5 Gratins

Utilisez le premier niveau de la grille.



(°C)



(min)

Baguettes nappées de fromage fondu

Chaleur tournante

160 - 170

15 - 30

Gratin de légumes, préchauffer le four à vide

Turbo grill

160 - 170

15 - 30

Lasagnes

Chauffage Haut/Bas

180 - 200

25 - 40

Gratins de poisson

Chauffage Haut/Bas

180 - 200





30 - 60

Légumes farcis

Chaleur tournante

160 - 170





30 - 60





		 (°C)	 (min)
Gâteaux sucrés	Chauffage Haut/Bas	180 - 200	40 - 60
Pâtes au four	Chauffage Haut/Bas	180 - 200	45 - 60

10.6 Cuisson sur plusieurs niveaux

Utilisez la fonction : Chaleur tournante.

Utilisez les plateaux de cuisson.

 GÂTEAUX / PÂTISSERIES	 (°C)	 (min)	 2 positions
Choux à la crème / Éclairs, préchauffer le four à vide	160 - 180	25 - 45	1 / 4
Crumble sec	150 - 160	30 - 45	1 / 4

 BIS- CUITS / PETITS GÂTEAUX / VIENNOISE- RIES / ROULÉS	 (°C)	 (min)	 2 positions	 3 positions
Petits pains	180	20 - 30	1 / 4	-
Biscuits sablés	150 - 160	20 - 40	1 / 4	1 / 3 / 5
Biscuits à base de mélange de génoise	160 - 170	25 - 40	1 / 4	-
Pâte feuilletée, pré- chauffer le four à vi- de	170 - 180	30 - 50	1 / 4	-
Biscuits à base de pâte levée	160 - 170	30 - 60	1 / 4	-
Meringues	100 - 120	40 - 80	1 / 4	-
Biscuits à base de blanc d'œuf / Merin- gues	80 - 100	130 - 170	1 / 4	-

10.7 Conseils de rôtissage

Utilisez des plats résistant à la chaleur.

Viande maigre rôtie couverte (vous pouvez utiliser du papier aluminium).

Faites rôtir les gros morceaux de viande directement sur le plateau.

Pour éviter que les graisses de cuisson ne brûlent, versez un peu d'eau dans le plat à rôtir.

Si nécessaire, retournez le rôti à la moitié ou aux deux tiers du temps de cuisson.







Faites rôtir la viande et le poisson par gros morceaux (au moins 1 kg).







Si le niveau un est suggéré, placez les aliments directement sur le plateau de cuisson

Arrosez les morceaux de viande avec leur propre jus de cuisson plusieurs fois durant la cuisson.

10.8 Rôtissage

Utilisez le premier niveau de la grille.

 BŒUF				
			 (°C)	 (min)
Bœuf braisé	1 - 1,5 kg	Chauffage Haut/Bas	230	120 - 150
Rôti ou filet de bœuf, saignant, préchauffer le four à vide	par cm d'épaisseur	Turbo grill	190 - 200	5 - 6
Rôti ou filet de bœuf, à point, préchauffer le four à vide	par cm d'épaisseur	Turbo grill	180 - 190	6 - 8
Rôti ou filet de bœuf, bien cuit, préchauffer le four à vide	par cm d'épaisseur	Turbo grill	170 - 180	8 - 10

 PORC				
 Utilisez la fonction : Turbo grill.				
	 (kg)	 (°C)	 (min)	
Épaule / Cou / Noix de jambon	1 - 1.5		160 - 180	90 - 120
Côtelettes / Travers de porc	1 - 1.5		170 - 180	60 - 90
Rôti haché	0.75 - 1		160 - 170	50 - 60
Jarret de porc, précuit	0.75 - 1		150 - 170	90 - 120



VEAU



Utilisez la fonction : Turbo grill.



(kg)



(°C)



(min)

Rôti de veau

1

160 - 180

90 - 120

Jarret de veau

1.5 - 2

160 - 180

120 - 150



AGNEAU



Utilisez la fonction : Turbo grill.



(kg)



(°C)



(min)

Gigot d'agneau / Rôti d'agneau

1 - 1.5

150 - 170

100 - 120

Râble d'agneau

1 - 1.5

160 - 180

40 - 60



GIBIER



Utilisez la fonction : Chauffage Haut/Bas.



(kg)



(°C)



(min)

Râble / Cuisse de lièvre, préchauffer le four à vide

jusqu'à 1

230

30 - 40

Râble de cerf

1.5 - 2

210 - 220

35 - 40

Cuissot de chevreuil

1.5 - 2

180 - 200

60 - 90



VOLAILLE



Utilisez la fonction : Turbo grill.



(kg)



(°C)



(min)

	(kg)	(°C)	(min)
Volaille, portions	0,2 - 0,25 chacun	200 - 220	30 - 50
Poulet, moitié	0,4 - 0,5 chacun	190 - 210	35 - 50
Poulet, poularde	1 - 1.5	190 - 210	50 - 70
Canard	1.5 - 2	180 - 200	80 - 100
Oie	3.5 - 5	160 - 180	120 - 180
Dinde	2.5 - 3.5	160 - 180	120 - 150
Dinde	4 - 6	140 - 160	150 - 240



POISSON (À LA VAPEUR)



Utilisez la fonction : Chauffage Haut/Bas.



(kg)



(°C)



(min)

	(kg)	(°C)	(min)
Poisson entier	1 - 1.5	210 - 220	40 - 60

10.9 Cuisson croustillante avec la fonction : Fonction Pizza



PIZZA



Utilisez le premier niveau de la grille.



(°C)



(min)

	(°C)	(min)
Tartes	180 - 200	40 - 55
Flan d'épinards	160 - 180	45 - 60
Quiche lorraine / Flan suisse	170 - 190	45 - 55



PIZZA



Utilisez le premier niveau de la grille.



(°C)



(min)

Gâteau au fromage	140 - 160	60 - 90
Tarte aux légumes	160 - 180	50 - 60



PIZZA



Avant la cuisson, faites préchauffer votre four vide.



Utilisez le deuxième niveau de la grille.



(°C)



(min)

Pizza, croûte fine, utilisez un plat à rôtir 200 - 230 15 - 20

Pizza, croûte épaisse 180 - 200 20 - 30

Pain sans levain 230 - 250 10 - 20

Flan de pâte feuilletée 160 - 180 45 - 55

Tarte flambée 230 - 250 12 - 20



PIZZA



Avant la cuisson, faites préchauffer votre four vide.



Utilisez le deuxième niveau de la grille.



(°C)



(min)

Raviolis russes 180 - 200 15 - 25

10.10 Gril

Avant la cuisson, faites préchauffer votre four vide.

Ne faites griller que des morceaux plats de viande ou de poisson.

Placez un plat au premier niveau pour récupérer les graisses.



GRIL



Utilisez la fonction : Gril



(°C)



(min)
1re face



(min)
2e face



Rôti de bœuf 210 - 230 30 - 40 30 - 40 2

Filet de bœuf 230 20 - 30 20 - 30 3

Filet mignon de porc 210 - 230 30 - 40 30 - 40 2

Filet mignon de veau 210 - 230 30 - 40 30 - 40 2

Râble d'agneau 210 - 230 25 - 35 20 - 25 3

Poisson entier, 0,5 kg - 1 kg 210 - 230 15 - 30 15 - 30 3 / 4

10.11 Plats Surgelés



DÉCONGÉLATION



Utilisez la fonction : Chaleur tournante.



(°C)



(min)



	(°C)	(min)	
Pizza, surgelée	200 - 220	15 - 25	2
Pizza américaine, surgelée	190 - 210	20 - 25	2
Pizza, froide	210 - 230	13 - 25	2
Parts de pizza surgelées	180 - 200	15 - 30	2
Frites, fines	200 - 220	20 - 30	3
Frites, épaisses	200 - 220	25 - 35	3
Pommes quartiers / Croquettes	220 - 230	20 - 35	3
Rösti	210 - 230	20 - 30	3
Lasagnes / Cannelloni, frais	170 - 190	35 - 45	2
Lasagnes / Cannelloni, surgelés	160 - 180	40 - 60	2
Fromage cuit au four	170 - 190	20 - 30	3
Ailes de poulet	190 - 210	20 - 30	2

10.12 Décongélation

Retirez l'emballage des aliments puis placez-les dans une assiette.

Ne couvrez pas les aliments car cela peut rallonger le temps de décongélation.

Pour les grosses quantités d'aliments, placez une assiette vide retournée au fond de la

Utilisez le premier niveau de la grille.

cavité. Placez les aliments dans un plat creux, et posez le tout sur l'assiette retournée dans le four. Retirez les supports de grille si nécessaire.



(kg)



(min)

Temps de décongélation



(min)

Temps de décongélation supplémentaire







Retournez à la moitié du temps.

Poulet

1

100 - 140

20 - 30

	 (kg)	 (min) Temps de décon- gélation	 (min) Temps de décon- gélation supplé- mentaire	
Viande	1	100 - 140	20 - 30	Retournez à la moitié du temps.
Truite	0,15	25 - 35	10 - 15	-
Fraises	0,3	30 - 40	10 - 20	-
Beurre	0,25	30 - 40	10 - 15	-
Crème	2 x 0,2	80 - 100	10 - 15	La crème fraîche peut être battue même si elle n'est pas complètement décongelée.
Gâteau	1,4	60	60	-

10.13 Stérilisation

Utilisez la fonction Cuisson de sole.

Utilisez toujours des bocaux à stériliser de dimensions identiques, disponibles dans le commerce.

N'utilisez pas de bocaux à couvercles à visser ou à baïonnette, ni de boîtes métalliques.

Utilisez le premier niveau de la grille.

Ne mettez pas plus de six bocaux à conserves d'un litre sur le plateau de cuisson.



Remplissez les bocaux au même niveau et enclenchez le système de fermeture.



Les bocaux ne doivent pas se toucher.



Mettez environ 1/2 litre d'eau dans le plateau de cuisson pour humidifier le four.

Lorsque le liquide contenu dans les pots commence à frémir (au bout d'environ 35 à 60 minutes pour des pots d'un litre), éteignez le four ou réduisez la température à 100 °C (reportez-vous au tableau).

Réglez la température sur 160 - 170 °C.

 BAIES	 (min) Cuisson jusqu'à ce que la préparation commence à frémir
Fraises / Myrtilles / Framboises / Groseilles à maquereau mûres	35 - 45

 FRUITS À NOYAU	 (min) Cuisson jusqu'à ce que la préparation commence à frémir	 (min) Continuez la cuisson à 100 °C
Pêches / Coings / Prunes	35 - 45	10 - 15

LÉ- GUMES	 (min)	 (min)
	Cuisson jusqu'à ce que la préparation commence à frémir	Continuez la cuisson à 100 °C
Carottes	50 - 60	5 - 10
Concombres	50 - 60	-
Conserves au vinaigre	50 - 60	5 - 10
Chou-rave / Petits pois / Asperges	50 - 60	15 - 20

10.14 Déshydratation - Chaleur tournante

Couvrez les plateaux avec du papier sulfurisé ou du papier de cuisson.

Pour de meilleurs résultats, arrêtez le four à mi-cuisson, ouvrez la porte et laissez-la refroidir pendant une nuit pour terminer le séchage.

Pour un plateau, utilisez le troisième niveau de la grille.

10.15 Chaleur tournante humide - accessoires recommandés

Utilisez les moules et récipients foncés et non réfléchissants. Ils offrent une meilleure absorption de la chaleur que les plats réfléchissants de couleur claire.



Plaque à pizza

Sombre, non réfléchissant
Diamètre de 28 cm



Plat de cuisson

Sombre, non réfléchissant
Diamètre : 26 cm



Ramequins



Céramique
8 cm de diamètre,
5 cm de hauteur



Moule pour fond de tarte

Sombre, non réfléchissant
Diamètre de 28 cm

Pour deux plateaux, utilisez les premier et quatrième niveaux de la grille.





LÉGUMES	 (°C)	 (h)
	Haricots	60 - 70
Poivrons	60 - 70	5 à 6
Légumes pour soupe	60 - 70	5 à 6
Champignons	50 - 60	6 - 8
Herbes	40 - 50	2 à 3

Réglez la température sur 60 - 70 °C.

FRUITS	 (h)
	Prunes
Abricots	8 à 10
Tranches de pommes	6 - 8
Poires	6 à 9

10.16 Chaleur tournante humide





Pour de meilleurs résultats, suivez les suggestions indiquées dans le tableau ci-dessous.

	 (°C)	 (min)	
Gressins, 0,5 kg au total	190 - 200	50 - 60	3
Coquilles Saint-Jacques cuites au four	180 - 200	30 - 40	4
Poisson entier en sel, 0,3 - 0,5 kg	190 - 200	45 - 50	4
Poisson entier en papier sulfurisé, 0,3 - 0,5 kg	190 - 200	50 - 60	3
Amaretti (20 ; 0,5 kg au total)	170 - 180	40 - 50	3
Crumble aux pommes	190 - 200	50 - 60	4
Muffins au chocolat (20 ; 0,5 kg au total)	160 - 170	35 - 45	3

10.17 Informations pour les organismes de contrôle





Tests conformes aux normes : EN 60350, IEC 60350.

Cuisson sur un niveau - cuisson en moule





		 °C	 min	
Génoise allégée	Chaleur tournante	160	45 - 60	2
Génoise allégée	Chauffage Haut/Bas	160	45 - 60	2
Tarte aux pommes, 2 moules Ø20 cm	Chaleur tournante	160	55 - 65	2
Tarte aux pommes, 2 moules Ø20 cm	Chauffage Haut/Bas	180	55 - 65	1
Sablé	Chaleur tournante	140	25 - 35	2
Sablé	Chauffage Haut/Bas	140	25 - 35	2

Cuisson sur un niveau - biscuits

Utilisez le troisième niveau de la grille.

		 °C	 min
Petits gâteaux, 20 par plateau, préchauffer le four à vide	Chaleur tournante	150	20 - 30
Petits gâteaux, 20 par plateau, préchauffer le four à vide	Chauffage Haut/Bas	170	20 - 30





Cuisson sur plusieurs niveaux - biscuits

		 °C	 min	
Sablé	Chaleur tournante	140	25 - 45	2 / 4
Petits gâteaux, 20 par plateau, préchauffer le four à vide	Chaleur tournante	150	25 - 35	1 / 4
Génoise allégée	Chaleur tournante	160	45 - 55	2 / 4
Tarte aux pommes, 1 pain moulé par grille (Ø 20 cm)	Chaleur tournante	160	55 - 65	2 / 4

Gril

Préchauffez le four vide pendant 5 minutes.

Réglez le gril à la température maximale.

		 min	
Pain grillé	Gril	1 - 2	5
Steak de bœuf, tourner à mi-cuisson	Gril	24 - 30	4

11. ENTRETIEN ET NETTOYAGE



AVERTISSEMENT!

Reportez-vous aux chapitres concernant la sécurité.

11.1 Remarques concernant le nettoyage



Agent nettoyant

Nettoyez l'avant de l'appareil uniquement avec un chiffon en microfibre imbibé d'eau tiède et d'un détergent doux.

Utilisez une solution de nettoyage pour nettoyer les surfaces métalliques.

Nettoyez les taches avec un détergent doux.



Utilisation quotidienne

Nettoyez la cavité après chaque utilisation. L'accumulation de graisse ou d'autres résidus peut provoquer un incendie.

Ne conservez pas les aliments dans l'appareil pendant plus de 20 minutes. Séchez la cavité uniquement avec un chiffon en microfibre après chaque utilisation.



Nettoyez tous les accessoires après chaque utilisation et laissez-les sécher. Utilisez uniquement un chiffon en microfibre avec de l'eau tiède et un détergent doux. Ne lavez pas les accessoires au lave-vaisselle .

Ne nettoyez pas les accessoires anti-adhésifs avec un produit nettoyant abrasif ou des objets tranchants.

Accessoires

11.2 Comment retirer : Supports de grille

Retirez les supports de grille pour nettoyer le four.

Étape 1 Éteignez le four et attendez qu'il soit froid.

Étape 2 Écartez l'avant du support de grille de la paroi latérale.

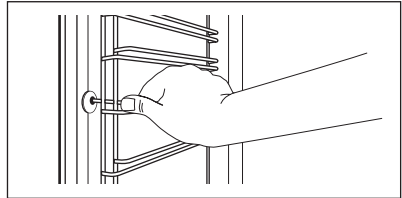

Étape 3 Écartez l'arrière du support de grille de la paroi latérale et retirez-le.

Étape 4 Installez les supports de grille dans l'ordre inverse.

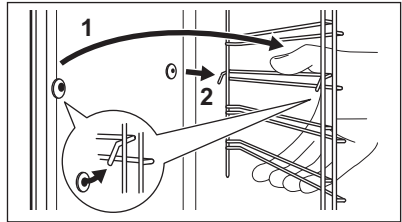

11.3 Comment enlever : Gril



AVERTISSEMENT!

Risque de brûlure !

Étape 1 Éteignez le four et attendez qu'il soit froid pour le nettoyer.
Retirez les supports de grille.

Étape 2 Saisissez les coins de la grille. Tirez-la vers l'avant en surmontant la pression du ressort et sortez-la des deux supports. Le gril se replie.

Étape 3 Nettoyez la voûte du four avec de l'eau chaude, un chiffon doux et un détergent doux. Laissez-la sécher.

Étape 4 Installez le gril selon la même procédure, mais dans l'ordre inverse.

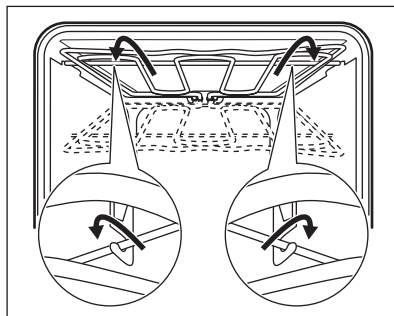

Étape 5 Installez les supports de grille.

11.4 Comment démonter et installer : Porte

Vous pouvez retirer la porte ainsi que les panneaux de verre intérieurs pour les nettoyer. Le nombre de vitres diffère selon les modèles.

⚠ AVERTISSEMENT!

La porte est lourde.

⚠ ATTENTION!

Manipulez soigneusement la vitre, en particulier autour des bords du panneau avant. Le verre peut se briser.

Étape 1 Ouvrez entièrement la porte.

Étape 2 Soulevez et appuyez sur les leviers de blocage (A) sur les deux charnières de la porte.

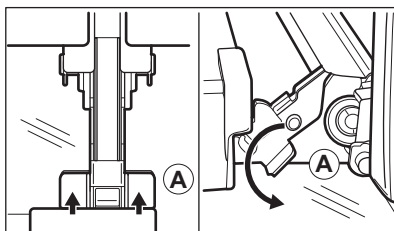

Étape 3 Fermez la porte du four à la première position (à un angle d'environ 70°). Tenez la porte des deux côtés et retirez-la du four en la soulevant. Posez la porte, face extérieure vers le bas, sur un linge doux posé sur une surface stable.

Étape 4 Tenez la garniture de porte (B) sur le bord supérieur de la porte des deux côtés et poussez vers l'intérieur pour libérer le joint du clip.

Étape 5 Retirez le cache de la porte en le tirant vers l'avant.

Étape 6 Saisissez les panneaux de verre de la porte par leur bord supérieur un par un et dégagez-les du guide.

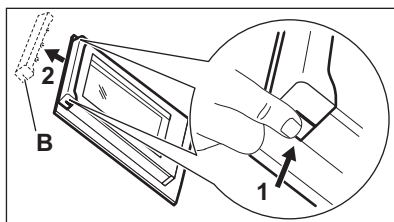

Étape 7 Nettoyez la vitre à l'eau savonneuse. Essuyez soigneusement la vitre. Ne passez pas les panneaux en verre au lave-vaisselle.

Étape 8 Après le nettoyage, effectuez les étapes ci-dessus dans le sens inverse.

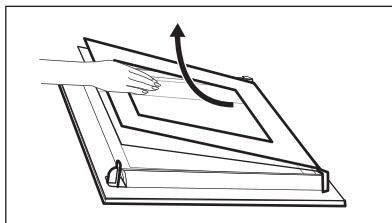

Étape 9 Installez d'abord le plus petit des panneaux, puis le plus grand, et terminez par la porte. Assurez-vous que les panneaux en verre sont insérés dans la bonne position, car la surface de la porte pourrait surchauffer.

11.5 Comment remplacer : Éclairage

AVERTISSEMENT!

Risque d'électrocution.
L'éclairage peut être chaud.

Avant de remplacer l'éclairage :

Étape 1

Éteignez le four. Attendez que le four ait refroidi.

Étape 2

Débranchez le four de l'alimentation secteur.

Étape 3

Placez un chiffon au fond de la cavité.

Lampe supérieure

Étape 1 Tournez le diffuseur en verre pour le retirer.

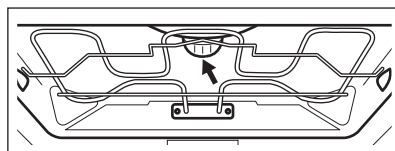

Étape 2 Nettoyez le diffuseur en verre.

Étape 3 Remplacez l'ampoule par une ampoule adéquate résistant à une température de 300 °C.

Étape 4 Installez le diffuseur en verre.

12. DÉPANNAGE

AVERTISSEMENT!

Reportez-vous aux chapitres concernant la sécurité.

12.1 Que faire si...

Dans tous les cas ne figurant pas dans ce tableau, veuillez contacter un service après-vente agréé.

Problème	Vérifiez si...
Le four ne chauffe pas.	Le fusible a disjoncté.
L'affichage indique « 12.00 ».	Une coupure de courant s'est produite. Réglez l'heure actuelle.

Problème	Vérifiez si...
L'éclairage ne fonctionne pas.	L'ampoule est grillée.

12.2 Données de maintenance

Si vous ne trouvez pas de solution au problème, veuillez contacter votre revendeur ou un service après-vente agréé.

Les informations nécessaires au service après-vente figurent sur la plaque signalétique. La plaque signalétique se trouve sur le cadre avant de la cavité de l'appareil. Ne retirez pas la plaque signalétique de la cavité de l'appareil.

Nous vous recommandons d'écrire les informations ici :

Modèle (Mod.)

Référence produit (PNC)

Numéro de série (SN)

13. RENDEMENT ÉNERGÉTIQUE

13.1 Informations sur le produit et fiche d'information sur le produit conformément aux réglementations européennes sur l'écoconception et l'étiquetage énergétique

Nom du fournisseur	AEG	
Identification du modèle	BEK435060B 944188455 EB40B 944188534	
Indice d'efficacité énergétique	81.2	
Classe d'efficacité énergétique	A+	
Consommation d'énergie avec charge standard, en mode conventionnel	0.99kWh/cycle	
Consommation d'énergie avec charge standard, en mode chaleur tournante	0.69kWh/cycle	
Nombre de cavités	1	
Source de chaleur	Électricité	
Volume	71l	
Type de four	Four encastrable	
Masse	BEK435060B	33.0kg
	EB40B	33.0kg

13.2 Économie d'énergie



Cet appareil est doté de caractéristiques qui vous permettent d'économiser de l'énergie lors de votre cuisine au quotidien.

Assurez-vous que la porte de l'appareil est fermée lorsque l'appareil est en fonctionnement. Évitez d'ouvrir l'appareil trop souvent pendant la cuisson. Nettoyez régulièrement le joint de porte et assurez-vous qu'il est bien en place.

Utilisez des plats en métal pour accroître les économies d'énergie.

Dans la mesure du possible, ne préchauffez pas l'appareil avant la cuisson.

Lorsque vous préparez plusieurs plats à la fois, faites en sorte que les pauses entre les cuissons soient aussi courtes que possible.

Cuisson avec ventilation

Si possible, utilisez les fonctions de cuisson avec la ventilation pour économiser de l'énergie.

Chaleur résiduelle

Si la cuisson doit durer plus de 30 minutes, réduisez la température de l'appareil au minimum 3 à 10 minutes avant la fin de la cuisson. La chaleur résiduelle à l'intérieur de l'appareil poursuivra la cuisson.

Utilisez la chaleur résiduelle pour réchauffer d'autres plats.

Maintien des aliments au chaud

Sélectionnez la température la plus basse possible pour utiliser la chaleur résiduelle et maintenir le repas au chaud.

Chaleur tournante humide

Fonction conçue pour économiser de l'énergie en cours de cuisson.

14. EN MATIÈRE DE PROTECTION DE L'ENVIRONNEMENT

Recyclez les matériaux portant le symbole . Déposez les emballages dans les conteneurs prévus à cet effet. Contribuez à la protection de l'environnement et à votre sécurité, recyclez vos produits électriques et électroniques. Ne jetez pas les appareils

portant le symbole  avec les ordures ménagères. Emmenez un tel produit dans votre centre local de recyclage ou contactez vos services municipaux.

FR Concerne la France uniquement :



FR

Cet appareil, ses accessoires et cordons se recyclent



Points de collecte sur www.quefairedesdechets.fr
Privilégiez la réparation ou le don de votre appareil !



FR



FÜR PERFEKTE ERGEBNISSE

Danke, dass Sie sich für dieses AEG Produkt entschieden haben. Wir haben es geschaffen, damit Sie viele Jahre von seiner ausgezeichneten Leistung und den innovativen Technologien, die Ihnen das Leben erleichtern, profitieren können. Es ist mit Funktionen ausgestattet, die in gewöhnlichen Geräten nicht vorhanden sind. Bitte nehmen Sie sich ein paar Minuten Zeit, um das Beste aus ihm herauszuholen.

Besuchen Sie uns auf unserer Website, um:



Anwendungshinweise, Prospekte, Informationen zu Fehlerbehebung, Service und Reparatur zu erhalten:

www.aeg.com/support



Registrieren Sie Ihr Produkt, um einen erstklassigen Service zu erhalten:

www.registreaeg.com



Um Zubehör, Verbrauchsmaterial und Original-Ersatzteile für Ihr Gerät zu kaufen:

www.aeg.com/shop

KUNDENDIENST UND SERVICE

Verwenden Sie immer Original-Ersatzteile.

Halten Sie folgende Angaben bereit, wenn Sie sich an einen autorisierten Kundendienst wenden: Modell, PNC, Seriennummer.

Die Daten finden Sie auf dem Typenschild.

 Warnungs-/Sicherheitshinweise

 Allgemeine Informationen und Empfehlungen

 Informationen zum Umweltschutz

Änderungen vorbehalten.

INHALTSVERZEICHNIS

1. SICHERHEITSHINWEISE.....	145
2. SICHERHEITSANWEISUNGEN.....	147
3. GERÄTEBESCHREIBUNG.....	150
4. BEDIENFELD.....	150
5. VOR DER ERSTEN INBETRIEBNAHME.....	151
6. TÄGLICHER GEBRAUCH.....	152
7. UHRFUNKTIONEN.....	153
8. VERWENDUNG DES ZUBEHÖRS.....	154
9. ZUSATZFUNKTIONEN.....	155
10. TIPPS UND HINWEISE.....	155
11. REINIGUNG UND PFLEGE.....	168
12. FEHLERSUCHE.....	171
13. ENERGIEEFFIZIENZ.....	172
14. INFORMATIONEN ZUR ENTSORGUNG.....	173

1. ⚠ SICHERHEITSHINWEISE

Lesen Sie vor der Montage und dem Gebrauch des Geräts zuerst die Bedienungsanleitung. Bei Verletzungen oder Schäden infolge nicht ordnungsgemäßer Montage oder Verwendung übernimmt der Hersteller keine Haftung. Bewahren Sie die Anleitung zum Nachschlagen an einem sicheren und zugänglichen Ort auf.

1.1 Sicherheit von Kindern und schutzbedürftigen Personen

- Das Gerät kann von Kindern ab 8 Jahren und Personen mit eingeschränkten physischen, sensorischen oder geistigen Fähigkeiten oder mit mangelnder Erfahrung/mangelndem Wissen benutzt werden, wenn sie durch eine für ihre Sicherheit zuständige Person beaufsichtigt werden oder von dieser Person Anweisungen erhalten haben, wie das Gerät sicher zu bedienen ist und welche Gefahren bei nicht ordnungsgemäßer Bedienung bestehen. Kinder unter 8 Jahren und Personen mit schweren Behinderungen oder Mehrfachbehinderung sollten vom Gerät ferngehalten werden, wenn sie nicht ständig beaufsichtigt werden.
- Kinder sollten beaufsichtigt werden, um sicherzustellen, dass sie nicht mit dem Gerät.
- Halten Sie sämtliches Verpackungsmaterial von Kindern fern und entsorgen Sie es ordnungsgemäß.
- **WARNUNG:** Das Gerät und die zugänglichen Geräteteile werden während des Betriebs heiß. Halten Sie Kinder und Haustiere von dem Gerät fern, wenn es in Betrieb oder in der Abkühlphase ist.
- Falls Ihr Gerät mit einer Kindersicherung ausgestattet ist, empfehlen wir, diese einzuschalten.
- Kinder dürfen keine Reinigung und Wartung des Geräts ohne Beaufsichtigung durchführen.

1.2 Allgemeine Sicherheit

- Dieses Gerät ist nur zum Kochen bestimmt.
- Dieses Gerät ist für den Hausgebrauch in einem Einfamilienhaus in Innenräumen bestimmt.
- Dieses Gerät darf in Büros, Hotelzimmern, Gästezimmern in Pensionen, Bauernhöfen und anderen ähnlichen Unterkünften verwendet werden, wenn diese Nutzung das (durchschnittliche) Nutzungsniveau im Haushalt nicht überschreitet.
- Die Montage des Geräts und der Austausch des Kabels muss von einer Fachkraft vorgenommen werden.
- Verwenden Sie das Gerät nicht, bevor es in den Einbauschrank gesetzt wird.
- Vor Wartungsarbeiten ist das Gerät von der elektrischen Stromversorgung zu trennen.
- Wenn das Netzkabel beschädigt ist, muss es vom Hersteller, seinem autorisierten Kundenservice oder einer gleichermaßen qualifizierten Person ausgetauscht werden, um Gefahren durch elektrischen Strom zu vermeiden.
- **WARNUNG:** Vergewissern Sie sich, dass das Gerät ausgeschaltet ist, bevor Sie die Lampe austauschen, um einen Stromschlag zu vermeiden.
- **ACHTUNG:** Das Gerät und die zugänglichen Geräteteile werden während des Betriebs heiß. Es ist darauf zu achten, die Heizelemente oder die Oberfläche des Garraums nicht zu berühren.
- Verwenden Sie stets Topfhandschuhe, um Zubehör oder Geschirr herauszunehmen oder zu verstauen.
- Ziehen Sie die Einhängegitter zuerst vorne und dann hinten von den Seitenwänden weg. Setzen Sie die Einhängegitter in umgekehrter Reihenfolge ein.
- Reinigen Sie das Gerät nicht mit einem Dampfstrahlreiniger.
- Benutzen Sie zum Reinigen der Glastür keine scharfen Scheuermittel oder Metallschwämmchen; sie könnten die

Glasfläche verkratzen und zum Zersplittern der Scheibe führen.

2. SICHERHEITSANWEISUNGEN

2.1 Montage

⚠️ WARNUNG!
Die Montage des Geräts darf nur von einer qualifizierten Fachkraft durchgeführt werden.

- Entfernen Sie das gesamte Verpackungsmaterial.
- Montieren Sie ein beschädigtes Gerät nicht und benutzen Sie es nicht.
- Halten Sie sich an die mitgelieferte Montageanleitung.
- Seien Sie beim Umsetzen des Gerätes vorsichtig, da es sehr schwer ist. Tragen Sie stets Sicherheitshandschuhe und festes Schuhwerk.
- Ziehen Sie das Gerät nicht am Griff.
- Montieren Sie das Gerät an einem sicheren und geeigneten Ort, der den Montageanforderungen entspricht.
- Die Mindestabstände zu anderen Geräten und Küchenmöbeln sind einzuhalten.
- Überprüfen Sie vor der Montage des Gerätes, ob sich die Gerätetür ungehindert öffnen lässt.
- Das Gerät ist mit einem elektrischen Kühlsystem ausgestattet. Es muss mit der elektrischen Stromversorgung betrieben werden.
- Das Einbaugerät muss die Stabilitätsanforderungen von DIN 68930 erfüllen.

Mindesthöhe des Einbaumöbels (Mindesthöhe des Schrankes unter der Arbeitsplatte)	578 (600) mm
Schrankbreite	560 mm
Schranktiefe	550 (550) mm
Höhe der Gerätevorderseite	594 mm
Höhe der Geräterückseite	576 mm

Breite der Gerätevorderseite	595 mm
Breite der Geräterückseite	559 mm
Gerätetiefe	567 mm
Geräteeinbautiefe	546 mm
Tiefe bei geöffneter Tür	1027 mm
Mindestgröße der Belüftungsöffnung. Öffnung auf der Rückseite unten	560x20 mm
Länge des Netzanschlusskabels. Das Kabel befindet sich in der rechten Ecke auf der Rückseite	1500 mm
Befestigungsschrauben	4x25 mm

2.2 Elektrischer Anschluss

⚠️ WARNUNG!
Brand- und Stromschlaggefahr.

- Alle elektrischen Anschlüsse sind von einem geprüften Elektriker vorzunehmen.
- Das Gerät muss geerdet sein.
- Stellen Sie sicher, dass die Daten auf dem Typenschild mit den elektrischen Nennwerten der Netzspannung übereinstimmen.
- Schließen Sie das Gerät nur an eine ordnungsgemäß installierte Schutzkontaktsteckdose an.
- Verwenden Sie keine Mehrfachsteckdosen oder Verlängerungskabel.
- Achten Sie darauf, Netzstecker und Netzkabel nicht zu beschädigen. Falls das Netzkabel des Geräts ersetzt werden muss, lassen Sie diese Arbeit durch unseren autorisierten Kundendienst durchführen.
- Achten Sie darauf, dass das Netzkabel die Gerätetür oder die Nische unter dem Gerät nicht berührt oder in ihre Nähe

gelangt, insbesondere wenn das Gerät eingeschaltet oder die Tür heiß ist.

- Alle Teile, die gegen direktes Berühren schützen, sowie die isolierten Teile müssen so befestigt werden, dass sie nicht ohne Werkzeug entfernt werden können.
- Stecken Sie den Netzstecker erst nach Abschluss der Montage in die Steckdose. Stellen Sie sicher, dass der Netzstecker nach der Montage noch zugänglich ist.
- Falls die Steckdose lose ist, schließen Sie den Netzstecker nicht an.
- Ziehen Sie nicht am Netzkabel, wenn Sie das Gerät von der Stromversorgung trennen möchten. Ziehen Sie stets am Netzstecker.
- Verwenden Sie nur geeignete Trenneinrichtungen: Überlastschalter, Sicherungen (Schraubsicherungen müssen aus dem Halter entfernt werden können), Fehlerstromschutzschalter und Schütze.
- Die elektrische Installation muss eine Trenneinrichtung aufweisen, mit der Sie das Gerät allpolig von der Stromversorgung trennen können. Die Trenneinrichtung muss mit einer Kontaktöffnungsweite von mindestens 3 mm ausgeführt sein.
- Das Gerät wird mit einem Netzstecker und Netzkabel geliefert.

2.3 Gebrauch

WARNUNG!

Verletzungs-, Verbrennungs-, Stromschlag- oder Explosionsgefahr.

- Nehmen Sie keine technischen Änderungen am Gerät vor.
- Vergewissern Sie sich, dass die Lüftungsöffnungen nicht blockiert sind.
- Lassen Sie das Gerät während des Betriebs nicht unbeaufsichtigt.
- Schalten Sie das Gerät nach jedem Gebrauch aus.
- Gehen Sie beim Öffnen der Tür vorsichtig vor, wenn das Gerät in Betrieb ist. Es kann heiße Luft freigesetzt werden.
- Benutzen Sie das Gerät nicht mit nassen Händen oder wenn es mit Wasser Kontakt hat.

- Üben Sie keinen Druck auf die offene Tür aus.
- Verwenden Sie das Gerät nicht als Arbeits- oder Abstellfläche.
- Öffnen Sie die Gerätetür vorsichtig. Die Verwendung von Zutaten mit Alkohol kann eine Mischung aus Alkohol und Luft verursachen.
- Lassen Sie beim Öffnen der Tür keine Funken oder offenen Flammen mit dem Gerät in Kontakt kommen.
- Platzieren Sie keine entflammaren Produkte oder Gegenstände, die mit entflammaren Produkten benetzt sind, im Gerät, auf dem Gerät oder in der Nähe des Geräts.

WARNUNG!

Risiko von Schäden am Gerät.

- Um Beschädigungen und Verfärbungen der Emailbeschichtung zu vermeiden:
 - Stellen Sie feuerfestes Geschirr oder andere Gegenstände nicht direkt auf den Boden des Geräts.
 - Legen Sie keine Alufolie direkt auf den Boden des Garraums.
 - Füllen Sie kein Wasser direkt in das heiße Gerät.
 - Lassen Sie nach Abschluss des Garvorgangs kein feuchtes Geschirr oder feuchte Speisen im Gerät stehen.
 - Gehen Sie beim Herausnehmen oder Einsetzen des Zubehörs sorgfältig vor.
- Verfärbungen der Emaille- oder Edelstahlbeschichtung haben keine Auswirkung auf die Leistung des Geräts.
- Verwenden Sie eine tiefe Pfanne für feuchte Kuchen. Fruchtsäfte verursachen Flecken, die dauerhaft sein können.
- Kochen Sie immer bei geschlossener Gerätetür.
- Ist das Gerät hinter einer Möbelfront (wie etwa einer Tür) installiert, achten Sie darauf, dass die Tür während des Gerätebetriebs nicht geschlossen wird. Hinter einer geschlossenen Möbelfront können sich Hitze und Feuchtigkeit ansammeln und das Gerät, das Gehäuse oder den Boden beschädigen. Schließen Sie die Möbelfront nicht, bevor das Gerät nach dem Gebrauch völlig abgekühlt ist.

2.4 Reinigung und Pflege

WARNUNG!

Verletzungs-, Brandgefahr sowie Risiko von Schäden am Gerät.

- Schalten Sie das Gerät immer aus und ziehen Sie den Netzstecker aus der Steckdose, bevor Reinigungsarbeiten durchgeführt werden.
- Vergewissern Sie sich, dass das Gerät abgekühlt ist. Es besteht die Gefahr, dass die Glasscheiben brechen.
- Ersetzen Sie die Türglasscheiben umgehend, wenn sie beschädigt sind. Wenden Sie sich an einen autorisierten Kundendienst.
- Gehen Sie beim Aushängen der Tür vorsichtig vor. Die Tür ist schwer!
- Reinigen Sie das Gerät regelmäßig, um eine Verschlechterung des Oberflächenmaterials zu verhindern.
- Reinigen Sie das Gerats mit einem weichen, feuchten Tuch. Verwenden Sie ausschließlich Neutralreiniger. Benutzen Sie keine Scheuermittel, scheuernde Reinigungsschwammchen, Losungsmittel oder Metallgegenstande.
- Falls Sie ein Backofenspray verwenden, befolgen Sie die Sicherheitsanweisungen auf seiner Verpackung.

2.5 Innenbeleuchtung

WARNUNG!

Stromschlaggefahr.

- Bezuglich der Lampe(n) in diesem Gerat und separat verkaufter Ersatzlampen: Diese Lampen mussen extremen physikalischen Bedingungen in Haushaltsgeraten standhalten, wie z.B. Temperatur, Vibration, Feuchtigkeit, oder sollen Informationen uber den Betriebszustand des Gerates anzeigen. Sie sind nicht fur den Einsatz in anderen Geraten vorgesehen und nicht fur die Raumbelichtung geeignet.
- Dieses Produkt enthalt eine Lichtquelle der Energieeffizienzklasse G.
- Verwenden Sie nur Lampen mit der gleichen Leistung .

2.6 Wartung

- Wenden Sie sich zur Reparatur des Gerats an den autorisierten Kundendienst.
- Dabei durfen ausschlielich Originalersatzteile verwendet werden.

2.7 Entsorgung

WARNUNG!

Verletzungs- und Erstickungsgefahr.

- Informationen zur Entsorgung des Gerats erhalten Sie von Ihrer Gemeindeverwaltung.
- Trennen Sie das Gerat von der Stromversorgung.
- Schneiden Sie das Netzkabel in der Nahe des Gerats ab, und entsorgen Sie es.
- Entfernen Sie das Turschloss, um zu verhindern, dass sich Kinder, oder Haustiere im Gerat einschlieen.

3. GERÄTEBESCHREIBUNG

3.1 Gesamtansicht

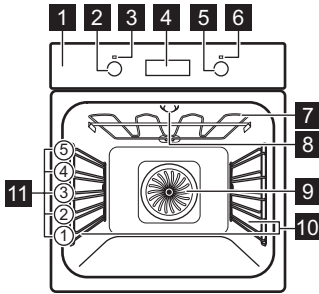

- 1 Bedienfeld
- 2 Einstellknopf für die Ofenfunktionen
- 3 Betriebskontrolllampe/-symbol
- 4 Display
- 5 Einstellknopf (für die Temperatur)
- 6 Temperaturanzeige / -symbol
- 7 Heizelement
- 8 Lampe
- 9 Ventilator
- 10 Einschubschienen, herausnehmbar
- 11 Einschubebenen

3.2 Zubehör

Kombirost

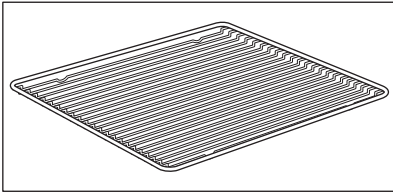

Für Kochgeschirr, Kuchenformen, Braten.

Backblech

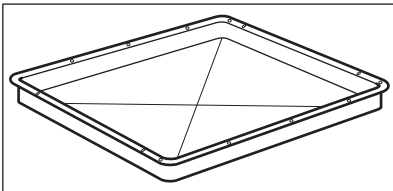

Für Kuchen und Plätzchen.

Brat- und Fettpfanne

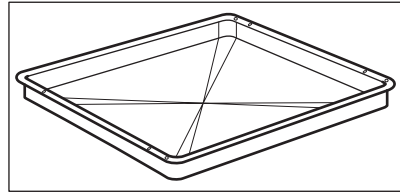

Zum Backen und Braten oder zum Auffangen von abtropfendem Fett.

4. BEDIENFELD

4.1 Versenkbare Knöpfe

Drücken Sie zum Benutzen des Geräts den Knopf. Der Knopf kommt dann heraus.

4.2 Sensorfelder/Tasten

—	Einstellen der Zeit.
	Einstellen einer Uhrfunktion.
+	Einstellen der Zeit.

4.3 Display

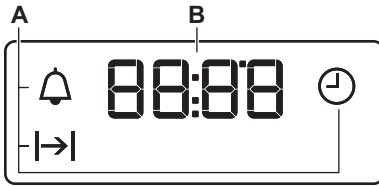

- A. Uhrfunktionen
- B. Timer







5. VOR DER ERSTEN INBETRIEBNAHME

WARNUNG!

Siehe Kapitel Sicherheitshinweise.

5.1 Vor der ersten Inbetriebnahme

Der Backofen kann während des Aufheizens Geruch und Rauch verströmen. Stellen Sie sicher, dass der Raum belüftet ist.

 Schritt 1	 Schritt 2	 Schritt 3
Stellen Sie die Uhrzeit ein.	Reinigen Sie den Backofen.	Heizen Sie den leeren Backofen vor.
1.  - zum Einstellen der Zeit drücken. Nach etwa 5 Sek. hört die Anzeige auf zu blinken und das Display zeigt die Zeit an.	1. Entfernen Sie alle Zubehörteile und die herausnehmbaren Einhängegitter aus dem Backofen. 2. Reinigen Sie das Gerät und das Zubehör nur mit einem Mikrofasertuch, warmem Wasser und einem milden Reinigungsmittel.	1. Stellen Sie die Höchsttemperatur für folgende Funktion ein:  Zeit: 1 Std. 2. Stellen Sie die Höchsttemperatur für folgende Funktion ein:  Zeit: 15 Min.

Schalten Sie den Backofen aus und warten Sie, bis er abgekühlt ist. Setzen Sie die Zubehörteile und die herausnehmbaren Einhängegitter in den Backofen ein.

6. TÄGLICHER GEBRAUCH

WARNUNG!

Siehe Kapitel Sicherheitshinweise.







6.1 Einstellung: Ofenfunktion

Schritt 1 Drehen Sie den Backofen-Einstellknopf auf eine Ofenfunktion.

Schritt 2 Drehen Sie den Wahlknopf, um die Temperatur auszuwählen.

Schritt 3 Drehen Sie nach Beendigung des Garvorgangs die Knöpfe in die Aus-Position, um den Backofen auszuschalten.

6.2 Ofenfunktionen

Ofenfunktion	Gerät
	Der Backofen ist ausgeschaltet.
Aus-Position	
	Zum Einschalten der Lampe.
Backofenbeleuchtung	
	Zum Backen auf bis zu drei Einschubebenen gleichzeitig und zum Dörren von Lebensmitteln. Verwenden Sie eine um 20 - 40 °C niedrigere Backofentemperatur als bei Ober- / Unterhitze.
Heißluft	
	Zum Backen von Pizza. Für ein intensives Überbacken und einen knusprigen Boden.
Pizzastufe	
	Backen und Braten von Speisen auf einer Einschubebene.
Ober- / Unterhitze	
	Zum Backen von Kuchen mit knusprigen Böden und zum Einkochen von Lebensmitteln.
Unterhitze	

Ofenfunktion

Gerät



Auftauen

Zum Auftauen von Lebensmitteln (Gemüse und Obst). Die Auftauzeit hängt von der Menge und Größe der gefrorenen Lebensmittel ab.



Feuchte Umluft

Diese Funktion ist entwickelt worden, um während des Kochvorgangs Energie zu sparen. Wenn Sie diese Funktion nutzen, kann die Temperatur im Garraum von der eingestellten Temperatur abweichen. Es wird die Restwärme genutzt. Die Wärmeleistung kann geringer sein. Weitere Informationen zu folgenden Themen finden Sie im Kapitel „Täglicher Gebrauch“: Feuchte Umluft.



Grill

Zum Grillen dünner Lebensmittel und zum Toasten von Brot.



Heißluftgrillen

Zum Braten großer Fleischstücke oder von Geflügel mit Knochen auf einer Ebene. Gratieren und Überbacken.



Die Lampe wird bei einigen Ofenfunktionen und einer Temperatur unter 60 °C automatisch ausgeschaltet.

6.3 Hinweise zum: Feuchte Umluft

Diese Funktion wurde zur Einhaltung der Energieeffizienzklassen- und Umweltdesignanforderungen (gemäß EU 65/2014 und EU 66/2014) verwendet. Tests gemäß: IEC/EN 60350-1.



Die Backofentür sollte während des Garvorgangs geschlossen bleiben, damit die Funktion nicht unterbrochen wird. So wird gewährleistet, dass der Backofen mit der höchsten Energieeffizienz arbeitet.

Kochanweisungen finden Sie im Kapitel „Tipps und Hinweise“, Feuchte Umluft. Allgemeine Empfehlungen zum

Energiesparen finden Sie im Kapitel „Energieeffizienz“, Energiesparen.

7. UHRFUNKTIONEN



7.1 Uhrfunktionen

Uhrfunktion	Anwendung
 Uhrzeit	Zum Einstellen, Ändern oder Abfragen der Uhrzeit.
 Dauer	Einstellen der Einschaltdauer für den Backofen.
 Kurzzeit-Wecker	Zum Einstellen eines Countdowns. Diese Funktion wirkt sich nicht auf den Betrieb des Backofens aus. Sie können diese Funktion jederzeit und auch bei ausgeschaltetem Backofen einstellen.

7.2 Einstellung: Uhrfunktionen



Einstellung: Uhrzeit

 blinkt, wenn Sie den Backofen an die Stromversorgung anschließen, nach einem Stromausfall und wenn der Timer nicht eingestellt ist.

 ,  – zum Einstellen der Zeit drücken.
Nach etwa 5 Sek. hört die Anzeige auf zu blinken, und das Display zeigt die Zeit an.

Änderung: Uhrzeit





Schritt 1  – wiederholt drücken, um die Tageszeit zu ändern.  – beginnt zu blinken.

Schritt 2  ,  – zum Einstellen der Zeit drücken.
Nach etwa 5 Sek. hört die Anzeige auf zu blinken, und das Display zeigt die Zeit an.

Einstellung: Dauer

Schritt 1 Stellen Sie eine Ofenfunktion und die Temperatur ein.



Schritt 2  – wiederholt drücken.  – beginnt zu blinken.



Schritt 3  ,  – zum Einstellen der Dauer drücken.
Im Display wird Folgendes angezeigt: .
 – blinkt, wenn die eingestellte Zeit abgelaufen ist. Der Signalton ertönt, und der Backofen wird ausgeschaltet.

Schritt 4 Drücken Sie eine beliebige Taste, um das Signal abzustellen.

Schritt 5 Drehen Sie den Knopf in die Aus-Position.

Einstellung: Kurzzeit-Wecker

Schritt 1  – wiederholt drücken.  – beginnt zu blinken.

Schritt 2 ,  – zum Einstellen der Zeit drücken.
Die Funktion startet automatisch nach 5 Sekunden.
Nach Ablauf der eingestellten Zeit ertönt der Signalton.

Schritt 3 Drücken Sie eine beliebige Taste, um das Signal abzustellen.

Schritt 4 Drehen Sie den Knopf in die Aus-Position.

Abbrechen: Uhrfunktionen

Schritt 1  – wiederholt drücken, bis das Symbol der Uhrfunktion zu blinken anfängt.

Schritt 2 Drücken und halten Sie: .
Die Uhrfunktion wird nach einigen Sekunden ausgeschaltet.

8. VERWENDUNG DES ZUBEHÖRS

WARNUNG!

Siehe Kapitel Sicherheitshinweise.

8.1 Einsetzen des Zubehörs

Die kleine Einkerbung auf der Oberseite erhöht die Sicherheit. Die Vertiefungen sind

auch Kippsicherungen. Durch den umlaufend erhöhten Rand des Rosts ist das Kochgeschirr gegen Abrutschen vom Rost gesichert.

Kombirost:

Schieben Sie den Rost zwischen die Führungsschienen der Einhängegitter.

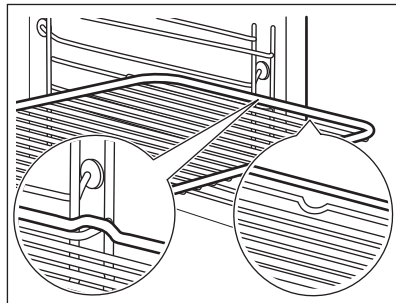

Backblech / Auflauffanne:

Schieben Sie das Backblech zwischen die Führungsstäbe der Einhängegitter.

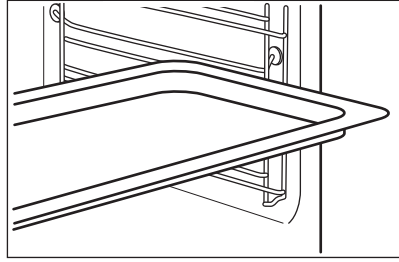

9. ZUSATZFUNKTIONEN

9.1 Kühlgebläse

Wenn das Gerät in Betrieb ist, schaltet sich das Kühlgebläse automatisch ein, um die Oberflächen des Geräts kühl zu halten. Nach

dem Abschalten des Geräts kann das Kühlgebläse weiterlaufen, bis das Gerät abgekühlt ist.

10. TIPPS UND HINWEISE



Siehe Kapitel Sicherheitshinweise.

10.1 Garempfehlungen



Die Temperaturen und Garzeiten in den Tabellen sind nur Richtwerte. Sie hängen von den Rezepten sowie der Qualität und Menge der verwendeten Zutaten ab. Ihr Gerät backt oder brät unter Umständen anders als Ihr früheres Gerät. Die Hinweise unten enthalten die empfohlenen Einstellungen für Temperatur, Gardauer und Einschubebene für die einzelnen Speisen. Finden Sie für ein bestimmtes Rezept keine konkreten Angaben, orientieren Sie sich an einem ähnlichem Rezept.

10.2 Backen

Nutzen Sie, wenn Sie zum ersten Mal backen, die niedrigere Temperatur.

Sie können die Backzeit um 10 - 15 Minuten verlängern, wenn Kuchen auf mehreren Ebenen gebacken werden.

Höhenunterschiede bei Kuchen und Gebäck können zu unterschiedlicher Bräunung





führen. Im Fall einer unterschiedlichen Bräunung ist es nicht notwendig die Temperatur zu ändern. Die Unterschiede gleichen sich während des Backens aus.

Die Backbleche im Ofen können sich beim Backen verformen. Nachdem die Backbleche abgekühlt sind, hebt sich die Verformung wieder auf.

10.3 Backtipps

Backergebnis	Mögliche Ursache	Abhilfe
Die Unterseite des Kuchens ist nicht ausreichend gebacken.	Die Einschubebene ist nicht richtig.	Stellen Sie den Kuchen auf eine tiefere Einschubebene.
Der Kuchen fällt zusammen und ist noch teigig oder mit Wasserstreifen durchzogen.	Die Backofentemperatur ist zu hoch.	Stellen Sie beim nächsten Mal eine niedrigere Backofentemperatur ein.
	Die Backofentemperatur ist zu hoch und die Backzeit zu kurz.	Stellen Sie beim nächsten Mal eine längere Backzeit und eine niedrigere Backofentemperatur ein.
Der Kuchen ist zu trocken.	Die Backofentemperatur ist zu niedrig.	Stellen Sie beim nächsten Mal eine höhere Backofentemperatur ein.
	Die Backzeit ist zu lang.	Stellen Sie beim nächsten Mal eine kürzere Backzeit ein.
Der Kuchen ist unregelmäßig gebräunt.	Die Backofentemperatur ist zu hoch und die Backzeit zu kurz.	Stellen Sie beim nächsten Mal eine längere Backzeit und eine niedrigere Backofentemperatur ein.
	Der Kuchenteig ist nicht gleichmäßig verteilt.	Verteilen Sie beim nächsten Mal den Kuchenteig gleichmäßiger auf dem Backblech.
Der Kuchen ist nach der im Rezept angegebenen Backzeit nicht fertig gebacken.	Die Backofentemperatur ist zu niedrig.	Stellen Sie beim nächsten Mal eine etwas höhere Backofentemperatur ein.



10.4 Backen auf einer Einschubebene

 BACKEN IN FORMEN		 (°C)	 (Min.)	
Tortenboden aus Mürbeteig, Heizen Sie den leeren Backofen vor.	Heißluft	170 - 180	10 - 25	2
Tortenboden aus Rührteig	Heißluft	150 - 170	20 - 25	2
Gugelhupf / Bröckchen	Heißluft	150 - 160	50 - 70	1
Sandkuchen / Früchtekuchen	Heißluft	140 - 160	70 - 90	1
Käsekuchen	Ober- / Unterhitze	170 - 190	60 - 90	1

Nutzen Sie die dritte Einschubebene.

Verwenden Sie die Funktion Heißluft.





Verwenden Sie ein Backblech.

 KUCHEN/GEBÄCK/BROTE	 (°C)	 (Min.)
Streuselkuchen	150 - 160	20 - 40
Obstkuchen (mit Hefeteig / Rührteig), verwenden Sie ein tiefes Blech	150	35 - 55
Obstkuchen mit Mürbeteig	160 - 170	40 - 80





Leeren Backofen vorheizen.





Verwenden Sie die Funktion Ober- / Unterhitze.

Verwenden Sie ein Backblech.

 KUCHEN/ GEBÄCK/BROTE	 (°C)	 (Min.)	
Biskuitrolle	180 - 200	10 - 20	3
Roggenbrot:	erst: 230 anschließend: 160 - 180	20 30 - 60	1
Mandelkuchen mit Butter / Zuckerkuchen	190 - 210	20 - 30	3
Windbeutel / Blätterteig	190 - 210	20 - 35	3
Hefezopf / Hefekranz	170 - 190	30 - 40	3
Obstkuchen (mit Hefeteig / Rührteig), verwenden Sie ein tiefes Blech	170	35 - 55	3
Hefekuchen mit delikatem Belag (z. B. Quark, Sahne, Pudding)	160 - 180	40 - 80	3
Christstollen	160 - 180	50 - 70	2





Nutzen Sie die dritte Einschubebene.

 KLEINGEBÄCK		 (°C)	 (Min.)
Mürbeteigplätzchen	Heißluft	150 - 160	10 - 20
Brötchen, Heizen Sie den lee- ren Backofen vor.	Heißluft	160	10 - 25
Rührteigplätzchen	Heißluft	150 - 160	15 - 20
Blätterteiggebäck, Heizen Sie den leeren Backofen vor.	Heißluft	170 - 180	20 - 30

 KLEINGEBÄCK		 (°C)	 (Min.)
Hefekleingebäck	Heißluft	150 - 160	20 - 40
Makronen	Heißluft	100 - 120	30 - 50
Kleingebäck aus Eiweiß / Baiser	Heißluft	80 - 100	120 - 150
Brötchen, Heizen Sie den leeren Backofen vor.	Ober- / Unterhitze	190 - 210	10 - 25

10.5 Aufläufe und Gratins





Nutzen Sie die erste Einschubebene.





		 (°C)	 (Min.)
Baguettes belegt mit geschmolzenem Käse	Heißluft	160 - 170	15 - 30
Gemüse, überbacken, Heizen Sie den leeren Backofen vor.	Heißluftgrillen	160 - 170	15 - 30
Lasagne, frisch	Ober- / Unterhitze	180 - 200	25 - 40
Fischaufläufe	Ober- / Unterhitze	180 - 200	30 - 60
Gefülltes Gemüse	Heißluft	160 - 170	30 - 60
Süße Aufläufe	Ober- / Unterhitze	180 - 200	40 - 60
Nudelaufwurf	Ober- / Unterhitze	180 - 200	45 - 60

10.6 Backen auf mehreren Ebenen

Verwenden Sie die Funktion Heißluft.

Benutzen Sie die Backbleche.

 KUCHEN/ GEBÄCK	 (°C)	 (Min.)	 2 Ebenen
Windbeutel / Blätterteig, Heizen Sie den leeren Backofen vor.	160 - 180	25 - 45	1 / 4
Streuselkuchen trocknen	150 - 160	30 - 45	1 / 4

 KLEIN- GEBÄCK/KLEI- NE KUCHEN/ GEBÄCK/BRÖT- CHEN	 (°C)	 (Min.)		
			2 Ebenen	3 Ebenen
Brötchen	180	20 - 30	1 / 4	-
Mürbeteigplätzchen	150 - 160	20 - 40	1 / 4	1 / 3 / 5
Rührteigplätzchen	160 - 170	25 - 40	1 / 4	-
Blätterteiggebäck, Heizen Sie den lee- ren Backofen vor.	170 - 180	30 - 50	1 / 4	-
Hefekleingebäck	160 - 170	30 - 60	1 / 4	-
Makronen	100 - 120	40 - 80	1 / 4	-
Gebäck aus Eiweiß / Baiser	80 - 100	130 - 170	1 / 4	-

10.7 Tipps zum Braten

Verwenden Sie hitzefestes Geschirr.

Braten Sie mageres Fleisch abgedeckt (Sie können Aluminiumfolie verwenden).

Große Fleischstücke direkt auf dem Backblech braten.

Geben Sie etwas Wasser ins Blech, um zu verhindern, dass das herabtropfende Fett brennt.

Drehen Sie den Braten nach 1/2 - 2/3 der Gardauer.





Fleisch und Fisch in großen Stücken (1 kg oder mehr) braten.

Wenn Ebene 1 empfohlen ist, legen Sie die Speisen direkt auf das Backblech

Beträufeln Sie die Fleischkeulen während des Bratens mehrere Male mit dem eigenen Saft.

10.8 Braten

Nutzen Sie die erste Einschubebene.

 RINDFLEISCH				
			(°C)	(Min.)
Schmorfleisch	1 - 1,5 kg	Ober- / Unterhitze	230	120 - 150
Roastbeef oder Filet, blu- tig, Heizen Sie den lee- ren Backofen vor.	je cm Dicke	Heißluftgrillen	190 - 200	5 - 6
Roastbeef oder Filet, ro- sa, Heizen Sie den lee- ren Backofen vor.	je cm Dicke	Heißluftgrillen	180 - 190	6 - 8



RINDFLEISCH



(°C)



(Min.)

Roastbeef oder Filet,
durch, Heizen Sie den
leeren Backofen vor.

je cm Dicke

Heißluftgrillen

170 - 180

8 - 10



SCHWEINEFLEISCH



Verwenden Sie die Funktion Heißluftgrillen.



(kg)



(°C)



(Min.)

Schulter / Nacken / Schinken-
stück

1 - 1.5

160 - 180

90 - 120

Koteletts / Rippchen

1 - 1.5

170 - 180

60 - 90

Hackbraten

0.75 - 1

160 - 170

50 - 60

Schweinshaxe, vorgegart

0.75 - 1

150 - 170

90 - 120



KALB



Verwenden Sie die Funktion Heißluftgrillen.



(kg)



(°C)



(Min.)

Kalbsbraten

1

160 - 180

90 - 120

Kalbshaxe

1.5 - 2

160 - 180

120 - 150



LAMM



Verwenden Sie die Funktion Heißluftgrillen.



(kg)



(°C)



(Min.)

Lammkeule / Lamnbraten

1 - 1.5

150 - 170

100 - 120

Lammrücken

1 - 1.5

160 - 180

40 - 60



WILD



Verwenden Sie die Funktion Ober- / Unterhitze.



(kg)



(°C)



(Min.)

Rücken / Hasenkeule, Heizen Sie den leeren Backofen vor.

bis zu 1

230

30 - 40

Reh- / Hirschrücken

1.5 - 2

210 - 220

35 - 40

Reh- / Hirschkeule

1.5 - 2

180 - 200

60 - 90



GEFLÜGEL



Verwenden Sie die Funktion Heißluftgrillen.



(kg)



(°C)



(Min.)

Geflügelteile

je 0,2 - 0,25

200 - 220

30 - 50

Hähnchen, halbiert

je 0,4 - 0,5

190 - 210

35 - 50

Hähnchen, Poularde

1 - 1.5

190 - 210

50 - 70

Ente

1.5 - 2

180 - 200

80 - 100

Gans

3.5 - 5

160 - 180

120 - 180

Pute

2.5 - 3.5

160 - 180

120 - 150

Pute

4 - 6

140 - 160

150 - 240



FISCH, GEDÄMPFT



Verwenden Sie die Funktion Ober- / Unterhitze.



(kg)



(°C)



(Min.)

Fisch, ganz

1 - 1.5

210 - 220

40 - 60

10.9 Knusprige Backwaren mit Pizzastufe



PIZZA



Nutzen Sie die erste Einschubebene.



(°C)



(Min.)

Linzertorte / Tarte

180 - 200 40 - 55

Spinat-Flan

160 - 180 45 - 60

Quiche Lorraine / Schweizer Flan

170 - 190 45 - 55

Käsekuchen

140 - 160 60 - 90

Gemüsekuchen

160 - 180 50 - 60



PIZZA



Heizen Sie den leeren Backofen vor dem Garen vor.



Nutzen Sie die zweite Einschubebene.



(°C)



(Min.)

Pizza, dünner

200 - 230

15 - 20

Boden, verwenden Sie ein tiefes Blech



PIZZA



Heizen Sie den leeren Backofen vor dem Garen vor.



Nutzen Sie die zweite Einschubebene.



(°C)



(Min.)

Pizza, dicker Boden

180 - 200

20 - 30

Fladenbrot

230 - 250

10 - 20

Blätterteigkuchen

160 - 180

45 - 55

Flammkuchen

230 - 250

12 - 20

Piroggen

180 - 200

15 - 25

10.10 Grill

Heizen Sie den leeren Backofen vor dem Garen vor.

Grillen Sie nur dünne Fleisch- oder Fischstücke.

Setzen Sie ein Kuchenblech in die erste Einschubebene, um das Fett aufzufangen.



GRILL



Verwenden Sie die Funktion: Grill



(°C)



(Min.)
Erste Seite



(Min.)
Zweite Seite



	(°C)	(Min.) Erste Seite	(Min.) Zweite Seite	
Roastbeef	210 - 230	30 - 40	30 - 40	2
Rinderfilet	230	20 - 30	20 - 30	3
Schweinelende	210 - 230	30 - 40	30 - 40	2
Kalbsrücken	210 - 230	30 - 40	30 - 40	2
Lammrücken	210 - 230	25 - 35	20 - 25	3
Fisch, ganz 0,5 kg - 1 kg	210 - 230	15 - 30	15 - 30	3 / 4

10.11 Tiefkühlgerichte



AUFTAUEN



Verwenden Sie die Funktion: Heißluft.



(°C)



(Min.)



	(°C)	(Min.)	
Pizza, gefroren	200 - 220	15 - 25	2
Pizza American, gefroren	190 - 210	20 - 25	2
Pizza, gekühlt	210 - 230	13 - 25	2
Pizza-Snacks, gefroren	180 - 200	15 - 30	2
Pommes frites, dünn	200 - 220	20 - 30	3
Pommes frites, dick	200 - 220	25 - 35	3
Kartoffelspalten / Kroketten	220 - 230	20 - 35	3
Rösti	210 - 230	20 - 30	3
Lasagne, frisch / Cannelloni, frisch	170 - 190	35 - 45	2
Lasagne, frisch / Cannelloni, gefroren	160 - 180	40 - 60	2



AUFTAUEN



Verwenden Sie die Funktion: Heißluft.



(°C)



(Min.)



Gebackener Käse	170 - 190	20 - 30	3
Hähnchenflügel	190 - 210	20 - 30	2

10.12 Auftauen

Nehmen Sie die Lebensmittel aus der Verpackung und legen Sie sie auf einen Teller.

Bedecken Sie die Speise nicht, da dies die Auftauzeit verlängern kann.

Legen Sie bei größeren Nahrungsmittelportionen einen leeren

Nutzen Sie die erste Einschubebene.

umgedrehten Teller auf den Garraumboden. Legen Sie die Speise in eine tiefe Schüssel und stellen Sie sie auf den Teller im Backofen. Entfernen Sie bei Bedarf die Einhängegitter.



(kg)



(Min.)
Auftauzeit



(Min.)
Zusätzliche Auf-
tauzeit



Hähnchen	1	100 – 140	20 – 30	Nach der Hälfte der Gardauer wenden.
Fleisch	1	100 – 140	20 – 30	Nach der Hälfte der Gardauer wenden.
Forelle	0,15	25 – 35	10 – 15	–
Erdbeeren	0,3	30 – 40	10 – 20	–
Butter	0,25	30 – 40	10 – 15	–
Sahne	2 x 0,2	80 – 100	10 – 15	Sahne im leicht gefrorenen Zustand aufschlagen.
Torte	1,4	60	60	–

10.13 Einkochen

Verwenden Sie die Funktion Unterhitze.

Verwenden Sie nur handelsübliche Einkochgläser mit denselben Abmessungen.

Verwenden Sie keine Einmachgläser mit Schraub- und Bajonettdeckeln oder Metall Dosen.

Nutzen Sie die erste Einschubebene.

Stellen Sie nicht mehr als sechs Ein-Liter-Einmachgläser auf das Backblech.



Füllen Sie die Einmachgläser gleichmäßig und verschließen Sie sie mit einer Klammer.



Die Einmachgläser dürfen sich nicht berühren.



Geben Sie ungefähr 0,5 l Wasser ins Backblech, um ausreichend Feuchtigkeit im Backofen sicherzustellen.



Wenn die Flüssigkeit in den Einmachgläsern zu köcheln beginnt (nach ungefähr 35-60 Minuten bei 1-l-Einmachgläsern), schalten Sie den Backofen aus oder reduzieren Sie die Temperatur auf 100 °C (siehe Tabelle).

Stellen Sie die Temperatur auf 160 - 170 °C ein.

	BEERENOBST	
		(Min.) Gardauer bis zum Köcheln
Erdbeeren / Blaubeeren / Himbeeren / Reife Stachelbeeren	35 - 45	

	STEIN-OBST		
		(Min.) Gardauer bis zum Köcheln	(Min.) Kochen Sie weiter bei 100 °C
Pfirsiche / Quit-ten / Pflaumen	35 - 45	10 - 15	

	GE-MÜSE		
		(Min.) Gardauer bis zum Köcheln	(Min.) Kochen Sie weiter bei 100 °C
Karotten	50 - 60	5 - 10	
Gurken	50 - 60	-	
Mixed Pickles	50 - 60	5 - 10	

	GE-MÜSE		
		(Min.) Gardauer bis zum Köcheln	(Min.) Kochen Sie weiter bei 100 °C
Kohlrabi / Erbsen / Spargel	50 - 60	15 - 20	



10.14 Dörren - Heißluft

Bleche mit fettbeständigem Papier oder Backpapier abdecken.



Um ein besseres Ergebnis zu erzielen, schalten Sie den Backofen nach der Hälfte der Trockenzeit aus, öffnen Sie die Tür und lassen Sie ihn eine Nacht abkühlen, um das Trocknen abzuschließen.

Nutzen Sie für 1 Blech die dritte Einschubebene.

Für 2 Bleche verwenden Sie die erste und vierte Einschubebene.



	GEMÜSE		
		(°C)	(Std.)
Bohnen	60 - 70	6 - 8	
Paprika	60 - 70	5 - 6	
Suppengemüse	60 - 70	5 - 6	
Pilze	50 - 60	6 - 8	
Kräuter	40 - 50	2 - 3	

Stellen Sie die Temperatur auf 60 - 70 °C ein.

	OBST	
		(Std.)
Pflaumen	8 - 10	
Aprikosen	8 - 10	
Apfelscheiben	6 - 8	
Birnen	6 - 9	



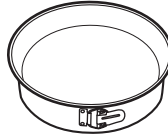

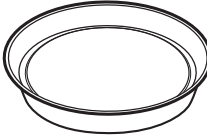
10.15 Feuchte Umluft - Empfohlenes Zubehör

Verwenden Sie die dunklen und nicht reflektierenden Formen und Behälter. Sie haben eine bessere Wärmeabsorption als helle Farbe und reflektierende Schüsseln.

			
Pizzapfanne	Backform	Förmchen	Tortenbodenform
Dunkel, nicht reflektierend 28 cm Durchmesser	Dunkel, nicht reflektierend 26 cm Durchmesser	Keramikform 8 cm Durchmesser, 5 cm Höhe	Dunkel, nicht reflektierend 28 cm Durchmesser

10.16 Feuchte Umluft





Beachten Sie für beste Ergebnisse die unten in der Tabelle aufgeführten Empfehlungen.





	 (°C)	 (Min.)	
Grissini, 0,5 kg insgesamt	190 - 200	50 - 60	3
Jakobsmuscheln in Schale gebacken	180 - 200	30 - 40	4
Fisch, ganz in Salzkruste, 0,3 - 0,5 kg	190 - 200	45 - 50	4
Fisch, ganz in Pergamentpapier, 0,3 - 0,5 kg	190 - 200	50 - 60	3
Amaretti (20; 0,5 kg insgesamt)	170 - 180	40 - 50	3
Apfelstreusel	190 - 200	50 - 60	4
Schokoladenmuffins (20; 0,5 kg insgesamt)	160 - 170	35 - 45	3

10.17 Informationen für Prüfinstitute





Tests gemäß: EN 60350, IEC 60350.

Backen auf einer Ebene – Backen in Backformen





		 °C	 Min	
Biskuit, fettfrei	Heißluft	160	45 - 60	2
Biskuit, fettfrei	Ober- / Unterhitze	160	45 - 60	2
Apfelkuchen, 2 Formen à Ø 20 cm	Heißluft	160	55 - 65	2

		 °C	 Min	
Apfelkuchen, 2 Formen à Ø 20 cm	Ober- / Unterhitze	180	55 - 65	1
Mürbeteiggebäck	Heißluft	140	25 - 35	2
Mürbeteiggebäck	Ober- / Unterhitze	140	25 - 35	2





Backen auf einer Ebene – Kekse
Nutzen Sie die dritte Einschubebene.

		 °C	 Min
Törtchen, 20 pro Blech, Heizen Sie den leeren Backofen vor.	Heißluft	150	20 - 30
Törtchen, 20 pro Blech, Heizen Sie den leeren Backofen vor.	Ober- / Unterhitze	170	20 - 30

Backen auf mehreren Ebenen – Kekse

		 °C	 Min	
Mürbeteiggebäck	Heißluft	140	25 - 45	2 / 4
Törtchen, 20 pro Blech, Heizen Sie den leeren Backofen vor.	Heißluft	150	25 - 35	1 / 4
Biskuit, fettfrei	Heißluft	160	45 - 55	2 / 4
Apfelkuchen, 1 Backform pro Gitter (Ø 20 cm)	Heißluft	160	55 - 65	2 / 4

Grill
Heizen Sie den leeren Backofen 5 Minuten lang vor.
Grillen Sie bei maximaler Temperatureinstellung.

		 Min	
Toast	Grill	1 - 2	5
Rindersteak, Nach der Hälfte der Zeit wenden.	Grill	24 - 30	4

11. REINIGUNG UND PFLEGE

WARNUNG!

Siehe Kapitel Sicherheitshinweise.

11.1 Hinweise zur Reinigung



Reinigungsmittel

Reinigen Sie die Vorderseite des Geräts nur mit einem Mikrofasertuch mit warmem Wasser und einem milden Reinigungsmittel.

Reinigen Sie die Metalloberflächen mit einer geeigneten Reinigungslösung.

Reinigen Sie Flecken mit einem milden Reinigungsmittel.



Täglicher Gebrauch

Reinigen Sie den Garraum nach jedem Gebrauch. Fettansammlungen oder andere Speisereste könnten einen Brand verursachen.

Lassen Sie die Speisen nicht länger als 20 Minuten im Gerät stehen. Trocknen Sie den Garraum nach jedem Gebrauch nur mit einem Mikrofasertuch ab.



Zubehör

Reinigen Sie alle Zubehörteile nach jedem Gebrauch und lassen Sie sie trocknen. Verwenden Sie nur ein Mikrofasertuch mit warmem Wasser und einem milden Reinigungsmittel. Reinigen Sie die Zubehörteile nicht im Geschirrspüler.

Reinigen Sie das Zubehör mit Antihafbeschichtung nicht mit Scheuermitteln oder scharfkantigen Gegenständen.

11.2 Entfernen: Einhängegitter

Entfernen Sie Eihängegitter zur Reinigung des Backofens.

Schritt 1 Schalten Sie den Backofen aus und warten Sie, bis er abgekühlt ist.

Schritt 2 Ziehen Sie das Eihängegitter vorne von der Seitenwand weg.

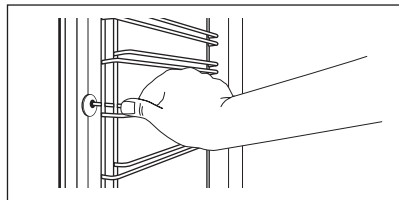

Schritt 3 Ziehen Sie das Einhängegitter hinten von der Seitenwand weg und nehmen Sie es heraus.

Schritt 4 Setzen Sie die Einhängegitter in umgekehrter Reihenfolge ein.

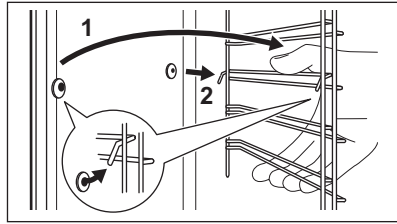

11.3 Entfernen: Grill

WARNUNG!

Es besteht Verbrennungsgefahr.

Schritt 1 Schalten Sie den Backofen aus und warten Sie, bis er abgekühlt ist, um ihn zu reinigen. Entfernen Sie die Einhängegitter.

Schritt 2 Fassen Sie die Ecken des Grills. Ziehen Sie ihn gegen die Federkraft nach vorne und aus beiden Halterungen heraus. Der Grill klappt nach unten.

Schritt 3 Reinigen Sie die Backofendecke mit warmem Wasser, einem weichen Tuch und einem milden Reinigungsmittel. Lassen Sie sie trocknen.

Schritt 4 Führen Sie zum Einsetzen des Grillelements die oben beschriebenen Schritte in umgekehrter Reihenfolge durch.

Schritt 5 Setzen Sie die Einhängegitter wieder ein.

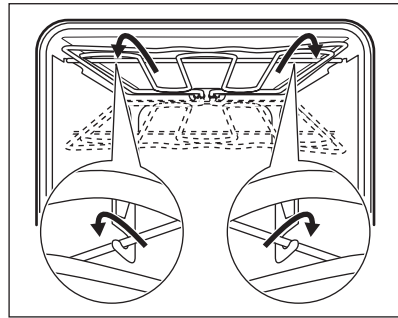

11.4 Aus- und Einbau: Tür

Sie können die Tür und inneren Glasscheiben zur Reinigung entfernen. Die Anzahl der Glasscheiben unterscheidet sich je nach Modell.

WARNUNG!

Die Tür ist schwer.

VORSICHT!

Behandeln Sie das Glas vorsichtig, insbesondere an den Kanten der vorderen Scheibe. Das Glas kann zerbrechen.

Schritt 1 Öffnen Sie die Tür vollständig.

Schritt 2 Heben Sie die Klemmhebel (A) an beiden Türscharnieren an und drücken Sie auf sie.

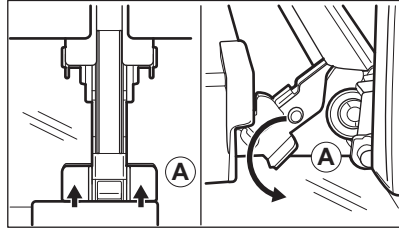

Schritt 3 Schließen Sie die Backofentür bis zur ersten Öffnungsstellung (in einem Winkel von ca. 70°). Fassen Sie die Tür mit beiden Händen seitlich an und ziehen Sie sie schräg nach oben vom Backofen weg. Legen Sie die Tür mit der Außenseite nach unten auf ein weiches Tuch und eine stabile Fläche.

Schritt 4 Fassen Sie die Türabdeckung (B) an der Oberkante der Tür an beiden Seiten an. Drücken Sie sie nach innen, um den Klippverschluss zu lösen.

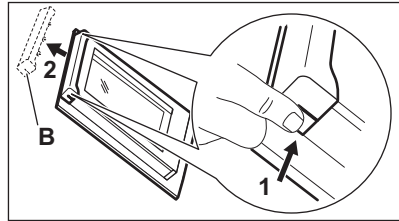

Schritt 5 Ziehen Sie die Türabdeckung nach vorn, um sie abzunehmen.

Schritt 6 Fassen Sie die Glasscheiben der Tür nacheinander am oberen Rand an und ziehen Sie sie nach oben aus den Führungen.

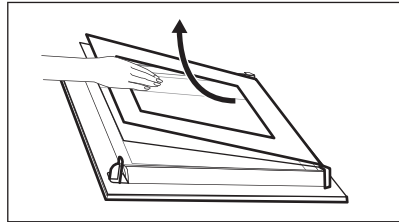

Schritt 7 Reinigen Sie die Glasscheibe mit Wasser und Spülmittel. Trocknen Sie die Glasscheibe sorgfältig ab. Reinigen Sie die Glasscheiben nicht im Geschirrspüler.

Schritt 8 Führen Sie nach der Reinigung die obigen Schritte in umgekehrter Reihenfolge durch.

Schritt 9 Setzen Sie zuerst die kleinere Scheibe ein, dann die größere Scheibe und die Tür. Stellen Sie sicher, dass die Glasscheiben in der richtigen Position eingesetzt wurden, da sich andernfalls die Türoberfläche überhitzen kann.

11.5 Austausch: Lampe

⚠️ WARNUNG!

Stromschlaggefahr.
Die Lampe kann heiß sein.

Bevor Sie die Lampe austauschen:

Schritt 1

Schalten Sie den Backofen aus.
Warten Sie, bis der Ofen kalt ist.

Schritt 2

Trennen Sie den Ofen von der Netz-
versorgung.

Schritt 3

Breiten Sie ein Tuch auf dem Gar-
raumboden aus.

Obere Lampe

Schritt 1 Drehen Sie die Glasabdeckung und nehmen Sie sie ab.

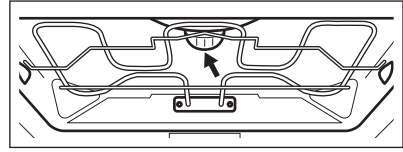

Schritt 2 Reinigen Sie die Glasabdeckung.

Schritt 3 Ersetzen Sie die Lampe durch eine geeignete, bis 300 °C hitzebeständige Lampe.

Schritt 4 Bringen Sie die Glasabdeckung an.

12. FEHLERSUCHE

⚠️ WARNUNG!

Siehe Kapitel Sicherheitshinweise.

12.1 Was zu tun ist, wenn ...

In allen Fällen, die nicht in dieser Tabelle aufgeführt sind, wenden Sie sich bitte an einen autorisierten Kundendienst.

Störung	Prüfen Sie, ob Folgendes zutrifft ...
Der Backofen heizt nicht auf.	Die Sicherung ist durchgebrannt.

Störung	Prüfen Sie, ob Folgendes zutrifft ...
Im Display wird „12.00“ angezeigt.	Es gab einen Stromausfall. Stellen Sie die Uhrzeit ein.
Die Lampe funktioniert nicht.	Die Lampe ist durchgebrannt.

12.2 Service-Daten

Wenn Sie das Problem nicht selbst lösen können, wenden Sie sich an Ihren Händler oder einen autorisierten Kundendienst.

Die vom Kundendienst benötigten Daten finden Sie auf dem Typenschild. Das Typenschild befindet sich am vorderen Rahmen des Garraums des Geräts. Entfernen Sie das Typenschild nicht vom Garraum.

Wir empfehlen Ihnen, die Daten hier zu notieren:

Modell (MOD.):

Produktnummer (PNC)

Seriennummer (S.N.)

13. ENERGIEEFFIZIENZ

13.1 Produktinformation und Produktinformationsblatt gemäß den EU-Verordnungen zu Umweltdesign und Energiekennzeichnung

Name des Lieferanten	AEG	
Modellbezeichnung	BEK435060B 944188455 EB40B 944188534	
Energieeffizienzindex	81.2	
Energieeffizienzklasse	A+	
Energieverbrauch mit einer Standardbeladung, konventioneller Modus	0.99kWh/Programm	
Energieverbrauch mit einer Standardbeladung, Umluft-Modus	0.69kWh/Programm	
Anzahl der Garräume	1	
Wärmequelle	Strom	
Volumen	71l	
Art des Backofens	Eingebauter Backofen	
Masse	BEK435060B	33.0kg
	EB40B	33.0kg

IEC/EN 60350-1 – Elektrische Kochgeräte für den Hausgebrauch – Teil 1: Herde, Backöfen, Dampföfen und Grills – Methoden zur Leistungsmessung.

13.2 Energiesparen



Das Gerät verfügt über Funktionen, mit deren Hilfe Sie beim täglichen Kochen Energie sparen können.

Stellen Sie sicher, dass die Gerätetür geschlossen ist, wenn das Gerät in Betrieb ist. Die Gerätetür darf während des Garvorgangs nicht zu oft geöffnet werden. Halten Sie die Türdichtung sauber und stellen Sie sicher, dass sie sich fest in der richtigen Position befindet.

Verwenden Sie Kochgeschirr aus Metall, um mehr Energie zu sparen.

Heizen Sie, wenn möglich, das Gerät vor dem Garvorgang nicht vor.

Wenn Sie mehrere Speisen gleichzeitig zubereiten, halten Sie die Unterbrechungen beim Backen so kurz wie möglich.

Garen mit Heißluft

Nutzen Sie, wenn möglich, die Garfunktionen mit Heißluft, um Energie zu sparen.

Restwärme

Beträgt die Garzeit mehr als 30 Minuten, reduzieren Sie die Gerätetemperatur mindestens 3 - 10 Min. vor Ablauf des Garvorgangs. Durch die Restwärme im Gerät wird der Garvorgang fortgesetzt.

Nutzen Sie die Restwärme, um andere Speisen aufzuwärmen.

Warmhalten von Speisen

Wählen Sie die niedrigste Temperatureinstellung, wenn Sie die Restwärme zum Warmhalten von Speisen nutzen möchten.

Feuchte Umluft

Diese Funktion soll während des Garvorgangs Energie sparen.

14. INFORMATIONEN ZUR ENTSORGUNG

Ihre Pflichten als Endnutzer



Dieses Elektro- bzw. Elektronikgerät ist mit einer durchgestrichenen Abfalltonne auf Rädern gekennzeichnet. Das Gerät darf deshalb nur getrennt vom unsortierten Siedlungsabfall gesammelt und zurückgenommen werden, es darf also nicht in den Hausmüll gegeben werden. Das Gerät kann z. B. bei einer kommunalen Sammelstelle oder ggf. bei einem Vertreiber (siehe zu deren Rücknahmepflichten unten) abgegeben werden. Das gilt auch für alle Bauteile, Unterbaugruppen und Verbrauchsmaterialien des zu entsorgenden Altgeräts.

Bevor das Altgerät entsorgt werden darf, müssen alle Altbatterien und Altakkumulatoren vom Altgerät getrennt werden, die nicht vom Altgerät umschlossen sind. Das gleiche gilt für Lampen, die zerstörungsfrei aus dem Altgerät entnommen werden können. Der Endnutzer ist zudem selbst dafür verantwortlich, personenbezogene Daten auf dem Altgerät zu löschen.

Hinweise zum Recycling

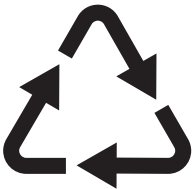

Helfen Sie mit, alle Materialien zu recyceln, die mit diesem Symbol gekennzeichnet sind. Entsorgen Sie solche Materialien, insbesondere Verpackungen, nicht im Hausmüll sondern über die bereitgestellten

Recyclingbehälter oder die entsprechenden örtlichen Sammelsysteme.

Recyceln Sie zum Umwelt- und Gesundheitsschutz auch elektrische und elektronische Geräte.

Rücknahmepflichten der Vertreiber in Deutschland

Wer auf mindestens 400 m² Verkaufsfläche Elektro- und Elektronikgeräte vertreibt oder sonst geschäftlich an Endnutzer abgibt, ist verpflichtet, bei Abgabe eines neuen Geräts ein Altgerät des Endnutzers der gleichen Geräteart, das im Wesentlichen die gleichen Funktionen wie das neue Gerät erfüllt, am Ort der Abgabe oder in unmittelbarer Nähe hierzu unentgeltlich zurückzunehmen. Das gilt auch für Vertreiber von Lebensmitteln mit einer Gesamtverkaufsfläche von mindestens 800 m², die mehrmals im Kalenderjahr oder dauerhaft Elektro- und Elektronikgeräte anbieten und auf dem Markt bereitstellen. Solche Vertreiber müssen zudem auf Verlangen des Endnutzers Altgeräte, die in keiner äußeren Abmessung größer als 25 cm sind (kleine Elektrogeräte), im Einzelhandelsgeschäft oder in unmittelbarer Nähe hierzu unentgeltlich zurückzunehmen; die Rücknahme darf in diesem Fall nicht an den Kauf eines Elektro- oder Elektronikgerätes geknüpft, kann aber auf drei Altgeräte pro Geräteart beschränkt werden.

Ort der Abgabe ist auch der private Haushalt, wenn das neue Elektro- oder Elektronikgerät dorthin geliefert wird; in diesem Fall ist die Abholung des Altgerätes für den Endnutzer kostenlos.

Die vorstehenden Pflichten gelten auch für den Vertrieb unter Verwendung von Fernkommunikationsmitteln, wenn die Vertreiber Lager- und Versandflächen für Elektro- und Elektronikgeräte bzw. Gesamtlager- und -versandflächen für Lebensmittel vorhalten, die den oben genannten Verkaufsflächen entsprechen. Die unentgeltliche Abholung von Elektro- und Elektronikgeräten ist dann aber auf Wärmeüberträger (z. B. Kühlschrank),

Bildschirme, Monitore und Geräte, die Bildschirme mit einer Oberfläche von mehr als 100 cm² enthalten, und Geräte beschränkt, bei denen mindestens eine der äußeren Abmessungen mehr als 50 cm beträgt. Für alle übrigen Elektro- und Elektronikgeräte muss der Vertreiber geeignete Rückgabemöglichkeiten in zumutbarer Entfernung zum jeweiligen Endnutzer gewährleisten; das gilt auch für kleine Elektrogeräte (s.o.), die der Endnutzer zurückgeben will, ohne ein neues Gerät zu kaufen.

Rücknahmepflichten von Vertreibern und andere Möglichkeiten der Entsorgung von Elektro- und Elektronikgeräten in der Region Wallonien

Vertreiber, die Elektro- und Elektronikgeräte verkaufen, sind verpflichtet, bei der Lieferung von Neugeräten Altgeräte desselben Typs, die im Wesentlichen die gleichen Funktionen

wie die Neugeräte erfüllen, kostenlos vom Endverbraucher zurückzunehmen. Dies gilt auch bei der Lieferung von neuen Elektro- und Elektronikgeräten oder beim Fernabsatz.

Darüber hinaus ist jeder, der Elektro- und Elektronikgeräte auf einer Verkaufsfläche von mindestens 400 m² verkauft, verpflichtet, Altgeräte, die in keiner äußeren Abmessung größer als 25 cm sind (Elektrokleingeräte), im Ladengeschäft oder in unmittelbarer Nähe kostenlos zurückzunehmen; die Rücknahme darf in diesem Fall nicht vom Kauf eines Elektro- oder Elektronikgerätes abhängig gemacht werden.

Die Rücknahme von Elektro- und Elektronikgeräten kann auch auf Containerplätzen oder zugelassenen Recyclinghöfen erfolgen. Für weitere Informationen wenden Sie sich bitte an Ihre Gemeindeverwaltung.

PER RISULTATI PERFETTI

Grazie per aver scelto di acquistare questo prodotto AEG. Lo abbiamo creato per fornirvi prestazioni impeccabili per molti anni, grazie a tecnologie innovative che vi semplificheranno la vita - funzioni che non troverete sulle normali apparecchiature. Vi invitiamo di dedicare qualche minuto alla lettura per sapere come trarre il massimo dal vostro elettrodomestico.

Visitate il nostro sito web per:



Ricevere consigli, scaricare i nostri opuscoli, eliminare eventuali anomalie, ottenere informazioni sull'assistenza e la riparazione:

www.aeg.com/support



Per registrare il vostro prodotto e ricevere un servizio migliore:

www.registeraeg.com



Acquistare accessori, materiali di consumo e ricambi originali per la vostra apparecchiatura:

www.aeg.com/shop

ASSISTENZA CLIENTI E ASSISTENZA TECNICA

Consigliamo sempre l'impiego di ricambi originali.

Quando si contatta il nostro Centro di Assistenza Autorizzato, accertarsi di avere a disposizione i dati seguenti: Modello, numero dell'apparecchio (PNC), numero di serie. Le informazioni sono riportate sulla targhetta identificativa.

 **Avvertenza/Attenzione** - Importanti Informazioni per la sicurezza

 **Informazioni generali e suggerimenti**

 **Informazioni ambientali**

Con riserva di modifiche.

INDICE

1. INFORMAZIONI DI SICUREZZA.....	176
2. ISTRUZIONI DI SICUREZZA.....	178
3. DESCRIZIONE DEL PRODOTTO.....	181
4. PANNELLO DEI COMANDI.....	181
5. PRIMA DI UTILIZZARE L'ELETTRODOMESTICO.....	182
6. UTILIZZO QUOTIDIANO.....	183
7. FUNZIONI DEL TIMER.....	184
8. UTILIZZO DEGLI ACCESSORI.....	185
9. FUNZIONI AGGIUNTIVE.....	186
10. CONSIGLI E SUGGERIMENTI UTILI.....	186
11. PULIZIA E CURA.....	198
12. RISOLUZIONE DEI PROBLEMI.....	202
13. EFFICIENZA ENERGETICA.....	202
14. CONSIDERAZIONI SULL'AMBIENTE.....	203

1. ⚠️ INFORMAZIONI DI SICUREZZA

Leggere attentamente le istruzioni fornite prima di installare e utilizzare l'apparecchiatura. I produttori non sono responsabili di eventuali lesioni o danni derivanti da un'installazione o un uso scorretti. Conservare sempre le istruzioni in un luogo sicuro e accessibile per poterle consultare in futuro.

1.1 Sicurezza di bambini e persone vulnerabili

- Quest'apparecchiatura può essere usata da bambini a partire da 8 anni di età e da adulti con capacità fisiche, sensoriali o mentali limitate o con scarsa esperienza e conoscenza sull'uso dell'apparecchiatura, solamente se sorvegliati o se istruiti relativamente all'utilizzo in sicurezza dell'apparecchiatura e se hanno compreso i rischi coinvolti. I bambini che hanno meno di 8 anni e le persone con disabilità diffuse e complesse vanno tenuti lontani dall'elettrodomestico, a meno che non vi sia una supervisione continua.
- I bambini devono essere sorvegliati per assicurarsi che non giochino con l'apparecchiatura.
- Tenere gli imballaggi lontano dai bambini e smaltirli in modo adeguato.
- **AVVERTENZA:** L'elettrodomestico e le parti accessibili si riscaldano molto durante l'uso. Tenere i bambini e gli animali domestici lontani dall'apparecchiatura durante l'uso e durante il raffreddamento.
- Se l'elettrodomestico ha un dispositivo di sicurezza per i bambini sarà opportuno attivarlo.
- I bambini non devono eseguire interventi di pulizia e manutenzione sull'elettrodomestico senza essere supervisionati.

1.2 Avvertenze di sicurezza generali

- L'apparecchiatura è destinata solo alla cottura.

- Quest'apparecchiatura è progettata per un uso domestico singolo in un ambiente interno.
- Quest'apparecchiatura può essere utilizzata in uffici, camere d'albergo, camere di bed & breakfast, alloggi in agriturismi e altre sistemazioni simili in cui tale utilizzo non superi i livelli di utilizzo domestico (medi).
- L'installazione dell'apparecchiatura e la sostituzione dei cavideve essere effettuata unicamente da personale qualificato.
- Non utilizzare l'apparecchiatura prima di installarla nella struttura a incasso.
- Prima di ogni operazione di manutenzione, scollegare l'apparecchiatura dall'alimentazione elettrica.
- Se il cavo di alimentazione è danneggiato, deve essere sostituito dal produttore, da un centro di assistenza tecnica autorizzato o da una persona qualificata per evitare situazioni di pericolo elettrico.
- **AVVERTENZA:** Assicurarsi che l'elettrodomestico sia spento prima di sostituire la lampadina per evitare la possibilità di scosse elettriche.
- **AVVERTENZA:** L'elettrodomestico e le parti accessibili si riscaldano molto durante l'uso. Prestare attenzione a non toccare le resistenze o la superficie della cavità dell'apparecchiatura.
- Utilizzare sempre guanti da forno per rimuovere o inserire accessori o pirofile.
- Per rimuovere i supporti del ripiano, tirare prima la parte anteriore del supporto del ripiano e poi l'estremità posteriore lontano dalle pareti laterali. Installare i supporti ripiani seguendo al contrario la procedura indicata.
- Non utilizzare vaporelle per pulire l'elettrodomestico.
- Non utilizzare detergenti abrasivi o raschietti di metallo per pulire il vetro dello sportello per non rigare la superficie e causare la rottura del vetro.

2. ISTRUZIONI DI SICUREZZA

2.1 Installazione

AVVERTENZA!

L'installazione dell'apparecchiatura deve essere eseguita da personale qualificato.

- Rimuovere tutti i materiali di imballaggio.
- Non installare o utilizzare l'apparecchiatura se è danneggiata.
- Attenersi alle istruzioni fornite insieme all'apparecchiatura.
- Prestare sempre attenzione in fase di spostamento dell'apparecchiatura, dato che è pesante. Usare sempre i guanti di sicurezza e le calzature adeguate.
- Non tirare l'apparecchiatura per la maniglia.
- Installare l'apparecchiatura in un luogo sicuro e idoneo che soddisfi i requisiti di installazione.
- È necessario rispettare la distanza minima dalle altre apparecchiature.
- Prima di montare l'apparecchiatura controllare che la porta dell'apparecchio si apra senza limitazioni.
- L'apparecchiatura è dotata di un sistema di raffreddamento elettrico. Quest'ultimo funziona a corrente elettrica.
- L'unità a incasso deve soddisfare i requisiti di stabilità DIN 68930.

Altezza minima del mobiletto (mobiletto sotto all'altezza minima del piano di lavoro)	578 (600) mm
---	--------------

Larghezza del mobiletto	560 mm
-------------------------	--------

Profondità del mobiletto	550 (550) mm
--------------------------	--------------

Altezza della parte anteriore dell'apparecchiatura	594 mm
--	--------

Altezza della parte posteriore dell'apparecchiatura	576 mm
---	--------

Larghezza della parte anteriore dell'apparecchiatura	595 mm
--	--------

Larghezza della parte posteriore dell'apparecchiatura	559 mm
---	--------

Profondità dell'apparecchiatura	567 mm
---------------------------------	--------

Profondità di incasso dell'apparecchiatura	546 mm
--	--------

Profondità con porta aperta	1027 mm
-----------------------------	---------

Dimensioni minime dell'apertura di ventilazione. Apertura collocata sul lato posteriore inferiore	560x20 mm
---	-----------

Lunghezza del cavo di alimentazione. Il cavo è collocato nell'angolo destro del lato posteriore	1500 mm
---	---------

Viti di montaggio	4x25 mm
-------------------	---------

2.2 Collegamento elettrico

AVVERTENZA!

Rischio di incendio e scossa elettrica.

- Tutti i collegamenti elettrici devono essere realizzati da un elettricista qualificato.
- L'apparecchiatura deve disporre di una messa a terra.
- Verificare che i parametri sulla targhetta siano compatibili con le indicazioni elettriche dell'alimentazione.
- Utilizzare sempre una presa elettrica con contatto di protezione correttamente installata.
- Non utilizzare prese multiple e prolunghe.
- Accertarsi di non danneggiare la spina e il cavo. Qualora il cavo elettrico debba essere sostituito, l'intervento dovrà essere effettuato dal nostro Centro di Assistenza autorizzato.
- Evitare che i cavi entrino a contatto o si trovino vicino alla porta dell'apparecchiatura o sulla nicchia sotto all'apparecchiatura, in particolare quando il dispositivo è in funzione o la porta è calda.
- I dispositivi di protezione da scosse elettriche devono essere fissati in modo tale da non poter essere disattivati senza l'uso di attrezzi.

- Inserire la spina di alimentazione nella presa solo al termine dell'installazione. Verificare che la spina di alimentazione rimanga accessibile dopo l'installazione.
- Nel caso in cui la spina di corrente sia allentata, non collegarla alla presa.
- Non tirare il cavo di alimentazione per scollegare l'apparecchiatura. Tirare sempre dalla spina.
- Servirsi unicamente di dispositivi di isolamento adeguati: interruttori automatici, fusibili (quelli a tappo devono essere rimossi dal portafusibile), sganciatori per correnti di guasto a terra e relè.
- L'impianto elettrico deve essere dotato di un dispositivo di isolamento che consenta di scollegare l'apparecchiatura dalla presa di corrente a tutti i poli. Il dispositivo di isolamento deve avere una larghezza dell'apertura di contatto non inferiore ai 3 mm.
- La dotazione standard dell'apparecchiatura al momento della fornitura prevede una spina e un cavo di rete.

2.3 Utilizzo:

AVVERTENZA!

Rischio di lesioni, ustioni, scosse elettriche o esplosioni.

- Non modificare le specifiche tecniche dell'apparecchiatura.
- Assicurarsi che le aperture di ventilazione non siano bloccate.
- Non lasciare l'elettrodomestico incustodito durante il funzionamento.
- Spegnerne l'elettrodomestico dopo ogni utilizzo.
- Prestare attenzione in fase di apertura dello sportello dell'elettrodomestico, quando quest'ultimo è in funzione. Può esservi un rilascio di aria calda.
- Non accendere l'elettrodomestico con le mani bagnate o quando è a contatto con l'acqua.
- Non esercitare pressione sullo sportello aperto.
- Non utilizzare l'elettrodomestico come superficie di lavoro o come superficie di deposito.

- Aprire lo sportello dell'elettrodomestico attentamente. L'utilizzo di ingredienti con alcol può provocare una miscela di alcol e aria.
- Non lasciare scintille o fiamme libere a contatto con l'elettrodomestico quando si apre lo sportello.
- Non appoggiare o tenere liquidi o materiali infiammabili, né oggetti facilmente infiammabili sull'apparecchiatura, al suo interno o nelle immediate vicinanze.

AVVERTENZA!

Vi è il rischio di danneggiare l'apparecchiatura.

- Per evitare danni o lo scolorimento dello smalto:
 - Non collocare pirofile o altri oggetti all'interno dell'elettrodomestico direttamente sul fondo.
 - Non collocare la pellicola di alluminio direttamente sul fondo della cavità dell'elettrodomestico.
 - Non versare acqua direttamente all'interno dell'elettrodomestico caldo.
 - Non conservare piatti e alimenti umidi all'interno dell'elettrodomestico dopo aver terminato la cottura.
 - Prestare attenzione in fase di rimozione o installazione degli accessori.
- Lo scolorimento dello smalto o dell'acciaio inox non influisce sulle prestazioni dell'elettrodomestico.
- Usare una leccarda per torte umide. I succhi di frutta causano macchie che possono essere permanenti.
- Eseguire sempre la cottura con lo sportello dell'apparecchiatura chiuso.
- Se l'apparecchiatura si trova dietro a un pannello anteriore (ad es. una porta), assicurarsi che questo non sia mai chiuso quando l'apparecchiatura è in funzione. Calore e umidità possono accumularsi sul retro di un pannello chiuso causando danni all'apparecchiatura, all'alloggiamento o al pavimento. Dopo l'uso non chiudere il pannello dell'armadio finché l'apparecchiatura non si è completamente raffreddata.

2.4 Pulizia e cura

AVVERTENZA!

Vi è il rischio di lesioni, incendio o danni all'apparecchiatura.

- Prima di eseguire qualunque intervento di manutenzione, spegnere l'apparecchiatura ed estrarre la spina dalla presa.
- Controllare che l'apparecchiatura sia fredda. Vi è il rischio che i pannelli in vetro si rompano.
- Sostituire immediatamente i pannelli in vetro della porta nel caso in cui siano danneggiati. Contattare il Centro Assistenza Autorizzato.
- Prestare attenzione quando si rimuove la porta dall'apparecchio. La porta è pesante!
- Pulire regolarmente l'apparecchiatura per evitare il deterioramento dei materiali che compongono la superficie.
- Pulire l'apparecchiatura con un panno inumidito e morbido. Utilizzare solo detergenti neutri. Non usare prodotti abrasivi, spugnette abrasive, solventi od oggetti metallici.
- Se si utilizza uno spray per il forno, seguire attentamente le istruzioni di sicurezza sulla confezione.

2.5 Illuminazione interna

AVVERTENZA!

Pericolo di scosse elettriche.

- Per quanto riguarda la lampada o le lampade all'interno di questo prodotto e le

lampade di ricambio vendute separatamente: Queste lampade sono destinate a resistere a condizioni fisiche estreme negli elettrodomestici, come temperatura, vibrazioni, umidità, o sono destinate a segnalare informazioni sullo stato operativo dell'apparecchio. Non sono destinate ad essere utilizzate in altre applicazioni e non sono adatte per l'illuminazione di ambienti domestici.

- Questo prodotto contiene una sorgente luminosa di classe di efficienza energetica G.
- Servirsi unicamente di lampadine con le stesse specifiche tecniche .

2.6 Assistenza

- Per far riparare l'apparecchiatura, rivolgersi a un Centro di Assistenza Autorizzato.
- Utilizzare solo ricambi originali.

2.7 Smaltimento

AVVERTENZA!

Rischio di lesioni o soffocamento.

- Contattare le autorità locali per ricevere informazioni su come smaltire correttamente l'apparecchiatura.
- Staccare la spina dall'alimentazione elettrica.
- Tagliare il cavo elettrico dell'apparecchiatura e smaltirlo.
- Togliere il blocco porta per evitare che bambini, o animali restino intrappolati nell'apparecchiatura.

3. DESCRIZIONE DEL PRODOTTO

3.1 Panoramica generale

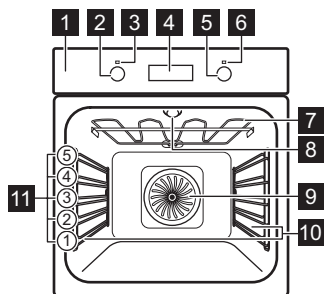

- 1 Pannello dei comandi
- 2 Manopola di regolazione delle funzioni cottura
- 3 Spia/simbolo alimentazione
- 4 Display
- 5 Manopola di regolazione (per la temperatura)
- 6 Indicatore/simbolo della temperatura
- 7 Resistenza
- 8 Lampadina
- 9 Ventola
- 10 Supporto ripiano, rimovibile
- 11 Posizioni ripiano

3.2 Accessori

Ripiano a filo

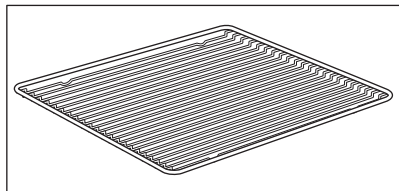

Per stoviglie, stampi per dolci, arrostiti.

Lamiera dolci

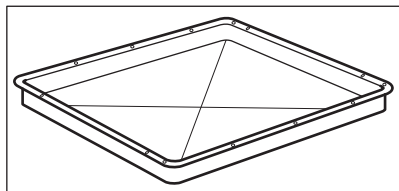

Per torte e biscotti.

Leccarda

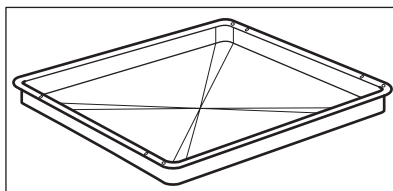

Per cuocere al forno e arrostito o per raccogliere il grasso.

4. PANNELLO DEI COMANDI

4.1 Manopola incassabile

Per utilizzare l'apparecchiatura, premere la manopola. La manopola fuoriesce.

4.2 Campo sensore / Pulsante

—	Per impostare l'ora.
	Per impostare una funzione orologio.
+	Per impostare l'ora.

4.3 Display

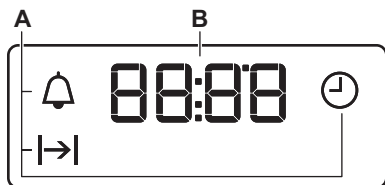

- A. Funzioni dell'orologio
- B. Timer







5. PRIMA DI UTILIZZARE L'ELETTRODOMESTICO

AVVERTENZA!

Fare riferimento ai capitoli sulla sicurezza.

5.1 Prima di utilizzare l'apparecchiatura per la prima volta

Il forno può produrre un odore sgradevole e fumo in fase di preriscaldamento. Accertarsi che la stanza sia ventilata.

		
Passaggio 1	Passaggio 2	Passaggio 3
Imposta l'orologio	Pulire il forno	Preriscaldare il forno vuoto
<ol style="list-style-type: none"> 1.  - premere per impostare l'ora. Dopo 5 secondi circa, la spia smette di lampeggiare e l'orologio indica l'ora impostata. 	<ol style="list-style-type: none"> 1. Rimuovere gli accessori e i supporti ripiano rimovibili dal forno. 2. Per pulire il forno e gli accessori, utilizza solo un panno in microfibra imbevuto di acqua tiepida e detergente delicato. 	<ol style="list-style-type: none"> 1. Impostare la temperatura massima per la funzione: . Tempo: 1 h 2. Impostare la temperatura massima per la funzione: . Tempo: 15 min.
<p>Spegnere il forno e attendere che si raffreddi. Collocare gli accessori e i supporti ripiano rimovibili nel forno.</p>		

6. UTILIZZO QUOTIDIANO





AVVERTENZA!





Fare riferimento ai capitoli sulla sicurezza.

6.1 Come impostare: Funzione cottura

Fase 1	Ruotare la manopola delle funzioni di riscaldamento per selezionare una funzione di riscaldamento.
Fase 2	Ruotare la manopola di controllo per selezionare la temperatura.
Fase 3	Al termine della cottura, ruotare le manopole fino alla posizione off per spegnere il forno.

6.2 Funzioni cottura

Funzione cottura	Applicazione
 Posizione spento	Il forno è spento.
 Luce forno	Per accendere la lampadina.
 Cottura ventilata	Per cuocere su massimo tre posizioni della griglia contemporaneamente ed essiccare i cibi. Impostare la temperatura di 20-40 °C in meno rispetto a quella per Cottura convenzionale.
 Funzione Pizza	Per preparare la pizza. Per una doratura intensa e una base croccante.
 Cottura convenzionale	Per cuocere e arrostiti alimenti su una sola posizione della griglia.

Funzione cottura	Applicazione
 Resistenza inferiore	Per dorare torte con base croccante e per conservare gli alimenti.
 Scongelamento	Per scongelare gli alimenti (verdura e frutta). Il tempo di scongelamento dipende dalla quantità e dalle dimensioni del cibo congelato.
 Cottura ventilata umida	Questa funzione è progettata per il risparmio energetico durante la cottura. Quando viene usata questa funzione, la temperatura all'interno della cavità potrebbe essere diversa rispetto alla temperatura impostata. Viene utilizzato il calore residuo. La potenza riscaldante potrebbe essere ridotta. Per ulteriori informazioni, consultare il capitolo "Uso quotidiano", Note su: Cottura ventilata umida.
 Grill	Per grigliare alimenti di ridotto spessore e tostare il pane.
 Doppio grill ventilato	Per arrostiti grandi tagli di carne o pollame con ossa su una posizione della griglia. Per gratinare e dorare.



La lampada si potrebbe spegnere automaticamente a temperature inferiori a 60 °C durante alcune funzioni del forno.

6.3 Note su: Cottura ventilata umida

Questa funzione è stata utilizzata per la conformità alla classe energetica e ai requisiti di ecodesign (secondo la normativa EU 65/2014 e EU 66/2014). Test conformemente a: IEC/EN 60350-1.

La porta del forno dovrebbe essere chiusa in fase di cottura, in modo che la funzione non venga interrotta. Ciò garantisce inoltre che il



forno funzioni con la più elevata efficienza energetica possibile.

Per le istruzioni di cottura rimandiamo al capitolo "Consigli e suggerimenti", Cottura

ventilata umida. Per indicazioni generali sul risparmio energetico rimandiamo al capitolo "Efficienza energetica", Risparmio energetico.

7. FUNZIONI DEL TIMER

7.1 Funzioni dell'orologio

Funzione orologio	Applicazione
 Ora del giorno	Permette di modificare o controllare l'ora.
 Durata	Per impostare la durata di funzionamento del forno.
 Contaminuti	Per impostare il conto alla rovescia. Questa funzione non ha effetto sull'uso del forno. È possibile impostare questa funzione in qualsiasi momento, anche quando il forno è spento.



7.2 Come impostare: Funzioni orologio



Come impostare: Ora del giorno

 - lampeggia quando si collega il forno all'alimentazione elettrica, quando c'è stato un blackout o quando il timer non è impostato.

 ,  - premere per impostare l'ora.
Dopo 5 secondi circa, la spia smette di lampeggiare e l'orologio indica l'ora impostata.

Come modificare: Ora del giorno

Passaggio 1  - premere ripetutamente per cambiare l'ora del giorno.  - inizia a lampeggiare.

Passaggio 2  ,  - premere per impostare l'ora.
Dopo 5 secondi circa, la spia smette di lampeggiare e l'orologio indica l'ora impostata.

Come impostare: Durata

Passaggio 1 Selezionare una funzione del forno e regolare la temperatura.

Passaggio 2  - premere ripetutamente.  - inizia a lampeggiare.

Passaggio 3  ,  - premere per impostare la durata.

Il display visualizza: .

 - lampeggia al termine del tempo impostato. Viene emesso un segnale acustico e il forno si spegne.



Come impostare: Durata

Passaggio 4 Premere un tasto per interrompere il segnale.

Passaggio 5 Portare la manopola nella posizione di spegnimento.

Come impostare: Contaminuti

Passaggio 1  - premere ripetutamente.  - inizia a lampeggiare.

Passaggio 2  ,  - premere per impostare l'ora.
La funzione si attiva automaticamente dopo 5 secondi.
Quando si conclude il tempo impostato, viene emesso un segnale acustico.

Passaggio 3 Premere un tasto per interrompere il segnale.

Passaggio 4 Portare la manopola nella posizione di spegnimento.

Come annullare: Funzioni orologio

Passaggio 1  - premere ripetutamente fino a quando il simbolo della funzione orologio inizia a lampeggiare.

Passaggio 2 Tenere premuto: .
La funzione orologio si disattiva dopo pochi secondi.

8. UTILIZZO DEGLI ACCESSORI

AVVERTENZA!

Fare riferimento ai capitoli sulla sicurezza.

8.1 Inserimento di accessori

Un piccolo rientro sulla parte superiore aumenta il livello di sicurezza. Gli incavi sono

anche dispositivi antiribaltamento. Il bordo alto intorno al ripiano evita che pentole e padelle scivolino dal ripiano.

Ripiano a filo:

Spingere il ripiano fra le guide del supporto.

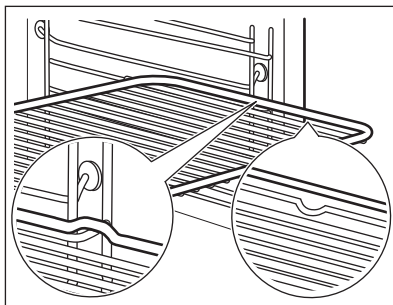
**Lamiera dolci / Teglia profonda:**

Spingere la lamiera tra le guide del supporto ripiano.

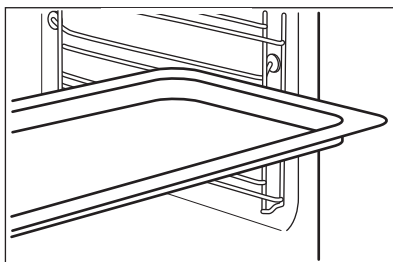

9. FUNZIONI AGGIUNTIVE

9.1 Ventola di raffreddamento

Quando l'apparecchiatura è in funzione, la ventola di raffreddamento si attiva in modo automatico per raffreddare le superfici. Dopo

aver spento l'apparecchiatura, la ventola di raffreddamento continua a funzionare finché l'apparecchiatura non si è raffreddata.

10. CONSIGLI E SUGGERIMENTI UTILI



Fare riferimento ai capitoli sulla sicurezza.

10.1 Consigli di cottura



La temperatura e i tempi di cottura specificati nella tabella sono valori indicativi. Dipendono dalle ricette, dalla qualità e quantità degli ingredienti utilizzati.

La nuova apparecchiatura può cuocere o arrostiti in modo differente rispetto all'apparecchiatura posseduta in precedenza. I suggerimenti seguenti mostrano le impostazioni consigliate per temperatura, tempo di cottura e posizione ripiano per tipi di alimenti specifici.

Qualora non si trovino le impostazioni per una ricetta speciale, cercarne una simile.

10.2 Panificare

Per la prima cottura, usare la temperatura più bassa.

È possibile estendere i tempi di cottura di 10 – 15 minuti se si cuociono torte su più di una posizione di ripiano.

Torte e dolci a diverse altezze non si dorano in modo equivalente. Non occorre modificare





l'impostazione di temperatura se si verifica una doratura non identica. Le differenze si livellano durante la cottura.





I vassoi nel forno possono distorcersi durante la cottura. Quando si raffreddano nuovamente, le distorsioni scompaiono.

10.3 Suggerimenti sulla cottura

Risultati di cottura	Causa possibile	Rimedio
Il fondo della torta non è cotto a sufficienza.	La posizione del ripiano non è corretta.	Mettere la torta nel ripiano inferiore.
La torta si affloscia e diventa inzuppata o striata.	La temperatura del forno è troppo alta.	La prossima volta impostare la temperatura del forno leggermente inferiore.
	La temperatura del forno è troppo alta e il tempo di cottura troppo corto.	La prossima volta impostare un tempo di cottura più lungo e una temperatura del forno inferiore.
La torta è troppo asciutta.	La temperatura del forno è troppo bassa.	La prossima volta impostare una temperatura del forno superiore.
	Il tempo di cottura è troppo lungo.	La prossima volta impostare un tempo di cottura più breve.
La torta si cuoce in modo non uniforme.	La temperatura del forno è troppo alta e il tempo di cottura troppo corto.	La prossima volta impostare un tempo di cottura più lungo e una temperatura del forno inferiore.
	La pastella della torta non è distribuita in modo uniforme.	La prossima volta distribuire la pastella della torta in modo uniforme nella tortiera.
La torta non è pronta nel tempo di cottura specificato nella ricetta.	La temperatura del forno è troppo bassa.	La prossima volta impostare una temperatura del forno leggermente superiore.

10.4 Cottura su un solo livello ripiano



 COTTURA IN STAMPI		 (°C)	 (min)	
Base per flan - pasta frolla, preriscaldare il forno vuoto	Cottura ventilata	170 - 180	10 - 25	2
Base per flan - miscela per pan di Spagna	Cottura ventilata	150 - 170	20 - 25	2
Ciambella / Brioches	Cottura ventilata	150 - 160	50 - 70	1

 COT- TURA IN STAMPI		 (°C)	 (min)	
Torta margherita / Torte alla frutta	Cottura ventilata	140 - 160	70 - 90	1
Cheesecake	Cottura convenzionale	170 - 190	60 - 90	1

Utilizzare la posizione del terzo ripiano.

Utilizzare la funzione: Cottura ventilata.





Usare una piastra di cottura.

 TORTE / DOLCI / PANE	 (°C)	 (min)
Torta con crumble	150 - 160	20 - 40
Flan di frutta (realizzati con pasta lievitata / miscela per pan di Spagna), utilizzare una leccarda	150	35 - 55
Flan di frutta fatte con pasta frolla	160 - 170	40 - 80





Preriscaldare il forno vuoto.

Utilizzare la funzione: Cottura convenzionale.

Usare una piastra di cottura.





 TORTE / DOLCI / PANE	 (°C)	 (min)	
Rotolo con marmellata	180 - 200	10 - 20	3
Pane di segale:	prima: 230	20	1
	poi: 160 - 180	30 - 60	
Torta di mandorle al burro / Torte di zucchero	190 - 210	20 - 30	3
Bigné / Eclair	190 - 210	20 - 35	3
Treccia / Corona di pane	170 - 190	30 - 40	3
Flan di frutta (realizzati con pasta lievitata / miscela per pan di Spagna), utilizzare una leccarda	170	35 - 55	3
Torte con lievito guarnite (ad es. formaggio morbido, panna, crema)	160 - 180	40 - 80	3
Christstollen	160 - 180	50 - 70	2

Utilizzare la posizione del terzo ripiano.

 BISCOTTI		 (°C)	 (min)
Biscotti di pasta frolla	Cottura ventilata	150 - 160	10 - 20
Panini, preriscaldare il forno vuoto	Cottura ventilata	160	10 - 25
Biscotti realizzati con miscela per pan di Spagna	Cottura ventilata	150 - 160	15 - 20
Pasticcini di pasta sfoglia, preriscaldare il forno vuoto	Cottura ventilata	170 - 180	20 - 30
Biscotti realizzati con pasta lievitata	Cottura ventilata	150 - 160	20 - 40
Meringhe	Cottura ventilata	100 - 120	30 - 50
Pasticcini agli albumi / Meringhe	Cottura ventilata	80 - 100	120 - 150
Panini, preriscaldare il forno vuoto	Cottura convenzionale	190 - 210	10 - 25

10.5 Sfornati e gratinati





Utilizzare la posizione del primo ripiano.





		 (°C)	 (min)
Baguette ricoperte di formaggio fuso	Cottura ventilata	160 - 170	15 - 30
Verdure gratinate, preriscaldare il forno vuoto	Doppio grill ventilato	160 - 170	15 - 30
Lasagne	Cottura convenzionale	180 - 200	25 - 40
Sfornati di pesce	Cottura convenzionale	180 - 200	30 - 60
Verdure ripiene	Cottura ventilata	160 - 170	30 - 60
Dolci	Cottura convenzionale	180 - 200	40 - 60
Pasta al forno	Cottura convenzionale	180 - 200	45 - 60

10.6 Cottura multilivello

Utilizzare la funzione: Cottura ventilata.

Usare le piastre.

 TORTE/ DOLCI	 (°C)	 (min)	 2 posizioni
Bigné / Eclair, preriscaldare il forno vuoto	160 - 180	25 - 45	1 / 4
Torta Streusel secca	150 - 160	30 - 45	1 / 4

 BI- SCOTTI / TORTE PICCOLE / PA- STA / ROLL	 (°C)	 (min)	 2 posizioni	3 posizioni
Panini	180	20 - 30	1 / 4	-
Biscotti di pasta frolla	150 - 160	20 - 40	1 / 4	1 / 3 / 5
Biscotti realizzati con miscela per pan di Spagna	160 - 170	25 - 40	1 / 4	-
Pasticcini di pasta sfoglia, preriscaldare il forno vuoto	170 - 180	30 - 50	1 / 4	-
Biscotti realizzati con pasta lievitata	160 - 170	30 - 60	1 / 4	-
Meringhe	100 - 120	40 - 80	1 / 4	-
Biscotti con albumi / Meringhe	80 - 100	130 - 170	1 / 4	-

10.7 Suggerimenti per l'arrostitura

Utilizzare pentolame da forno resistente al calore.

Arrostire la carne magra coperta (è possibile usare pellicola di alluminio).

Arrostire grossi tagli di carne direttamente nel vassoio.

Mettere un po' d'acqua nel vassoio onde evitare la bruciatura del grasso che cola.

Girare l'arrosto dopo 1/2 - 2/3 del tempo di cottura.

Arrostire la carne e il pesce in pezzi di grandi dimensioni (1 kg o più).

Se viene suggerito il livello uno, mettere il cibo direttamente sulla lamiera dolci

Ungere diverse volte i pezzi di carne con il proprio sugo durante l'arrostimento.

10.8 Cottura arrosto

Utilizzare la posizione del primo ripiano.



MANZO



(°C)



(min.)

Stufato	1 - 1,5 kg	Cottura convenzionale	230	120 - 150
Roast beef o filetto, al sangue, preriscaldare il forno vuoto	per cm di altezza	Doppio grill ventilato	190 - 200	5 - 6
Roastbeef o filetto, cottura media, preriscaldare il forno vuoto	per cm di altezza	Doppio grill ventilato	180 - 190	6 - 8
Roastbeef o filetto, ben cotto, preriscaldare il forno vuoto	per cm di altezza	Doppio grill ventilato	170 - 180	8 - 10



MAIALE



Utilizzare la funzione: Doppio grill ventilato.



(kg)



(°C)



(min.)

Spalla / Collo / Coscia	1 - 1,5	160 - 180	90 - 120
Braciole / Costoletta di maiale	1 - 1,5	170 - 180	60 - 90
Polpettone	0,75 - 1	160 - 170	50 - 60
Stinco di maiale, precotto	0,75 - 1	150 - 170	90 - 120



VITELLO



Utilizzare la funzione: Doppio grill ventilato.



(kg)



(°C)



(min.)

Arrosto di vitello	1	160 - 180	90 - 120
Stinco di vitello	1,5 - 2	160 - 180	120 - 150



AGNELLO



Utilizzare la funzione: Doppio grill ventilato.



(kg)



(°C)



(min.)

Coscia d'agnello / Arrosto di agnello

1 - 1.5

150 - 170

100 - 120

Sella d'agnello

1 - 1.5

160 - 180

40 - 60



SELVAGGINA



Utilizzare la funzione: Cottura convenzionale.



(kg)



(°C)



(min.)

Sella / Coscia di lepore, preriscaldare il forno vuoto

fino a 1

230

30 - 40

Sella di capriolo

1.5 - 2

210 - 220

35 - 40

Coscia di capriolo

1.5 - 2

180 - 200

60 - 90



POLLAME



Utilizzare la funzione: Doppio grill ventilato.



(kg)



(°C)



(min.)

Pollame, porzioni

0,2 - 0,25 ciascuno

200 - 220

30 - 50

Mezzo pollo

0,4 - 0,5 ciascuno

190 - 210

35 - 50

Pollo, pollastra

1 - 1.5

190 - 210

50 - 70

Anatra

1.5 - 2

180 - 200

80 - 100

Oca

3.5 - 5

160 - 180

120 - 180

Tacchino

2.5 - 3.5

160 - 180

120 - 150

Tacchino

4 - 6

140 - 160

150 - 240



PESCE (STUFATO)



Utilizzare la funzione: **Cottura convenzionale.**



(kg)



(°C)



(min.)

Pesce intero

1 - 1.5

210 - 220

40 - 60

10.9 Cottura croccante con: Funzione Pizza



IMPOSTAZIONE



Utilizzare la posizione del primo ripiano.



(°C)



(min.)

Crostate

180 - 200

40 - 55

Flan spinaci

160 - 180

45 - 60

Quiche lorraine / Flan svizzero

170 - 190

45 - 55

Cheesecake

140 - 160

60 - 90

Torta di verdure

160 - 180

50 - 60



IMPOSTAZIONE



Preriscaldare il forno vuoto prima di iniziare a utilizzarlo.



Utilizzare la posizione del secondo ripiano.



(°C)



(min.)

Pizza, crosta sottile, utilizzare una leccarda

200 - 230

15 - 20

Pizza, crosta spessa

180 - 200

20 - 30

Pane non lievitato

230 - 250

10 - 20

Flan di pasta sfoglia

160 - 180

45 - 55

Flammkuchen (tarte flambée)

230 - 250

12 - 20

Pierogi

180 - 200

15 - 25

10.10 Grill

Preriscaldare il forno vuoto prima di iniziare a utilizzarlo.

Cuocere al grill solo pezzi di carne o pesce sottili.

Mettere una pentola sulla posizione del primo ripiano per raccogliere i grassi.



GRILL



Utilizzare la funzione: Grill



(°C)



(min.)
1° lato



(min.)
2° lato



	(°C)	(min.) 1° lato	(min.) 2° lato	
Roast beef	210 - 230	30 - 40	30 - 40	2
Filetto di manzo	230	20 - 30	20 - 30	3
Lonza di maiale	210 - 230	30 - 40	30 - 40	2
Lonza di vitello	210 - 230	30 - 40	30 - 40	2
Sella d'agnello	210 - 230	25 - 35	20 - 25	3
Pesce intero, 0,5 kg - 1 kg	210 - 230	15 - 30	15 - 30	3 / 4

10.11 Cibi congelati



SBRINAMENTO



Utilizzare la funzione: Cottura ventilata.



(°C)



(min.)



	(°C)	(min.)	
Pizza, surgelata	200 - 220	15 - 25	2
Pizza Americana surgelata	190 - 210	20 - 25	2
Pizza fredda	210 - 230	13 - 25	2
Pizzette surgelate	180 - 200	15 - 30	2
Patatine fritte sottili	200 - 220	20 - 30	3
Patatine fritte spesse	200 - 220	25 - 35	3
Spicchi / Crocchette	220 - 230	20 - 35	3
Sformato di patate	210 - 230	20 - 30	3
Lasagne / Cannelloni freschi	170 - 190	35 - 45	2
Lasagne / Cannelloni surgelati	160 - 180	40 - 60	2
Cheesecake cotta	170 - 190	20 - 30	3
Ali di pollo	190 - 210	20 - 30	2

10.12 Scongellamento





Rimuovere gli alimenti dall'imballaggio e metterli su una piastra.

Non coprire il cibo, in quanto ciò può prolungare il tempo di sbrinamento.

Per grandi porzioni di cibo posizionare una piastra vuota capovolta sul fondo della cavità

Usare il primo livello griglia.

del forno. Mettere il cibo in un piatto profondo e collocarlo sulla parte superiore della piastra all'interno del forno. Se necessario, rimuovere i supporti del ripiano.

	 (kg)	 (min) Tempo di scongelamento	 (min) Ulteriore tempo di sbrinamento	
Pollo	1	100 - 140	20 - 30	Girare a metà tempo.
Carne	1	100 - 140	20 - 30	Girare a metà tempo.
Trota	0,15	25 - 35	10 - 15	-
Fragole	0,3	30 - 40	10 - 20	-
Burro	0,25	30 - 40	10 - 15	-
Panna	2 x 0,2	80 - 100	10 - 15	Frustare la crema quando ancora leggermente congelata in alcune zone.
Gateau	1,4	60	60	-

10.13 Marmellate/Conserve

Utilizzare la funzione Resistenza inferiore.

Utilizzare esclusivamente vasi da conserva delle stesse dimensioni disponibili sul mercato.

Non utilizzare vasi con coperchi a scatto o a baionetta o lattine metalliche.

Utilizzare la posizione del primo ripiano.

Non collocare più di 6 vasi da conserva da un litro sul vassoio di cottura.

Riempire i vasi in modo equo e chiudere con un morsetto.



I vasi non devono toccarsi tra loro.



Mettere circa 1/2 litro d'acqua nel vassoio di cottura per fornire sufficiente umidità al forno.



Quando il liquido nei vasi inizia a sobbollire (dopo circa 35 - 60 minuti con vasi da un

litro), spegnere il forno o diminuire la temperatura a 100°C (vedere la tabella).

Impostare la temperatura a 160 - 170 °C.

 FRUTTA MORBIDA	 (min) Tempi di cottura fino alla comparsa delle prime bollicine
Fragole / Mirtilli / Lamponi / Uva spina matura	35 - 45

 DRUPA	 (min) Tempi di cottura fino alla comparsa delle prime bollicine	 (min) Tempi di cottura restanti a 100°C
Pesche / Mele cotogne / Prugne	35 - 45	10 - 15

 VERDURE	 (min) Tempi di cottura fino alla comparsa delle prime bollicine	 (min) Tempi di cottura restanti a 100°C
Carote	50 - 60	5 - 10
Cetrioli	50 - 60	-
Sottaceti misti	50 - 60	5 - 10
Cavolo rapa / Piselli / Asparago	50 - 60	15 - 20

10.14 Essiccazione - Cottura ventilata

Coprire le teglie con carta resistente al grasso o carta da forno.

10.15 Cottura ventilata umida - accessori consigliati

Usare scatole e contenitori scuri e non riflettenti. Assorbono meglio il calore rispetto al colore chiaro e ai piatti riflettenti.



Teglia da pizza

Scura, non riflettente
28 cm di diametro



Pirofila

Scura, non riflettente
26 cm di diametro



Pirofile monoporzione

Ceramica
diametro 8 cm, altezza 5 cm





Tortiera per flan

Scura, non riflettente
28 cm di diametro



Per ottenere risultati migliori, spegnere il forno a metà del tempo di asciugatura, aprire lo sportello e lasciarlo raffreddare per una notte per completare l'asciugatura.

Per 1 teglia usare la terza posizione ripiano.

Per 2 teglie usare la prima e quarta posizione ripiano.





 VERDURE	 (°C)	 (ore)
Fagioli	60 - 70	6 - 8
Peperoni	60 - 70	5 - 6
Verdure per zuppa	60 - 70	5 - 6
Funghi	50 - 60	6 - 8
Erbe	40-50	2 - 3

Impostare la temperatura su 60 - 70 °C.

 FRUTTA	 (ore)
Prugne	8 - 10
Albicocche	8 - 10
Fette di mela	6 - 8
Pere	6 - 9

10.16 Cottura ventilata umida





Per ottenere i risultati migliori, attenersi ai suggerimenti elencati nella tabella sottostante.

	 (°C)	 (min.)	
Grissini, 0,5 kg in totale	190 - 200	50 - 60	3
Capesante in conchiglia al forno	180 - 200	30 - 40	4
Pesce intero in sale, 0,3 - 0,5 kg	190 - 200	45 - 50	4
Pesce intero in carta da forno, 0,3 - 0,5 kg	190 - 200	50 - 60	3
Amaretti (20; 0,5 kg in totale)	170 - 180	40 - 50	3
Crumble di mele	190 - 200	50 - 60	4
Muffin al cioccolato (20; 0,5 kg in totale)	160 - 170	35 - 45	3

10.17 Informazioni per gli istituti di test





Test conformemente a: EN 60350, IEC 60350.





Cottura al forno su un livello - cottura in stampi

		 °C	 min	
Pan di Spagna senza grassi	Cottura ventilata	160	45 - 60	2
Pan di Spagna senza grassi	Cottura convenzionale	160	45 - 60	2
Torta di mele americana, 2 stampi Ø20 cm	Cottura ventilata	160	55 - 65	2
Torta di mele americana, 2 stampi Ø20 cm	Cottura convenzionale	180	55 - 65	1
Frollini al burro	Cottura ventilata	140	25 - 35	2
Frollini al burro	Cottura convenzionale	140	25 - 35	2





Cottura al forno su un livello - biscotti

Utilizzare la posizione del terzo ripiano.

		 °C	 min
Tortine, 20 per teglia, preriscalda- re il forno vuoto	Cottura ventilata	150	20 - 30

		 °C	 min
Tortine, 20 per teglia, preriscaldare il forno vuoto	Cottura convenzionale	170	20 - 30





Cottura al forno multilivello - biscotti

		 °C	 min	
Frollini al burro	Cottura ventilata	140	25 - 45	2 / 4
Tortine, 20 per teglia, preriscaldare il forno vuoto	Cottura ventilata	150	25 - 35	1 / 4
Pan di Spagna senza grassi	Cottura ventilata	160	45 - 55	2 / 4
Crostata di mele, 1 stampo per griglia (Ø 20 cm)	Cottura ventilata	160	55 - 65	2 / 4

Grill

Preriscaldare il forno vuoto per 5 minuti.

Grigliare con l'impostazione di temperatura massima.

		 min	
Toast	Grill	1 - 2	5
Manzo, bistecca, girare il piatto a metà cottura	Grill	24 - 30	4

11. PULIZIA E CURA

AVVERTENZA!

Fare riferimento ai capitoli sulla sicurezza.

11.1 Note sulla pulizia



Agenti di pulizia

Pulire la parte anteriore dell'apparecchiatura solo con un panno in microfibra imbevuto di acqua tiepida e detergente delicato.

Servirsi di una soluzione detergente per pulire le superfici metalliche.

Pulire le macchie con un detergente delicato.



Usò quotidiano

Pulire la cavità dopo ogni utilizzo. L'accumulo di grasso o di altri residui potrebbe causare un incendio.

Non lasciare le vivande nell'apparecchiatura per piú di 20 minuti. Asciugare la cavità dopo ogni utilizzo solo con un panno in microfibra.



Accessori

Pulire tutti gli accessori dopo ogni utilizzo e lasciarli asciugare. Utilizzare solo un panno in microfibra imbevuto di acqua tiepida e un detergente delicato. Non pulire gli accessori in lavastoviglie.

Non pulire gli accessori anti-aderenti con agenti abrasivi o oggetti appuntiti.

11.2 Come rimuovere: Supporti del ripiano

Rimuovere i supporti ripiano per pulire il forno.

Passaggio 1 Spegnerò il forno e attendere che si raffreddi.

Passaggio 2 Sfilare dapprima la guida di estrazione dalla parete laterale tirandola in avanti.

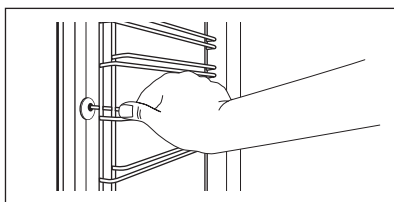

Passaggio 3 Estrarre la parte posteriore del supporto ripiano dalla parete laterale e rimuoverla.

Passaggio 4 Installare i supporti ripiani seguendo al contrario la procedura indicata.

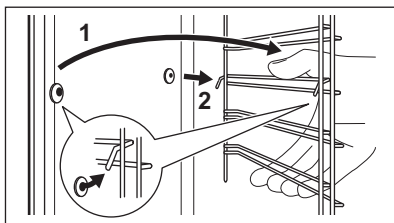

11.3 Come togliere: Grill

AVVERTENZA!

Pericolo di ustione.

- Fase 1** Spegner il forno e attendere che sia freddo per pulirlo.
Rimuovere i supporti ripiano.
- Fase 2** Tirarlo in avanti contro la molla a pressione ed estrarlo dai due supporti. La griglia si piega.
- Fase 3** Pulire la parte superiore del forno con acqua tiepida, un panno morbido e detergente delicato. Lasciare asciugare.
- Fase 4** Installare la griglia seguendo al contrario la procedura indicata.

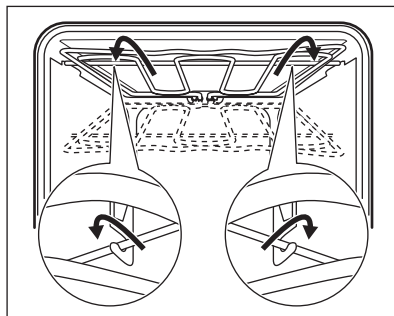

- Fase 5** Montare i supporti ripiano.

11.4 Procedura di rimozione e installazione: Porta

È possibile rimuovere la porta e i pannelli in vetro interni per procedere alle operazioni di pulizia. Il numero di pannelli di vetro varia a seconda dei modelli.

⚠ AVVERTENZA!

La porta è pesante.

⚠ ATTENZIONE!

Maneggiare con cura il vetro, in particolare intorno ai bordi del pannello frontale. Il vetro può rompersi.

- Passaggio 1** Aprire completamente la porta.

- Passaggio 2** Sollevare e premere le leve di serraggio (A) sulle due cerniere.

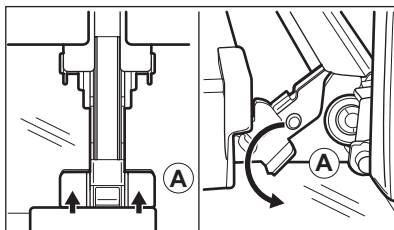

- Passaggio 3** Chiudere la porta del forno fino alla prima posizione di apertura (un angolo di circa 70°). Afferrare la porta su entrambi i lati e tirarla fino ad allontanarla dal forno mantenendo un'inclinazione verso l'alto. Poggiare la porta con il lato esterno rivolto verso il basso su un panno morbido su una superficie stabile.

Passaggio 4 Tenere il rivestimento della porta (B) sul bordo superiore della porta da entrambi i lati e spingere verso l'interno per sbloccare la guarnizione a clip.

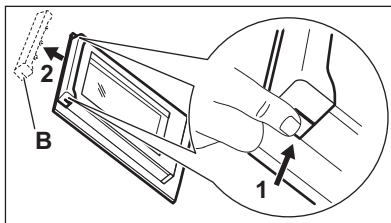

Passaggio 5 Rimuovere il rivestimento tirandolo in avanti.

Passaggio 6 Afferrare uno ad uno i pannelli di vetro della porta dal bordo superiore e estrarli dalla guida.

Passaggio 7 Pulire il pannello in vetro con acqua e sapone. Asciugare con cura il pannello in vetro. Non pulire i pannelli in vetro in lavastoviglie.

Passaggio 8 Dopo la pulizia, eseguire i passaggi di cui sopra nella sequenza opposta.

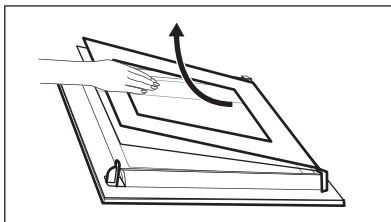

Passaggio 9 Installare per primo il pannello più piccolo, poi quello più grande e la porta. Verificare che i pannelli in vetro vengano inseriti nella posizione corretta, altrimenti la superficie della porta potrebbe surriscaldarsi.

11.5 Come sostituire: Lampadina

⚠ AVVERTENZA!

Pericolo di scosse elettriche.
La lampada potrebbe essere calda.

Prima di sostituire la lampadina:

Passaggio 1

Spegnere il forno. Attendere che il forno sia freddo.

Passaggio 2

Estrarre la spina dalla presa di corrente.

Passaggio 3

Appoggiare un panno sul fondo della cavità.

Lampadina superiore

Passaggio 1 Girare il rivestimento di vetro per toglierlo.

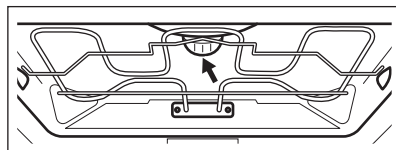

Passaggio 2 Pulire il coperchio in vetro.

Passaggio 3 Sostituire la lampadina con una resistente al calore fino a 300 °C.

Passaggio 4 Installare il coperchio in vetro.

12. RISOLUZIONE DEI PROBLEMI

AVVERTENZA!

Fare riferimento ai capitoli sulla sicurezza.

12.1 Cosa fare se...

Per tutti i casi non inclusi in questa tabella si prega di contattare un Centro di assistenza autorizzato.

12.2 Dati dell'Assistenza

Qualora non sia possibile trovare una soluzione al problema, contattare il rivenditore o un Centro di assistenza autorizzato.

Le informazioni necessarie per il Centro Assistenza si trovano sulla targhetta dei dati. La targhetta si trova sul telaio anteriore della cavità dell'apparecchiatura. Non rimuovere la targhetta dei dati dalla cavità dell'apparecchiatura.

Problema	Controllare se...
Il forno non scalda.	È saltato il fusibile.
Il display mostra "12.00".	Si è verificata un'interruzione dell'alimentazione elettrica. Impostare l'ora.
La lampadina non funziona.	La lampadina è bruciata.

Consigliamo di annotare i dati qui:

Modello (Mod.)

Codice prodotto (PNC)

Numero di serie (S.N.)

13. EFFICIENZA ENERGETICA

13.1 Informazioni sul prodotto e scheda informativa del prodotto in conformità alla normativa europea sull'ecodesign e sull'etichettatura energetica

Nome del fornitore	AEG
Identificazione modello	BEK435060B 944188455 EB40B 944188534
Indice di efficienza energetica	81.2
Classe di efficienza energetica	A+
Consumo energetico con carico standard, modalità tradizionale	0.99kWh/ciclo

Consumo di energia con un carico standard, modalità a circolazione d'aria forzata	0.69kWh/ciclo	
Numero di cavità	1	
Fonte di calore	Elettricità	
Volume	71l	
Tipo di forno	Forno da incasso	
Massa	BEK435060B	33.0kg
	EB40B	33.0kg

IEC/EN 60350-1 - Apparecchiature elettriche per la cottura per uso domestico - Parte 1: Cucine, forni, forni a vapore e griglie - Metodi per la misura delle prestazioni.

13.2 Risparmio energetico



L'apparecchiatura ha di funzioni che consentono di aiutarvi a risparmiare energia durante le operazioni di cottura di tutti i giorni.

Assicurarsi che la porta dell'apparecchiatura sia chiusa quando l'apparecchiatura è in funzione. Non aprire troppo spesso la porta durante la cottura. Tenere pulita la guarnizione della porta e assicurarsi che sia ben fissata nella posizione corretta.

Servirsi di pentole in metallo per migliorare il risparmio energetico .

Ove possibile, non pre-riscaldare l'apparecchiatura prima della cottura.

Ridurre quanto più possibile gli intervalli fra le diverse operazioni di cottura quando vengono preparati più piatti contemporaneamente.

Cucinare con ventola

Ove possibile, servirsi delle funzioni di cottura con la ventola per risparmiare energia.

Calore residuo

Quando la durata di cottura è superiore ai 30 minuti, ridurre la temperatura dell'apparecchiatura al minimo 3-10 minuti prima della fine del processo di cottura. La cottura proseguirà grazie al calore residuo all'interno dell'apparecchiatura.

Utilizzare il calore residuo per scaldare altri piatti.

Tenere in caldo gli alimenti

Scegliere l'impostazione di temperatura più bassa per sfruttare il calore residuo e mantenere calda la pietanza.

Cottura ventilata umida

Funzione progettata per risparmiare energia in fase di cottura.

14. CONSIDERAZIONI SULL'AMBIENTE

Riciclare i materiali con il simbolo . Buttare l'imballaggio negli appositi contenitori per il riciclaggio. Aiutare a proteggere l'ambiente e la salute umana e a riciclare rifiuti derivanti da apparecchiature elettriche ed elettroniche. Non smaltire le apparecchiature che riportano

il simbolo insieme ai normali rifiuti domestici. Portare il prodotto al punto di riciclaggio più vicino o contattare il comune di residenza.

FOR PERFEKTE RESULTATER

Takk for at du valgte dette AEG-produktet. Vi har laget det for å gi deg perfekt ytelse i mange år, med innovativ teknologi som bidrar til å gjøre livet enklere – egenskaper som du kanskje ikke finner på ordinære apparater. Bruk noen minutter på å lese dette, for å få mest mulig ut av den.

Gå inn på nettsiden vår for å:



Få råd om bruk, brosjyrer, hjelp til feilsøking, og informasjon om service og reparasjon:

www.aeg.com/support



Registrer produktet for å få bedre service:

www.registeraeg.com



Kjøp tilbehør, forbruksvarer og originale reservedeler til apparatet ditt:

www.aeg.com/shop

KUNDESTØTTE OG SERVICE

Bruk alltid originale reservedeler.

Når du kontakter vårt autoriserte servicesenter, må du sørge for at du har følgende opplysninger tilgjengelig: Modell, PNC, serienummer.

Informasjonen finner du på typeskiltet.

 Advarsel/Forsiktig – Sikkerhetsinformasjon

 Generell informasjon og tips

 Miljøinformasjon

Med forbehold om endringer.

INNHOOLD

1. SIKKERHETSINFORMASJON.....	205
2. SIKKERHETSANVISNINGER.....	206
3. PRODUKTBEKRIVELSE.....	209
4. BETJENINGSPANEL.....	209
5. FØR FØRSTEGANGS BRUK.....	210
6. DAGLIG BRUK.....	210
7. KLOKKEFUNKSJONER.....	212
8. BRUKE TILBEHØRET.....	213
9. TILLEGGSFUNKSJONER.....	214
10. HJELP OG TIPS.....	214
11. STELL OG RENGJØRING.....	226
12. FEILSØKING.....	229
13. ENERGIEFFEKTIV.....	230
14. BESKYTTELSE AV MILJØET.....	231

1. ⚠️ SIKKERHETSINFORMASJON

Les medfølgende instruksjoner nøye innen du installerer og bruker apparatet. Produsenten er ikke ansvarlig for personskader eller andre skader som følge av feilaktig montering eller bruk. Hold alltid instruksjonene på et trygt og tilgjengelig sted for fremtidig referanse.

1.1 Sikkerhet for barn og sårbare mennesker

- Dette produktet kan brukes av barn fra 8 år og oppover og personer med reduserte fysiske, sensoriske eller mentale evner eller manglende erfaring og kunnskap, dersom de får tilsyn eller instruksjoner om bruken av produktet på en sikker måte, og forstår farene som er involvert. Barn under 8 år og personer med svært omfattende og komplekse funksjonsnedsettelse må holdes på avstand fra produktet med mindre de er under tilsyn til enhver tid.
- Barn bør være under oppsyn for å sikre at de ikke leker med produktet.
- Oppbevar all emballasje utilgjengelig for barn og kast den på riktig måte.
- ADVARSEL: Produktet og tilgjengelige deler blir varme under bruk. Hold barn og kjæledyr borte fra apparatet når det er i bruk og når det kjøles ned.
- Hvis produktet har en barnesikring, bør den aktiveres.
- Rengjøring og vedlikehold av produktet skal ikke utføres av barn.

1.2 Generell sikkerhet

- Dette produktet skal kun brukes til matlaging.
- Dette produktet er beregnet for bruk innendørs.
- Dette produktet kan brukes på kontorer, hotellrom, rom for bed & breakfast, gårdsgjestehus og andre lignende steder hvor slik bruk ikke overstiger (gjennomsnittlig) bruksnivåer for husholdningsrom.

- Bare en kvalifisert person må montere produktet og skifte ut kablet.
- Bruk ikke produktet før du installerer det i en innebygget enhet.
- Trekk støpselet ut av stikkontakten før du utfører vedlikehold.
- Om tilførselsledningen er skadet må den erstattes av produsenten, et autorisert servicesenter eller tilsvarende kvalifiserte personer for å unngå at den kan utgjøre en elektrisk fare.
- **ADVARSEL:** Sørg for at produktet er slått av før du bytter lampen for å unngå fare for elektrisk støt.
- **ADVARSEL:** Produktet og tilgjengelige deler blir varme under bruk. Vær forsiktig så du ikke berører varmeelementene eller produktrommets overflate.
- Bruk alltid grillvotter til å fjerne eller sette inn tilbehør eller ovnsstyr.
- For å fjerne ovnsstigene, må du først trekke dem ut i front og siden i bakkant. Monter ovnsstigene i motsatt rekkefølge.
- Ikke bruk damprengjøring til å rengjøre produktet.
- Ikke bruk skurende rengjøringsmidler eller skarpe skrapegjenstander av metall for å rengjøre glassdøren, da dette kan ripe opp glasset og føre til at glasset blir matt.

2. SIKKERHETSANVISNINGER

2.1 Montering

ADVARSEL!

Bare en kvalifisert person må montere dette produktet.

- Fjern all emballasje.
- Ikke monter eller bruk et skadet produkt.
- Følg installasjonsanvisningene som følger med produktet.
- Vær alltid forsiktig når du flytter produktet. Det er tungt. Bruk alltid vernebriller og lukket fotføy.
- Ikke dra eller løft produktet etter håndtaket.
- Monter produktet på et trygt og egnet sted som oppfyller monteringskrav.
- Overhold minimumsavstanden fra andre produkter og enheter.
- Før du monterer produktet, sjekk at produkt døren åpner uten hindring.
- Produktet er utstyrt med et elektrisk kjølesystem. Det må brukes med elektrisk strømforsyning.
- Innbyggingsenheten må møte kravene til stabilitet i DIN 68930.

Minstehøyde for skap (minstehøyde for skap under benkeplate)	578 (600) mm
Skapbredde	560 mm
Skapdybde	550 (550) mm
Høyden av fronten av produktet	594 mm
Høyden av baksiden av produktet	576 mm
Bredden av fronten av produktet	595 mm
Bredden av baksiden av produktet	559 mm
Dybden av produktet	567 mm
Produktets innebygde dybde	546 mm
Dybde med døren åpen	1027 mm
Minsteåpning for ventilasjon. Åpning er plassert på nedre bakside	560x20 mm
Lengden på strømledningen. Strømledningen finner du i høyre hjørne på baksiden	1500 mm
Monteringsskruer	4x25 mm

2.2 Elektrisk tilkobling

ADVARSEL!

Fare for brann og elektrisk støt.

- Alle elektriske tilkoblinger skal utføres av en kvalifisert elektriker.
- Produktet må være jordet.
- Kontroller at parameterne på typeskiltet er kompatible med de elektriske spesifikasjonene i strømforsyningen.
- Bruk alltid en korrekt montert, jordet stikkontakt.
- Ikke bruk grenuttak eller skjøteledninger.
- Pass på at støpselet og strømkabelen ikke påføres skade. Hvis strømkabelen må erstattes, må dette utføres av vårt Autoriserte servicesenter.
- Strømkablene må ikke berøre eller komme nær apparatets dør eller sprekken under apparatet, spesielt ikke når den er i bruk eller når døren er varm.

- Beskyttelsen mot elektrisk støt fra strømførende og isolerte deler må festes på en måte som gjør at den ikke kan fjernes uten verktøy.
- Ikke sett støpselet i stikkontakten før monteringen er fullført. Påse at det er tilgang til stikkontakten etter monteringen.
- Hvis stikkontakten er løs skal du ikke sette i støpselet.
- Ikke trekk i kablet for å koble fra produktet. Trekk alltid i selve støpselet.
- Bruk kun korrekte isoleringsenheter: vernebrytere, sikringer (sikringer av skrutypen fjernet fra holderen), jordfeilbrytere og kontaktorer.
- Den elektriske monteringen må ha en isoleringsenhet som lar deg frakoble apparatet fra strømmettet ved alle poler. Isoleringsenheten må ha en kontaktåpningsbredde på minst 3 mm.
- Produktet leveres med støpsel og strømledning.

2.3 Bruk

ADVARSEL!

Risiko for skade, brannskader og elektrisk støt eller eksplosjon.

- Produktets spesifikasjoner må ikke endres.
- Pass på at ventilasjonsåpningene ikke er blokkerte.
- Ikke la produktet være uten tilsyn mens det er i drift.
- Slå av produktet etter hver bruk.
- Vær forsiktig når du åpner døren til produktet når det er i bruk. Varmluft kan slippe ut.
- Ikke bruk produktet med våte hender eller når det er i kontakt med vann.
- Ikke belast døren når den er åpen.
- Bruk ikke produktet som arbeids- eller oppbevaringsflate.
- Åpne døren til produktet forsiktig. Bruk av ingredienser med alkohol kan føre til en blanding av alkohol og luft.
- Ikke la gnister eller åpne flammer komme i kontakt med produktet når du åpner døren.
- Legg ikke brennbare produkter, eller gjenstander som er fuktet med brennbare

produkter, inn i eller i nærheten av apparatet.

 **ADVARSEL!**

Fare for skade på produktet.

- For å forhindre skade på emaljen:
 - ikke plasser ovnsutstyr eller andre gjenstander direkte i bunnen av produktet.
 - ikke legg aluminiumsfolie direkte på bunnen av rommet i produktet.
 - ikke tøm vann direkte inn i det varme produktet.
 - ikke oppbevar fuktig servise eller mat i produktet når tilberedningen er ferdig.
 - vær forsiktig når du fjerner eller monterer tilbehøret.
- Misfarge på produktets emalje eller rustfritt stål har ingen innvirkning på funksjonen.
- Bruk en grill-/stekepanne for bløte kaker. Fruktsaft gir permanente flekker.
- Tilbered alltid med produktets dør lukket.
- Hvis produktet er montert bak et møbeldør, må du sørge for at døren aldri er lukket når produktet er i drift. Varme og fuktighet kan bygge seg opp bak et lukket møbeldør og dermed forårsake skade på apparatet, boligen eller gulvet. Ikke lukk møbeldøren før produktet er helt avkjølt etter bruk.

2.4 Stell og rengjøring

 **ADVARSEL!**

Risiko for skade, brann eller skade på produktet.

- Slå av apparatet og trekk støpselet ut av stikkkontakten før rengjøring og vedlikehold.
- Påse at produktet er kaldt. Det er fare for at glasspanelene kan knuses.
- Erstatt umiddelbart panelene til glassdørene om disse har blitt skadet. Kontakt det autoriserte servicesenteret.
- Vær forsiktig når du fjerner døren fra produktet. Døren er tung!

- Rengjør apparatet med jevne mellomrom for å forhindre skade på overflaten.
- Rengjør apparatet med en fuktet myk klut. Bruk kun nøytralt vaskemiddel. Bruk ikke slipeprodukter, slipende rengjøringsputer, løsemidler eller metallobjekter.
- Følg sikkerhetsanvisningene på pakken hvis du bruker ovnspray.

2.5 Innvendig lys

 **ADVARSEL!**

Fare for elektrisk støt.

- Angående lampen(e) i dette produktet og reservedeler som selges separat: Disse lampene er ment å motstå ekstreme fysiske forhold i husholdningsprodukter, for eksempel temperatur, vibrasjon, fuktighet, eller er ment å signalisere informasjon om produktets driftsstatus. De er ikke ment å brukes i andre bruksområder og egner seg ikke til rombelysning.
- Dette produktet inneholder en lyskilde med energieffektivitetsklasse G.
- Bruk kun lyspærer med tilsvarende spesifikasjoner.

2.6 Tjenester

- Kontakt det autoriserte servicesenteret for å reparere apparatet.
- Bruk kun originale reservedeler.

2.7 Avfallshåndtering

 **ADVARSEL!**

Fare for skade og kvelning.

- Kontakt kommunen din for informasjon om hvordan du kaster apparatet.
- Koble produktet fra strømmen.
- Kutt av strømkabelen, lukk produktet og kast den.
- Fjern dørlåsen for å forhindre at barn, eller kjæledyr kan bli innestengt i apparatet.

3. PRODUKTBEKRIVELSE

3.1 Generell oversikt

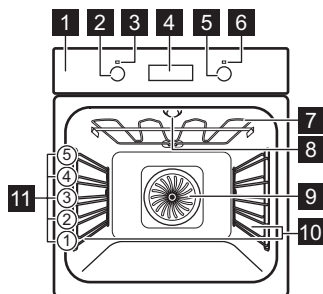

- 1 Betjeningspanel
- 2 Bryter for ovnsfunksjoner
- 3 Strømindikator/-symbol
- 4 Display
- 5 Betjeningsbryter (for temperaturen)
- 6 Temperaturindikator/-symbol
- 7 Varmeelement
- 8 Lys
- 9 Vifte
- 10 Uttakbare brettstiger
- 11 Hyllenivåer

3.2 Tilbehør

Rist

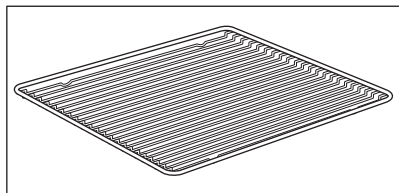

For kokekar, kakeformer, steker.

Stekebrett

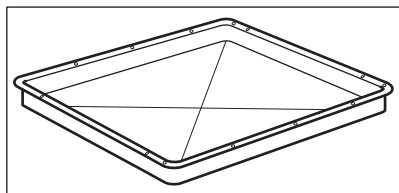

For kaker og kjeks.

Grill-/stekepanne

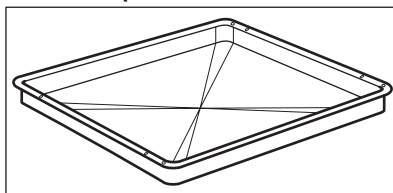

For å bake eller steke eller for å samle opp fett.

4. BETJENINGSPANEL

4.1 Skjult lås

For å bruke produktet, trykker du på bryteren. Bryteren kommer ut.

4.2 Sensor felt / Knapper

—	For å stille inn tiden.
	For å stille inn en klokkefunksjon.
+	For å stille inn tiden.

4.3 Display

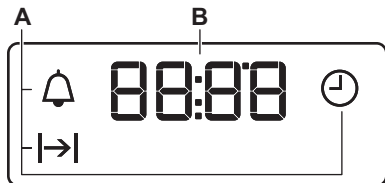

- A. Klokkefunksjoner
- B. Timer

5. FØR FØRSTEGANGS BRUK

ADVARSEL!

Se etter i Sikkerhetskapitlene.

5.1 Før førstegangs bruk

Ovnen kan avgi lukt og røyk under forvarming. Sørg for tilstrekkelig ventilasjon i rommet.



Steg 1



Steg 2



Steg 3



Still klokken

1. **+**, **—** – trykk for å stille inn tiden. Etter ca. 5 s stopper blinkingen og displayet viser klokkeslett.

Rengjør ovnen

1. Ta ut all tilbehør og avtakbare brettstiger fra ovnen.
2. Rengjør ovne og tilbehøret kun med en mikrofiberklut, varmt vann og et mildt vaskemiddel.

Forvarm den tomme ovnen

1. Velg maksimumstemperaturen for funksjonen: .
Tid: 1 t.
2. Velg maksimumstemperaturen for funksjonen: .
Tid: 15 min.

Slå ovnen av, og vent til det er kaldt. Sett tilbehøret og de avtakbare hyllestøttene i ovnen.

6. DAGLIG BRUK





ADVARSEL!



Se etter i Sikkerhetskapitlene.

6.1 Slik stiller du inn: Varmefunksjon

Steg 1	Drei på knappen for varmfunksjonene for å velge en ovnsfunksjonene.
Steg 2	Drei på kontrollvelgeren for å velge temperaturen.
Steg 3	Når steking er ferdig, drei bryterne til av-posisjonen for å slå av ovnen.

6.2 Ovnsfunksjoner

Varmefunksjon	Anvendelse
	Ovnen er av.
Av-posisjon	
	Slik slår du på lampen.
Lys	
	Slik baker du på opptil tre hylle-nivåer samtidig og tørker mat. Juster temperaturen 20 °C - 40 °C lavere enn ved Over- og undervarme.
Steking – ekte varmluft	
	Slik steker du pizza. For å opp-nå en mer intens bruning og sprø bunn.
Pizzafunksjon	
	For å bake og steke på ett hylle-nivå.
Over- og undervarme	
	For å hermetisere mat og bake kaker med sprø bunn.
Undervarme	
	For å tine mat (grønnsaker og frukt). Tinetiden avhenger av mengden og størrelsen på den frosne maten.
Tining	

Varmefunksjon	Anvendelse
	Denne funksjonen er laget med tanke på å spare energi når man lager mat. Når du bruker denne funksjonen, kan temperaturen i ovnsrommet variere fra den angitte temperaturen. Restvarmen brukes. Varmeeffekten kan reduseres. For mer informasjon, se kapitlet «Daglig bruk», merknader om: Baking med fukt.
Baking med fukt	
	Slik griller du tynne matstykker og rister brød.
Grill	
	For å steke store kjøttstykker eller fjærfe på én brett plassering. For å gratinere og brune.
Gratinering med vifte	

 Lampen blir automatisk slått av ved en temperatur under 60 °C for enkelte ovnsfunksjoner.

6.3 Merknader på: Baking med fukt



Denne funksjonen blir brukt til å overholde energieffektivitetsklassen og økodesignkrav (i henhold til EU 65/2014 og EU 66/2014). Tester i henhold til: IEC/EN 60350-1.

Stekeovnsdøren skal være lukket under tilberedning slik at funksjonen ikke forstyrres, og ovnen er i drift med høyest mulig energieffektivitet.

For matlagingsinstruksjonene se kapitlet «Råd og tips», Baking med fukt. For generelle anbefalinger om energisparing se kapitlet «Energieffektivitet», Energisparing.

7. KLOKKEFUNKSJONER



7.1 Klokkefunksjoner

Klokkefunksjon	Bruksområde
 Tid på dagen	For å stille inn, endre eller se hva klokken er.
 Varighet	For å velge hvor lenge ovnen virker.
 Varselur	For innstilling av varseluret. Denne funksjonen har ingen innvirkning på bruken av stekeovnen. Du kan innstille denne funksjonen når som helst, selv når ovnen er slått av.

7.2 Slik stiller du inn: Klokkefunksjonene



Slik stiller du inn: Tid på dagen

 - blinker når du kobler ovnen til en strømkilde, etter et strømbrydd eller hvis tidsuret ikke er stilt inn.

 ,  – trykk for å stille inn tiden.
Etter ca. 5 sek stopper blinkingen og displayet viser klokkeslett.



Slik endrer du: Tid på dagen





Steg 1  – trykk gjentatte ganger for å endre klokkeslettet.  – begynner å blinke.

Steg 2  ,  – trykk for å stille inn tiden.
Etter ca. 5 sek stopper blinkingen og displayet viser klokkeslett.

Slik stiller du inn: Varighet

Steg 1 Innstill en ovnsfunksjon og temperaturen.



Steg 2  – trykk gjentatte ganger.  – begynner å blinke.

Steg 3  ,  – trykk for å stille inn varighet.
Displayet viser: 
 - blinker når innstilt tid går ut. Signalet høres og ovnen slår seg av.

Steg 4 Trykk på en vilkårlig knapp for å stoppe signalet.

Steg 5 Drei bryterne til av-stillingen.

Slik stiller du inn: Varselur

Steg 1  – trykk gjentatte ganger.  – begynner å blinke.

Slik stiller du inn: Varselur

Steg 2 **+**, **—** – trykk for å stille inn tiden.
Funksjonen starter automatisk etter 5 sekunder.
Når innstilt tid avsluttes, hører du et lydsignal.

Steg 3 Trykk på en vilkårlig knapp for å stoppe signalet.

Steg 4 Drei bryterne til av-stillingen.

Slik avbryter du: Klokkefunksjonene

Steg 1  – trykk gjentatte ganger til klokkesymbolet begynner å blinke.

Steg 2 Trykk og hold inne: **—**.
Klokkefunksjonen slås av etter noen få sekunder.

8. BRUKE TILBEHØRET

ADVARSEL!

Se etter i Sikkerhetskapitlene.

8.1 Innsetting av tilbehør

Små fordypninger øverst for å øke sikkerheten. Fordypningene er også

tippebeskyttet. Den høye kanten rundt risten forhindrer at kokekar sklir av risten.

Rist:

Sett ristene inn mellom sporene på brettstigen.

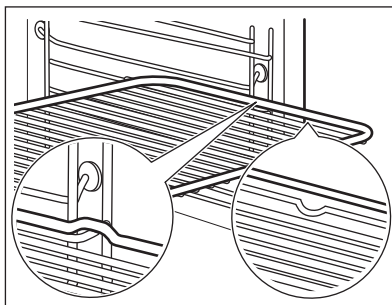

Stekebrett / Langpanne:

Skvy brettet inn i sporene på brettstigene.

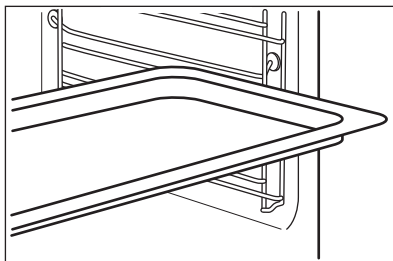

9. TILLEGGSFUNKSJONER

9.1 Kjølevifte

Når produktet er i bruk, slår kjøleviften seg på automatisk for å holde produktets overflater

kalde. Hvis du slår av produktet, er kjøleviften aktiv til produktet avkjøles.

10. HJELP OG TIPS



Se etter i Sikkerhetskapitlene.

10.1 Råd om tilberedning



Temperaturer og steketider i tabellene er kun veiledende. De avhenger av oppskriftene og kvalitet og mengde ingredienser som brukes.

Produktet ditt kan muligens bake eller steke på en annen måte enn det gamle produktet ditt gjorde. Antydningene nedenfor viser anbefalte innstillinger for temperatur, tilberedningstid og hylleplassering for spesifikke mattyper. Hvis du ikke finner opplysningene for en spesiell oppskrift, kan du ta utgangspunkt i en tilsvarende rett.

10.2 Steking av bakst

Still inn lavere temperatur ved første baking.

Steketiden kan forlenges med 10 – 15 minutter dersom du steker kaker i flere høyder.

Kaker og bakverk med forskjellige høyde brunes ikke alltid likt. Det er ikke nødvendig å





skifte temperaturinnstilling ved ujevn bruning. Forskjellene utjevnes under steking.

Stekebrettene i ovnen kan vri seg under steking. Når stekebrettene er kalde igjen, får de tilbake sin opprinnelige form.

10.3 Baketips

Bakeresultater	Mulig årsak	Løsning
Bunnen av kaken har ikke brunet seg nok.	Brett plasseringen er feil.	Sett kaken på en lavere ovnsrille.
Kaken faller sammen og blir klissete eller randete.	Temperaturen i ovnen er for høy.	Senk ovnstemperaturen litt neste gang.
	Ovnstemperaturen er for høy og steketiden er for kort.	Velg lengre steketid og senk ovnstemperaturen neste gang.
Kaken er for tørr.	Ovnstemperaturen er for lav.	Øk ovnstemperaturen neste gang.
	For lang steketid.	Velg kortere steketid neste gang.
Kaken stekes ujevnt.	Ovnstemperaturen er for høy og steketiden er for kort.	Velg lengre steketid og senk ovnstemperaturen neste gang.
	Kakedeigen er ikke jevnt fordelt.	Spre kakedeigen jevnt på stekebrettet neste gang.
Kaken er ikke ferdig etter den angitte steketiden i oppskriften.	Ovnstemperaturen er for lav.	Øk ovnstemperaturen litt neste gang.



10.4 Baking i én høyde



 BAKING I FORMER		 (°C)	 (min)	
Gratengbase – mørdeig, forvarm den tomme ovnen	Steking – ekte varmluft	170 – 180	10 – 25	2
Gratengbase – formkakemiks	Steking – ekte varmluft	150 – 170	20 – 25	2
Tysk ringkake / Brioche	Steking – ekte varmluft	150 – 160	50 – 70	1
Madeirakake / Fruktkaker	Steking – ekte varmluft	140 – 160	70 – 90	1
Ostkake	Over- og undervarme	170 – 190	60 – 90	1

Bruk det tredje hyllenivået.

Bruk funksjonen: Steking – ekte varmluft.

Bruk et stekebrett.





 KAKER / BAKVERK / BRØD	 (°C)	 (min)
Myk kake med strøtopping	150 – 160	20 – 40

 KAKER / BAKVERK / BRØD	 (°C)	 (min)
Fruktkake (av gjærdeig / formkakemiks), bruk en langpanne	150	35 – 55
Fruktkake lagd av mørdeig	160 – 170	40 – 80





Forvarm tom stekeovn.





Bruk funksjonen: Over- og undervarme.

Bruk et stekebrett.

 KAKER / BAKVERK / BRØD	 (°C)	 (min)	
Rullekake	180 – 200	10 – 20	3
Rugbrød:	først: 230	20	1
	så: 160 – 180	30 – 60	
Smurt mandelkake / Sukkerbrød	190 – 210	20 – 30	3
Vannbakkels / Eclairs	190 – 210	20 – 35	3
Flettebrød / Brødkrone	170 – 190	30 – 40	3
Fruktkake (av gjærdeig / formkakemiks), bruk en langpanne	170	35 – 55	3
Gjærkaker med delikat fyll (f.eks. kvarg, krem, vaniljesaus)	160 – 180	40 – 80	3
Christstollen	160 – 180	50 – 70	2





Bruk det tredje hyllnivået.

 KAKEBUNNER		 (°C)	 (min)
Mørdeigkjeks	Steking – ekte varmluft	150 – 160	10 – 20
Rundstykker, forvarm den tomme ovnen	Steking – ekte varmluft	160	10 – 25
Lett bløtkakebunn av sukkerbrødmiks	Steking – ekte varmluft	150 – 160	15 – 20
Butterdeig, forvarm den tomme ovnen	Steking – ekte varmluft	170 – 180	20 – 30
Lett bløtkakebunn av gjærdeig	Steking – ekte varmluft	150 – 160	20 – 40

 KAKEBUNNER		 (°C)	 (min)
Makroner	Steking – ekte varmluft	100 – 120	30 – 50
Butterdeig av eggehvite / Marrengs	Steking – ekte varmluft	80 – 100	120 – 150
Rundstykker, forvarm den tomme ovnen	Over- og undervarme	190 – 210	10 – 25

10.5 Gryteretter/grateng





Bruk det første hyllenivået.





		 (°C)	 (min)
Baguetter toppet med smeltet ost	Steking – ekte varmluft	160 – 170	15 – 30
Grønnsaksgrateng, forvarm den tomme ovnen	Gratinerer med vifte	160 – 170	15 – 30
Lasagne	Over- og undervarme	180 – 200	25 – 40
Fiskeretter i form	Over- og undervarme	180 – 200	30 – 60
Fylte grønnsaker	Steking – ekte varmluft	160 – 170	30 – 60
Søt bakst	Over- og undervarme	180 – 200	40 – 60
Pasta ovnsretter	Over- og undervarme	180 – 200	45 – 60

10.6 Steking i flere høyder

Bruk funksjonen: Steking – ekte varmluft.

Bruk stekebrettene.

 KAKER/ BAKVERK	 (°C)	 (min)	 2 posisjoner
Vannbakkels / Eclairs, forvarm den tomme ovnen	160 – 180	25 – 45	1 / 4
Tørr Tosca kake	150 – 160	30 – 45	1 / 4

 KJEKS / SMÅKAKER / BAKVERK / RUNDSTYKKER	 (°C)	 (min)		
			2 posisjoner	3 posisjoner
Rundstykker	180	20 – 30	1 / 4	-
Mørdeigkjeks	150 – 160	20 – 40	1 / 4	1 / 3 / 5
Lett bløtkakebunn av sukkerbrødmiks	160 – 170	25 – 40	1 / 4	-
Butterdeig, forvarm den tomme ovnen	170 – 180	30 – 50	1 / 4	-
Lett bløtkakebunn av gjærdeig	160 – 170	30 – 60	1 / 4	-
Makroner	100 – 120	40 – 80	1 / 4	-
Lett bløtkakebunn av eggehvite / Marengs	80 – 100	130 – 170	1 / 4	-

10.7 Tips for steking

Bruk varmebestandig ovnsutstyr.

Tildekket mager stek (du kan bruke aluminiumsfolie).

Stek store steker rett på brettet.

Legg litt vann i brettet for å unngå at dryppende fett svir.

Snu steken etter 1/2-2/3 av tilberedningstiden.





Stek kjøtt og fisk i store stykker (1 kg eller mer).

Hvis nivå 1 foreslås, legger du ingrediensen rett på stekebrettet

Pensle kjøttstykker med egne safter flere ganger under steking.

10.8 Steking

Bruk det første hyllenivået.

 STORFEKJØTT			 (°C)	 (min)
Grytestek	1 - 1,5 kg	Over- og undervarme	230	120 - 150
Roastbiff eller filet, rå, forvarm den tomme ovnen	per cm tykkelse	Gratinerings med vifte	190 - 200	5 - 6
Roastbiff eller filet, medium, forvarm den tomme ovnen	per cm tykkelse	Gratinerings med vifte	180 - 190	6 - 8



STORFEKJØTT



(°C)



(min)

Roastbiff eller filet, godt stekt, forvarm den tomme ovnen

per cm tykkelse

Gratinerer med vifte

170 - 180

8 - 10



SVINEKJØTT



Bruk funksjonen: Gratinerer med vifte.



(kg)



(°C)



(min)

Skulder / Nakke / Skinkestek

1 - 1.5

160 - 180

90 - 120

Koteletter / Ribbestek

1 - 1.5

170 - 180

60 - 90

Kjøttpudding

0.75 - 1

160 - 170

50 - 60

Svineknoke, forhåndskokt

0.75 - 1

150 - 170

90 - 120



KALVEKJØTT



Bruk funksjonen: Gratinerer med vifte.



(kg)



(°C)



(min)

Kalvestek

1

160 - 180

90 - 120

Kalveknoke

1.5 - 2

160 - 180

120 - 150



LAMMEKJØTT



Bruk funksjonen: Gratinerer med vifte.



(kg)



(°C)



(min)

Lammelår / Lammestek

1 - 1.5

150 - 170

100 - 120

Lammesadel

1 - 1.5

160 - 180

40 - 60



SMÅVILT



Bruk funksjonen: Over- og undervarme.



(kg)



(°C)



(min)

Sadel / Harelår, forvarm den tomme ovnen

opp til 1

230

30 - 40

Viltsadel

1.5 - 2

210 - 220

35 - 40

Lårstykke av hjort

1.5 - 2

180 - 200

60 - 90



FJÆRKRE



Bruk funksjonen: Gratinerer med vifte.



(kg)



(°C)



(min)

Stykker av fjærkre

0,2 - 0,25 hver

200 - 220

30 - 50

Kylling, delt i to

0.4 - 0.5 hver

190 - 210

35 - 50

Kylling, poulard

1 - 1.5

190 - 210

50 - 70

And

1.5 - 2

180 - 200

80 - 100

Gås

3.5 - 5

160 - 180

120 - 180

Kalkun

2.5 - 3.5

160 - 180

120 - 150

Kalkun

4 - 6

140 - 160

150 - 240



FISK (DAMPET)



Bruk funksjonen: Over- og undervarme.



(kg)



(°C)



(min)

Hel fisk

1 - 1.5

210 - 220

40 - 60

10.9 Sprø bakst med: Pizzafunksjon



PIZZA



Bruk det første hyllnivået.



(°C)



(min)

Terte

180 - 200

40 - 55

Spinatpai

160 - 180

45 - 60

Quiche Lorraine / Sveitsisk pai

170 - 190

45 - 55

Ostkake

140 - 160

60 - 90

Grønnsakspai

160 - 180

50 - 60



PIZZA



Forvarm tom stekeovn før tilberedning.



Bruk det andre hyllnivået.



(°C)



(min)

Pizza, tynn bunn, bruk en langpanne

200 - 230

15 - 20



PIZZA



Forvarm tom stekeovn før tilberedning.



Bruk det andre hyllnivået.



(°C)



(min)

Pizza, tykk bunn

180 - 200

20 - 30

Usyret brød

230 - 250

10 - 20

Butterdeig grating

160 - 180

45 - 55

Flammekake

230 - 250

12 - 20

Piroger

180 - 200

15 - 25

10.10 Grill

Forvarm tom stekeovn før tilberedning.

Grill kun tynne stykker av kjøtt eller fisk.

Plasser en panne på det første hyllnivået for å ta i mot fett.



GRILL



Bruk funksjonen: Grill



(°C)



(min)
1. side



(min)
2. side



	(°C)	(min) 1. side	(min) 2. side	
Roastbiff	210 - 230	30 - 40	30 - 40	2
Oksefilet	230	20 - 30	20 - 30	3
Svinekam	210 - 230	30 - 40	30 - 40	2
Kalvekam	210 - 230	30 - 40	30 - 40	2
Lammesadel	210 - 230	25 - 35	20 - 25	3
Hel fisk, 0,5 kg - 1 kg	210 - 230	15 - 30	15 - 30	3 / 4

10.11 Frossen mat



AVRIMING



Bruk funksjonen: Steking – ekte varmluft.



(°C)



(min)



	(°C)	(min)	
Frossen pizza	200 - 220	15 - 25	2
Frossen Panpizza	190 - 210	20 - 25	2
Avkjølt pizza	210 - 230	13 - 25	2
Pizzabiter, frosne	180 - 200	15 - 30	2
Pommes frites, tynne	200 - 220	20 - 30	3
Pommes frites, tykke	200 - 220	25 - 35	3
Kiler / Croquetter	220 - 230	20 - 35	3
Reven potetgrateng	210 - 230	20 - 30	3
Lasagne / Cannelloni, fersk	170 - 190	35 - 45	2
Lasagne / Cannelloni, frossen	160 - 180	40 - 60	2
Bakt ost	170 - 190	20 - 30	3
Kyllingvinger	190 - 210	20 - 30	2





10.12 Tining

Ta av innpakningen og legg maten på en tallerken.

Dekk ikke til maten, ettersom dette kan forlenge opptiningstiden.

Bruk det første stigettrinnet.

Sett et brett opp ned inn i bunnen av ovensrommet ved tilberedning av store mengder. Sett maten i en dyp form og plasser den oppå brettet i ovnen. Fjern stigene dersom det er nødvendig.

	 (kg)	 (min.) Opptiningstid	 (min.) Ytterlige opptiningstid	
Kylling	1	100 – 140	20 – 30	Snu etter halve steketiden.
Kjøtt	1	100 – 140	20 – 30	Snu etter halve steketiden.
Ørret	0,15	25 – 35	10 – 15	-
Jordbær	0,3	30 – 40	10 – 20	-
Smør	0,25	30 – 40	10 – 15	-
Krem	2 x 0,2	80 – 100	10 – 15	Pisk kremen mens den fremdeles er litt frossen.
Gateau	1,4	60	60	-

10.13 Hermetisering

Bruk funksjonen Undervarme.

Bruk kun konserveringsglass med samme størrelse.

Ikke bruk glass med skrulokk eller bajonettlokk eller metallbokser.

Bruk det første hyllenivået.

Ikke sett mer enn seks en liters konserveringsglass på stekebrettet.





Fyll krukkene like mye og lukk med en klemme.



Glassene skal ikke berøre hverandre.

Fyll ca. 1/2 liter vann på stekebrettet slik at det dannes tilstrekkelig med fuktighet i stekeovnen.

Når væsken i krukkene så vidt begynner å koke (etter ca. 35-60 minutter for enlitorskrukker), slår du av stekeovnen eller reduserer temperaturen til 100 °C (se tabellen).

Still temperaturen til 160 – 170 °C.

 MYK FRUKT	 (min) Koketid inntil småkoking	
Jordbær / Blåbær / Bringebær / Modne stikkelsbær	35 – 45	
 FRUKT MED KJERNE	 (min) Koketid inntil småkoking	 (min) Fortsett å koke ved 100 °C
Fersken / Kveder / Plommer	35 – 45	10 – 15

 GRØNNSA- KER	 (min) Koketid inn- til småko- king	 (min) Fortsett å koke ved 100 °C
Gulrøtter	50 – 60	5 – 10
Agurk	50 – 60	-
Blandede grønn- saker	50 – 60	5 – 10
Kålraabi / Erter / Asparges	50 – 60	15 – 20

10.14 Tørking - Steking – ekte varmluft

Dekk til brettene med bakepapir eller bakepapir.

For bedre resultat, stopp ovnen halvveis i tørketiden, åpne døren og avkjøl i én natt for å fullføre tørkingen.

Bruk det tredje hyllnivået for ett brett.

For 2 brett bruker du første og fjerde hyllnivå.

10.15 Baking med fukt – anbefalt tilbehør

Bruk mørke og ikke-refleksive bokser og beholderen. De har bedre varmeabsorbering enn den lette fargen og de refleksive rettene.



Pizzapanne

Mørk, ikke-reflekterende
28 cm diameter

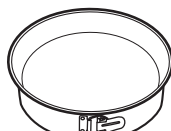

Kakeform

Mørk, ikke-reflekterende
26 cm diameter



Ramekins

Keramisk
8 cm diameter, 5
cm høyde

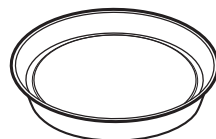



Form for karamellpud-
ding



Mørk, ikke-reflekterende
28 cm diameter





10.16 Baking med fukt

Følg forslagene i tabellen for best mulig resultater.

 GRØNNSA- KER	 (°C)	 (t)
Bønner	60–70	6–8
Paprika	60–70	5–6
Grønnsaker til suppe	60–70	5–6
Sopp	50–60	6–8
Urter	40–50	2–3

Still temperaturen til 60 - 70 °C.





 FRUKT	 (t)
Plommer	8–10
Aprikos	8–10
Epleskiver	6–8
Pærer	6–9

	 (°C)	 (min)	
Brødpinner, 0,5 kg totalt	190 - 200	50 - 60	3
Bakte kamskjell i skjell	180 - 200	30 - 40	4
Hel fisk i salt, 0,3 - 0,5 kg	190 - 200	45 - 50	4
Hel fisk innpakket, 0,3 - 0,5 kg	190 - 200	50 - 60	3
Amaretti (20; 0,5 kg totalt)	170 - 180	40 - 50	3
Smuldrepai med eple	190 - 200	50 - 60	4
Sjokolademuffins (20; 0,5 kg totalt)	160 - 170	35 - 45	3

10.17 Informasjon for testinstitutter





Tester i henhold til: EN 60350, IEC 60350.

Baking i én høyde – baking i former





		 °C	 min	
Fettfritt formkake	Steking – ekte varmluft	160	45 - 60	2
Fettfritt formkake	Over- og undervarme	160	45 - 60	2
Elepai, 2 former Ø 20 cm	Steking – ekte varmluft	160	55 - 65	2
Elepai, 2 former Ø 20 cm	Over- og undervarme	180	55 - 65	1
Kjeks	Steking – ekte varmluft	140	25 - 35	2
Kjeks	Over- og undervarme	140	25 - 35	2

Baking i én høyde – kjeks

Bruk det tredje hyllevivået.

		 °C	 min
Småkaker, 20 stk. per stekebrett, forvarm den tomme ovnen	Steking – ekte varmluft	150	20 - 30
Småkaker, 20 stk. per stekebrett, forvarm den tomme ovnen	Over- og undervarme	170	20 - 30





Baking i flere høyder – kjeks

		 °C	 min	
Kjeks	Steking – ekte varmluft	140	25 - 45	2 / 4
Småkaker, 20 stk. per stekebrett, forvarm den tomme ovnen	Steking – ekte varmluft	150	25 - 35	1 / 4
Fettfritt formkake	Steking – ekte varmluft	160	45 - 55	2 / 4
Elepai, 1 boks per rist (Ø 20 cm)	Steking – ekte varmluft	160	55 - 65	2 / 4

Grill

Forvarm den tomme ovnen i 5 minutter.

Grill med maksimum temperaturinnstilling.

		 min	
Smørbrød	Grill	1 - 2	5
Storfestek, snu halvveis	Grill	24 - 30	4

11. STELL OG RENGJØRING

ADVARSEL!

Se etter i Sikkerhetskapitlene.

11.1 Merknader om rengjøring



Rengjøringsmidler

Rengjør produktets forside kun med en mikrofiberklut med varmt vann og et mildt vaskemiddel.

Bruk en rengjøringsløsning for å rengjøre metalloverflater.

Rengjør flekker med et mildt vaskemiddel.



Hverdagsbruk

Rengjør ovnsrommet etter bruk. Fettoppsamling eller andre rester kan føre til brann.

Ikke oppbevar maten i produktet lenger enn 20 minutter. Tørk ovnsrommet kun med en mikrofiberklut etter hver bruk.



Rengjør alt tilbehør etter hver bruk og la det tørke. Bruk kun en mikrofiberklut med varmt vann og et mildt vaskemiddel. Ikke rengjør tilbehøret i en oppvaskmaskin.

Rengjør ikke tilbehør med slippbelegg med sterke vaskemidler eller skarpe gjenstander.

Tilbehør

11.2 Slik fjerner du: Gyllestøtter

Fjern brettstignene for å rengjøre ovnen.

Steg 1 Slå av ovnen og vent til den har kjølt seg ned.

Steg 2 Trekk den fremre delen av ovnsstigen ut fra sideveggen.

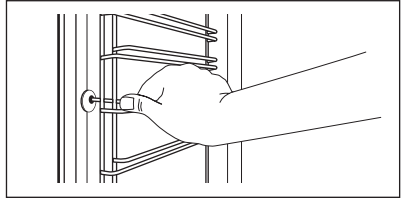

Steg 3 Trekk den bakre delen av hyllestøtten ut fra sideveggen og ta den ut.

Steg 4 Monter hyllestøttene i motsatt rekkefølge.

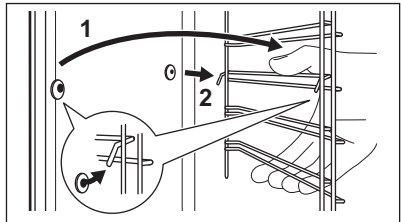

11.3 Slik fjerner du: Grill

ADVARSEL!

Fare for brannskader.

Steg 1 Slå ovnen av, og vent til den er kald for å rengjøre den. Fjern brettstignene.

Steg 2 Ta tak i grillhjørnene. Trekk det fremover mot fjærtrykket og ut av de to holderne. Grillen foldes ned.

Steg 3 Rengjør stekeovnstaket med lunkent vann, en myk klut og et skånsomt rengjøringsmiddel. La tørke.

Steg 4 Monter grillen i omvendt rekkefølge.

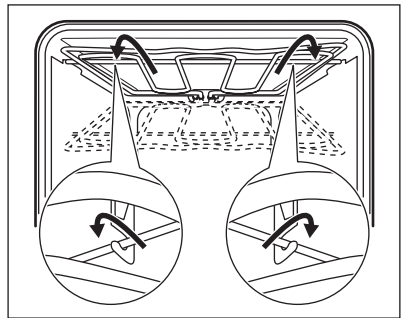

Steg 5 Monter brettstignene.

11.4 Slik fjerner og monterer du: Dør

Du kan fjerne døren og det indre glasspanelet for å rengjøre det. Antall glass er forskjellig for ulike modeller.

⚠ ADVARSEL!

Døren er tung.

⚠ FORSIKTIG!

Håndter glasset forsiktig, særlig på kantene på frontpanelet. Glasset kan knuse.

Steg 1 Åpne døren helt.

Steg 2 Løft og trykk klemmefestene (A) på begge dørhengslene.

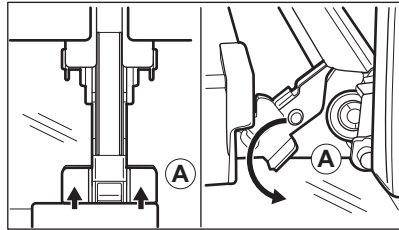

Steg 3 Lukk døren til første åpneposisjon (ved tilnærmet 70° vinkel). Hold ovnsdøren i begge sider og trekk den ut og opp fra ovnen. Legg døren med utsiden ned på et mykt og stabilt underlag.

Steg 4 Hold dørlisten (B) øverst på døren på begge sider og trykk innover for å frigjøre klipslåsen.

Steg 5 Trekk dørlisten mot deg for å fjerne den.

Steg 6 Hold et og et glass øverst i kanten og trekk dem oppover og ut av føringsringen.

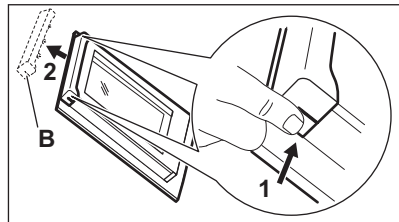

Steg 7 Rengjør glasspanelet med såpe og vann. Tørk glasspanelet grundig. Ikke rengjør glasspanelene i oppvaskmaskinen.

Steg 8 Gjenta stegene ovenfor i motsatt rekkefølge etter rengjøring.

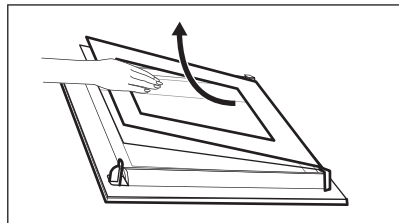

Steg 9 Monter det minste panelet først, så det store, og til slutt døren. Kontroller at glassene er satt inn og ligger i riktig posisjon, ellers kan overflaten på døren overopphetes.

11.5 Slik bytter du: Ovnslampe

⚠ ADVARSEL!

Fare for elektrisk støt.
Lampen kan være varm.

Før du skifter pæren:

Steg 1

Slå av ovnen. Vent til ovnen er avkjølt.

Steg 2

Koble fra strømtilførselen til ovnen.

Steg 3

Legg en klut på bunnen i ovnsrommet.

Øverste ovnslampe

Steg 1 Drei glassdekselet for å ta det av.

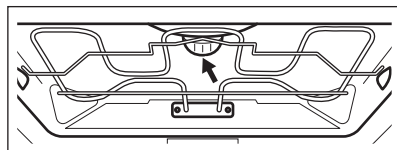

Steg 2 Rengjør glassdekselet.

Steg 3 Erstatt pæren med en egnet varmebestandig lyspære som tåler 300 °C.

Steg 4 Monter glassdekselet.

12. FEILSØKING

ADVARSEL!

Se etter i Sikkerhetskapitlene.

12.1 Hva må gjøres, hvis...

Itilfeller som ikke er inkludert i denne tabellen, ta kontakt med et autorisert servicesenter.

Problem	Kontroller at...
Ovnen blir ikke varm.	Sikringen har gått.
Displayet viser «12.00».	Det var strømbrydd. Angi tid på dagen.
Lampen fungerer ikke.	Lyspæren har gått.

12.2 Servicedata

Hvis du ikke greier å løse problemet selv, kontakter du forhandleren eller et autorisert servicesenter.

Du finner informasjon som servicesenteret behøver på typeskiltet. Typeskiltet er plassert på den fremre rammen til produktrommet. Ikke fjern typeskiltet fra produktrommet.

Vi anbefaler at du noterer opplysningene her:

Modell (MOD.)

Produktnummer (PNC)

Serienummer (S.N.)

13. ENERGIEFFEKTIV

13.1 Produktinformasjon og produktinformasjonsark i henhold til EU-forordninger om økodesign og energimerking

Leverandørens navn	AEG	
Modellidentifikasjon	BEK435060B 944188455 EB40B 944188534	
Energieffektivitetsindeks	81,2	
Energieffektivitetsklasse	A+	
Energiforbruk med standard matmengde, over- og undervarme	0,99kWh/syklus	
Energiforbruk med standardbelastning, viftemodus	0,69kWh/syklus	
Antall ovner	1	
Varmekilde	Elektrisitet	
Volum	71l	
Ovnstyper	Innebygd ovn	
Masse	BEK435060B	33.0kg
	EB40B	33.0kg

EN 60350-1 - Elektriske husholdningsapparater for matlaging – del 1: Sortiment, ovner, dampovner og griller – metoder for måling av ytelse.

13.2 Energisparing



Produktet har noen funksjoner som hjelper deg å spare energi under vanlig matlaging.

Sørg for at produktets dør er lukket når produktet er i bruk. Ikke åpne produkt døren for ofte under matlaging. Hold dørpakningen ren og sørg for at den sitter godt på plass.

Bruk kokekar i metall for å øke energisparingen.

Når det er mulig skal du ikke forvarme produktet før matlaging.

Hold pausene mellom steking så kort som mulig når du lager flere retter om gangen.

Tilberedning med varmluft

Bruk om mulig tilberedningsfunksjoner med varmluft for å spare strøm.

Restvarme

Når tilberedningstiden er lengre enn 30 min, reduser produktets temperatur til minimum 3 - 10 min før matlagingen avsluttes. Restvarmen inne i produktet fortsetter å tilberede.

Bruk restvarmen til å varme opp andre retter.

Sluk holder du maten varm

Hvis du vil bruke restvarmen til å holde måltidet varmt, velg lavest mulig temperaturinnstilling.

Baking med fukt

Funksjonen er laget med tanke på å spare strøm under matlaging.

14. BESKYTTELSE AV MILJØET

Resirkuler materialer som er merket med symbolet . Legg emballasjen i riktige beholdere for å resirkulere det. Bidrar til å beskytte miljøet, menneskers helse og for å resirkulere avfall av elektriske og elektroniske produkter. Ikke kast produkter som er merket

med symbolet  sammen med husholdningsavfallet. Produktet kan leveres der hvor tilsvarende produkt selges eller på miljøstasjonen i kommunen. Kontakt kommunen for nærmere opplysninger.

PARA UNOS RESULTADOS PERFECTOS

Gracias por elegir este producto AEG. Lo hemos creado para brindarle un rendimiento impecable durante muchos años, con tecnologías innovadoras que lo ayudan a simplificar la vida, características que quizás no encuentre en los electrodomésticos comunes. Dedique unos minutos a leer este documento para sacarle el máximo partido.

Visite nuestro sitio web para:



Obtener consejos, folletos, soluciones a problemas e información de servicio y reparación:

www.aeg.com/support



Registrar su producto para recibir un mejor servicio:

www.registreaeg.com



Comprar accesorios, artículos de consumo y piezas de recambio originales para su aparato:

www.aeg.com/shop

ATENCIÓN AL CLIENTE Y SERVICIO

Le recomendamos que utilice recambios originales.

Cuando se ponga en contacto con nuestro Centro de servicio técnico, asegúrese de tener los siguientes datos disponibles: Modelo, código numérico del producto (PNC), número de serie.

La información se encuentra en la placa de características.

 Advertencia / Precaución - Información sobre seguridad

 Información general y consejos

 Información relativa al medioambiente

Salvo modificaciones.

CONTENIDO

1. INFORMACIÓN SOBRE SEGURIDAD.....	233
2. INSTRUCCIONES DE SEGURIDAD.....	235
3. DESCRIPCIÓN DEL PRODUCTO.....	238
4. PANEL DE MANDOS.....	238
5. ANTES DEL PRIMER USO.....	239
6. USO DIARIO.....	240
7. FUNCIONES DEL RELOJ.....	241
8. USO DE LOS ACCESORIOS.....	242
9. FUNCIONES ADICIONALES.....	243
10. CONSEJOS.....	243
11. MANTENIMIENTO Y LIMPIEZA.....	255
12. SOLUCIÓN DE PROBLEMAS.....	258
13. EFICACIA ENERGÉTICA.....	259
14. ASPECTOS MEDIOAMBIENTALES.....	260

1. ⚠ INFORMACIÓN SOBRE SEGURIDAD

Antes de instalar y utilizar el aparato, lea atentamente las instrucciones facilitadas. El fabricante no se hace responsable de lesiones o daños producidos como resultado de una instalación o un uso incorrectos. Conserve siempre estas instrucciones en lugar seguro y accesible para futuras consultas.

1.1 Seguridad de niños y personas vulnerables

- Este aparato puede ser utilizado por niños de 8 años en adelante y personas cuyas capacidades físicas, sensoriales o mentales estén disminuidas o que carezcan de la experiencia y conocimientos suficientes para manejarlo, siempre que cuenten con las instrucciones o la supervisión sobre el uso del electrodoméstico de forma segura y comprendan los riesgos. Es necesario mantener alejados del aparato a los niños de menos de 8 años, así como a las personas con minusvalías importantes y complejas, salvo que estén bajo supervisión continua.
- Es necesario vigilar a los niños para que no jueguen con el aparato.
- Mantenga todo el material de embalaje fuera del alcance de los niños y deséchelo de forma adecuada.
- **ADVERTENCIA:** El horno y las piezas accesibles se calientan mucho durante el funcionamiento. Mantenga a los niños y las mascotas alejados del aparato cuando esté en uso y cuando se enfríe.
- Si este aparato tiene un bloqueo de seguridad para niños, debe activarlo.
- La limpieza y mantenimiento de usuario del producto no podrán ser realizados por niños sin supervisión.

1.2 Instrucciones generales de seguridad

- Este aparato está diseñado exclusivamente para cocinar.

- Este aparato está diseñado para uso doméstico en interiores.
- Este aparato se puede utilizar en oficinas, habitaciones de hotel, habitaciones de Bed&Breakfast, casas de campo y otros alojamientos similares donde dicho uso no exceda (en promedio) los niveles de uso doméstico.
- Solo un electricista cualificado puede instalar este aparato y sustituir el cable.
- No utilice el aparato antes de instalarlo en la estructura empotrada.
- Desenchufe el aparato de la red eléctrica antes de realizar tareas de mantenimiento.
- Si el cable de alimentación presenta algún daño, el fabricante, su servicio técnico autorizado o un profesional tendrán que cambiarlo para evitar riesgos.
- **ADVERTENCIA:** Asegúrese de que el aparato está apagado antes de cambiar la bombilla para evitar el riesgo de descarga eléctrica.
- **ADVERTENCIA:** El horno y las piezas accesibles se calientan mucho durante el funcionamiento. Debe tener cuidado para evitar tocar los elementos de calentamiento o la superficie del interior del aparato.
- Utilizar siempre guantes o manoplas para horno para retirar o introducir accesorios o recipientes.
- Para retirar los carriles de apoyo, tire primero del frontal del carril y, a continuación, separe el extremo trasero de las paredes laterales. Instale los carriles de apoyo en el orden inverso.
- No utilice un limpiador a vapor para limpiar el aparato.
- No utilice productos de limpieza abrasivos ásperos ni rascadores de metal afilado para limpiar el cristal de las tapas abisagradas de la placa si no quiere arañar su superficie, lo que podría hacer que el cristal se hiciese añicos.

2. INSTRUCCIONES DE SEGURIDAD

2.1 Instalación

ADVERTENCIA!

Sólo un técnico cualificado puede instalar el aparato.

- Retire todo el embalaje.
- No instale ni utilice un aparato dañado.
- Siga las instrucciones de instalación suministradas con el aparato.
- Tenga cuidado al mover el aparato, porque es pesado. Utilice siempre guantes de protección y calzado cerrado.
- No tire nunca del aparato sujetando el asa.
- Instale el aparato en un lugar seguro y adecuado que cumpla los requisitos de instalación.
- Respete siempre la distancia mínima entre el aparato y los demás electrodomésticos y mobiliario.
- Antes de montar el aparato, compruebe si la puerta se abre sin limitaciones.
- El aparato está equipado con un sistema de refrigeración eléctrica. Debe utilizarse con la fuente de alimentación eléctrica.
- La unidad empotrada debe cumplir los requisitos de estabilidad de la norma DIN 68930.

Altura mínima del armario (Altura mínima del armario debajo de la encimera)	578 (600) mm
Ancho del armario	560 mm
Profundidad del armario	550 (550) mm
Altura de la parte frontal del aparato	594 mm
Altura de la parte trasera del aparato	576 mm
Anchura de la parte frontal del aparato	595 mm
Anchura de la parte trasera del aparato	559 mm
Fondo del aparato	567 mm
Fondo empotrado del aparato	546 mm

Fondo con la puerta abierta	1027 mm
Tamaño mínimo de la abertura de ventilación. Abertura situada en la parte trasera inferior	560x20 mm
Longitud del cable de alimentación. El cable está en la esquina derecha de la parte trasera	1500 mm
Tornillos de montaje	4x25 mm

2.2 Conexión eléctrica

ADVERTENCIA!

Riesgo de incendios y descargas eléctricas.

- Todas las conexiones eléctricas deben realizarlas electricistas cualificados.
- El aparato debe conectarse a tierra.
- Asegúrese de que los parámetros de la placa de características son compatibles con los valores eléctricos del suministro eléctrico.
- Utilice siempre una toma con aislamiento de conexión a tierra correctamente instalada.
- No utilice adaptadores de enchufes múltiples ni cables prolongadores.
- Asegúrese de no provocar daños en el enchufe ni en el cable de red. Si es necesario cambiar el cable de alimentación del aparato, debe hacerlo el centro de servicio técnico autorizado.
- Evite que el cable de red toque o entre en contacto con la puerta del aparato o con el hueco por debajo del aparato, especialmente mientras funciona o si la puerta está caliente.
- Los mecanismos de protección contra descargas eléctricas de componentes con corriente y aislados deben fijarse de forma que no puedan aflojarse sin utilizar herramientas.
- Conecte el enchufe a la toma de corriente únicamente cuando haya terminado la instalación. Asegúrese de tener acceso al

enchufe del suministro de red una vez finalizada la instalación.

- Si la toma de corriente está floja, no conecte el enchufe.
- No desconecte el aparato tirando del cable de conexión a la red. Tire siempre del enchufe.
- Use únicamente dispositivos de aislamiento apropiados: línea con protección contra los cortocircuitos, fusibles (tipo tornillo que puedan retirarse del soporte), dispositivos de fuga a tierra y contactores.
- La instalación eléctrica debe tener un dispositivo de aislamiento que permita desconectar el aparato de todos los polos de la red. El dispositivo de aislamiento debe tener una apertura de contacto con una anchura mínima de 3 mm.
- El aparato se suministra con enchufe y cable de red.

2.3 Uso

ADVERTENCIA!

Riesgo de lesiones, quemaduras y descargas eléctricas o explosiones.

- No cambie las especificaciones de este aparato.
- Asegúrese de que las aberturas de ventilación no están bloqueadas.
- No deje el aparato desatendido durante el funcionamiento.
- Apague el aparato después de cada uso.
- Tenga cuidado al abrir la puerta del aparato mientras funciona. Puede liberarse aire caliente.
- No utilice el aparato con las manos mojadas ni con agua en contacto.
- No ejerza presión sobre la puerta abierta.
- No utilice el aparato como superficie de trabajo ni para depositar objetos.
- Abra la puerta del aparato con cuidado. El uso de ingredientes con alcohol puede provocar una mezcla de alcohol y aire.
- No deje que las chispas ni las llamas abiertas entren en contacto con el aparato cuando abra la puerta.
- No coloque productos inflamables o artículos mojados con productos inflamables dentro, cerca o sobre el aparato.

ADVERTENCIA!

Podría dañar el aparato.

- Para evitar daños o decoloraciones en el esmalte:
 - no coloque recipientes ni otros objetos directamente en la base.
 - no coloque papel de aluminio directamente en la parte inferior del interior del aparato.
 - no ponga agua directamente en el aparato caliente.
 - no deje platos húmedos ni alimentos en el aparato una vez finalizada la cocción.
 - tenga cuidado al retirar o instalar los accesorios.
- La pérdida de color del esmalte o el acero inoxidable no afecta al rendimiento del aparato.
- Utilice una bandeja honda para pasteles húmedos. Los jugos de las frutas provocan manchas permanentes.
- Cocina siempre con la puerta del aparato cerrada.
- Si el aparato se instala detrás de un panel de un mueble (por ejemplo una puerta) asegúrese de que la puerta nunca esté cerrada mientras funciona el aparato. El calor y la humedad pueden acumularse detrás de un panel del armario cerrado y provocar daños al aparato, el alojamiento o el suelo. No cierre del panel del armario hasta que el aparato se haya enfriado completamente después de su uso.

2.4 Mantenimiento y limpieza

ADVERTENCIA!

Existe riesgo de lesiones, incendios o daños al aparato.

- Antes de proceder con el mantenimiento, apague el aparato y desconecte el enchufe de la red.
- Asegúrese de que el aparato esté frío. Los paneles de cristal pueden romperse.
- Cambie inmediatamente los paneles de cristal de la puerta que estén dañados. Póngase en contacto con el servicio técnico autorizado.

- Tenga cuidado al desmontar la puerta del aparato. ¡La puerta es muy pesada!
- Limpie periódicamente el aparato para evitar el deterioro del material de la superficie.
- Limpie el aparato con un paño suave humedecido. Utilice solo detergentes neutros. No utilice productos abrasivos, estropajos duros, disolventes ni objetos metálicos.
- Si utiliza aerosoles de limpieza para hornos, siga las instrucciones de seguridad del envase.

2.5 Iluminación interna

ADVERTENCIA!

Riesgo de descarga eléctrica.

- En cuanto a la(s) bombilla(s) de este producto y las de repuesto vendidas por separado: Estas bombillas están destinadas a soportar condiciones físicas extremas en los aparatos domésticos, como la temperatura, la vibración, la humedad, o están destinadas a señalar información sobre el estado de funcionamiento del aparato. No están destinadas a utilizarse en otras aplicaciones y no son adecuadas para la iluminación de estancias domésticas.

- Este producto contiene una fuente luminosa de la clase de eficiencia energética G.
- Utilice solo bombillas de las mismas características .

2.6 Asistencia técnica

- Para reparar el aparato, póngase en contacto con el centro de servicio autorizado.
- Utilice solamente piezas de recambio originales.

2.7 Eliminación

ADVERTENCIA!

Existe riesgo de lesiones o asfixia.

- Contacte con las autoridades locales para saber cómo desechar correctamente el aparato.
- Desconecte el aparato de la red.
- Corte el cable eléctrico cerca del aparato y deséchelo.
- Retire el pestillo de la puerta para evitar que los niños o las mascotas queden atrapados en el aparato.

3. DESCRIPCIÓN DEL PRODUCTO

3.1 Resumen general

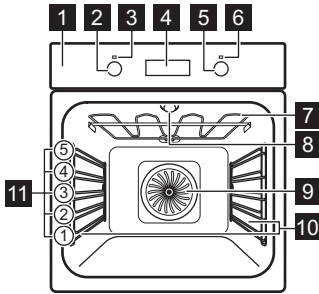

- 1 Panel de mandos
- 2 Mando de las funciones de cocción
- 3 Piloto/símbolo de alimentación
- 4 Programador electrónico
- 5 Mando de control (para la temperatura)
- 6 Indicador/símbolo de temperatura
- 7 Resistencia
- 8 Bombilla
- 9 Ventilador
- 10 Soporte de parrilla extraíble
- 11 Posiciones de las parrillas

3.2 Accesorios

Parrilla

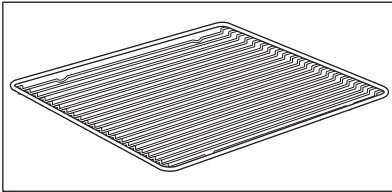

Para utensilios de cocina, moldes de pastelería, asados.

Bandeja

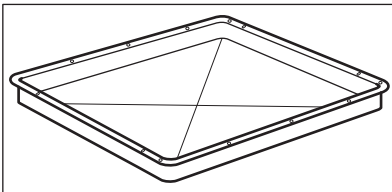

Para bizcochos y galletas.

Parrilla/sartén para asar

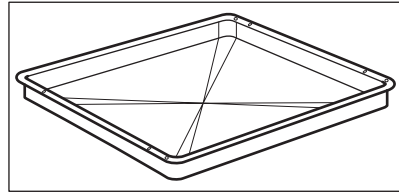

Para hornear y asar o como bandeja para grasa.

4. PANEL DE MANDOS

4.1 Mandos escamoteables

Para usar el aparato, presione el mando. El mando sale del alojamiento.

4.2 Sensores / botones

—	Para ajustar la hora.
	Para ajustar una función de reloj.
+	Para ajustar la hora.

4.3 Pantalla

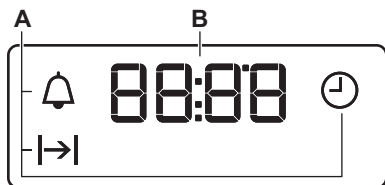

- A. Funciones del reloj
- B. Temporizador

5. ANTES DEL PRIMER USO

ADVERTENCIA!

Consulte los capítulos sobre seguridad.

5.1 Antes del primer uso

El horno puede emitir olores y humos durante el precalentamiento. Asegúrese de que la sala esté ventilada.



Paso 1



Paso 2



Paso 3



Ajuste el reloj

- pulse **+**, **—** para ajustar la hora. Después de unos 5 segundos, el parpadeo cesa y la pantalla indica la hora ajustada.

Limpie el horno

1. Retire todos los accesorios del horno y carriles laterales extraíbles del horno.
2. Limpie el horno y los accesorios solo con un paño de microfibra humedecido en agua tibia y detergente suave.

Precalente el horno vacío

1. Seleccione la temperatura máxima para la función: . Tiempo: 1 h.
2. Seleccione la temperatura máxima para la función: . Tiempo: 15 min.

Apague el horno y espere a que esté frío. Coloque los accesorios y carriles de apoyo extraíbles en el horno.

6. USO DIARIO







ADVERTENCIA!





Consulte los capítulos sobre seguridad.

6.1 Cómo configurar: Función de cocción

- Paso 1** Gire el mando del horno para seleccionar una función de cocción.
- Paso 2** Gire el mando de control para seleccionar la temperatura.
- Paso 3** Al terminar la cocción, gire los mandos hasta la posición de apagado para apagar el horno.

6.2 Funciones de cocción

Función de cocción	Aplicación
	El horno está apagado.
Posición de apagado	
	Para encender la luz.
Luz	
	Para hornear en hasta tres posiciones de parrilla a la vez y para secar alimentos. Ajuste la temperatura entre 20 y 40 °C menos que para Cocción convencional.
Aire caliente	
	Para hornear pizza. Para obtener un dorado más intenso y una base más crujiente.
Función pizza	
	Para hornear y asar alimentos en una posición de parrilla.
Cocción convencional	
	Para hornear pasteles con base crujiente y conservar alimentos.
Calor inferior	

Función de cocción	Aplicación
	Para descongelar alimentos (verduras y frutas). El tiempo de descongelación depende de la cantidad y el tamaño de los alimentos congelados.
Descongelar	
	Función diseñada para ahorrar energía durante la cocción. Cuando se utiliza esta función, la temperatura del horno puede diferir de la temperatura programada. Se utiliza el calor residual. La potencia calorífica puede reducirse. Para más información, consulte el capítulo "Uso diario", Notas sobre: Horneado húmedo + ventil.
Horneado húmedo + ventil.	
	Para asar al grill alimentos de poco espesor y tostar pan.
Grill	
	Asado con aire caliente para piezas de carne más grandes o aves con hueso en un nivel. Para gratinar y dorar.
Grill turbo	



La bombilla se puede desactivar automáticamente a temperaturas inferiores a 60 °C durante algunas funciones del horno.

6.3 Notas sobre la función Moist Fan: Horneado húmedo + ventil.



Esta función se utilizaba para cumplir con los requisitos de eficiencia energética y diseño ecológico (según EU 65/2014 y EU 66/2014). Pruebas según: IEC/EN 60350-1.

La puerta del horno debe estar cerrada durante la cocción para que no se interrumpa la función y el horno funcione con la máxima eficiencia energética posible.

Consulte las instrucciones de cocción en el capítulo "Consejos", Horneado húmedo + ventil..Para recomendaciones generales sobre ahorro energético, consulte el capítulo "Eficiencia energética", Ahorro energético.

7. FUNCIONES DEL RELOJ

7.1 Funciones del reloj

función de reloj	Aplicación
 Hora	Ajustar, modificar o comprobar la hora.
 Duración	Programar la duración del funcionamiento del horno.
 Avisador	Para configurar una cuenta atrás. Esta función no influye en el funcionamiento del horno. Puede ajustar esta función cualquier momento, incluso si el horno está apagado.

7.2 Cómo ajustar: Funciones de reloj



Cómo ajustar: Hora



 - parpadea al conectar el horno a la corriente eléctrica si ha habido un corte de corriente o si no está ajustado el temporizador.

 ,  - pulsa para ajustar la hora.

Después de unos 5 segundos, el parpadeo cesa y la pantalla indica la hora ajustada.

Cómo cambiar: Hora





Paso 1  - pulsa repetidamente para cambiar la hora del día.  - empieza a parpadear.

Paso 2  ,  - pulsa para ajustar la hora.
Después de unos 5 segundos, el parpadeo cesa y la pantalla indica la hora ajustada.

Cómo ajustar: Duración

Paso 1 Programa una función y una temperatura del horno.

Paso 2  - pulsa repetidamente.  - empieza a parpadear.

Paso 3  ,  - pulsa para fijar la duración.
La pantalla muestra: 
 - parpadea cuando termina la hora ajustada. La señal suena y el horno se apaga.

Paso 4 Pulsa cualquier tecla para detener la señal.

Paso 5 Gira los mandos a la posición de apagado.

Cómo ajustar: Avisador

Paso 1  - pulsa repetidamente.  - empieza a parpadear.

Cómo ajustar: Avisador

Paso 2 **+**, **-** - pulsa para ajustar la hora.
La función empieza automáticamente tras 5 segundos.
Al finalizar el tiempo programado, sonará la señal acústica.

Paso 3 Pulsa cualquier tecla para detener la señal.

Paso 4 Gira los mandos a la posición de apagado.

Instrucciones para cancelar: Funciones de reloj

Paso 1  - pulsa repetidamente hasta que el símbolo de la función de reloj empiece a parpadear.

Paso 2 Mantén pulsado: **—**.
La función de reloj se apaga después de unos segundos.

8. USO DE LOS ACCESORIOS

ADVERTENCIA!

Consulte los capítulos sobre seguridad.

8.1 Inserción de accesorios

Una pequeña muesca en la parte superior aumenta la seguridad. Las hendiduras

también son dispositivos antivuelco. El borde elevado que rodea la bandeja evita que los utensilios de cocina resbalen de la parrilla.

Parrilla:

Inserte la parrilla entre las guías del carril.

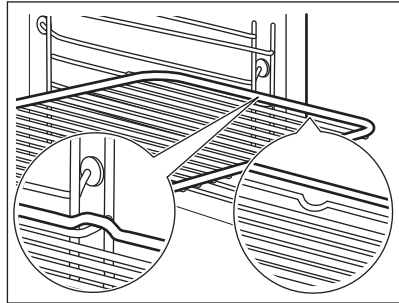

Bandeja / Bandeja honda:

Introduzca la bandeja entre las guías del carril de apoyo.

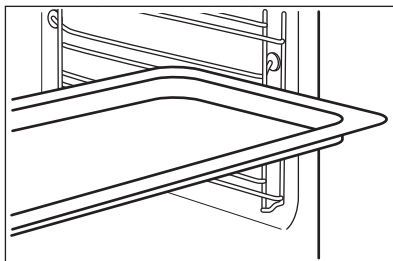

9. FUNCIONES ADICIONALES

9.1 Ventilador de refrigeración

Cuando el aparato está en funcionamiento, el ventilador de enfriamiento se enciende automáticamente para mantener frías sus

superficies. Si apaga el aparato, el ventilador de enfriamiento puede seguir funcionando hasta que se enfríe.

10. CONSEJOS



Consulte los capítulos sobre seguridad.

10.1 Recomendaciones de cocción



La temperatura y los tiempos de cocción de las tablas son meramente orientativos. Dependen de las recetas y de la calidad y cantidad de los ingredientes utilizados.

El aparato puede hornear o asar de forma diferente del aparato que tenía anteriormente. Las siguientes sugerencias muestran los ajustes recomendados para la temperatura, el tiempo de cocción y la posición de los estantes para tipos de alimentos concretos.

Si no encuentra los ajustes para una receta especial, busque otra similar.

10.2 Horneado

Para la primera cocción, utilice la temperatura más baja.

El tiempo de cocción puede ampliarse unos 10-15 minutos cuando se hornea repostería en más de una posición.

Los pasteles y las pastas que se hornean a niveles diferentes no siempre se doran de





modo uniforme. No es necesario cambiar el ajuste de temperatura si el tueste no es uniforme. Las diferencias se compensarán durante el horneado.

Las bandejas pueden torcerse en el horno durante el horneado. Las distorsiones desaparecen cuando las bandejas se enfrían de nuevo.

10.3 Consejos para hornear

Resultado	Posible causa	Solución
La base de la tarta no se ha horneado lo suficiente.	La parrilla no está en una posición correcta.	Coloque la tarta en un nivel más bajo.
La tarta se hunde y se queda pegajosa o muestra estrías.	La temperatura del horno es demasiado alta.	La próxima vez ajuste una temperatura del horno ligeramente más baja.
	La temperatura del horno es demasiado alta y el tiempo de cocción demasiado corto.	La próxima vez fije un tiempo de horneado más largo y baje la temperatura del horno.
La tarta está demasiado seca.	La temperatura del horno es demasiado baja.	La próxima vez ajuste una temperatura del horno más alta.
	El tiempo de horneado es demasiado largo.	La próxima vez fije un tiempo de horneado más corto.
El pastel se hornea irregularmente.	La temperatura del horno es demasiado alta y el tiempo de cocción demasiado corto.	La próxima vez fije un tiempo de horneado más largo y baje la temperatura del horno.
	La masa del pastel no se distribuye uniformemente.	La próxima vez, distribuya la masa uniformemente en la bandeja.
El pastel no está listo en el tiempo indicado en la receta.	La temperatura del horno es demasiado baja.	La próxima vez ajuste una temperatura del horno un poco más alta.



10.4 Horneado en un solo nivel

 ALI- MENTOS EN MOLDES		 (°C)	 (min)	
Masa brisé - masa quebrada, precalentado el horno vacío	Aire caliente	170 - 180	10 - 25	2
Masa brisé - mezcla de bizcocho	Aire caliente	150 - 170	20 - 25	2
Molde redondo / Brioche	Aire caliente	150 - 160	50 - 70	1
Tarta de Madeira / Tarta de frutas	Aire caliente	140 - 160	70 - 90	1
Tarta de queso	Cocción convencional	170 - 190	60 - 90	1

Use el tercer nivel.

Use la función: Aire caliente.





Utilice una bandeja de horno.

 TARTAS / PASTAS / PANES	 (°C)	 (min)
Pastel de azúcar	150 - 160	20 - 40
Tarta de frutas (sobre masa con levadura / bizcocho), utilice una bandeja honda	150	35 - 55
Tarta de fruta sobre masa quebrada	160 - 170	40 - 80





Precalente el horno vacío.





Use la función: Cocción convencional.

Utilice una bandeja de horno.

 TARTAS / PASTAS / PANES	 (°C)	 (min)	
Brazo de gitano	180 - 200	10 - 20	3
Pan de centeno:	primero: 230 después: 160 - 180	20 30 - 60	1
Tarta de almendras y mantequilla / Tartas de azúcar	190 - 210	20 - 30	3
Buñuelos de crema / Bollitos rellenos de crema	190 - 210	20 - 35	3
Trenza de pan / Roscón	170 - 190	30 - 40	3
Tarta de frutas (sobre masa con levadura / bizcocho), utilice una bandeja honda	170	35 - 55	3
Bizcochos con levadura coronados de guarniciones delicadas (por ejemplo, requesón, crema, natillas)	160 - 180	40 - 80	3
Pastel de navidad	160 - 180	50 - 70	2





Use el tercer nivel.

 GALLETAS		 (°C)	 (min)
Galletas de masa quebrada	Aire caliente	150 - 160	10 - 20
Rollitos, precalente el horno vacío	Aire caliente	160	10 - 25

 GALLETAS		 (°C)	 (min)
Galletas de masa batida esponjosa	Aire caliente	150 - 160	15 - 20
Hojaldres de hojaldre, precaliente el horno vacío	Aire caliente	170 - 180	20 - 30
Galletas de masa de levadura	Aire caliente	150 - 160	20 - 40
Mostachones de almendra	Aire caliente	100 - 120	30 - 50
Galletas de clara de huevo / Merengues	Aire caliente	80 - 100	120 - 150
Rollitos, precaliente el horno vacío	Cocción convencional	190 - 210	10 - 25

10.5 Gratinados y horneados





Use el primer nivel.





		 (°C)	 (min)
Baguette cubierta de queso fundido	Aire caliente	160 - 170	15 - 30
Verduras gratinadas, precaliente el horno vacío	Grill turbo	160 - 170	15 - 30
Lasaña	Cocción convencional	180 - 200	25 - 40
Pescado al horno	Cocción convencional	180 - 200	30 - 60
Verduras rellenas	Aire caliente	160 - 170	30 - 60
Dulces horneados	Cocción convencional	180 - 200	40 - 60
Pastel de pasta	Cocción convencional	180 - 200	45 - 60

10.6 Horneado en varios niveles

Use la función: Aire caliente.

Utilice las bandejas de horno.

 TARTAS / PASTAS	 (°C)	 (min)	 2 posiciones
Buñuelos de crema / Bolleritos rellenos de crema, precaliente el horno vacío	160 - 180	25 - 45	1 / 4
Pastel Streusel seco	150 - 160	30 - 45	1 / 4

 GALLETAS/PASTELLOS/PASTAS/BOLLOS	 (°C)	 (min)		
			2 posiciones	3 posiciones
Rollitos	180	20 - 30	1 / 4	-
Galletas de masa quebrada	150 - 160	20 - 40	1 / 4	1 / 3 / 5
Galletas de masa batida esponjosa	160 - 170	25 - 40	1 / 4	-
Hojaldres de hojaldre, precaliente el horno vacío	170 - 180	30 - 50	1 / 4	-
Galletas de masa de levadura	160 - 170	30 - 60	1 / 4	-
Mostachones de almendra	100 - 120	40 - 80	1 / 4	-
Galletas de clara de huevo / Merengues	80 - 100	130 - 170	1 / 4	-

10.7 Consejos para asar

Use utensilios para horno resistentes al calor.

Ase la carne magra tapada (puede utilizar papel de aluminio).

Ase juntas las porciones grandes de carne directamente en la bandeja.

Para evitar que se queme la grasa, ponga un poco de agua en la bandeja.

Gire el asado al cabo de 1/2 o 2/3 del tiempo de cocción.





Ase trozos de carne y pescado grandes (1 kg o más).

Si se sugiere el nivel uno, ponga la comida directamente en la bandeja

Durante la cocción, los asados grandes se deben rociar repetidamente con el jugo.

10.8 Asados

Use el primer nivel.

 CARNE DE RES				
				
			(°C)	(min)
Estofado	1 - 1,5 kg	Cocción convencional	230	120 - 150
Rosbif o filete, poco hecho, precaliente el horno vacío	por cm de grosor	Grill turbo	190 - 200	5 - 6



CARNE DE RES



(°C)



(min)

Rosbif o filete, al punto, precaliente el horno vacío

por cm de grosor

Grill turbo

180 - 190

6 - 8

Rosbif o filete muy hecho, precaliente el horno vacío

por cm de grosor

Grill turbo

170 - 180

8 - 10



CERDO



Use la función: Grill turbo.



(kg)



(°C)



(min)

Paletilla / Cuello / Jamón

1 - 1.5

160 - 180

90 - 120

Chuletas / Costillas

1 - 1.5

170 - 180

60 - 90

Pastel de carne

0.75 - 1

160 - 170

50 - 60

Codillo de cerdo precocinado

0.75 - 1

150 - 170

90 - 120



TERNERA



Use la función: Grill turbo.



(kg)



(°C)



(min)

Ternera asada

1

160 - 180

90 - 120

Codillo de ternera

1.5 - 2

160 - 180

120 - 150



CORDERO



Use la función: Grill turbo.



(kg)



(°C)



(min)

Pata de cordero / Cordero asado

1 - 1.5

150 - 170

100 - 120

Costillar de cordero

1 - 1.5

160 - 180

40 - 60



CARNE DE CAZA



Use la función: Cocción convencional.



(kg)



(°C)



(min)

Silla / Pata de liebre, precaliente el horno vacío

hasta 1

230

30 - 40

Costillar de corzo

1.5 - 2

210 - 220

35 - 40

Pierna de corzo

1.5 - 2

180 - 200

60 - 90



AVES



Use la función: Grill turbo.



(kg)



(°C)



(min)

Aves troceadas

0,2 - 0,25 cada trozo

200 - 220

30 - 50

Pollo, medio

0,4 - 0,5 cada trozo

190 - 210

35 - 50

Pollo, pularda

1 - 1.5

190 - 210

50 - 70

Pato

1.5 - 2

180 - 200

80 - 100

Ganso

3.5 - 5

160 - 180

120 - 180

Pavo

2.5 - 3.5

160 - 180

120 - 150

Pavo

4 - 6

140 - 160

150 - 240



PESCADO (AL VAPOR)



Use la función: Cocción convencional.



(kg)



(°C)



(min)

Pescado entero

1 - 1.5

210 - 220

40 - 60

10.9 Horneado crujiente con: Función pizza



PIZZA



Use el primer nivel.



(°C)



(min)

Tartas

180 - 200 40 - 55

Flan de espinacas

160 - 180 45 - 60

Quiche Lorraine / Flan suizo

170 - 190 45 - 55

Tarta de queso

140 - 160 60 - 90

Pastel de verduras

160 - 180 50 - 60



PIZZA



Precaliente el horno vacío antes de cocinar.



Use el segundo nivel.



(°C)



(min)

Pizza, base fina, utilice una bandeja honda

200 - 230 15 - 20



PIZZA



Precaliente el horno vacío antes de cocinar.



Use el segundo nivel.



(°C)



(min)

Pizza, base gruesa

180 - 200 20 - 30

Pan sin levadura

230 - 250 10 - 20

Empanada de masa de hojaldre

160 - 180 45 - 55

Flammkuchen

230 - 250 12 - 20

Pierogi

180 - 200 15 - 25

10.10 Grill

Precaliente el horno vacío antes de cocinar.

Cocine al grill solo trozos de carne o pescado poco gruesos.

Coloque una bandeja en el primer nivel para recoger la grasa.



GRILL



Use la función: Grill



(°C)



(min)
1ª cara



(min)
2ª cara



	(°C)	(min) 1ª cara	(min) 2ª cara	
Rosbif	210 - 230	30 - 40	30 - 40	2
Solomillo de ternera	230	20 - 30	20 - 30	3
Lomo de cerdo	210 - 230	30 - 40	30 - 40	2
Lomo de ternera	210 - 230	30 - 40	30 - 40	2
Costillar de cordero	210 - 230	25 - 35	20 - 25	3
Pescado entero, 0,5 kg - 1 kg	210 - 230	15 - 30	15 - 30	3 / 4

10.11 Congelados



DESCONGELACIÓN



Use la función: Aire caliente.



(°C)



(min)



	(°C)	(min)	
Pizza congelada	200 - 220	15 - 25	2
Pizza americana congelada	190 - 210	20 - 25	2
Pizza fría	210 - 230	13 - 25	2
Pizzetas congeladas	180 - 200	15 - 30	2
Patatas fritas finas	200 - 220	20 - 30	3
Patatas fritas gruesas	200 - 220	25 - 35	3
Porciones / Croquetas	220 - 230	20 - 35	3
Hash Browns	210 - 230	20 - 30	3
Lasaña / Canelones frescos	170 - 190	35 - 45	2
Lasaña / Canelones congelados	160 - 180	40 - 60	2
Queso al horno	170 - 190	20 - 30	3
Alitas de pollo	190 - 210	20 - 30	2





10.12 Descongelar

Extraiga el alimento del envase y colóquelo en un plato.

No tape la comida, porque puede prolongar el tiempo de descongelación.

Use el primer nivel.

Para grandes porciones de comida, coloque un plato vacío del revés sobre la base en el interior del horno. Coloque la comida en un plato hondo y sobre el plato del interior del horno. Retire los soportes si es necesario.

	 (kg)	 (min) Tiempo de descongelación	 (min) Tiempo de descongelación adicional	
Pollo	1	100 - 140	20 - 30	Dele la vuelta a media cocción.
Carne	1	100 - 140	20 - 30	Dele la vuelta a media cocción.
Trucha	0.15	25 - 35	10 - 15	-
Fresas	0.3	30 - 40	10 - 20	-
Mantequilla	0.25	30 - 40	10 - 15	-
Nata	2 x 0,2	80 - 100	10 - 15	Monte la nata aunque queden puntos ligeramente congelados.
Tarta	1.4	60	60	-

10.13 Conservar

Use la función Calor inferior.

Utilice únicamente botes de conserva del mismo tamaño disponibles en el mercado.

No utilice botes con cierre hermético (twist-off) o de bayoneta ni latas metálicas.

Use el primer nivel.

No coloque más de seis botes de un litro en la bandeja.

Llene los botes por igual y ciérrelos con una abrazadera.



Los botes no se pueden tocar entre sí.



Ponga aproximadamente 1/2 litro de agua en la bandeja de horno para que haya un grado de humedad suficiente en el horno.

Cuando el líquido de los botes comience a formar burbujas (aprox. después de 35 - 60 minutos con frascos de 1 litro), apague el



horno o reduzca la temperatura a 100 °C (consulte la tabla).

Ajuste la temperatura a 160 - 170 °C.

 FRUTAS SIL-VESTRES	 (min) Cocer hasta que empiecen a subir burbujas
Fresas / Arándanos / Frambuesas / Uvas espina maduras	35 - 45

 FRUTA DE HUESO	 (min) Cocer hasta que empiecen a subir burbujas	 (min) Continuar la cocción a 100 °C
--	---	---

Melocotones / Membrillos / Ciruelas	35 - 45	10 - 15
-------------------------------------	---------	---------

 VERDURAS	 (min) Cocer hasta que empiecen a subir burbujas	 (min) Continuar la cocción a 100 °C
--	---	---

Zanahorias	50 - 60	5 - 10
Pepinillos	50 - 60	-
Encurtidos variados	50 - 60	5 - 10
Colinabo / Guisantes / Espárragos	50 - 60	15 - 20

10.14 Desecar alimentos - Aire caliente

Cubra las bandejas con papel vegetal o papel de hornear.

10.15 Horneado húmedo + ventil. - accesorios recomendados

Utilice molde y recipientes oscuros y mates. Tiene mejor absorción del calor que los platos de color claro y brillantes.



Bandeja para pizza

Oscuro, mate
28 cm de diámetro



Bandeja para hornear

Oscuro, mate
26 cm de diámetro



Ramequines

Cerámica
8 cm de diámetro,
5 cm de altura





Molde para base

Oscuro, mate
28 cm de diámetro



Para obtener mejores resultados, apague el horno a la mitad del tiempo de secado, abra la puerta y déjelo enfriar durante una noche para completar el secado.

Para 1 bandeja, use el tercer nivel.

Para 2 bandejas, use el primer y cuarto nivel.





 VERDURAS	 (°C)	 (h)
Judías	60 - 70	6 - 8
Pimientos	60 - 70	5 - 6
Verduras para sopa	60 - 70	5 - 6
Setas	50 - 60	6 - 8
Hierbas	40 - 50	2 - 3

Ajuste de temperatura 60 - 70 °C.

 FRUTA	 (h)
Ciruelas	8 - 10
Albaricoques	8 - 10
Rodajas de manzana	6 - 8
Peras	6 - 9

10.16 Horneado húmedo + ventil.





Para obtener el mejor resultado, siga las recomendaciones de la tabla siguiente.

	 (°C)	 (min)	
Bastoncillos de pan, 0,5 kg en total	190 - 200	50 - 60	3
Vieiras en su concha	180 - 200	30 - 40	4
Pescado entero en sal, 0,3 - 0,5 kg	190 - 200	45 - 50	4
Pescado entero en papel de hornear, 0,3 - 0,5 kg	190 - 200	50 - 60	3
Amaretti (20; 0,5 kg en total)	170 - 180	40 - 50	3
Crumble de manzana	190 - 200	50 - 60	4
Magdalenas de chocolate (20; 0,5 kg en total)	160 - 170	35 - 45	3

10.17 Información para institutos de pruebas





Pruebas según: EN 60350, IEC 60350.





Horneado en un nivel: hornear en moldes

		 °C	 min	
Bizcocho sin grasa	Aire caliente	160	45 - 60	2
Bizcocho sin grasa	Cocción convencional	160	45 - 60	2
Tarta de manzana, 2 moldes, Ø 20 cm	Aire caliente	160	55 - 65	2
Tarta de manzana, 2 moldes, Ø 20 cm	Cocción convencional	180	55 - 65	1
Mantecados	Aire caliente	140	25 - 35	2
Mantecados	Cocción convencional	140	25 - 35	2





Horneado en un nivel: galletas

Use el tercer nivel.

		 °C	 min
Pastelillos, 20 unidades por bandeja, precaliente el horno vacío	Aire caliente	150	20 - 30

		 °C	 min
Pastelillos, 20 unidades por bandeja, precaliente el horno vacío	Cocción convencional	170	20 - 30





Horneado multinivel: galletas

		 °C	 min	
Mantecados	Aire caliente	140	25 - 45	2 / 4
Pastelillos, 20 unidades por bandeja, precaliente el horno vacío	Aire caliente	150	25 - 35	1 / 4
Bizcocho sin grasa	Aire caliente	160	45 - 55	2 / 4
Pastel de manzana, 1 molde por rejilla (Ø 20 cm)	Aire caliente	160	55 - 65	2 / 4

Grill

Precaliente el horno vacío durante 5 minutos.

Grill con la temperatura ajustada al máximo.

		 min	
Tostadas	Grill	1 - 2	5
Bistec de vacuno, dar la vuelta a media cocción	Grill	24 - 30	4

11. MANTENIMIENTO Y LIMPIEZA

ADVERTENCIA!

Consulte los capítulos sobre seguridad.

11.1 Notas sobre la limpieza



Agentes limpiadores

Limpie la parte frontal del aparato solo con un paño de microfibra humedecido en agua tibia y detergente suave.

Utilice un producto de limpieza para limpiar las superficies metálicas.

Limpie las manchas con un detergente suave.



Uso diario

Limpie el interior después de cada uso. La acumulación de grasa u otros residuos puede provocar un incendio.

No guarde la comida en el aparato más de 20 minutos. Seque la cavidad solo con un paño de microfibra después de cada uso.



Accesorios

Limpie todos los accesorios después de cada uso y déjelos secar. Use solo un paño suave humedecido en agua tibia y detergente suave. No lave los accesorios en el lavavajillas.

Evite limpiar los accesorios antiadherentes con limpiadores abrasivos u objetos afilados.

11.2 Cómo quitar: Carriles de apoyo

Para limpiar el horno, retire los carriles de apoyo.

Paso 1 Apague el horno y espere a que esté frío.

Paso 2 Tire de la parte delantera del carril de apoyo para separarlo de la pared lateral.

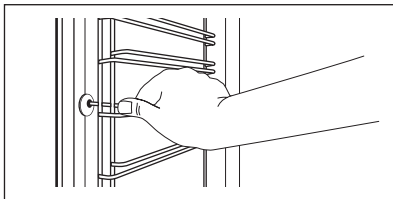

Paso 3 Tire del extremo trasero del carril de apoyo para separarlo de la pared y extráigalo.

Paso 4 Instale los carriles de apoyo en el orden inverso.

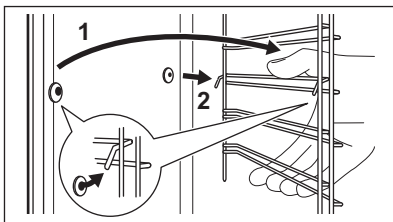

11.3 Cómo quitar: Grill

ADVERTENCIA!

Existe riesgo de quemaduras.

Paso 1 Apague el horno y espere a que esté frío para limpiarlo.
Retire los carriles telescópicos.

Paso 2 Sujete las esquinas de la parrilla. Tire hacia fuera hasta sentir la presión del muelle y extraiga de los dos soportes. El grill se separa del techo por la parte delantera.

Paso 3 Limpie el techo del horno con agua templada, un paño suave y detergente suave. Deje que se seque.

Paso 4 Instale el grill siguiendo el orden inverso.

Paso 5 Coloque los carriles de apoyo.

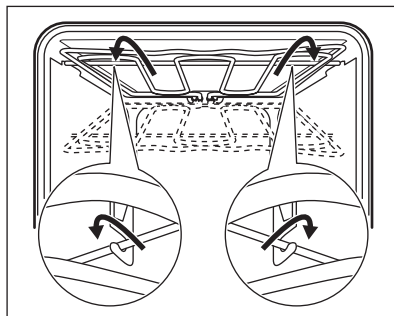

11.4 Cómo quitar e instalar: Puerta

Es posible retirar la puerta del horno y los paneles de cristal interiores para limpiarlos. El número de paneles de cristal es diferente según los modelos.

ADVERTENCIA!

La puerta es pesada.

PRECAUCIÓN!

Maneje con cuidado el cristal, especialmente alrededor de los bordes del panel frontal. El cristal puede romperse.

Paso 1 Abra la puerta por completo.

Paso 2 Levante y presione al máximo las palancas de bloqueo (A) de ambas bisagras de la puerta.

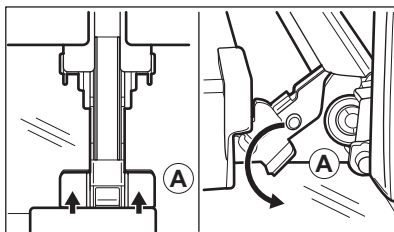

Paso 3 Cierre la puerta del horno hasta la primera posición de apertura (aproximadamente a un ángulo de 70°). Sostenga la puerta con una mano a cada lado y tire de ella hacia arriba y hacia afuera. Ponga la puerta con el lado exterior hacia abajo sobre un paño suave en una superficie nivelada.

Paso 4 Sujete el marco de la puerta (B) por el borde superior de la puerta por ambos lados y empuje hacia dentro para soltar el cierre.

Paso 5 Tire del borde del acabado de la puerta hacia delante para desengancharla.

Paso 6 Sujete uno tras otro los paneles de cristal de la puerta por su borde superior y extraígalos de la guía.

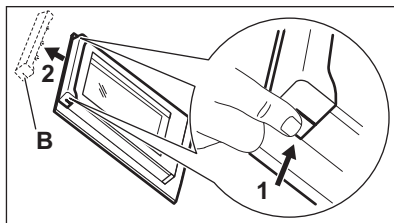

Paso 7 Limpie el panel de cristal con agua y jabón. Seque el panel de cristal con cuidado. No limpie los paneles de cristal en el lavavajillas.

Paso 8 Tras la limpieza, lleve a cabo los pasos anteriores en orden inverso.

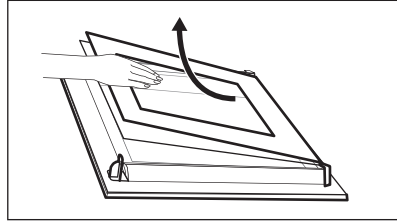

Paso 9 Introduzca primero el panel más pequeño y luego el de mayor tamaño y la puerta. Asegúrese de que los cristales se introducen en la posición correcta para evitar el sobrecalentamiento de la superficie de la puerta.

11.5 Cómo cambiar: Bombilla

ADVERTENCIA!

Riesgo de descarga eléctrica.
La lámpara puede estar caliente.

Antes de reemplazar la bombilla:

Paso 1	Paso 2	Paso 3
Apague el horno. Espere hasta que el horno esté frío.	Desconecte el horno de la red.	Coloque un paño en el fondo de la cavidad.

Bombilla superior

Paso 1 Gire la tapa de cristal para extraerla.

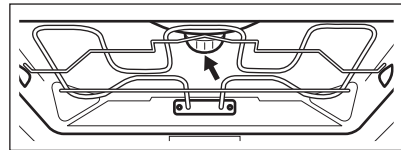

Paso 2 Limpie la tapa de cristal.

Paso 3 Cambie la bombilla por otra apropiada termorresistente hasta 300 °C.

Paso 4 Instale la tapa de cristal.

12. SOLUCIÓN DE PROBLEMAS

ADVERTENCIA!

Consulte los capítulos sobre seguridad.

12.1 Qué hacer si...

En cualquier caso no incluido en esta tabla, por favor contacte con un Centro de Servicio Autorizado.

Problema	Compruebe que...
El horno no se calienta.	Ha saltado el fusible.
La pantalla muestra "12.00".	Se ha producido un corte de corriente. Ajuste la hora.

Problema	Compruebe que...
La bombilla no funciona.	La bombilla se ha fundido.

12.2 Datos de servicio

Si no logra subsanar el problema, póngase en contacto con su distribuidor o un centro de servicio técnico autorizado.

Los datos que necesita para el Centro de servicio técnico se encuentran en la placa de características. La placa de características se encuentra en el marco delantero del interior del aparato. No retire la placa de características de la cavidad del aparato.

Se recomienda escribir los datos aquí:

Modelo (MOD):

Número de producto (PNC)

Número de serie (S.N.)

13. EFICACIA ENERGÉTICA

13.1 Información del producto y ficha de información del producto conforme a la normativa de la UE sobre etiquetado energético y diseño ecológico

Nombre del proveedor	AEG	
Identificación del modelo	BEK435060B 944188455 EB40B 944188534	
Índice de eficiencia energética	81.2	
Clase de eficiencia energética	A+	
Consumo de energía con una carga estándar, modo convencional	0.99kWh/ciclo	
Consumo de energía con una carga estándar, modo de ventilador forzado	0.69kWh/ciclo	
Número de cavidades	1	
Fuente de energía	Electricidad	
Volumen	71l	
Tipo de horno	Horno empotrable	
Masa	BEK435060B	33.0kg
	EB40B	33.0kg

IEC/EN 60350-1 - Aparatos electrodomésticos de cocción - Parte 1: Gamas, hornos, hornos de vapor y grills - Métodos de medida del rendimiento.

13.2 Ahorro energético



El aparato tiene características que le ayudan a ahorrar energía durante la cocina de cada día.

Asegúrese de que la puerta del aparato esté cerrada cuando esté en funcionamiento. No abra la puerta del aparato muchas veces durante la cocción. Mantenga limpia la junta de la puerta y asegúrese de que está bien fijada en su posición.

Utilice utensilios de cocina de metal para mejorar el ahorro energético.

No precaliente el aparato antes de cocinar en la medida de lo posible.

Reduzca al máximo el tiempo entre horneados cuando prepare varios platos de una vez.

Cocción con ventilador

En la medida de lo posible, utilice las funciones de cocción con ventilador para ahorrar energía.

Calor residual

Para una duración de la cocción superior a 30 minutos, reduzca la temperatura del aparato un mínimo de 3 a 10 minutos antes de llegar al final de la cocción. El calor residual dentro del aparato hará que la comida se siga cocinando.

Utilice el calor residual para calentar otros platos.

Mantener calientes los alimentos

Si desea utilizar el calor residual para mantener calientes los alimentos, seleccione el ajuste de temperatura más bajo posible.

Horneado húmedo + ventil.

Función diseñada para ahorrar energía durante la cocción.

14. ASPECTOS MEDIOAMBIENTALES

Recicle los materiales con el símbolo . Coloque el material de embalaje en los contenedores adecuados para su reciclaje. Ayude a proteger el medio ambiente y la salud pública, así como a reciclar residuos de aparatos eléctricos y electrónicos. No

deseche los aparatos marcados con el símbolo  junto con los residuos domésticos. Lleve el producto a su centro de reciclaje local o póngase en contacto con su oficina municipal.

FÖR PERFEKTA RESULTAT

Tack för att du valt denna AEG-produkt. Den har utvecklats för att du ska kunna använda den i många år, med innovativa funktioner som gör livet enklare – och som inte finns på alla enklare produkter. Ägna några minuter åt denna beskrivning för att få största möjliga utbyte av produkten.

Besök vår webbplats för att:



få tips om användning, broschyrer, felsökning, service- och reparationsinformation:
www.aeg.com/support



registrera din produkt för bättre service:
www.registeraeg.com



köpa tillbehör, förbrukningsvaror och originalreservdelar till din produkt:
www.aeg.com/shop

KUNDTJÄNST OCH SERVICE

Använd alltid originalreservdelar.

Ha följande uppgifter till hands när du kontaktar vår auktoriserade serviceverkstad:

Modell, artikelnummer, serienummer.

Informationen står på märkplåten.

 Varning/Försiktighet – Säkerhetsinformation

 Allmän information och tips

 Miljöinformation

Med reservation för ändringar.

INNEHÅLL

1. SÄKERHETSINFORMATION.....	262
2. SÄKERHETSINSTRUKTIONER.....	263
3. PRODUKTBESKRIVNING.....	266
4. KONTROLLPANELEN.....	267
5. FÖRE FÖRSTA ANVÄNDNING.....	267
6. DAGLIG ANVÄNDNING.....	268
7. KLOCKFUNKTIONER.....	269
8. ANVÄNDNING AV TILLBEHÖR.....	270
9. TILLVALSFUNKTIONER.....	271
10. TIPS.....	271
11. UNDERHÅLL OCH RENGÖRING.....	283
12. FELSÖKNING.....	286
13. ENERGIEFFEKTIVITET.....	287
14. MILJÖSKYDD.....	288

1. ⚠ SÄKERHETSINFORMATION

Läs noga de bifogade instruktionerna före installation och användning av produkten. Tillverkaren är inte ansvarig för eventuella personskador eller andra skador som uppkommit som ett resultat av felaktig installation eller användning. Förvara alltid bruksanvisningen på en säker och tillgänglig plats för framtida bruk.

1.1 Säkerhet för barn och personer med funktionsnedsättning

- Denna produkt kan användas av barn från 8 års ålder och uppåt, och av personer med nedsatt fysisk, sensorisk eller mental förmåga, samt personer med bristande erfarenhet och kunskap om de övervakas eller instrueras om hur produkten används på ett säkert sätt och förstår de risker som är förknippade med användningen. Barn under 8 år eller personer med mycket omfattande och komplexa funktionsnedsättningar ska inte vistas i närheten av produkten utan ständig uppsikt.
- Barn ska hållas under uppsikt så att de inte leker med produkten.
- Håll allt förpackningsmaterial utom räckhåll för barn och kassera det på lämpligt sätt.
- **WARNING!** Ugnen och åtkomliga delar blir mycket varma under användning. Håll barn och husdjur borta från produkten när den används och när den svalnar.
- Om maskinen har ett barnlås ska den aktiveras.
- Barn får inte utföra rengöring och underhåll av produkten utan uppsikt.

1.2 Allmän säkerhet

- Denna produkt är endast avsedd för matlagning.
- Denna produkt är avsedd för enskilt hushållsbruk inomhus.

- Produkten kan användas i kontor, hotellrum, gårdsgästhus och liknande boenden där sådan användning inte innebär att genomsnittlig hushållsförbrukning överskrids.
- Installation av denna produkt och byte av kabeln får endast utföras av behörig person.
- Använd inte produkten innan den har installerats i inbyggnadsstrukturen.
- Bryt strömförsörjningen till apparaten före utförande av underhåll.
- Om nätsladden är skadad måste den bytas av tillverkaren, tillverkarens auktoriserade servicecenter eller personer med motsvarande utbildning, för att undvika fara.
- **WARNING!** Kontrollera att produkten är avstängd innan du byter lampa för att undvika risk för elektriska stötar.
- **WARNING!** Ugnen och åtkomliga delar blir mycket varma under användning. Var försiktig så att du inte vidrör värmeelementen eller ugnsutrymmet.
- Använd alltid ugnsvantar vid iläggning eller urtagning av tillbehör eller ugnsgodis.
- För att ta bort en ugnssteg drar du först ut stegen fram till och sedan den bakre delen från sidoväggen. Sätt tillbaka ugnstegar i omvänd ordning.
- Använd inte ångrengöringsmedel för att rengöra produkten.
- Använd inte skarpa rengöringsmedel med slipeffekt eller vassa metallskrapor för att rengöra luckans glas för att undvika repor, vilka i sin tur kan leda till att glaset spricker.

2. SÄKERHETSINSTRUKTIONER

2.1 Installation

WARNING!

Endast en behörig person får installera den här produkten.

- Avlägsna allt förpackningsmaterial.
- Installera eller använd inte en skadad produkt.
- Följ installationsinstruktionerna som följer med produkten.

- Var alltid försiktig när produkten rör sig eftersom den är tung. Använd alltid skyddshandskar och täckta skor.
- Dra aldrig produkten i handtaget.
- Installera produkten på en säker och lämplig plats som uppfyller installationskraven.
- Minsta avstånd till andra produkter ska beaktas.

- Kontrollera, före installation av ugnen, att ugnsluckan kan öppnas enkelt utan motstånd.
- Produkten är utrustad med ett elektriskt kylsystem. Den måste användas med den elektriska strömförsörjningen.
- En inbyggnadsenhet måste uppfylla stabilitetskraven enligt DIN 68930.

Skåpets minimihöjd (minsta höjd för skåpet under bänk)	578 (600) mm
Skåpets bredd	560 mm
Skåpets djup	550 (550) mm
Höjd på produktens främre del	594 mm
Höjd på produktens bakre del	576 mm
Bredd på produktens främre del	595 mm
Bredd på produktens bakre del	559 mm
Produktens djup	567 mm
Inbyggnadsdjup för produkt	546 mm
Djup med öppen lucka	1027 mm
Minsta storlek på ventilationsöppningen. Öppning placerad nedtill på vänstra sidan	560x20 mm
Nätssladdens längd. Kabeln är placerad i det nedre hörnet på baksidan	1500 mm
Monteringsskruvar	4x25 mm

2.2 Elanslutning

WARNING!

Risk för brand och elektriska stötar.

- Alla elektriska anslutningar ska göras av en behörig elektriker.
- Produkten måste jordas.
- Se till att de parametrarna på märkskylten överensstämmer med elnätets elektricitet.
- Använd alltid ett korrekt installerat, stötsäkert och jordat eluttag.
- Använd inte grenuttag eller förlängningsladdar.

- Kontrollera så att du inte skadar stickkontakten och nätkabeln. Om produktens nätkabel behöver bytas måste det göras av vårt auktoriserade servicecenter.
- Låt inte nätkablar komma i kontakt med eller komma nära produktens lucka eller nichen nedanför produkten, speciellt inte när den är igång eller om luckan är het.
- Stötskyddet för strömförande och isolerade delar måste fästas på ett sådant sätt att det inte kan tas bort utan verktyg.
- Anslut stickkontakten till eluttaget först vid slutet av installationen. Kontrollera att stickkontakten är åtkomlig efter installationen.
- Anslut inte stickkontakten om vägguttaget sitter löst.
- Dra inte i anslutningsladdan för att koppla bort produkten från eluttaget. Ta alltid tag i stickkontakten.
- Använd endast rätt isoleringsenheter: strömbrytare, säkringar (säkringar av skruvtyp tas ur hållaren), jordfelsbrytare och kontaktorer.
- Den elektriska installationen måste ha en isolationsenhet så att du kan koppla från produkten från nätet vid alla poler. Kontaktöppningen på isolationsenheten måste vara minst 3 mm bred.
- Denna produkt levereras med en huvudkontakt och en huvudkabel

2.3 Använd

WARNING!

Risk för skador, brännskador, elstötar eller explosion föreligger.

- Ändra inte produktens specifikationer.
- Kontrollera att ventilationsöppningarna inte är blockerade.
- Låt inte produkten stå utan uppsikt under användning.
- Stäng av produkten efter varje användningstillfälle.
- Var försiktig när du öppnar produktens lucka medan produkten är påslagen. Varm luft kan strömma ut.
- Använd inte produkten med våta händer eller när den har kontakt med vatten.
- Tryck inte på den öppna luckan.

- Använd inte produkten som arbets- eller avlastningsyta.
- Öppna luckan försiktigt. Användning av ingredienser med alkohol kan orsaka blandning av alkohol och luft.
- Låt inte gnistor eller öppna lågor komma i kontakt med produkten när du öppnar luckan.
- Placera inte brandfarliga produkter eller föremål som är våta med brandfarliga produkter i, i närheten av eller på produkten.

⚠ VARNING!

Risk för skador på produkten föreligger.

- För att förhindra skador eller missfärgning på emaljen:
 - placera inte eldfasta former eller andra föremål direkt på ugnsbotten.
 - lägg inte aluminiumfolie direkt på ugnsbotten.
 - håll inte vatten direkt i den heta produkten.
 - Låt inte fuktiga maträtter eller matvaror stå kvar i produkten när tillagningen är klar.
 - var försiktig när du tar bort eller installerar tillbehören.
- Missfärgning av emaljen eller den rostfria ytan påverkar inte produktens funktion.
- Använd en djup form för mjuka kakor.
- Fruk juice kan orsaka fläckar som inte går att ta bort.
- Laga alltid mat med luckan stängd.
- Om produkten installeras bakom en beklädnadspanel, till exempel i ett skåp, se till att skåpsdörren eller panelen aldrig är stängd när produkten används. Värme och fukt kan byggas upp bakom en stängd lucka och orsaka skador på produkten, skåpsmöblerna eller golvet. Stäng inte luckan förrän produkten har svalnat helt efter användning.

2.4 Underhåll och rengöring

⚠ VARNING!

Det finns risk för personskador, brand eller skador på produkten.

- Stäng av produkten och koppla bort den från eluttaget före underhåll.

- Se till att produkten har svalnat. Det finns även risk för att glaspanelerna kan spricka.
- Byt omedelbart ut luckans glaspaneler om de är skadade. Kontakta auktoriserat servicecenter.
- Var försiktig när du tar bort luckan. Luckan är tung!
- Rengör produkten regelbundet för att förhindra att ytmaterialet försämras.
- Rengör produkten med en fuktig, mjuk trasa. Använd bara milda rengöringsmedel. Använd inte produkter med slip-effekt, skursvampar, lösningsmedel eller metallföremål.
- Om du använder en ugnssprej ska du följa säkerhetsanvisningarna på förpackningen.

2.5 Invändig belysning

⚠ VARNING!

Risk för elektrisk stöt!

- När det gäller lampan/lamporna i denna produkt och reservlampor som säljs separat: Dessa lampor är avsedda att tåla extrema fysiska förhållanden i hushållsapparater, såsom temperatur, vibration, fuktighet eller är avsedda att signalera information om produktens driftsstatus. De är inte avsedda att användas i andra produkter eller som rumsbelysning i hemmet.
- Denna produkt innehåller en ljuskälla med energieffektivitetsklass G.
- Använd bara lampor med samma specifikationer.

2.6 Service

- Kontakta ett auktoriserat servicecenter för reparation av produkten.
- Använd endast originalreservdelar.

2.7 Avyttring

⚠ VARNING!

Risk för kvävning eller skador.

- Kontakta kommunen för information om hur produkten ska kasseras.
- Koppla loss produkten från eluttaget.

- Klipp av elkabeln nära produkten och kassera den.

- Ta bort luckspärren för att förhindra att barn eller husdjur blir instängda i maskinen.

3. PRODUKTBESKRIVNING

3.1 Allmän översikt

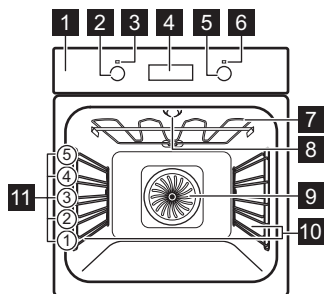

- 1** Kontrollpanel
- 2** Funktionsratt för tillagningsfunktioner
- 3** Strömlampa/symbol
- 4** Display
- 5** Temperaturinställningsratt
- 6** Temperaturindikator/symbol
- 7** Värmeelement
- 8** Lampa
- 9** Fläkt
- 10** Ugnsstegar, borttagbara
- 11** Hyllplaceringar

3.2 Tillbehör

Galler

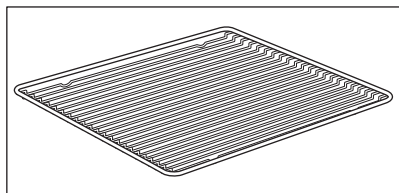

För kokkärl, kakformar, stekar.

Bakplåt

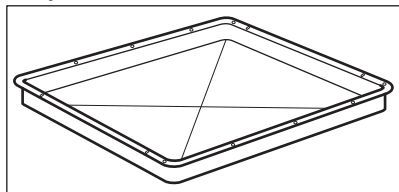

För kakor och småkakor.

Grill- / stekpanna

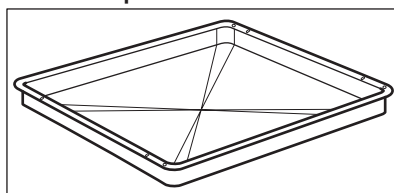

För bakning och stekning eller som fettuppsamlingsfat.

4. KONTROLLPANELEN

4.1 Infällbara vred

För att använda produkten, tryck på kontrollvredet. Vredet kommer ut.

4.2 Sensorfält/knappar

—	Gör så här för att ställa in tiden.
	Ställa in en klockfunktion.
+	Gör så här för att ställa in tiden.

4.3 Display

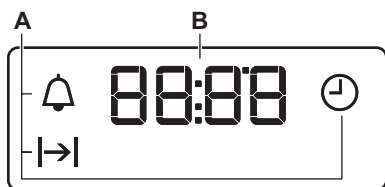

- A. Klockfunktioner
- B. Timer







5. FÖRE FÖRSTA ANVÄNDNING

⚠ VARNING!

Se Säkerhetsavsnitten.

5.1 Före första användning

Ugnen kan avge lukt och rök under uppvärmning. Se till att rummet är ventilerat.

 Steg 1	 Steg 2	 Steg 3
Ställa tiden	Rengöra ugnen	Förvärm den tomma ugnen
1.  ,  – tryck för att ställa tiden. Efter cirka 5 sekunder slutar blinkningarna och tiden visas på displayen.	1. Ta ut alla tillbehör och flyttbara ugnsstegar ur ugnen. 2. Rengör ugnen och dess tillbehör med enbart en mikrofiberduk, varmt vatten och ett mildt rengöringsmedel.	1. Ställ in maxtemperatur för funktionen:  . Tid: 1 tim. 2. Ställ in maxtemperatur för funktionen:  . Tid: 15 min.

Stäng av ugnen och vänta tills den har svalnat. Sätt in tillbehören och de löstagbara ugnstegarna i ugnen.

6. DAGLIG ANVÄNDNING







VARNING!





Se Säkerhetsavsnitten.

6.1 Hur man ställer in: Värmefunktion

- Steg 1** Vrid på vredet för värmefunktioner för att välja en värmefunktion.
- Steg 2** Vrid på kontrollvredet för att välja temperatur.
- Steg 3** När matlagningen är klar, vrid på vreden till avstängt läge för att stänga av ugnen.

6.2 Tillagningsfunktioner

Tillagningsfunktion	Användning
 Av-läge	Ugnen är avstängd.
 Belysning	För att tända ugnsbelysningen.
 Varmluft	För tillagning eller torkning på upp till tre ugnsnivåer samtidigt. Ställ in temperaturen på 20–40 °C lägre än för Över-/undervärme.
 Pizza/Paj	För att tillaga pizza. För att bryna ordentligt och få en knaprig botten.
 Över-/undervärme	Tillagning och stekning på en ugnsnivå.
 Undervärme	För bakning av kakor med knaprig botten och för konservering av livsmedel.

Tillagningsfunktion	Användning
 Upptining	För att tina mat (grönsaker och frukt). Upptiningstiden beror på mängden och storleken på den frysta maten.
 Varmluft med fukt	Denna funktion är för att spara energi under tillagningen. När du använder den här funktionen kan temperaturen i ugnen skilja sig från inställd temperatur. Restvärmen används. Värmeeffekten kan minskas. Mer information finns i kapitlet "Daglig användning" och anvisningar om: Varmluft med fukt.
 Grill	För grillning av tunnskurna stycken och brödrostning.
 Varmluftsgrillning	Varmluftstekning på första ugnsnivån av större köttstycken eller fågelkött med ben. För att bryna och göra gratänger.



Lampan kan släckas automatiskt vid en temperatur under 60 °C med vissa ugnsfunktioner.

6.3 Anmärkningar om: Varmluft med fukt



Denna funktion användes för att uppfylla kraven för energieffektivitet och ekodesigns (enligt EU 65/2014 och EU 66/2014). Tester enligt: IEC/EN 60350-1.

Ugnsluckan ska vara stängd under tillagningen så att funktionen inte avbryts och ugnen fungerar med högsta möjliga energieffektivitet.

För tillagningsinstruktioner, se kapitlet "Råd och tips" Varmluft med fukt För instruktioner om allmän energibesparing, se kapitlet "Energieffektivitet", energibesparing.

7. KLOCKFUNKTIONER

7.1 Klockfunktioner

Klockfunktion	Program
 Klockslag	För att ställa in, ändra eller kontrollera tiden.
 Koktid	För att ställa in hur länge ugnen ska vara påslagen.
 Tidur	För att ställa in en tid som räknas ned. Denna funktion påverkar inte ugnens funktioner i övrigt. Du kan ställa in den här funktionen när som helst, även när ugnen är avstängd.

7.2 Så här ställer du in: Klockfunktioner

Så här ställer du in: Klockslag



 – blinkar när du ansluter ugnen till eluttaget, när det har varit ett strömavbrott eller när timern inte är inställd.

 ,  – tryck för att ställa in tiden.

Efter cirka 5 sekunder slutar blinkningarna och tiden visas på displayen.

Så här ändrar du:Klockslag





Steg 1  – tryck upprepade gånger för att ändra klockslaget.  – börjar blinka.

Steg 2  ,  – tryck för att ställa in tiden.
Efter cirka 5 sekunder slutar blinkningarna och tiden visas på displayen.

Så här ställer du in: Koktid

Steg 1 Välj funktion och ugnstemperatur.

Steg 2  – tryck upprepade gånger.  – börjar blinka.

Steg 3  ,  – tryck för att ställa in tillagningstiden.
På displayen visas: 
 – blinkar när den inställda tiden har gått. Signalen ljuder och ugnen stängs av.

Steg 4 Tryck på valfri knapp för att stänga av ljudsignalen.

Steg 5 Vrid inställningsvreden till avstängt läge.

Så här ställer du in: Tidur

Steg 1  – tryck upprepade gånger.  – börjar blinka.

Så här ställer du in: Tidur

- Steg 2** **+**, **-** – tryck för att ställa in tiden.
Funktionen startar automatiskt efter 5 sekunder.
När den inställda tiden har gått hörs en ljudsignal.
- Steg 3** Tryck på valfri knapp för att stänga av ljudsignalen.
- Steg 4** Vrid inställningsratten till avstängt läge.

Så här avbryter du:Klockfunktioner

- Steg 1**  – tryck upprepade gånger tills symbolen för klockfunktionen börjar blinka.
- Steg 2** Tryck och håll in: **—**.
Klockfunktionen stängs av efter några sekunder.

8. ANVÄNDNING AV TILLBEHÖR

VARNING!

Se Säkerhetsavsnitten.

8.1 Sätta in tillbehör

Liten inbuktning upptill ökar säkerheten.
Fördjupningarna är för också enheterna

tippsäkra. Den höga kanten runt hyllan
hindrar att kokkärl glider av.

Galler:

Skjut in galleret mellan ugnstegens ledskenor.

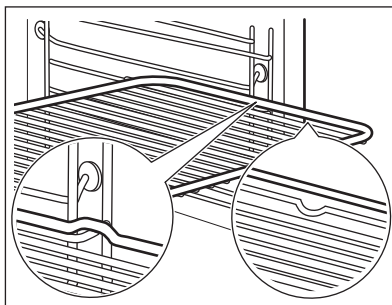

Bakplåt / Djup form:

Skjut in långpannan mellan ungsstegarnas ledskenor.

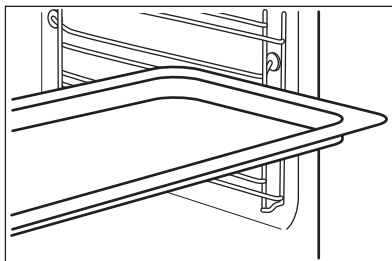

9. TILLVALSFUNKTIONER

9.1 Kylfläkt

När ugnen är på, slås fläkten på automatiskt för att hålla ugnens ytor svala. Om du stänger

av ugnen fortsätter fläkten att gå tills ugnen svalnat.

10. TIPS



Se Säkerhetsavsnitten.

10.1 Tillagningsrekommendationer



Temperatur och tillagningstid i tabellerna är endast riktvärden. Hur de ska väljas beror på recept och ingrediensernas kvalitet och mängd.

Ugnen kan baka eller steka annorlunda än din gamla ugn. Tabellerna nedan visar rekommenderade inställningar för temperatur, tillagningstid och hyllposition för specifika typer av mat.

Om du inte kan hitta inställningarna för ett visst recept kanske du kan använda inställningarna för ett liknande recept.

10.2 Gräddning

För första gräddningen, använd den lägre temperaturen.

Du kan förlänga gräddningstiden med 10–15 minuter om du bakar på mer än en nivå.

Bakverk vid olika nivåer blir inte alltid lika bruna. Du behöver inte ändra





ugnstemperaturen om de blir olika bruna. Detta jämnar ut sig under bakningen.

Plåtarna i ugnen kan vrida sig under bakning. När plåtarna kallnar igen återtar de sin normala form.

10.3 Tips för bakning

Bakresultat	Möjlig orsak	Lösning
Kakans botten är inte tillräckligt gräddad.	Ugnsnivån är fel.	Ställ kakan på en lägre ugnsnivå.
Kakan faller ihop och blir degig eller får vattenränder.	Ugnstemperaturen är för hög.	Ställ in något lägre ugnstemperatur nästa gång.
	Ugnstemperaturen är för hög och gräddningstiden är för kort.	Ställ in längre gräddningstid och lägre ugnstemperatur nästa gång.
Kakan är för torr.	Ugnstemperaturen är för låg.	Ställ in högre ugnstemperatur nästa gång.
	För lång gräddningstid.	Ställ in kortare gräddningstid nästa gång.
Kakan blir ojämn.	Ugnstemperaturen är för hög och gräddningstiden är för kort.	Ställ in längre gräddningstid och lägre ugnstemperatur nästa gång.
	Kaksmeten har inte fördelats jämnt.	Fördela smeten jämnare på bakplåten nästa gång.
Kakan blir inte klar på tiden som anges i receptet.	Ugnstemperaturen är för låg.	Ställ in något högre ugnstemperatur nästa gång.



10.4 Baka på en hyllnivå



 BAKA I FORMAR		 (°C)	 (min.)	
Tårtbotten, förvärm den tomma ugnen	Varmluft	170 - 180	10 - 25	2
Tårtbotten av sockerkakssmet	Varmluft	150 - 170	20 - 25	2
Sockerkaka / Brioche	Varmluft	150 - 160	50 - 70	1
Madeirakaka / Fruktkaka	Varmluft	140 - 160	70 - 90	1
Cheesecake	Över-/undervärme	170 - 190	60 - 90	1

Använd den tredje hyllpositionen.

Använd funktionen: Varmluft.

Använd en bakplåt.





 KAKOR/BAKVERK/BRÖD	 (°C)	 (min.)
Kaka med smördegstopping	150 - 160	20 - 40

 KAKOR/BAKVERK/BRÖD	 (°C)	 (min.)
Fruktpaj (på jästdeg/sockerkakssmet), använd en långpanna	150	35 - 55
Fruktpaj av mördeg	160 - 170	40 - 80





Förvärm den tomma ugnen.





Använd funktionen: Över-/undervärme.

Använd en bakplåt.

 KAKOR/BAKVERK/BRÖD	 (°C)	 (min.)	
Rulltårta	180 - 200	10 - 20	3
Rågbröd:	först: 230	20	1
	sedan: 160 - 180	30 - 60	
Mandelsockerkaka / Småkakor	190 - 210	20 - 30	3
Petits-choux med fyllning / Bakelser	190 - 210	20 - 35	3
Veteflåta / Runt bröd	170 - 190	30 - 40	3
Fruktpaj (på jästdeg/sockerkakssmet), använd en långpanna	170	35 - 55	3
Jästkaka med läcker fyllning (t.ex. kvarg, grädde, kräm)	160 - 180	40 - 80	3
Christollen	160 - 180	50 - 70	2





Använd den tredje hyllpositionen.

 SLÄTA BULLAR		 (°C)	 (min.)
Mördegskex	Varmluft	150 - 160	10 - 20
Frallor, förvärm den tomma ugnen	Varmluft	160	10 - 25
Småkakor av sockerkakssmet	Varmluft	150 - 160	15 - 20
Smördegskakor, förvärm den tomma ugnen	Varmluft	170 - 180	20 - 30
Småkakor av jästdeg	Varmluft	150 - 160	20 - 40

 SLÄTA BULLAR 	 (°C)	 (min.)	
Mandelbiskvier	Varmluft	100 - 120	30 - 50
Bakverk med äggvita / Marängar	Varmluft	80 - 100	120 - 150
Frallor, förvärm den tomma ugnen	Över-/undervärme	190 - 210	10 - 25

10.5 Puddingar och gratänger





Använd den första hyllpositionen.





 	 (°C)	 (min.)	
Baguette garnerad med smält ost	Varmluft	160 - 170	15 - 30
Grönsaksgratäng, förvärm den tomma ugnen	Varmluftsgrillning	160 - 170	15 - 30
Lasagne	Över-/undervärme	180 - 200	25 - 40
Fiskpudding	Över-/undervärme	180 - 200	30 - 60
Fyllda grönsaker	Varmluft	160 - 170	30 - 60
Söta bakverk	Över-/undervärme	180 - 200	40 - 60
Makaronpudding	Över-/undervärme	180 - 200	45 - 60

10.6 Baka på flera nivåer

Använd funktionen: Varmluft.

Använd bakplåtarna.

 KAKOR/ BAKVERK 	 (min.)		
Petits-choux med fyllning / Bakelser, förvärm den tomma ugnen	160 - 180	25 - 45	2 positioner 1 / 4
Torr strösselkaka	150 - 160	30 - 45	1 / 4

 KA-KOR/SMÅKAKOR/BAKVERK/BULLAR	 (°C)	 (min.)		
			2 positioner	3 positioner
Frallor	180	20 - 30	1 / 4	-
Mördegskex	150 - 160	20 - 40	1 / 4	1 / 3 / 5
Småkakor av sockerkakssmet	160 - 170	25 - 40	1 / 4	-
Smördegskakor, förvärm den tomma ugnen	170 - 180	30 - 50	1 / 4	-
Småkakor av jästdeg	160 - 170	30 - 60	1 / 4	-
Mandelbiskvier	100 - 120	40 - 80	1 / 4	-
Maränger / Maränger	80 - 100	130 - 170	1 / 4	-

10.7 Tips gällande ugnstekning

Använd värmebeständiga ugnsgformar.

Stek magert kött övertäckt (t.ex. aluminiumfolie).

Stek stora bitar av kött direkt på plåten.

Häll lite vatten på plåten för att förhindra att droppande fett bränner fast.

Vänd steken efter 1/2 - 2/3 av stektiden.







Stek kött och fisk i stora bitar (1 kg eller mer).

Om nedersta nivån föreslås, lägger du maten direkt på bakplåten

Ös köttet med sin egen köttsaft flera gånger under stekning.

10.8 Stekning

Använd den första hyllpositionen.

 NÖTKÖTT				 (°C)	 (min.)
Grytstek	1 - 1,5 kg	Över-/undervärme	230	120 - 150	
Rostbiff eller filé, blodig, förvärm den tomma ugnen	per cm tjocklek	Varmluftsgrillning	190 - 200	5 - 6	
Rostbiff eller filé, medium, förvärm den tomma ugnen	per cm tjocklek	Varmluftsgrillning	180 - 190	6 - 8	
Rostbiff eller filé, välstekt, förvärm den tomma ugnen	per cm tjocklek	Varmluftsgrillning	170 - 180	8 - 10	



FLÄSK



Använd funktionen: Varmluftsgrillning.



(kg)



(°C)



(min.)

Bog / Hals / Skinkstek

1 - 1.5

160 - 180

90 - 120

Kotletter / Revbensspjäll

1 - 1.5

170 - 180

60 - 90

Köttfärslimpa

0.75 - 1

160 - 170

50 - 60

Fläsklägg, förkokt

0.75 - 1

150 - 170

90 - 120



KALV



Använd funktionen: Varmluftsgrillning.



(kg)



(°C)



(min.)

Ugnsstek kalvkött

1

160 - 180

90 - 120

Kalvlägg

1.5 - 2

160 - 180

120 - 150



LAMM



Använd funktionen: Varmluftsgrillning.



(kg)



(°C)



(min.)

Lammlägg / Lammstek

1 - 1.5

150 - 170

100 - 120

Lamm, sadel

1 - 1.5

160 - 180

40 - 60



VILT



Använd funktionen: Över-/undervärme.



(kg)



(°C)



(min.)

Sadel / Harlägg, förvärm den tomma ugnen

upp till 1

230

30 - 40

Rådjur, sadel

1.5 - 2

210 - 220

35 - 40

Rådjursbog

1.5 - 2

180 - 200

60 - 90



FÅGEL



Använd funktionen: Varmluftsgillning.



(kg)



(°C)



(min.)

Bitar av fågel

0,2 - 0,25 var

200 - 220

30 - 50

Halv kyckling

0,4 - 0,5 var

190 - 210

35 - 50

Kycklingbitar

1 - 1.5

190 - 210

50 - 70

Anka

1.5 - 2

180 - 200

80 - 100

Gås

3.5 - 5

160 - 180

120 - 180

Kalkon

2.5 - 3.5

160 - 180

120 - 150

Kalkon

4 - 6

140 - 160

150 - 240



FISK (ÅNGKOKT)



Använd funktionen: Över-/undervärme.



(kg)



(°C)



(min.)





Hel fisk







1 - 1.5







210 - 220

40 - 60

10.9 Knaprig tillagning med inställningen: Pizza/Paj

 PIZZA		
 Använd den första hyllpositionen.		
	 (°C)	 (min.)
Pajer	180 - 200	40 - 55
Spensatpaj	160 - 180	45 - 60
Quiche lorraine / Schweizisk bakelse	170 - 190	45 - 55
Cheesecake	140 - 160	60 - 90
Grönsakspaj	160 - 180	50 - 60

 PIZZA		
 Fövärm den tomma ugnen före tillagning.		
 Använd den andra hyllpositionen.		
	 (°C)	 (min.)
Pizza med tunn botten, använd en långpanna	200 - 230	15 - 20

 PIZZA		
 Fövärm den tomma ugnen före tillagning.		
 Använd den andra hyllpositionen.		
	 (°C)	 (min.)
Tjockbottnad pizza	180 - 200	20 - 30
Osyrat Bröd	230 - 250	10 - 20
Smördegspaj	160 - 180	45 - 55
Flammkuchen	230 - 250	12 - 20
Piroger	180 - 200	15 - 25

10.10 Grill

Fövärm den tomma ugnen före tillagning.

Grilla endast tunna bitar av kött eller fisk.

Placera en form på första hyllpositionen för att samla upp fett.



GRILL



Använd funktionen: Grill



(°C)



(min.)

1:a sidan



(min.)

2:a sidan



	(°C)	(min.) 1:a sidan	(min.) 2:a sidan	
Rostbiff	210 - 230	30 - 40	30 - 40	2
Oxfilé	230	20 - 30	20 - 30	3
Fläskkarré	210 - 230	30 - 40	30 - 40	2
Kalvfransyska	210 - 230	30 - 40	30 - 40	2
Lamm, sadel	210 - 230	25 - 35	20 - 25	3
Hel fisk, 0,5 kg - 1 kg	210 - 230	15 - 30	15 - 30	3 / 4

10.11 Fryst mat



AVFROSTNING



Använd funktionen: Varmluft.



(°C)



(min.)



	(°C)	(min.)	
Fryst pizza	200 - 220	15 - 25	2
Fryst panpizza	190 - 210	20 - 25	2
Kyld pizza	210 - 230	13 - 25	2
Fryst portionspizza	180 - 200	15 - 30	2
Pommes frites, tunna	200 - 220	20 - 30	3
Pommes frites, tjocka	200 - 220	25 - 35	3
Klyftor / Kroketter	220 - 230	20 - 35	3
Rösti	210 - 230	20 - 30	3
Lasagne / Cannelloni, färsk	170 - 190	35 - 45	2
Lasagne / Cannelloni, fryst	160 - 180	40 - 60	2
Ugnsbakad ost	170 - 190	20 - 30	3
Kycklingvingar	190 - 210	20 - 30	2





10.12 Upptining

Ta bort förpackningen från maten och lägg den sedan på en tallrik.

Täck inte över maten eftersom det kan förlänga avfrostningstiden.

Använd den första hyllpositionen.

Om du lagar större portioner ska en tom tallrik placeras upp och ner på botten av ugnen. Lägg maten i en djup form och ställ den ovanpå tillriken inne i ugnen. Ta bort hyllstöden om det behövs.

	 (kg)	 (min.) Upptiningstid	 (min.) Mer avfrostnings- tid	
Kyckling	1	100 - 140	20 - 30	Vänd efter halva tiden.
Kött	1	100 - 140	20 - 30	Vänd efter halva tiden.
Öring	0.15	25 - 35	10 - 15	-
Jordgubbar	0.3	30 - 40	10 - 20	-
Smör	0.25	30 - 40	10 - 15	-
Grädde	2 x 0,2	80 - 100	10 - 15	Vispa grädden medan den fortfarande är något fryst.
Gateau	1.4	60	60	-

10.13 Konservering

Använd funktionen Undervärme.

Använd enbart konserveringsburkar av samma mått som finns att köpa.

Använd inte glas med skruvlock och bajonettförslutning eller metallburkar.

Använd den första hyllpositionen.

Sätt inte mer än sex enliters burkar på plåten.





Fyll upp burkarna med lika mycket i varje och förslut med ett klämlock.



Burkarna får inte röra vid varandra.

Häll ca. 1/2 liter vatten i bakplåten så att det blir tillräckligt fuktigt i ugnen.

När vätskan i burkarna börjar sjuda (efter ca 35 - 60 minuter med enlitersburkarna) stänger du av ugnen eller sänker temperaturen till 100 °C (se tabellen).

Ställ in temperaturen till 160 - 170 °C.

 MJUK FRUKT	 (min.) Tillagningstid tills det börjar sjuda	
Jordgubbar / Blåbär / Hal- lon / Mogna krusbär	35 - 45	
 STEN- FRUKT	 (min.) Tillagnings- tid tills det börjar sjuda	 (min.) Fortsätt tilla- ga på 100 °C
Persikor / Kvit- ten / Plommon	35 - 45	10 - 15

 GRÖNSAKER	 (min.) Tillagnings- tid tills det börjar sjuda	 (min.) Fortsätt tilla- ga på 100 °C
Morötter	50 - 60	5 - 10
Gurka	50 - 60	-
Blandade inlagda grönsaker	50 - 60	5 - 10
Kålramb / Ärtor / Sparris	50 - 60	15 - 20

10.14 Torkning - Varmluft

Täck plåten med smörpapper eller bakplåtspapper.

För bästa resultat, stäng av ugnen efter halva torktiden, öppna luckan och låt den svalna och torka över natten.

För en plåt, använd den tredje hyllpositionen.

För två plåtar, använd den första och den fjärde hyllpositionen.

10.15 Varmluft med fukt - rekommenderade tillbehör

Använd mörka och icke reflekterande burkar och formar. De absorberar värme bättre än ljusa färger och reflektiva formar.



Pizzaform

Mörk, icke reflekterande
28 cm diameter

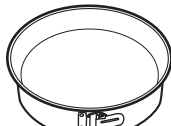

Ugnsform

Mörk, icke reflekterande
26 cm diameter



Portionsformar

Keramik
8 cm diameter, 5
cm hög





Tärtbottenform



Mörk, icke reflekterande
28 cm diameter





10.16 Varmluft med fukt

För bästa resultat ska du följa förslagen som listas i tabellen nedan.

 GRÖNSA- KER	 (°C)	 (tim)
Bönor	60–70	6–8
Paprika	60–70	5–6
Soppgrönsaker	60–70	5–6
Svamp	50–60	6–8
Örter	40–50	2–3

Ställ in temperaturen på 60–70 °C.





 FRUKT	 (tim)
Plommon	8–10
Aprikoser	8–10
Äppelskivor	6–8
Päron	6–9

	 (°C)	 (min.)	
Grissini, 0,5 kg totalt	190 - 200	50 - 60	3
Kammusslor i skal	180 - 200	30 - 40	4
Hel fisk i salt, 0,3 - 0,5 kg	190 - 200	45 - 50	4
Hel fisk i bakplåtspapper, 0,3 - 0,5 kg	190 - 200	50 - 60	3
Amaretti (20; 0,5 kg totalt)	170 - 180	40 - 50	3
Smulpaj med äpple	190 - 200	50 - 60	4
Chokladmuffins (20; 0,5 kg totalt)	160 - 170	35 - 45	3

10.17 Information för testinstitut





Tester enligt: EN 60350, IEC 60350.

Bakning på en nivå – bakning i formar





		 °C	 min	
Sockerkaka utan fett	Varmluft	160	45 - 60	2
Sockerkaka utan fett	Över-/undervärme	160	45 - 60	2
Äppelpaj, 2 st 20 cm formar	Varmluft	160	55 - 65	2
Äppelpaj, 2 st 20 cm formar	Över-/undervärme	180	55 - 65	1
Mördegskakor	Varmluft	140	25 - 35	2
Mördegskakor	Över-/undervärme	140	25 - 35	2

Bakning på en nivå – kakor

Använd den tredje hyllpositionen.

		 °C	 min
Småkakor, 20 st/plåt, förvärm den tomma ugnen	Varmluft	150	20 - 30
Småkakor, 20 st/plåt, förvärm den tomma ugnen	Över-/undervärme	170	20 - 30





Bakning på flera nivåer – kakor

		 °C	 min	
Mördegskakor	Varmluft	140	25 - 45	2 / 4
Småkakor, 20 st/plåt, förvärm den tomma ugnen	Varmluft	150	25 - 35	1 / 4
Sockerkaka utan fett	Varmluft	160	45 - 55	2 / 4
Äppelpaj, 1 burk per galler (Ø 20 cm)	Varmluft	160	55 - 65	2 / 4

GRILL

Förvärm den tomma ugnen i 5 minuter.

Grillning med maximal temperaturinställning.

		 min	
Rostat bröd	Grill	1 - 2	5
Nötkstek, vänd efter halva tiden	Grill	24 - 30	4

11. UNDERHÅLL OCH RENGÖRING

VARNING!

Se Säkerhetsavsnitten.

11.1 Rengöring



**Rengöringsme-
del**

Rengör ugnens framsida med en mikrofiberduk med varmt vatten och ett mildt rengöringsme-
del.

Använd en rengöringslösning för att rengöra metalldelar.

Rengör fläckar med ett mildt diskmedel.



**För användning
varje dag**

Rengör ugnsutrymmet efter varje användningstillfälle. Fettansamling eller andra matrester
kan leda till brand.

Låt inte maten stå i ugnen längre än 20 minuter. Torka ugnsutrymmet med enbart en mikrofi-
berduk efter varje användning.



Tillbehör

Rengör alla tillbehör efter varje användningstillfälle och låt dem torka. Använd enbart en mikrofibreduk med varmt vatten och ett mildt rengöringsmedel. Diska inte tillbehören i diskmaskin.

Använd inte rengöringsmedel med slipeffekt eller vassa föremål när du rengör SuperClean-tillbehören.

11.2 Hur man tar bort: Ugnsstegar

Ta bort ugnsstegarna vid rengöring av ugnen.

Steg 1 Stäng av ugnen och vänta tills den har svalnat.

Steg 2 Dra först ut stegarnas främre del från sidoväggen.

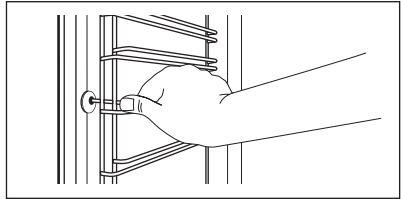

Steg 3 Dra den bakre änden av ugnsstegen bort från sidoväggen och ta bort den.

Steg 4 Sätt tillbaka ugnsstegar i omvänd ordning.

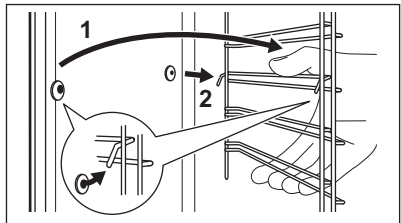

11.3 Hur man tar bort: Grill

⚠ VARNING!

Det finns risk för att du bränner dig.

Steg 1 Stäng av ugnen och vänta med att rengöra den tills den har svalnat. Ta ut ugnsstegarna.

Steg 2 Ta tag i grillens hörn. Dra den framåt mot fjädertrycket och ut ur de två hållarna. Grillen fälls ner.

Steg 3 Rengör ugnens tak med varmt vatten, en mjuk trasa och ett mildt rengöringsmedel. Låt det torka.

Steg 4 Sätt tillbaka grillen i omvänd ordning.

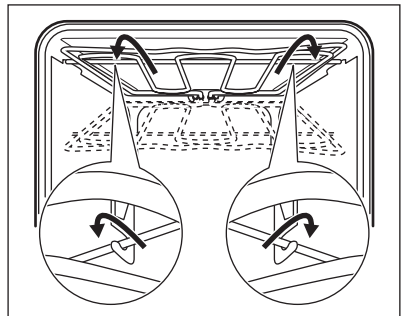

Steg 5 Sätt i ugnsstegarna.

11.4 Hur man tar bort och installerar: Luckan

Man kan ta loss och rengöra luckan och de inre glasrutorna. Antalet glaspaneler skiljer sig åt för olika modeller.

VARNING!

Luckan är tung.

FÖRSIKTIGHET!

Hantera glaset varsamt, särskilt runt den främre panelens kanter. Glaset kan gå sönder.

- Steg 1** Öppna luckan helt.
- Steg 2** Lyft och tryck in klämspjärrarna (A) på de två gängjärnen till luckan.

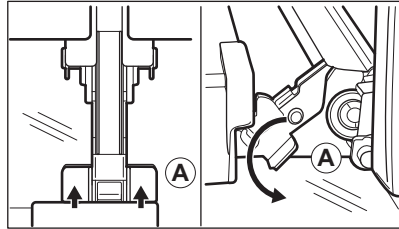

- Steg 3** Stäng ugnsluckan till den första öppna positionen (ungefär 70° vinkel). Håll i luckan på båda sidorna och dra den ut från ugnen i en uppåtgående vinkel. Lägg ner luckan med utsidan neråt på en mjuk handduk på ett stabilt underlag.

- Steg 4** Ta tag i lucklisten (B) på båda sidorna av luckans övre kant och tryck inåt för att frigöra klämlåset.

- Steg 5** Dra lucklisten framåt för att ta bort den.

- Steg 6** Håll glaset i överkanten ett i taget och dra dem uppåt och ut ur skenan.

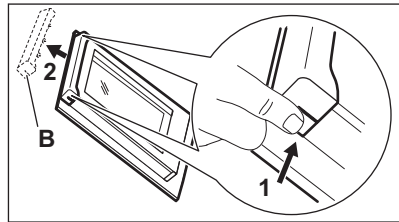

- Steg 7** Rengör glaset med vatten och tvål. Torka luckglaset nogga. Diska inte glasskivorna i diskmaskin.

- Steg 8** Efter rengöring, utför stegen ovan i omvänd ordning.

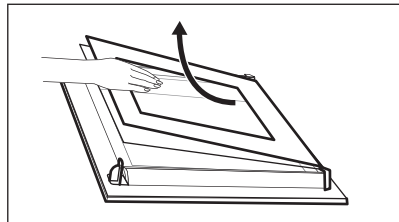

- Steg 9** Sätt i det mindre ugnsglaset först, därefter det större och sist luckan. Se till att glaset är korrekt och ordentligt införda, annars kan luckans yta bli överhettad.

11.5 Byte av: Lampa

VARNING!

Risk för elektrisk stöt!
Lampan kan vara het.

Innan du byter lampan:

Steg 1	Steg 2	Steg 3
Stäng av ugnen. Vänta tills ugnen är kall.	Koppla bort ugnen från eluttaget.	Lägg en trasa i botten av ugnsutrymmet.

Övre lampa

Steg 1 Ta bort glasskyddet genom att vrida på det.

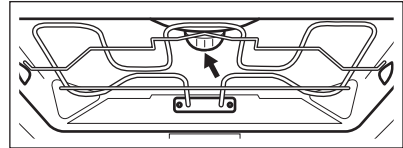

Steg 2 Rengör glasskyddet.

Steg 3 Byt ut lampan mot en passande som tål upp till 300 °C.

Steg 4 Sätt tillbaka glasskyddet.

12. FELSÖKNING

VARNING!

Se Säkerhetsavsnitten.

12.1 Vad gör jag om ...

Om något saknas i denna tabell, kontakta ett auktoriserat servicecenter.

Problem	Kontrollera att...
Ugnen värms inte upp.	Säkringarna har gått.
Displayen visar "12:00".	Ett strömavbrott har inträffat. Ställ in klockan.
Belysningen fungerar inte.	Glödlampan är trasig.

12.2 Servicedata

Kontakta din återförsäljare eller en auktoriserad serviceverkstad om du inte kan avhjälpa felet.

Nödvändig information som servicecentret behöver finns på graderingsskylten. Typskylten sitter på ugnsutrymmets främre ram. Avlägsna inte typskylten från ugnsutrymmet.

Vi rekommenderar att du antecknar uppgifterna här:

Modell (MOD.)

Produktnummer (PNC)

Serienummer (S.N.)

13. ENERGIEFFEKTIVITET

13.1 Produktinformation och produktinformationsblad enligt EU:s ekodesign- och energimärkningsförordningar

Leverantörens namn	AEG	
Modellidentifiering	BEK435060B 944188455 EB40B 944188534	
Energieffektivitetsindex	81.2	
Energieffektivitetsklass	A+	
Energiförbrukning med standardbelastning, konventionellt läge	0.99kWh/cykel	
Energiförbrukning med standardbelastning, varmlufts läge	0.69kWh/cykel	
Antal kaviteter	1	
Värmekälla	Elektricitet	
Volym	71l	
Typ av ugn	Inbyggd ugn	
Massa	BEK435060B	33.0kg
	EB40B	33.0kg

IEC/EN 60350-1 - Elektriska hushållsapparater för matlagning - Del 1: Sortiment, ugnar, ångugnar och grillar - metoder för att mäta prestanda.

13.2 Energibesparing



Denna produkt har funktioner som låter dig spara energi under vanlig matlagning.

Kontrollera att ugnsluckan är ordentligt stängd när ugnen är påslagen. Öppna inte ugnsluckan för ofta under tillagningen. Håll luckans tätningstätt är ren och kontrollera att den sitter rätt och ordentligt fast.

Använd kokkärl i metall för högre energieffektivitet.

Om möjligt, undvik att förvärma ugnen före tillagning.

Gör så korta uppehåll som möjligt vid tillagning av flera rätter för samma tillfälle.

Tillagning med varmluft

Om möjligt, använd varmluftsfunktionen för att spara energi.

Restvärme

Om tillagningen tar längre tid än 30 minuter, sänk ugnstemperaturen med minst 3–10 minuter innan tillagningen avslutas. Tillagningen fortsätter med ugnens restvärme.

Använd restvärmen för att värma annan mat.

Varmhållning

Välj lägsta möjliga temperaturinställning för att använda restvärme och hålla maten varm.

Varmluft med fukt

Denna funktion används för att spara energi under tillagningen.

14. MILJÖSKYDD

Återvinn material med symbolen . Återvinn förpackningen genom att placera den i lämpligt kärl. Bidra till att skydda vår miljö och vår hälsa genom att återvinna avfall från elektriska och elektroniska produkter. Släng

inte produkter märkta med symbolen  med hushållsavfallet. Lämna in produkten på närmaste återvinningsstation eller kontakta kommunkontoret.







aeg.com

867361901-G-112023



CE