

DOMINIK

05860107/01
05860107/02

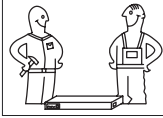

2 Pers.

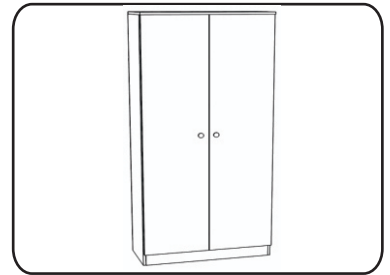
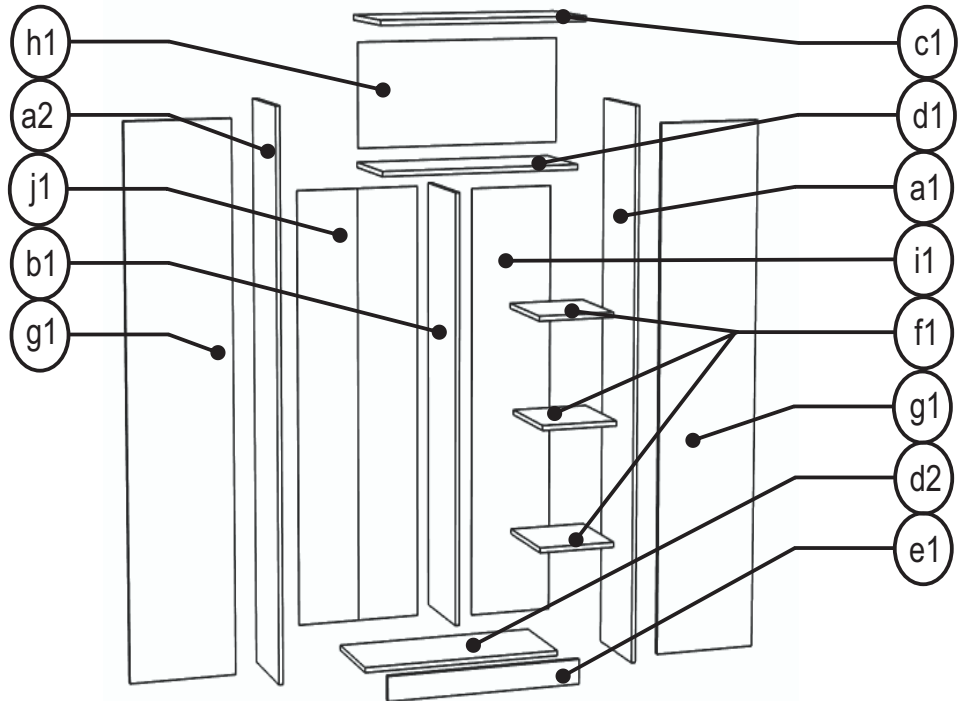
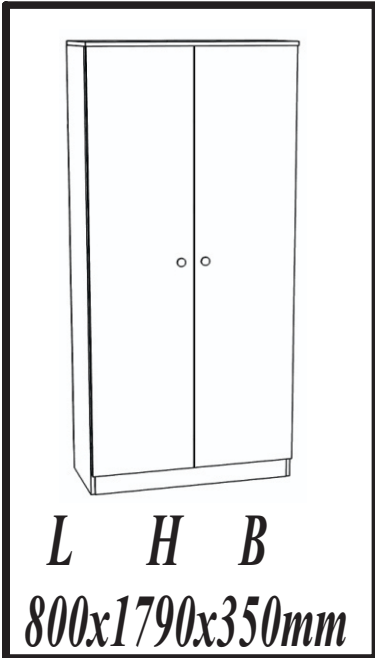
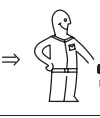
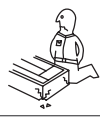

1	a1	1769mm x 330mm x 16mm	1	1/1
2	a2	1769mm x 330mm x 16mm	1	1/1
3	b1	1350mm x 330mm x 16mm	1	1/1
4	c1	803mm x 350mm x 16mm	1	1/1
5	d1	768mm x 330mm x 16mm	1	1/1
6	d1	768mm x 330mm x 16mm	1	1/1
7	e1	768mm x 80mm x 16mm	1	1/1
8	f1	300mm x 330mm x 16mm	3	1/1
9	g1	1690mm x 397mm x 16mm	2	1/1
10	h1	798mm x 330mm x 3.2mm	1	1/1
11	i1	1373mm x 238mm x 3.2mm	2	1/1
12	j1	1373mm x 320mm x 3.2mm	1	1/1

0 10 20 30 40 50 60 70 80 90 100 110 120 130 140 150 160 170 180 190

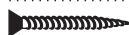

festziehen / tighten / Затягивать /
sieren / stringere / utáhnout / vastitokken /
zategnuti / stránger / zwiáczac / zacisnit'se
szorosan meghúzni / pevne dotiahnut /
tržno pritegniti / sarynyty / dra et

eindrücken / press in / enfoncez / wcisnąć
ribattere / zatláči / Bopapáne / indrücken
benyomni / stlači / vísiniti / tryck in
introducere prin apăşare / adăşir.

auss messen / measure / mēsurer /
misurare / opmeten / izmeriti / miara /
kimēmi / izmēni / māsurare / vsmepit'e
zmeřit / vsmepere / mēsi upp / zmierzyc



drücken / press / presser / staknout /
Haticuvēni vītiniti / nasinac / drukken /
pritisnuti / nacinac / pritisniti / nakaz'ty /
(meg)nyomni / apăşare / tryck fast / nacinac





einschlagen / hammer in / beverni / sla in
frágger au marteau / infósare / Zabit' /
zarazit' / Håðáttre / zabit' / wbić
introducere prin bálate / zabir'ty / zalouct

Drehen - wänden / przekreć - odwrócić /
Keren - omđrááten / Girare - Ruotare /
Okrenuti - ubrnuti / Retoursner - renverser /
Turn over - tun around / Oócite - obrátte /
Sausurere - oöwētere / Obrnite list /
Intoarceş - rotij / Vrtit rúni - vánd /
проокрутіть - oöwēpērt' / otóciť - obrátit
eforgatni - megfordítani

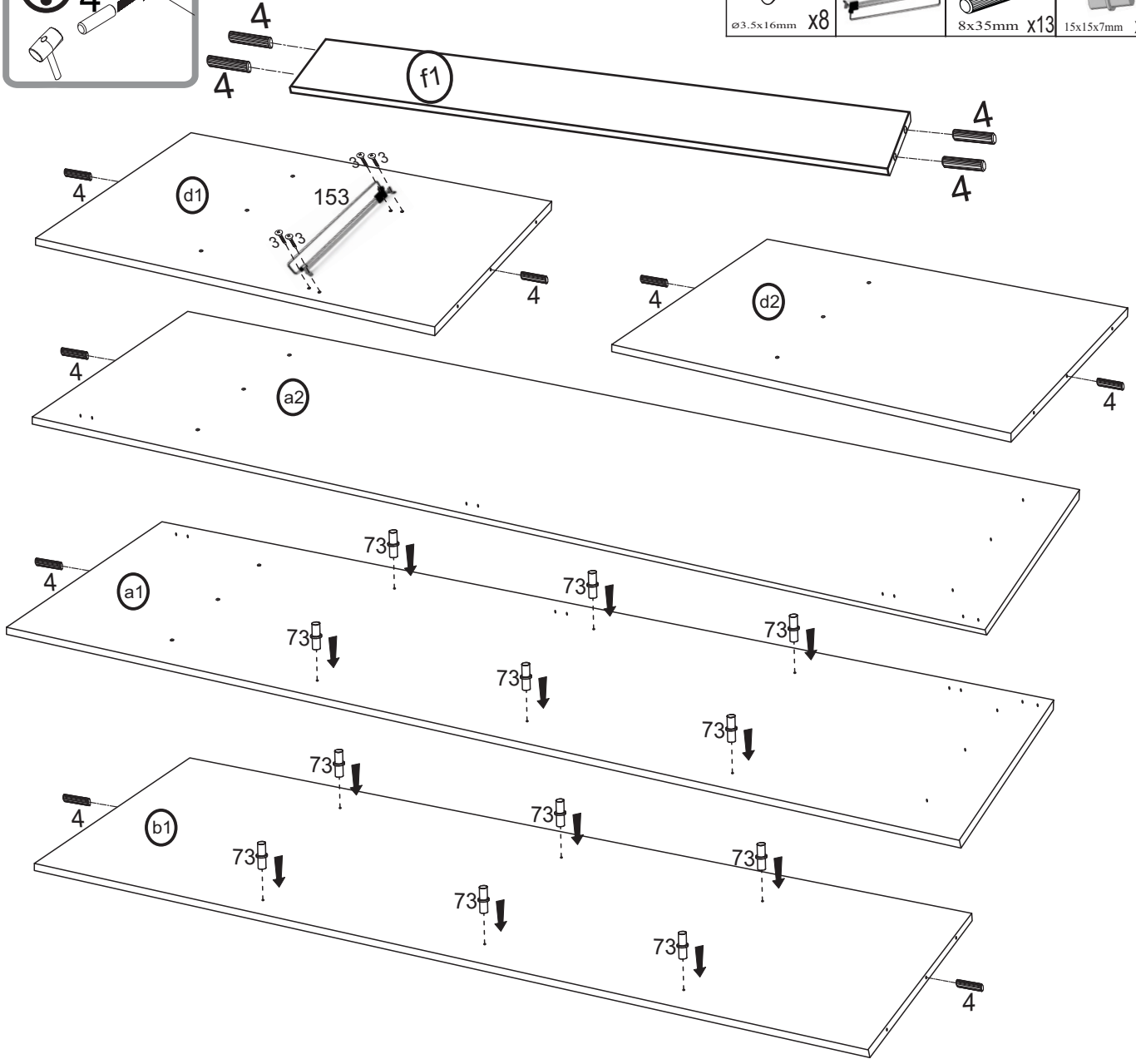
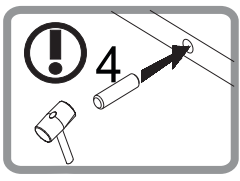
4 Ø8x35mm x12	5 Ø7x50mm x16	3 Ø3.5x16mm x60	47 Ø8mm x10	43 90x10x30mm x1
15 6x70mm x1	16 Ø8x50mm x1	25 x4	153 250mm x1	86 x2
33 (+) 4.0x35 x2	7 x2	10 Ø6.3x11mm x8	58 18x14x2mm x10	39 (+) 3.5x25 x10
73 15x15x7mm x12	IMBUS 4mm x1			

0 10 20 30 40 50 60 70 80 90 100 110 120 130 140 150 160 170 180 190



- | | | | |
|---|--|--|--|
| 7 | 3 | 33 | 86 |
|  |  |  |  |
| x6 | ∅3.5x16mm X12 | 4.0x25mm X4 | x2 |

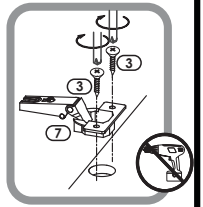
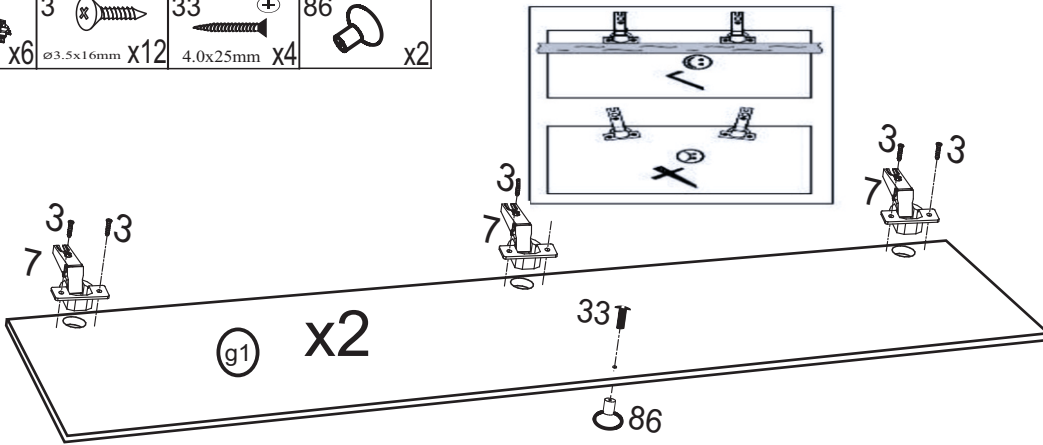

- | |
|--|
| 5 |
|  |
| ∅7x50mm X15 |

