

UNIT 1800/2346

01	915x506x16	1/1
02	915x322x16	1/1

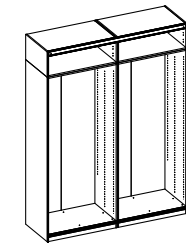

+

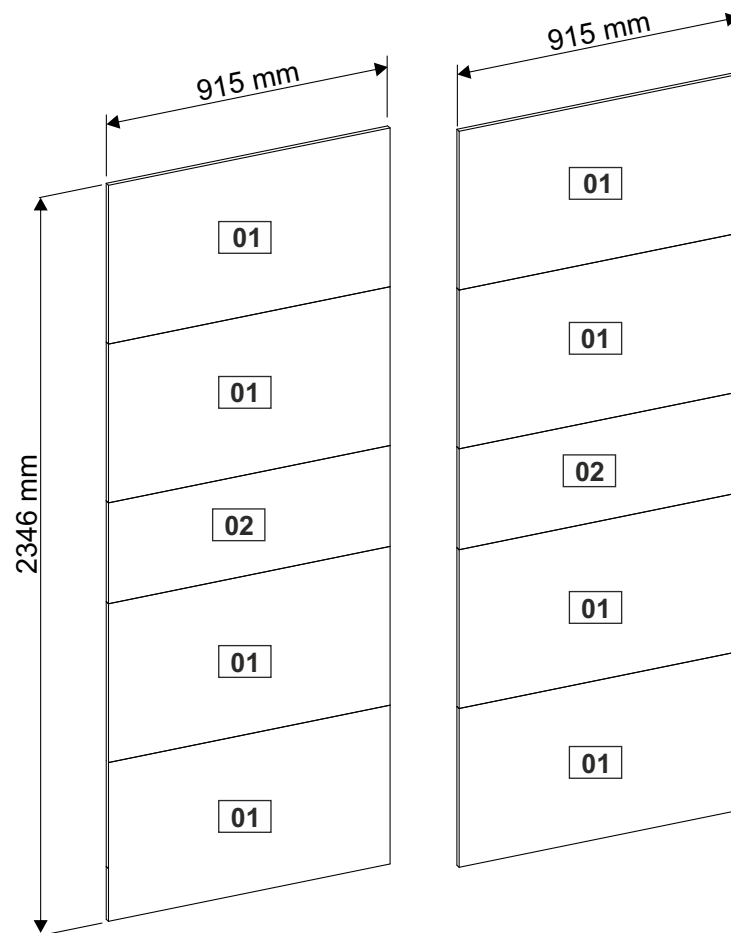
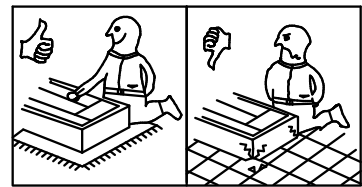
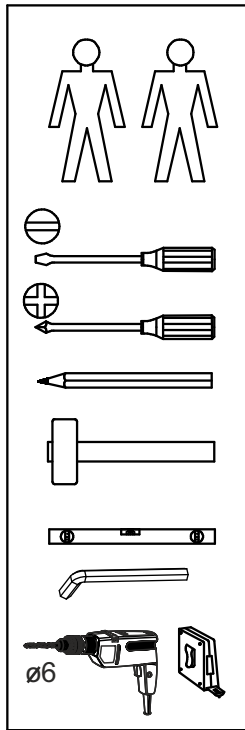
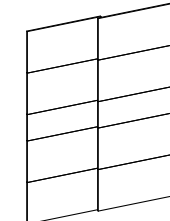

=

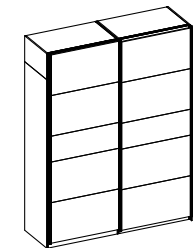

UNIT 1800/2346

C 1/1

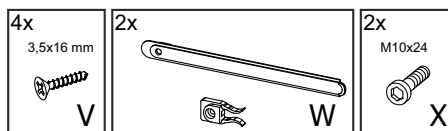
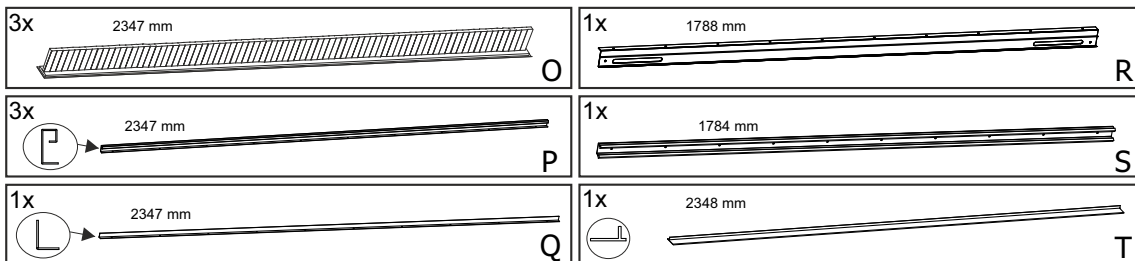
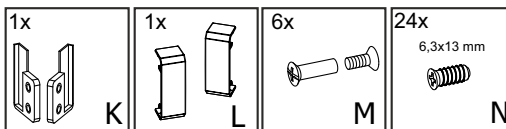
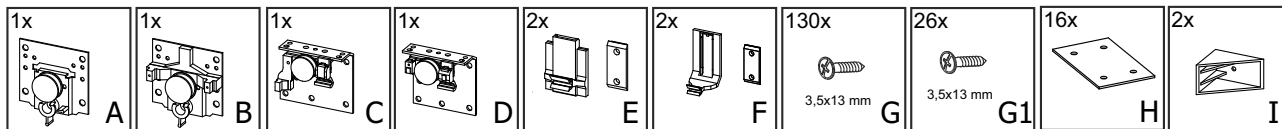

UNIT 1800/2346

1

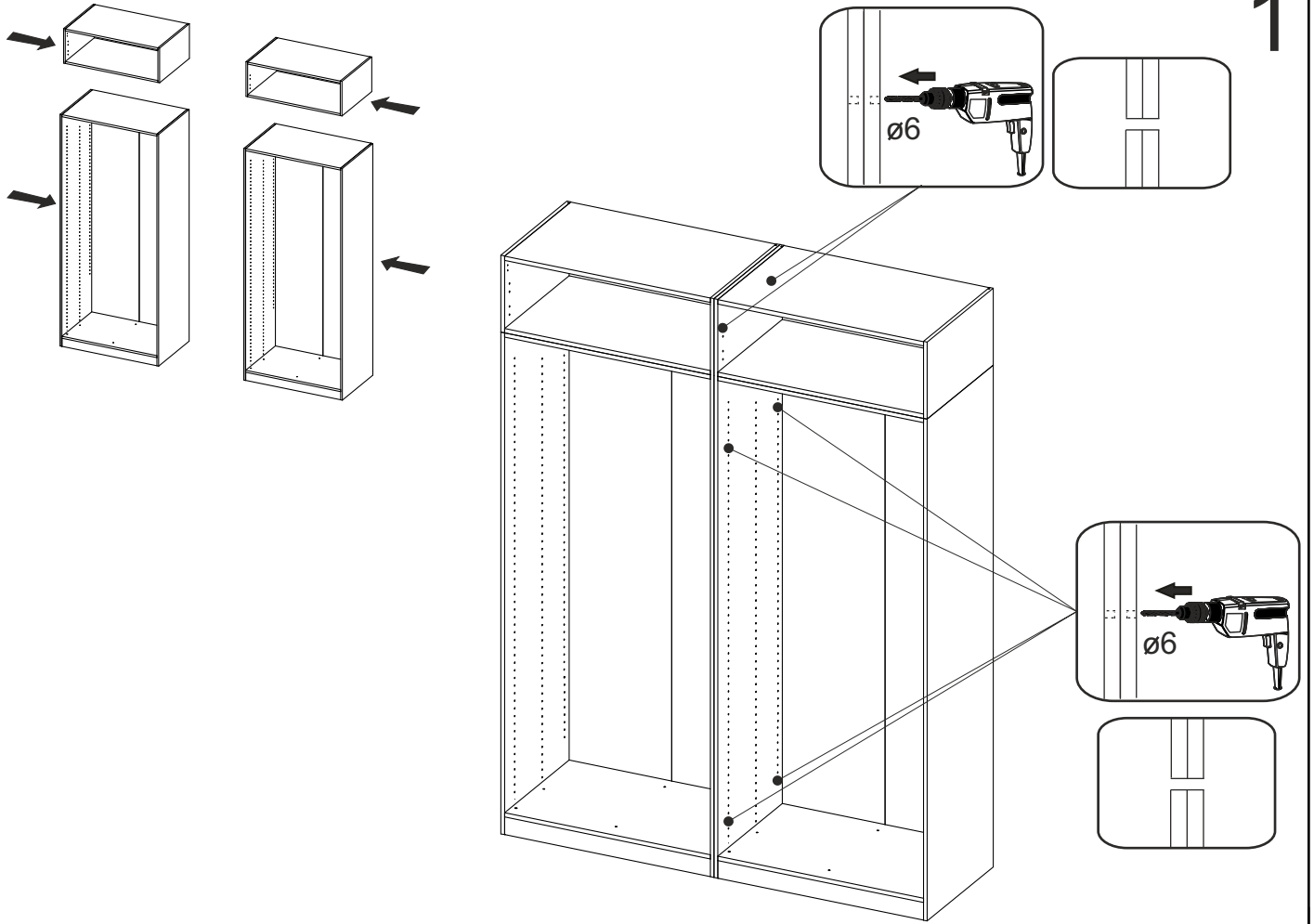

2

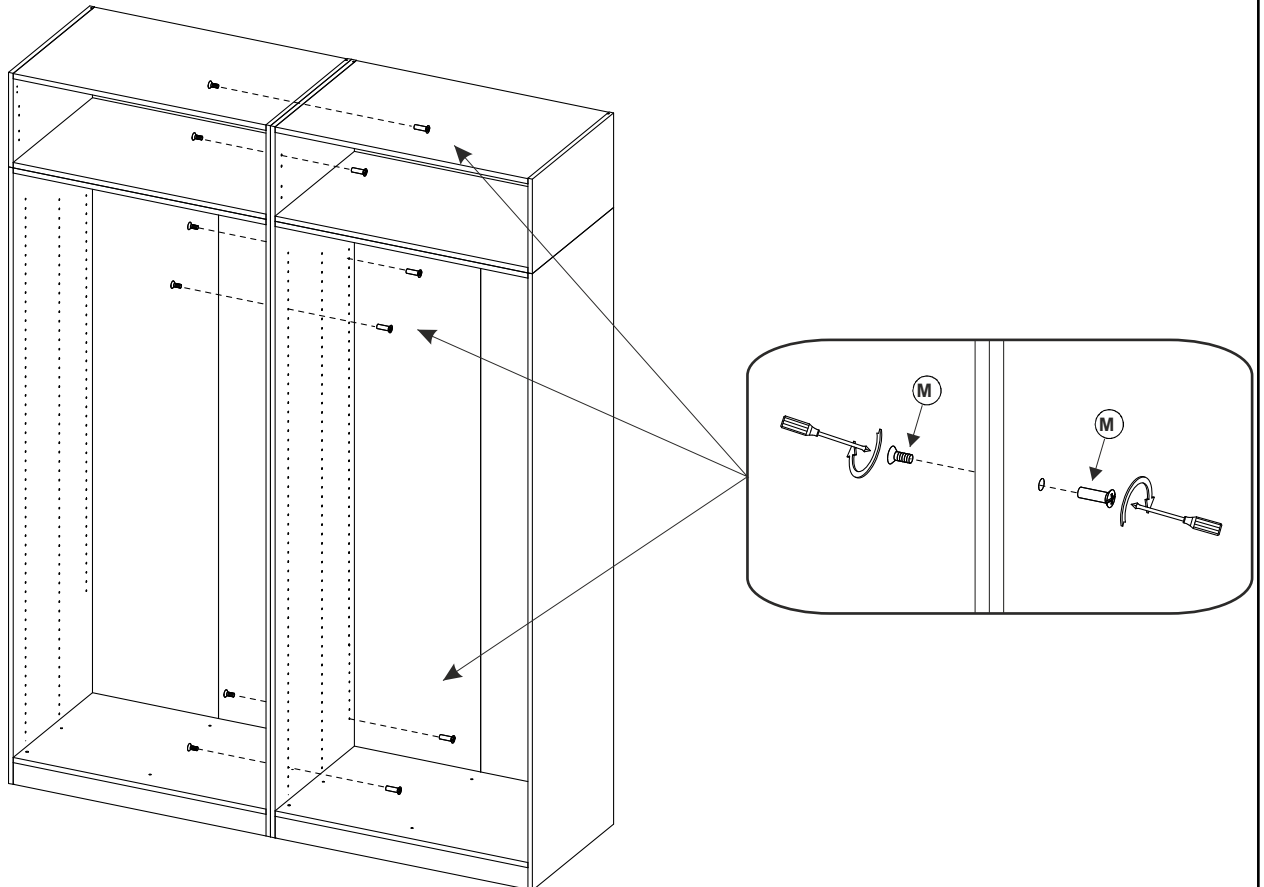
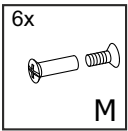

UNIT 1800/2346

3

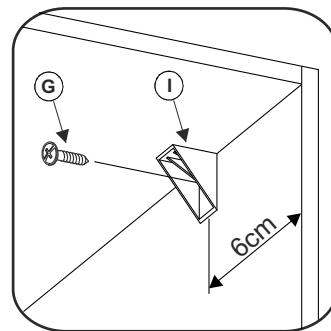
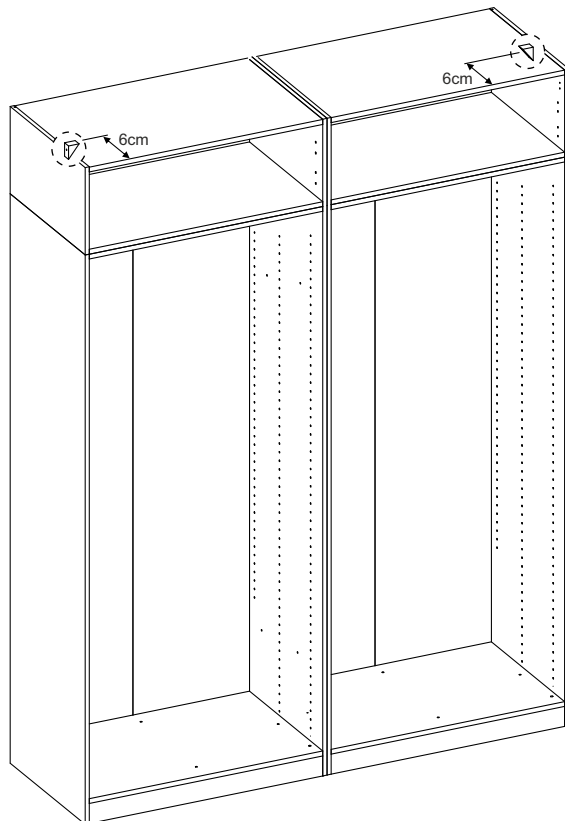
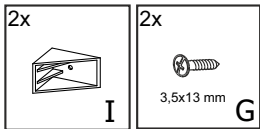

4

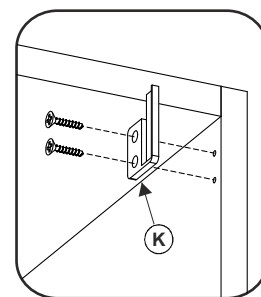
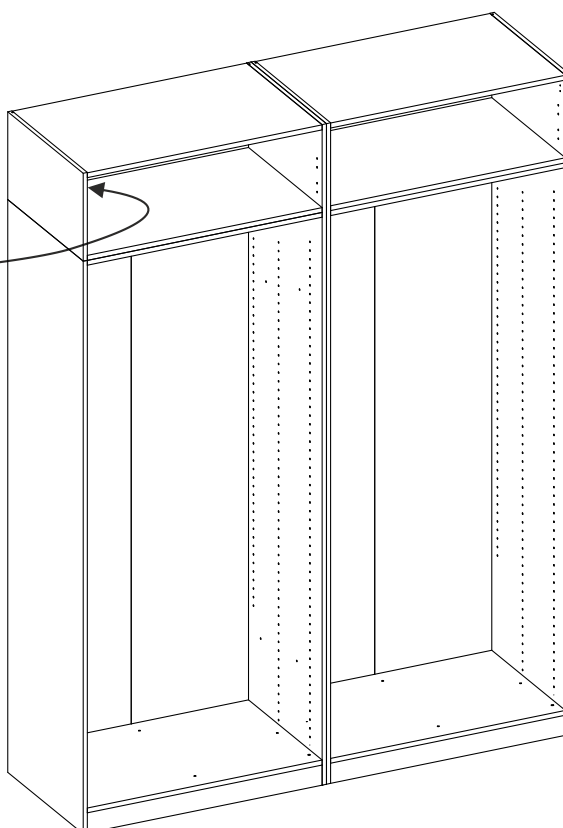
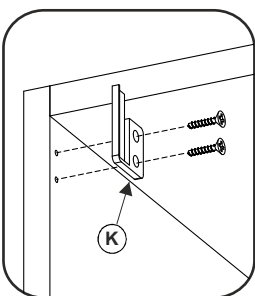
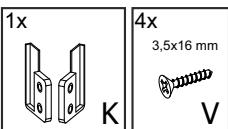

UNIT 1800/2346

5

8x
3,5x13 mm
G

1x 2025 mm
R

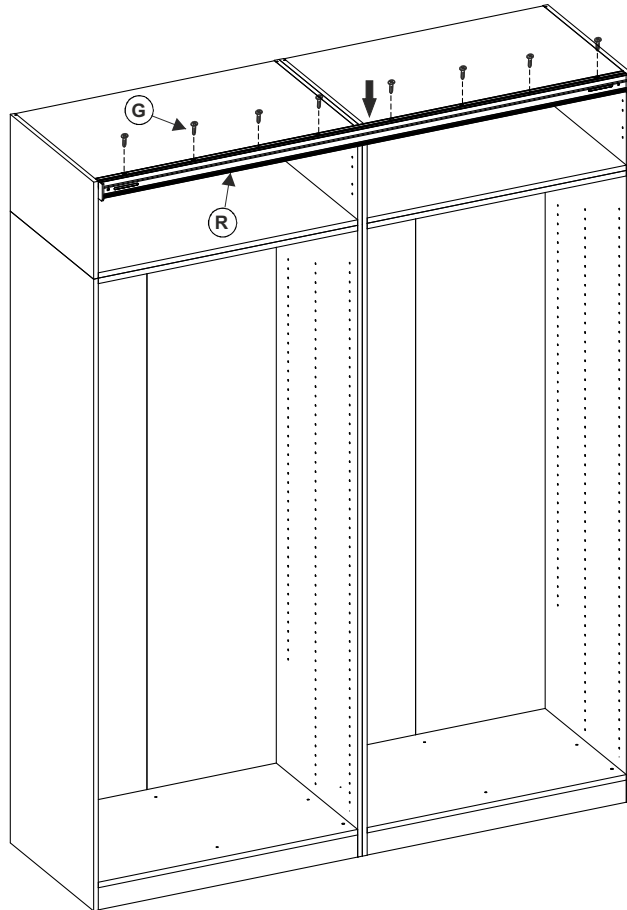
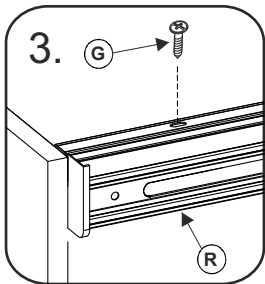
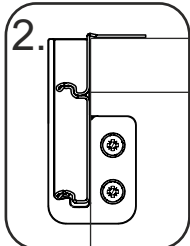
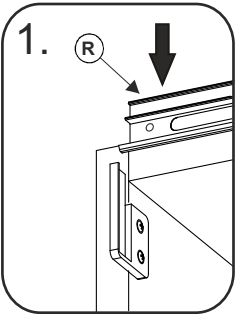

6

2x
W

2x
M10x24
X

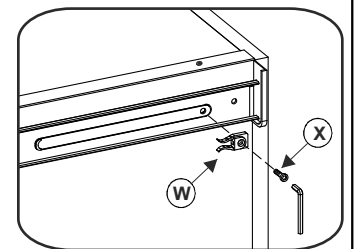
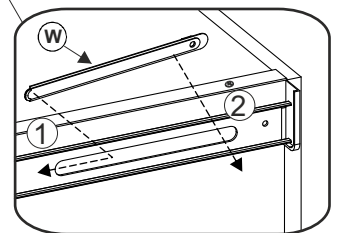
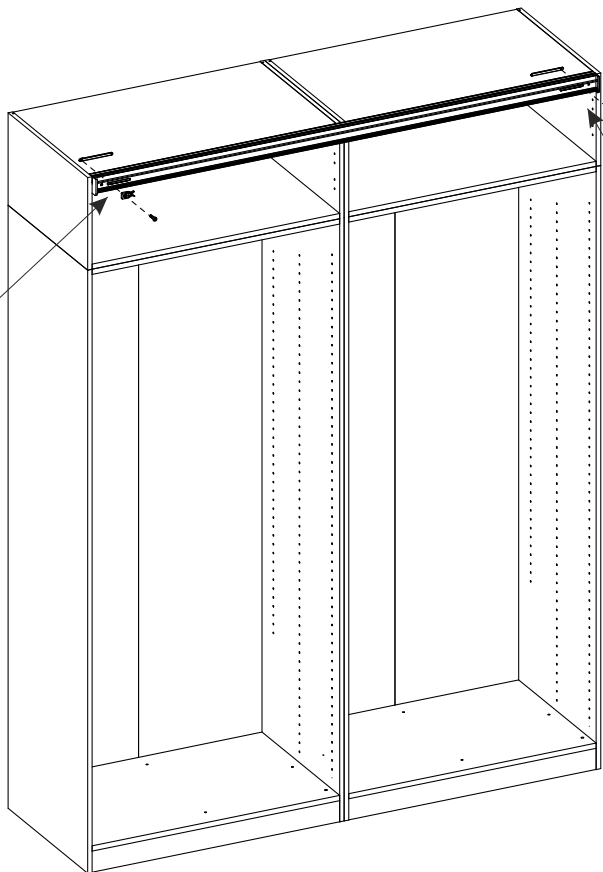
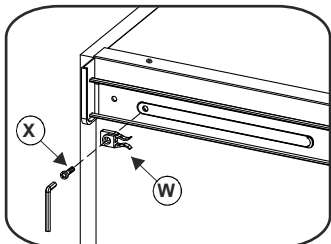
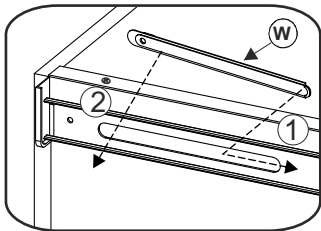

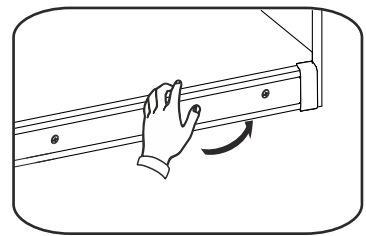
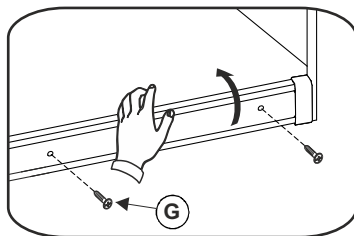
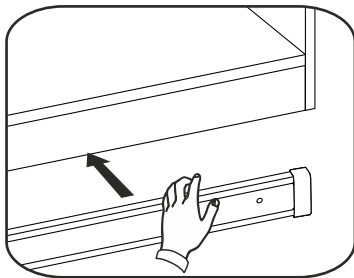
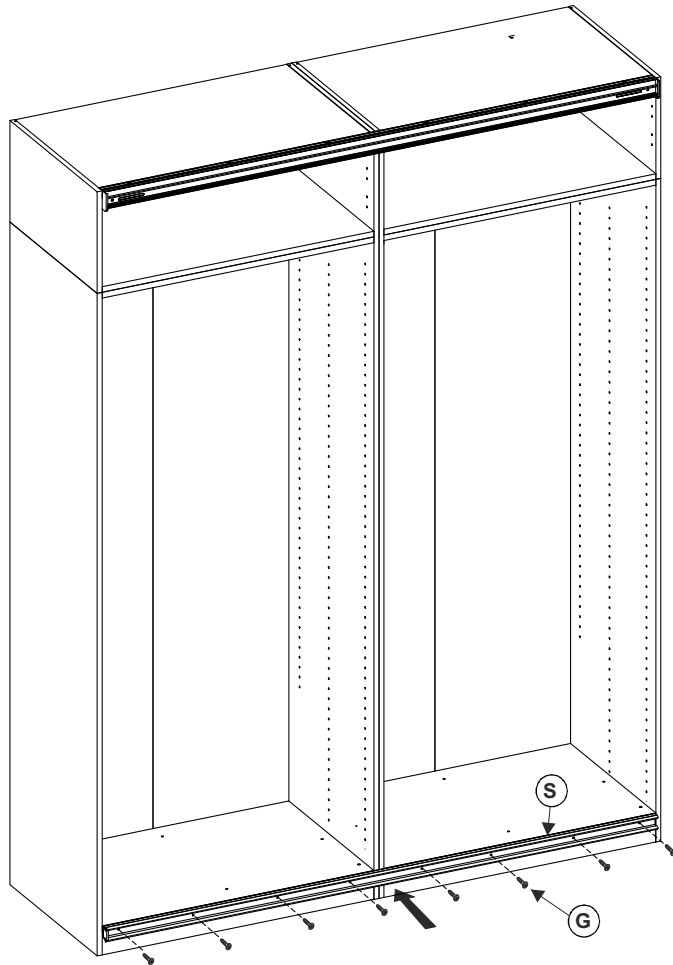
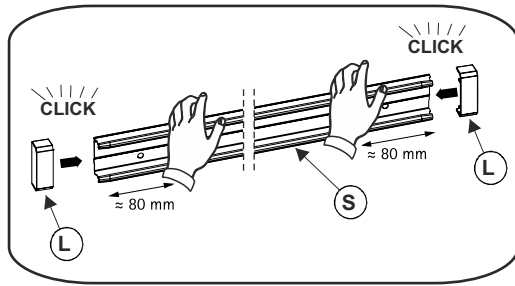
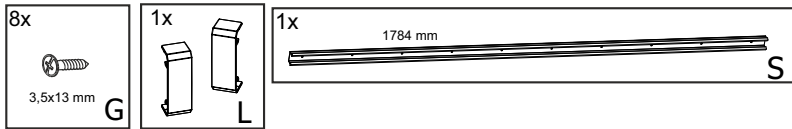

A=B

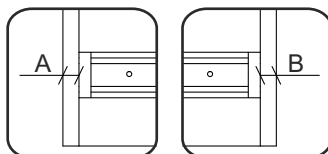

8

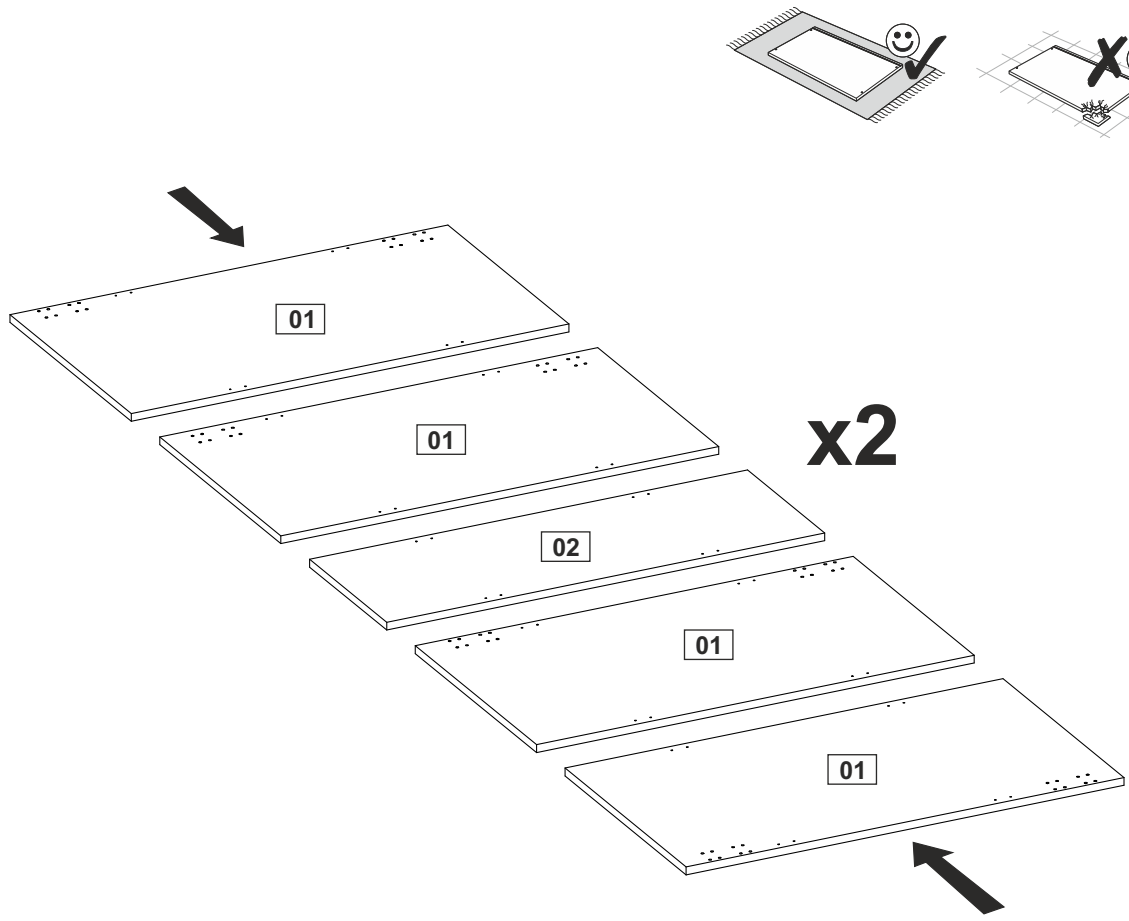

9

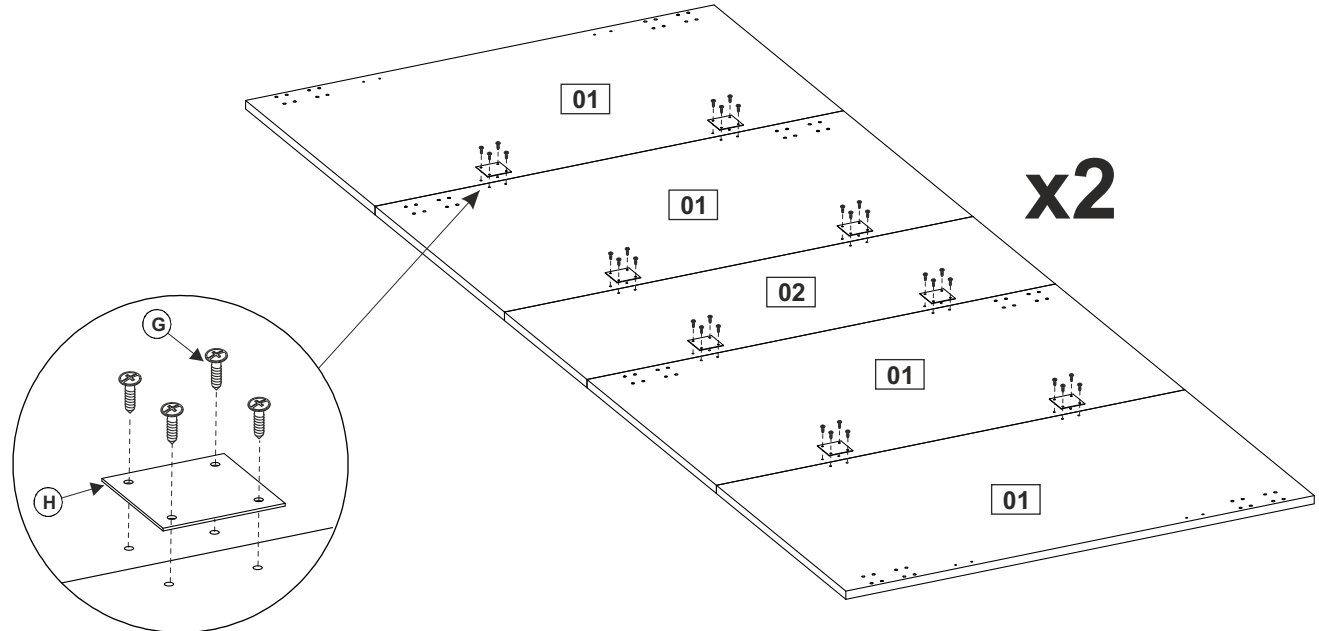
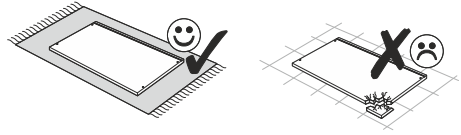
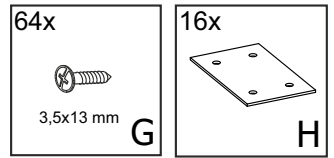

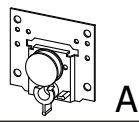
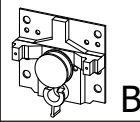
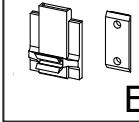
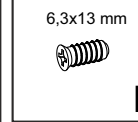

UNIT 1800/2346

10

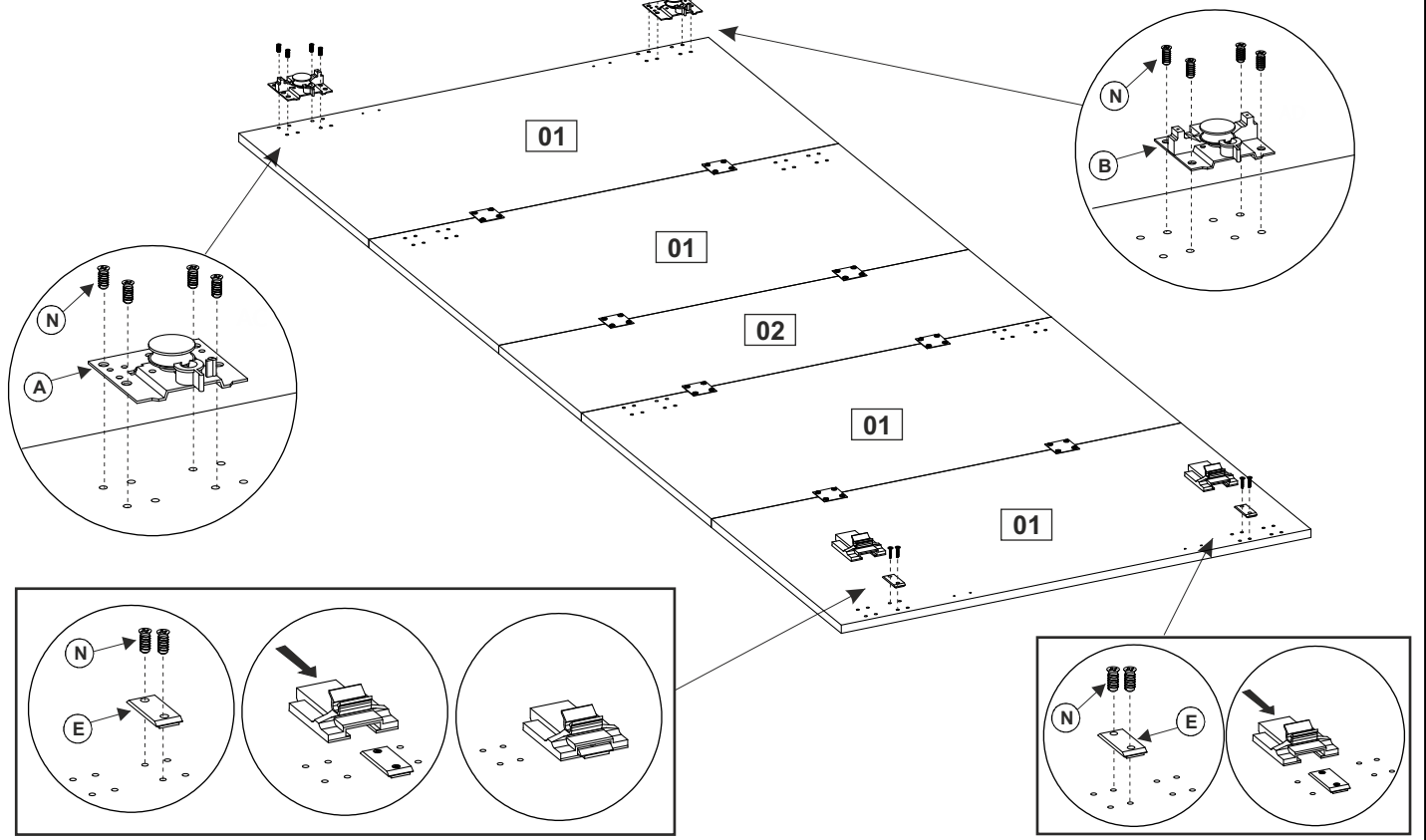
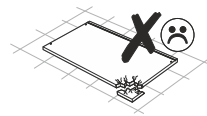
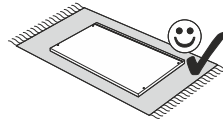
- 1x  A
- 1x  B
- 2x  E
- 12x  N
6,3x13 mm



11

- 1x  P
2347 mm
- 1x  Q
2347 mm

- 24x  G
3,5x13 mm

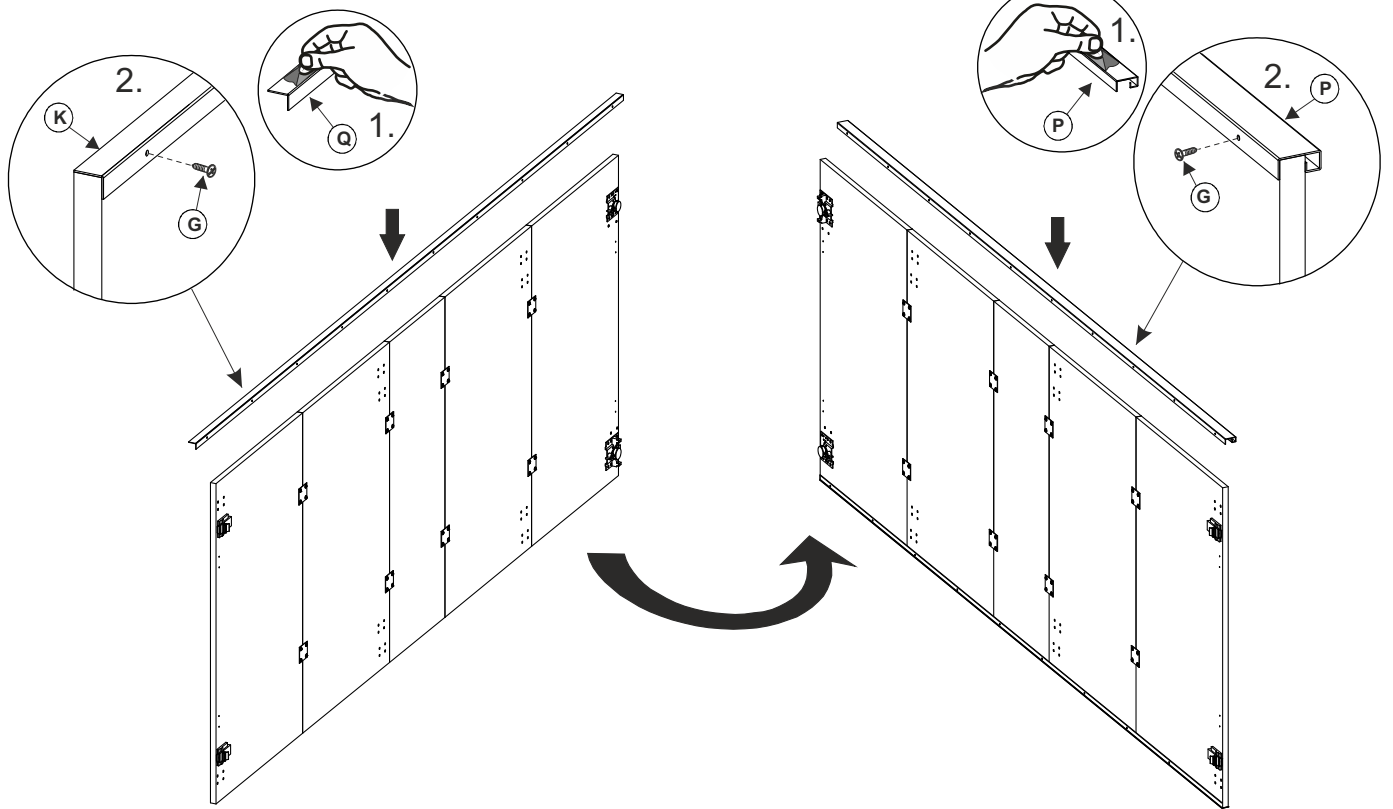
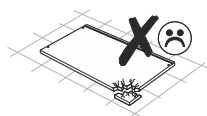
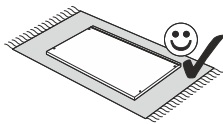

UNIT 1800/2346

12

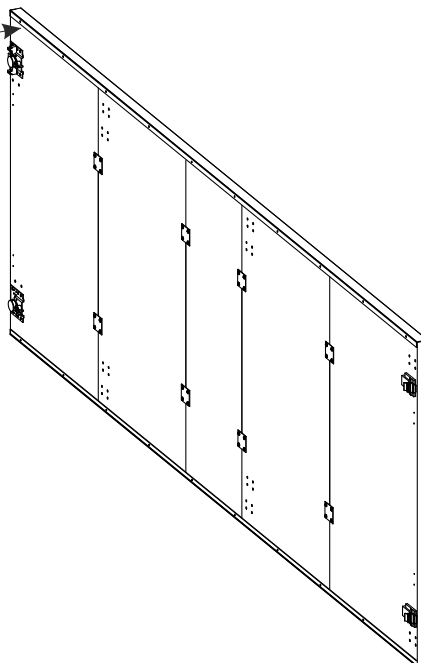
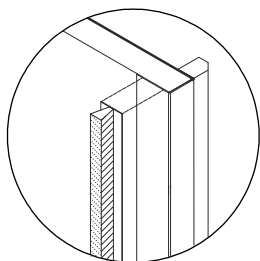
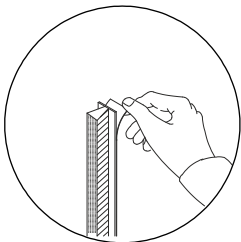
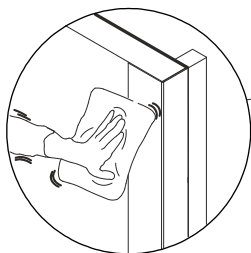
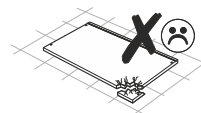
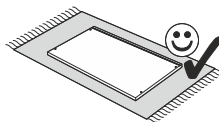
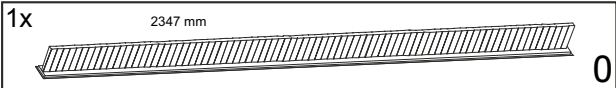

13

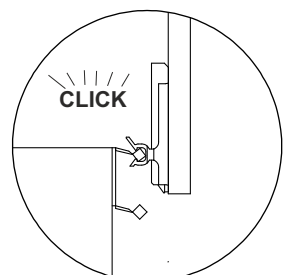
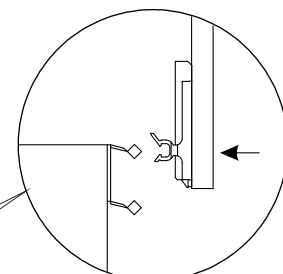
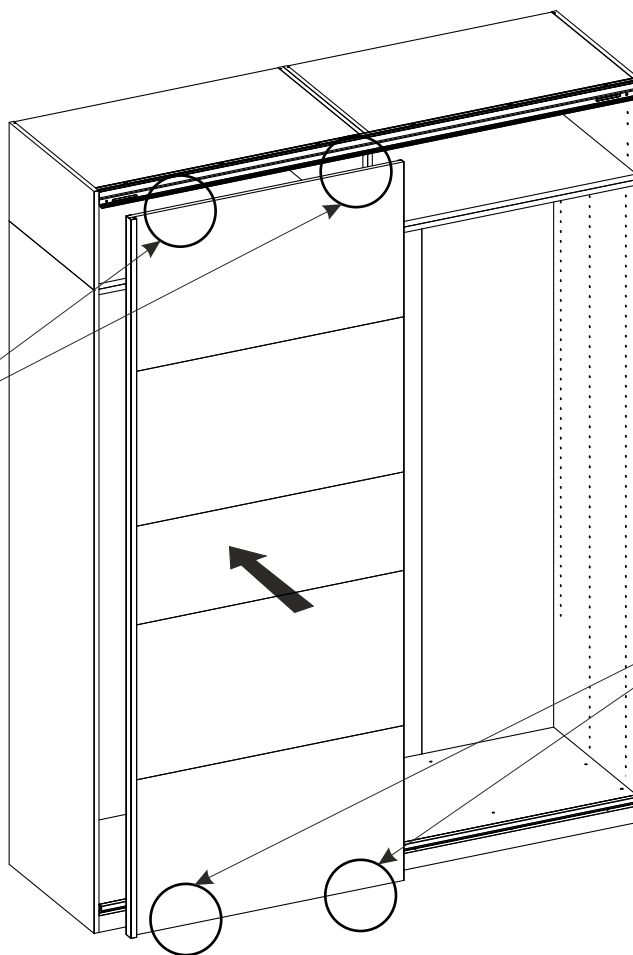
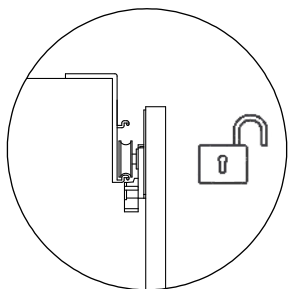
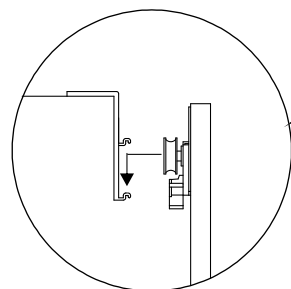

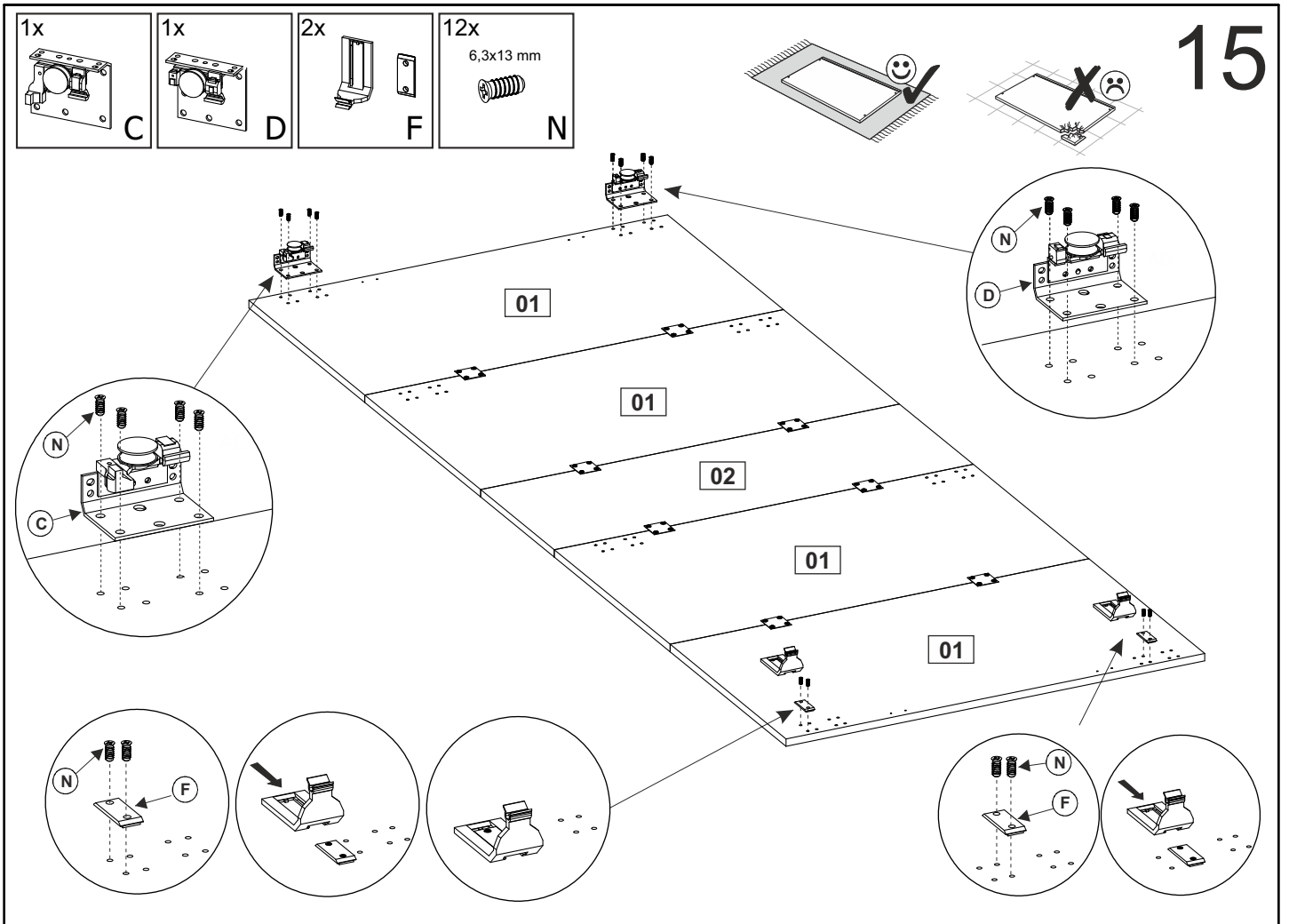
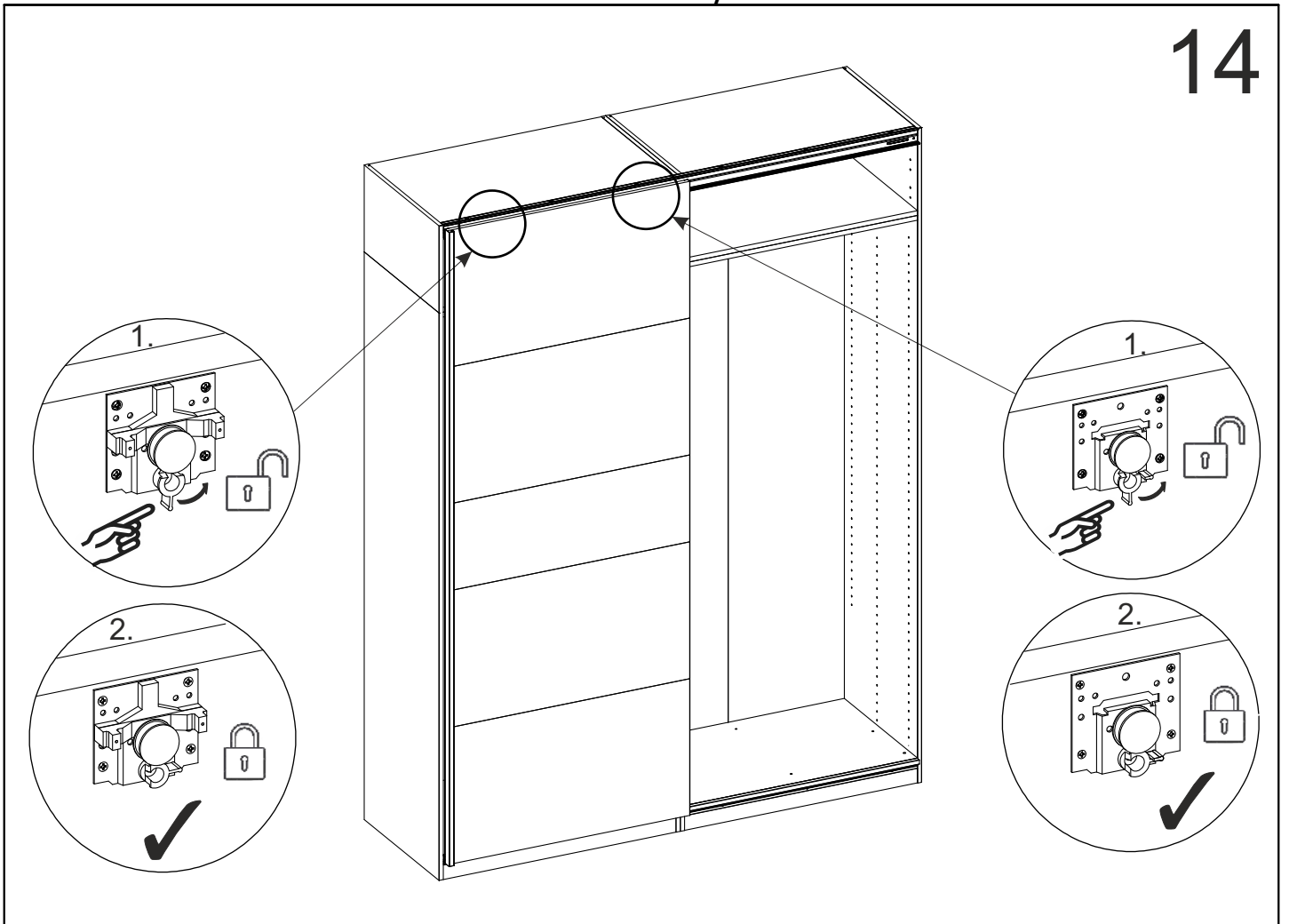

UNIT 1800/2346

16

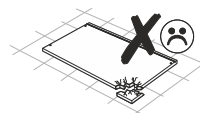
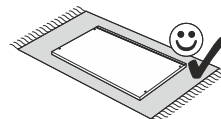
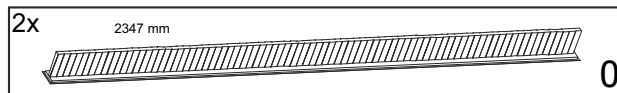
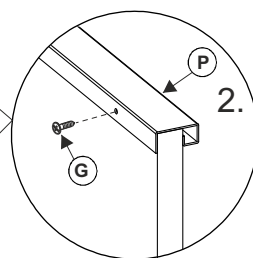
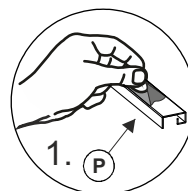
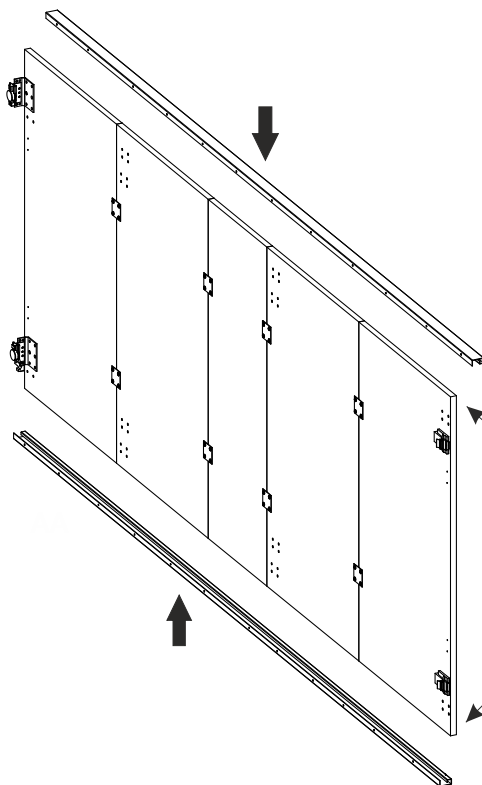
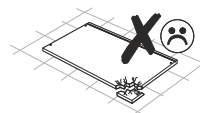
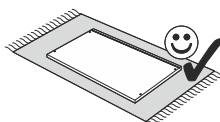
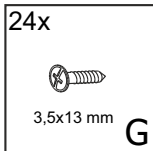

17

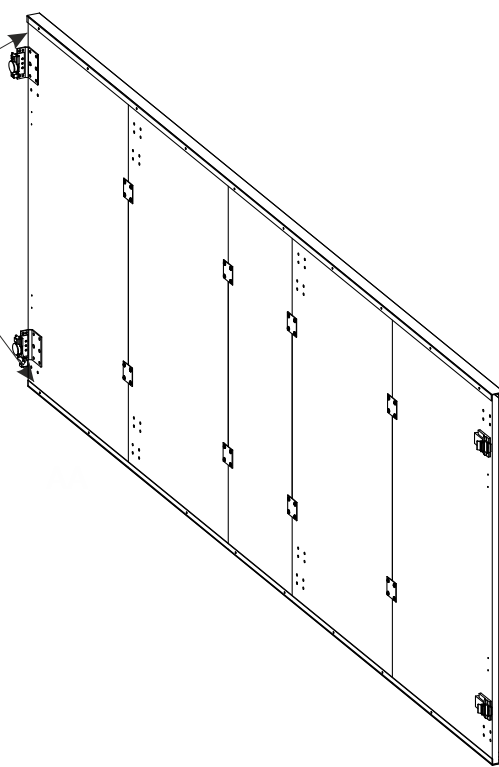
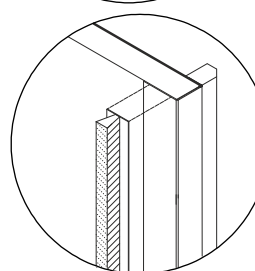
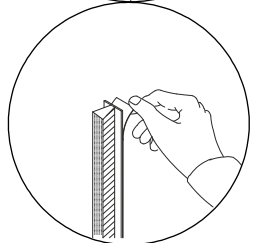
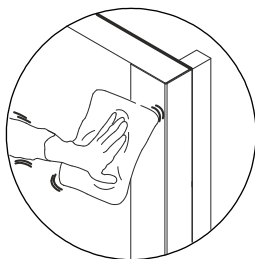

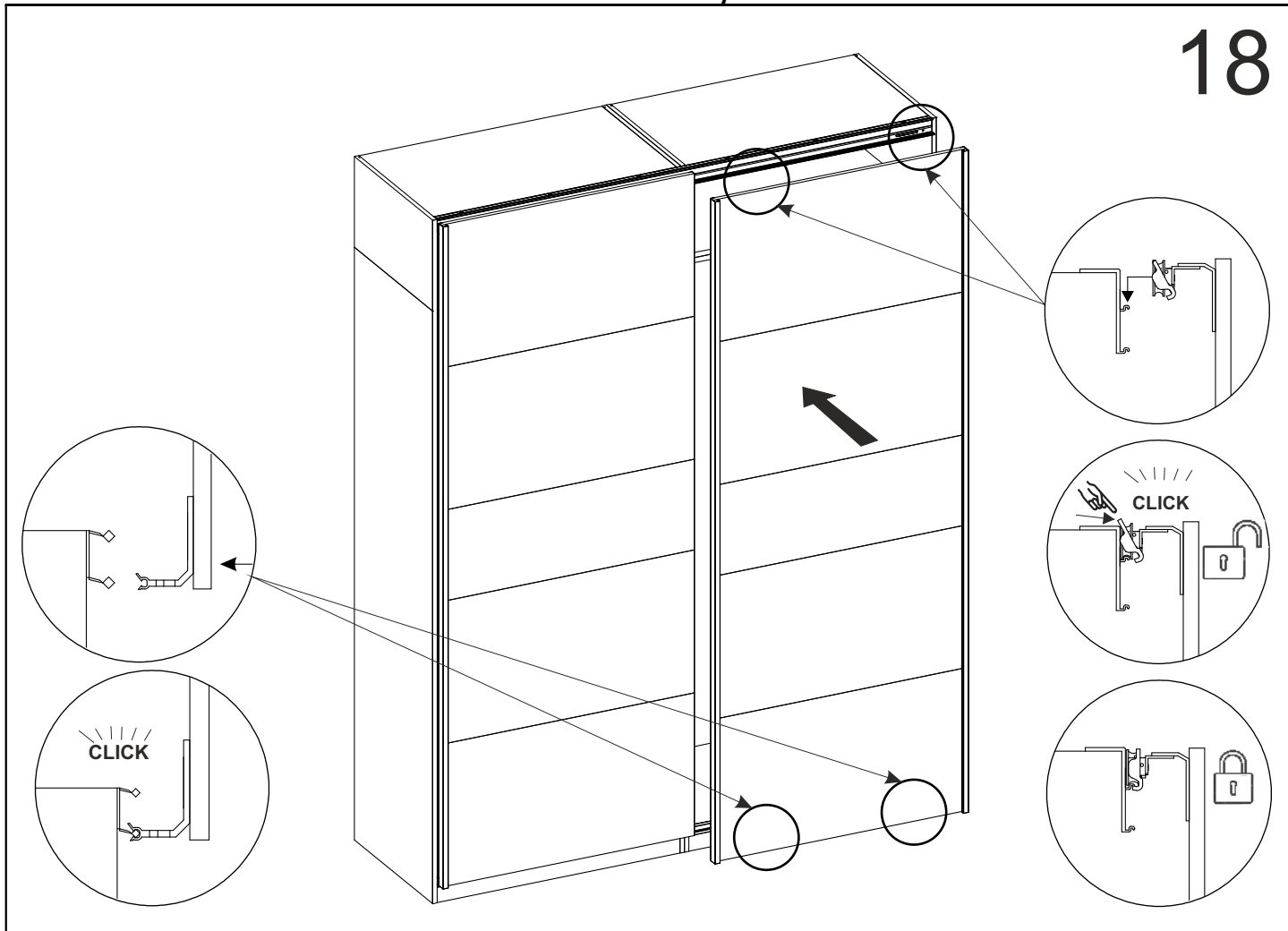

- 1x 2348 mm T
- 1x 2348 mm U

- 26x 3,5x13 mm G1

