

MEET THE OTHER

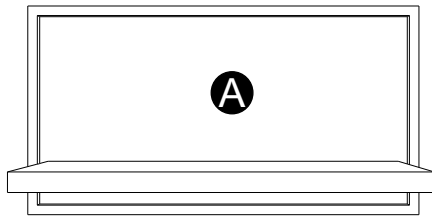

65x25x35 cm

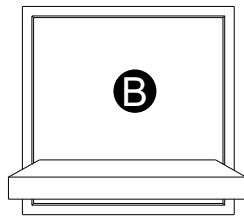

35x25x35 cm

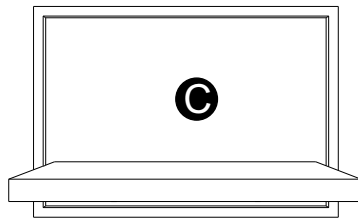

50x25x35 cm

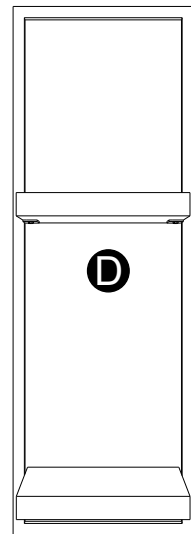

25x25x75 cm

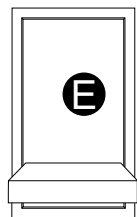

25x25x35 cm

ASSEMBLING INSTRUCTIONS

LET'S GET STARTED!

(check if all parts are in the box)

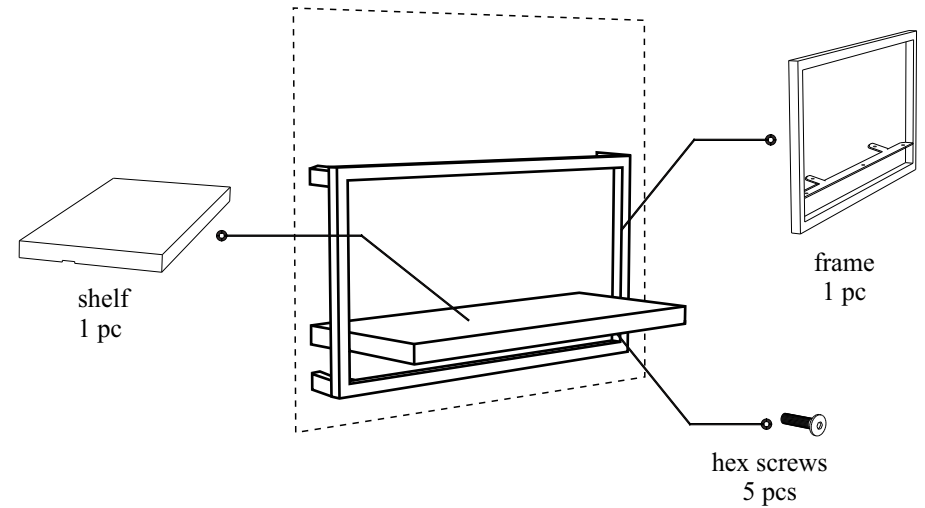

- 1* IDENTIFY THE PARTS.
- 2* MAKE SURE YOU HAVE ALL THE PARTS AND FIXINGS.
- 3* HAVE THE NECESSARY TOOLS READY.
- 4* PREPARE A SPACE FOR ASSEMBLY, IDEALLY WITH A PROTECTIVE BLANKET OR CARPET TO PREVENT DAMAGES.
- 5* ASSEMBLE THE FURNITURE FOLLOWING THE ASSEMBLY INSTRUCTION.
- 6* RE-TIGHTEN THE NUTS, BOLTS AND SCREWS AFTER A PERIOD OF USE

KEEP THE ASSEMBLY INSTRUCTION. IT WILL HELP YOU TO GET IN TOUCH WITH THE SALES DEPARTMENT IN CASE THAT ANY PART MAY BE DEFECTED OR MISSING.

TOOLS YOU NEED TO PREPARE

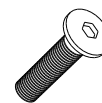

D-nut



allen key
(included)

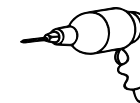

drill

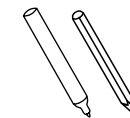

marker / pencil



wall plugs

ASSEMBLING & HANGING

STEP 1

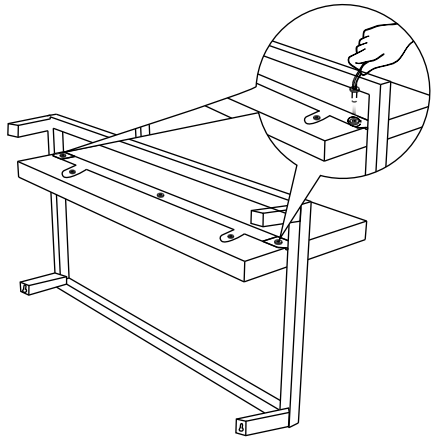

Screw the shelf in its frame as pictured above, then tighten the hex screws

STEP 2

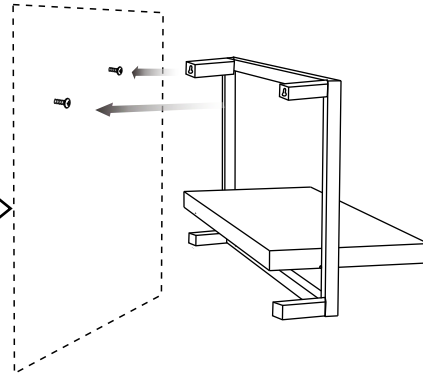

Attach screws to the wall. Hang the SHELF

STEP 3

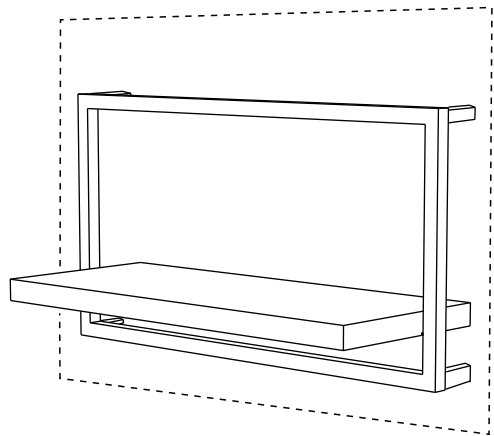

Congratulations!
Your SHELF is ready

HANGING MULTIPLE

MAKE IT EASY, USE THE TOOLKIT

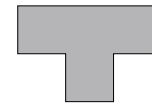

1. MDF measurement Tee will be in carton, use the inside of the box

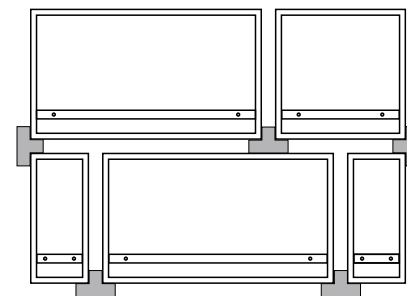

SPACING

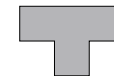

Use the tee to position the SHELF modules towards each other horizontally and vertically