

# *Montageanleitung von sessel*

## *Hugo*

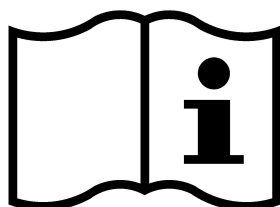

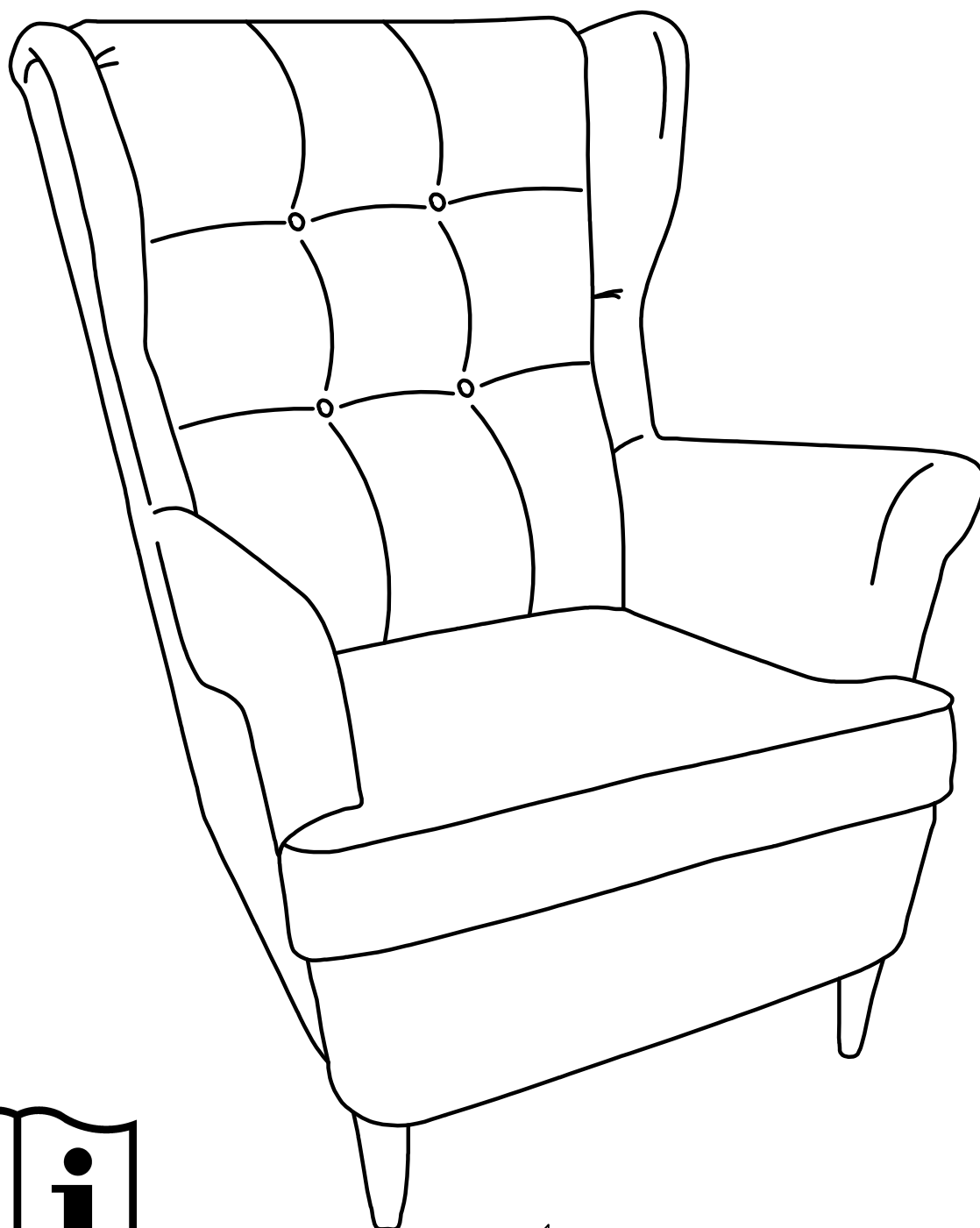

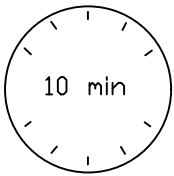



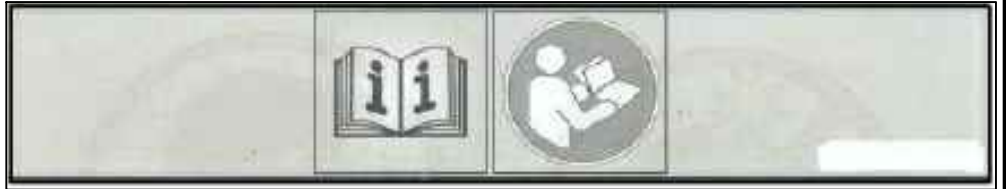

10 min



Schraubenschlüssel 13

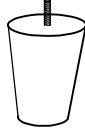

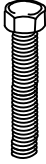
## Elemente in einem Satz

A	B	C	D	E	K
					
L=135 x 2	L=120 x 2	x 4	x 4	M8X65 x 6	M8x 6

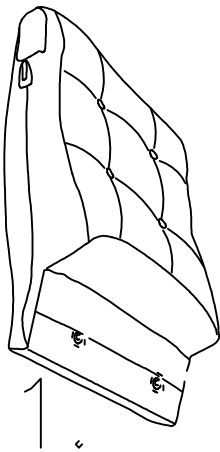

1.

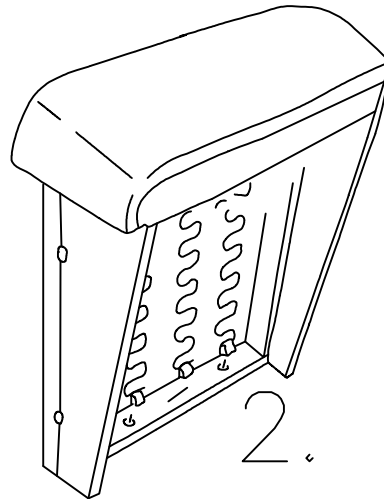

2.

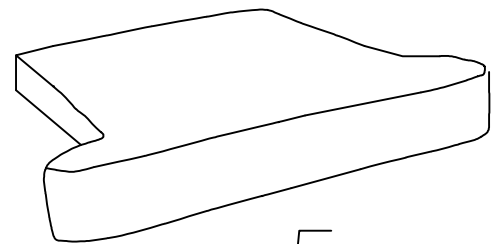

5.

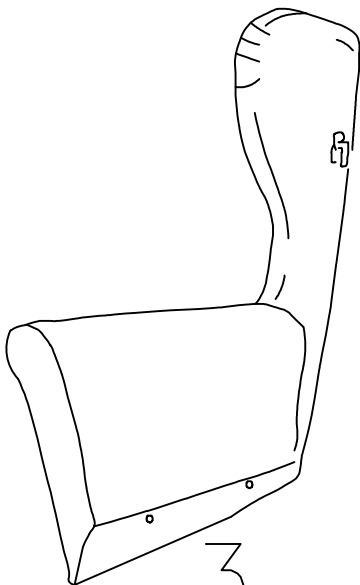

3.

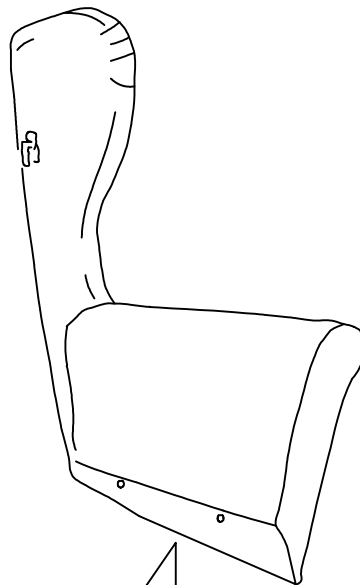

4.

1.

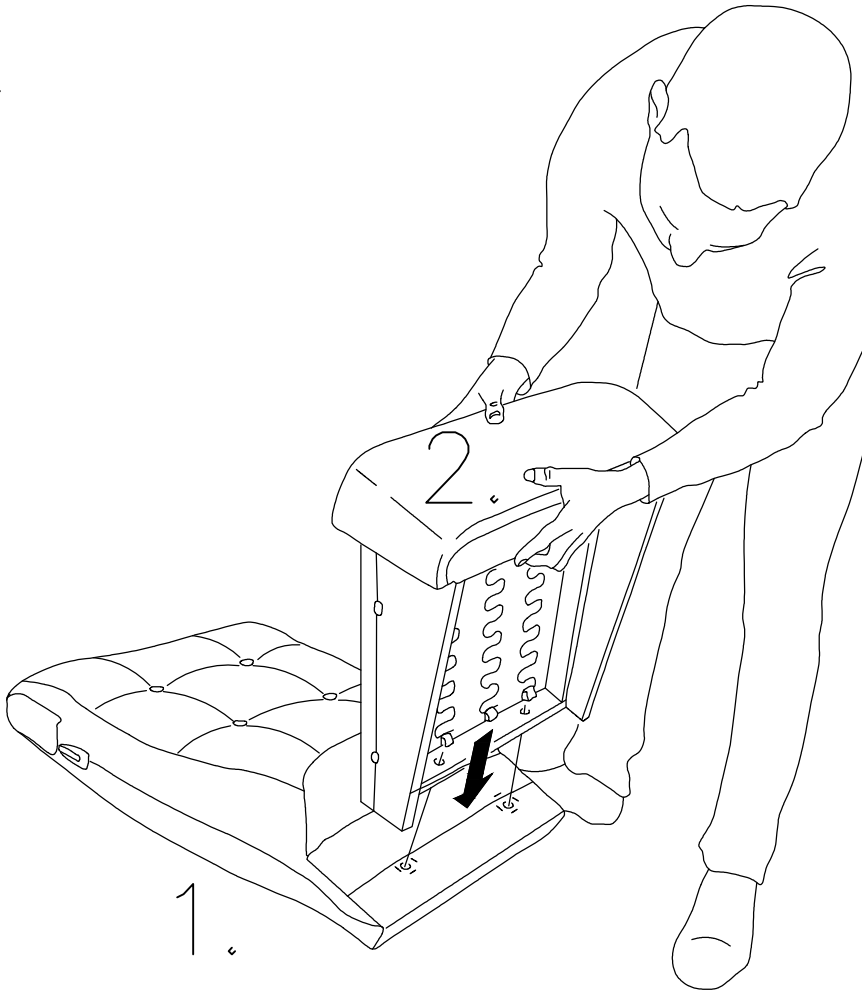
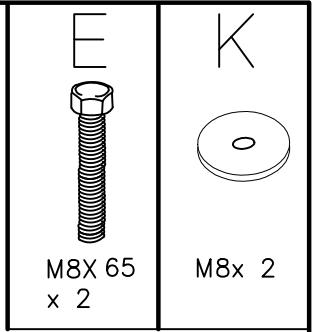

2.

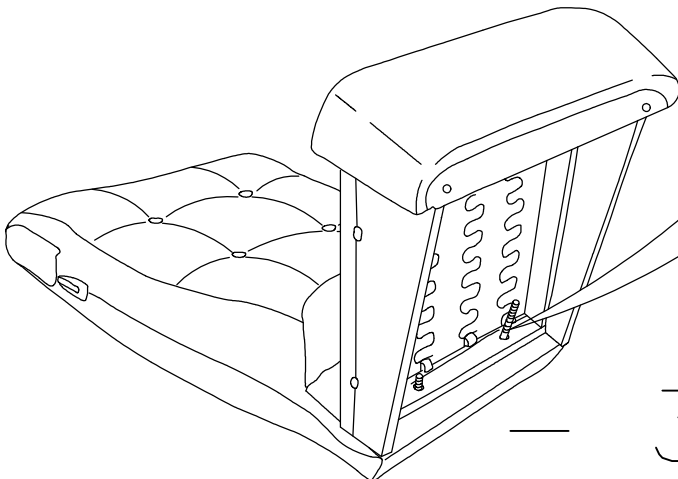
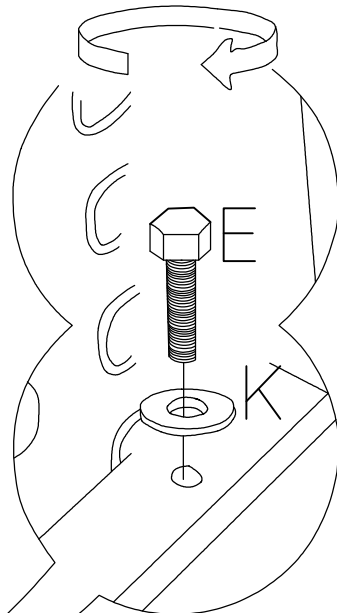

1.



— 3 —

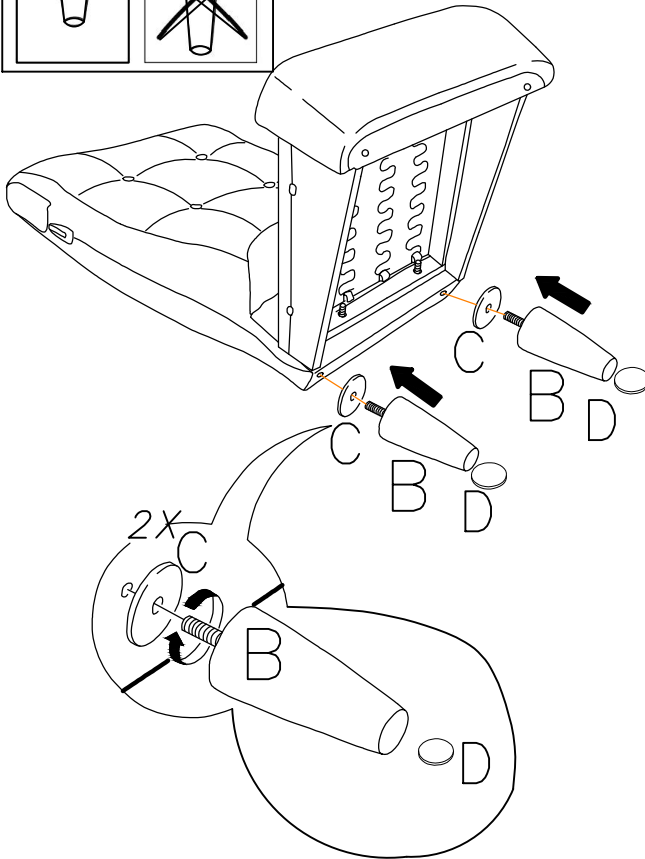
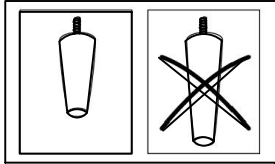

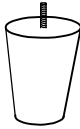
3.

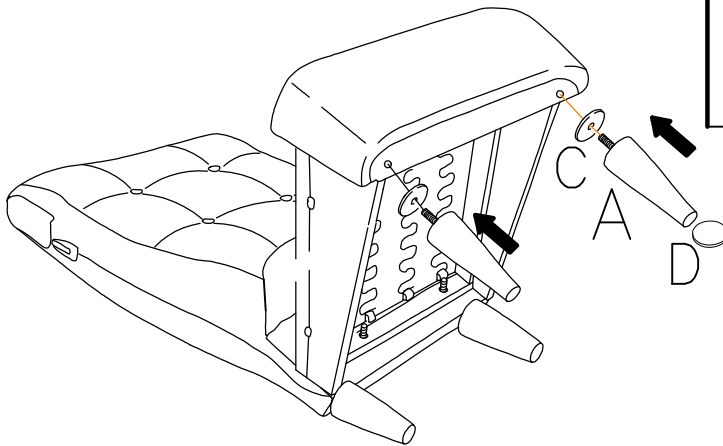

B	C	D
		
L=120 x 2	x 2	x 2

4.



A	C	D
		
L=135 x 2	x 2	x 2

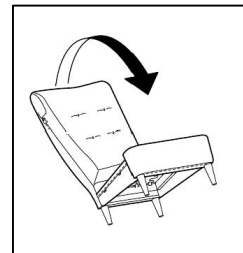
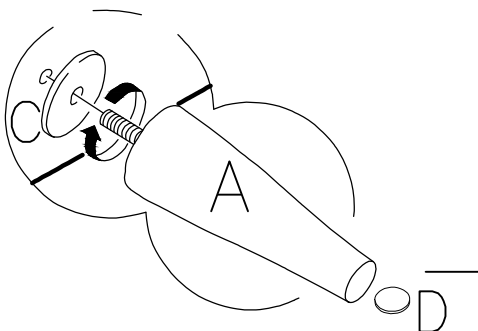

5.

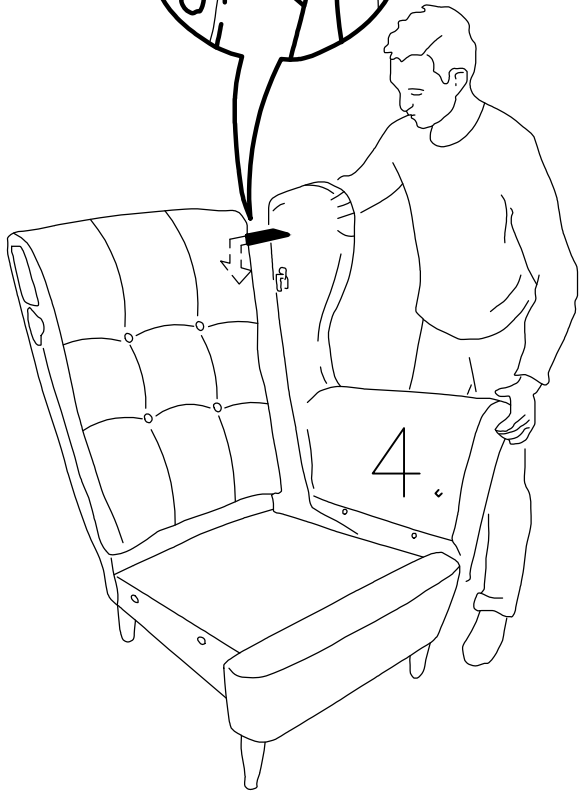
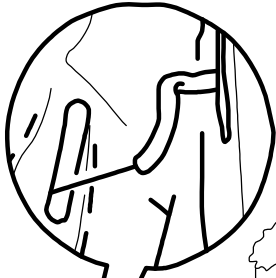

Nr 1  
Einhängebeschlag  
(Rückenlehne)

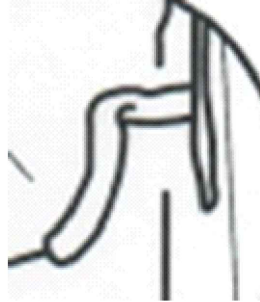

Nr 2  
Aufhänger  
(Gegenstück für  
Einhängebeschlag)

6.

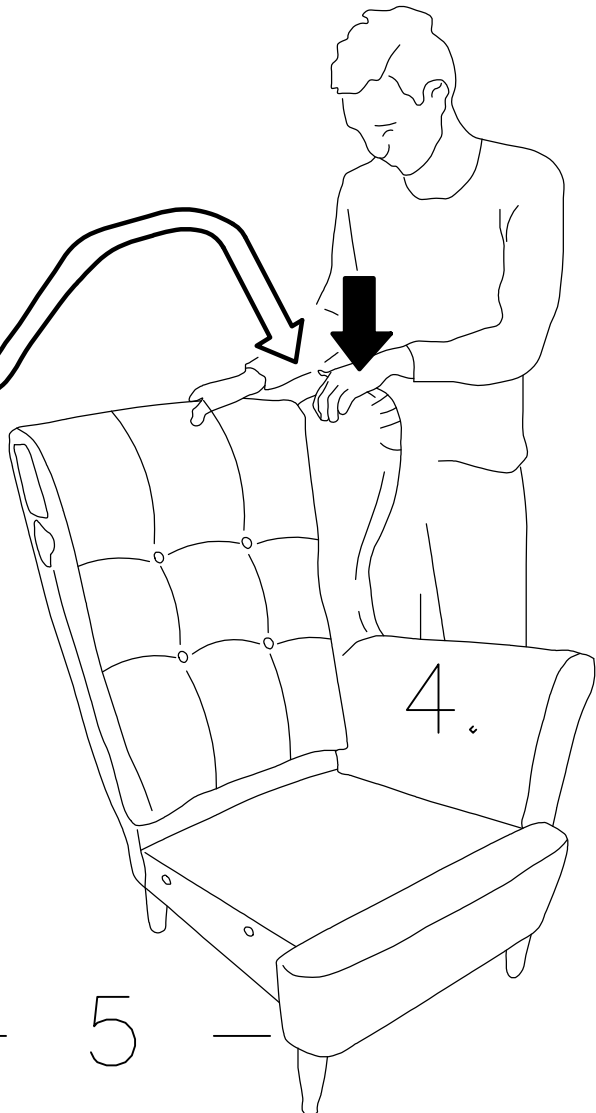
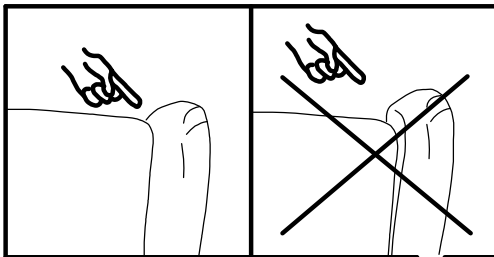

— 5 —

7.

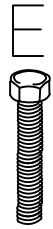
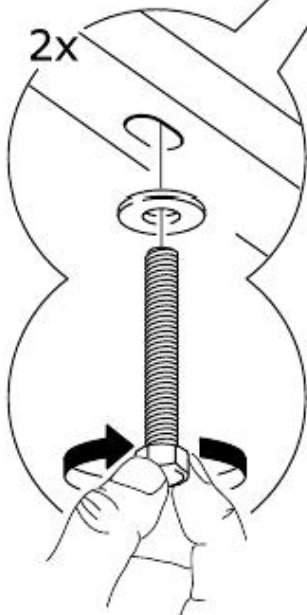
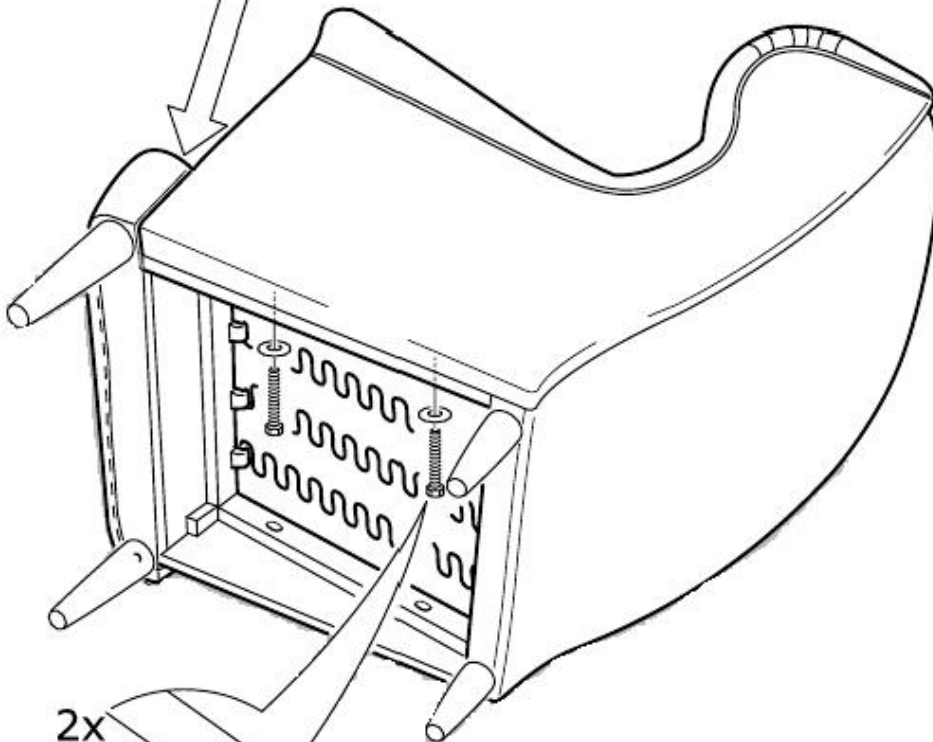
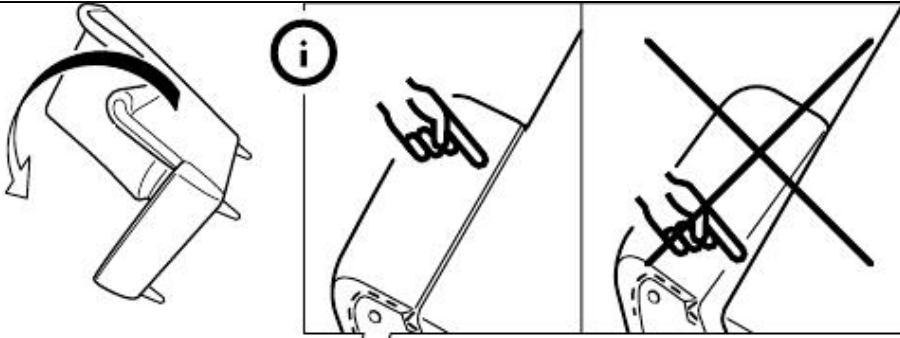

M8X65  
x 2

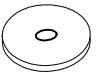

M8x 2

8.

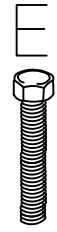

M8X65  
x 2

K

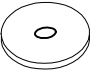

M8x 2

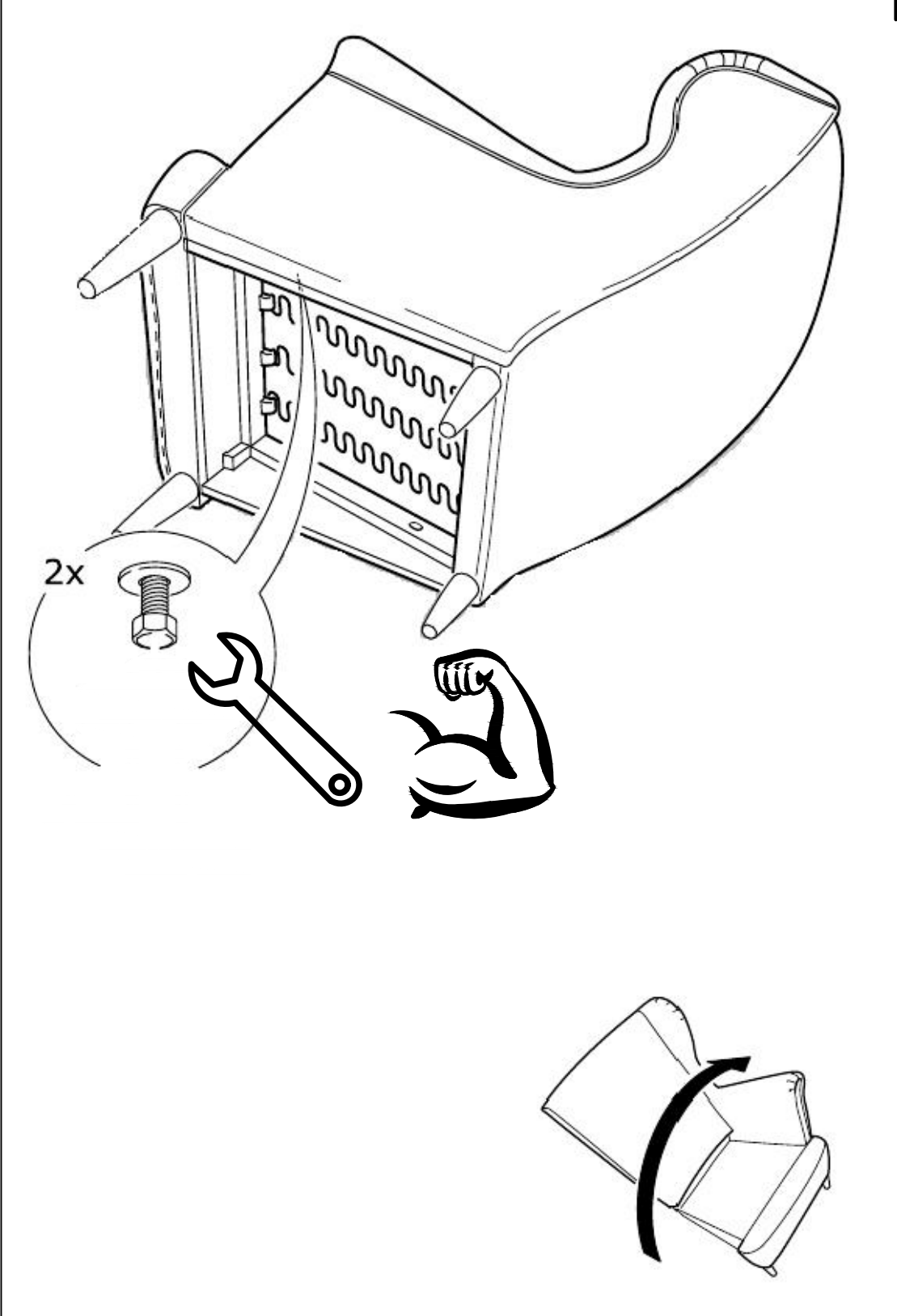

9. Die zweite Seitenwand ist Analog zu den Punkten 6–9 zu montieren.

10.

