

# Servicekarte / Service card

Modelname / Model name

**WZ-0625**

Couchtisch I, Wildeiche massiv geölt/  
Couchtisch I, solid wild oak, oiled

Modellnummer / Model No.

**1005400**

Ausführung / Design

**Eiche / oak**

**71107**

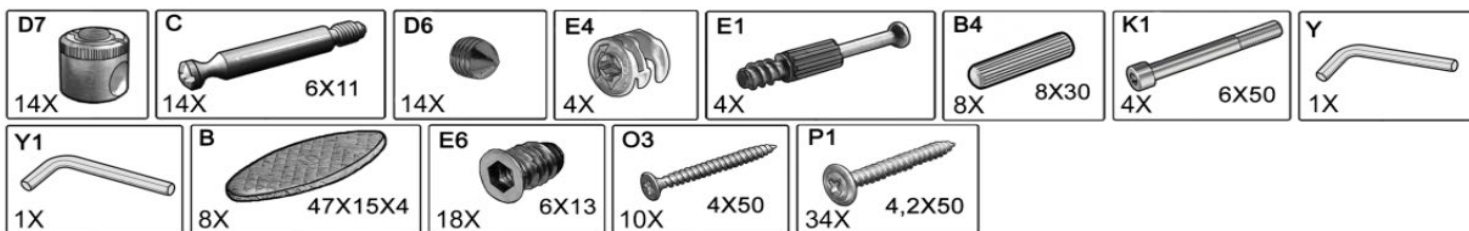
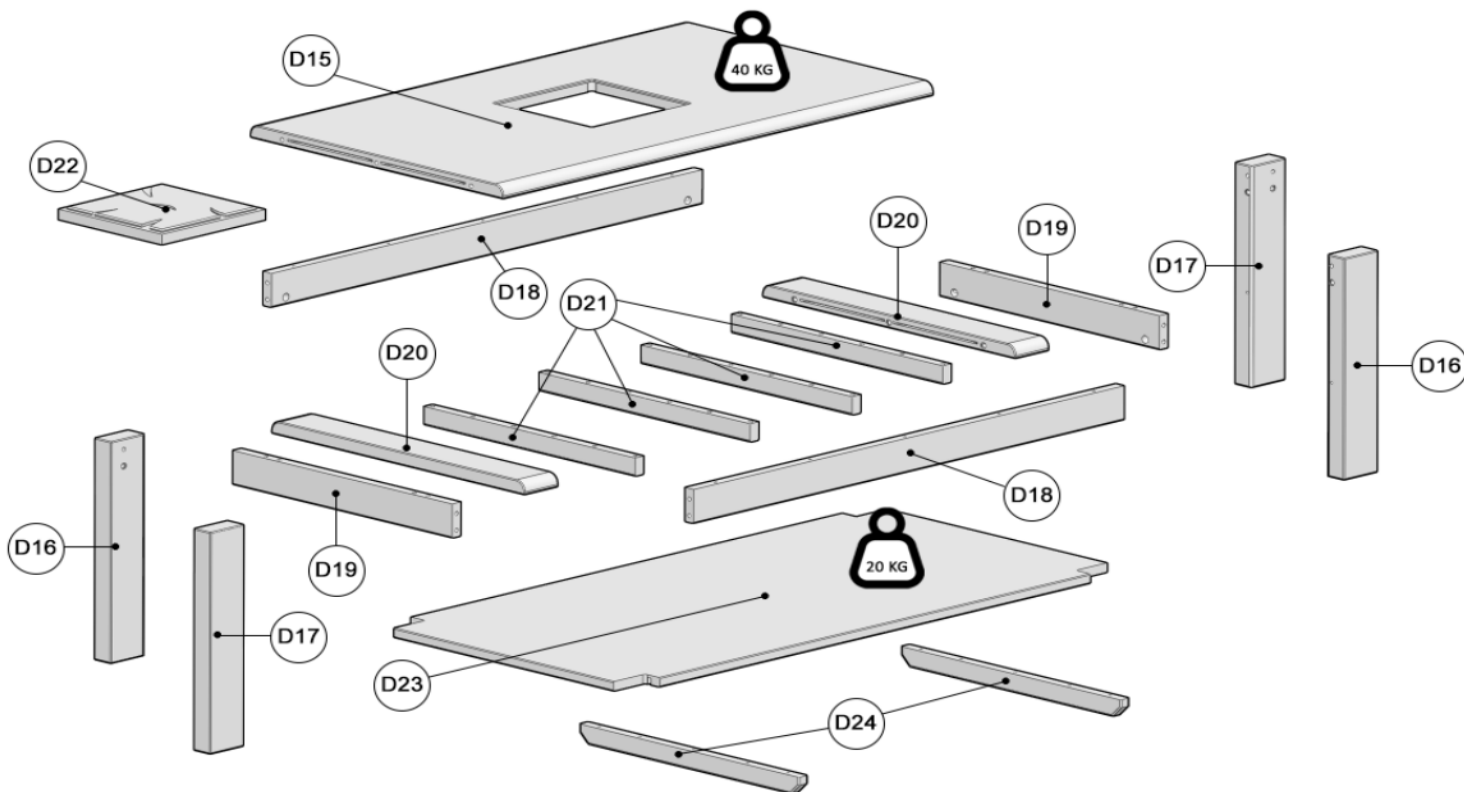

**Grund der Beanstandung:**

reason for complaint:

**Name:**

name:

**Strasse:**

street:

**Postleitzahl:**

postal code:

**Telefonnummer:**

telephone number:

**Ort:**

place:

**HausNr.:**

house number:

**DE:** Sehr geehrter Kunde, Sehr geehrte Kundin!

Fehlt Ihnen ein **Beschlagteil** oder ist es Defekt? Kein Problem! Nutzen Sie unsere Servicekarte!

Unser Direkt-Bestellservice für fehlende/defekte Beschlagteile:

Kontaktieren Sie uns telefonisch unter Tel. **+499503/5033-114** oder senden Sie uns eine E-Mail an [kundendienst@3s-frankenmoebel.de](mailto:kundendienst@3s-frankenmoebel.de). Bitte geben Sie dabei folgende Pflicht-Informationen an: -> Auftragsnummer, Artikelnummer, Nummer des Beschlagteils, fehlende/defekte Menge, und den Grund der Beanstandung, ob es sich um ein defektes oder fehlendes Beschlagteil handelt. Tragen Sie die benötigte Menge ein. Mailen Sie uns die vollständig ausgefüllte Servicekarte zu, um die Bearbeitung zu ermöglichen. Für **andere** Beanstandungen / Beschädigungen an Ihrem Möbelstück wenden Sie sich bitte **direkt an Ihr Möbelhaus**.

**EN:** Dear customer!

Are you missing a **fitting part** or is it defective? No problem! Use our service card!

Our direct ordering service for missing/defective fitting parts:

Contact us by telephone on **+499503/5033-114** or send us an e-mail to [kundendienst@3s-frankenmoebel.de](mailto:kundendienst@3s-frankenmoebel.de).

Please include the following mandatory information: -> Order number, article number, number of the fitting part, missing/defective quantity, and the reason for the complaint, whether it is a defective or missing fitting part. Enter the required quantity.

Mail us the completed service card to enable processing.

For **other** complaints/damage to your furniture, please **contact your furniture store directly**.

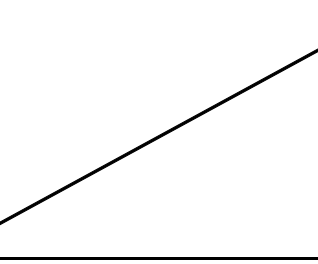
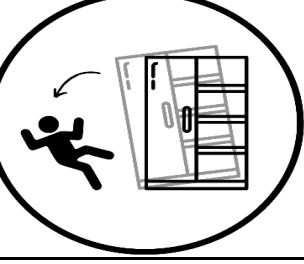
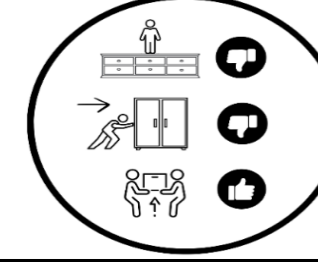
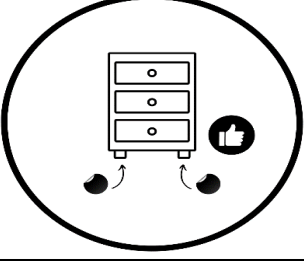
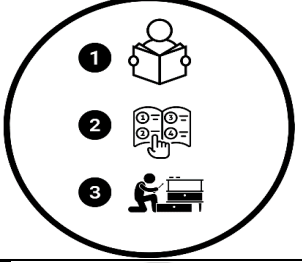
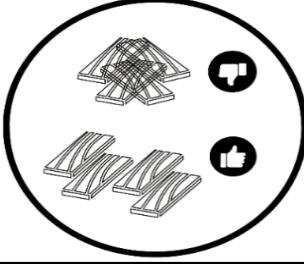
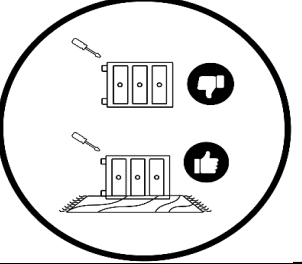
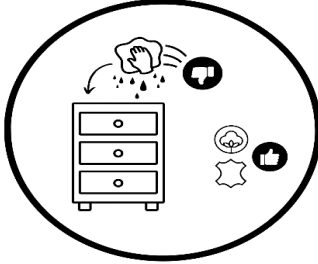
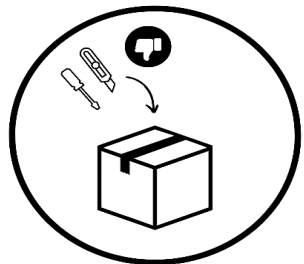
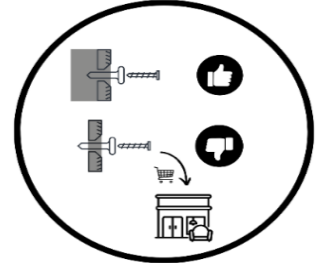
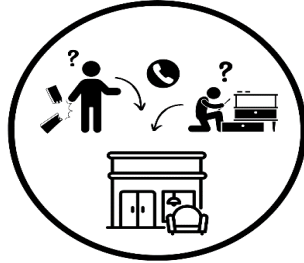

# Couhtisch I

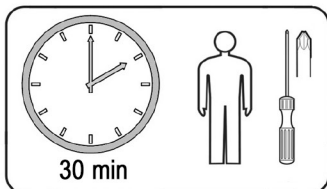
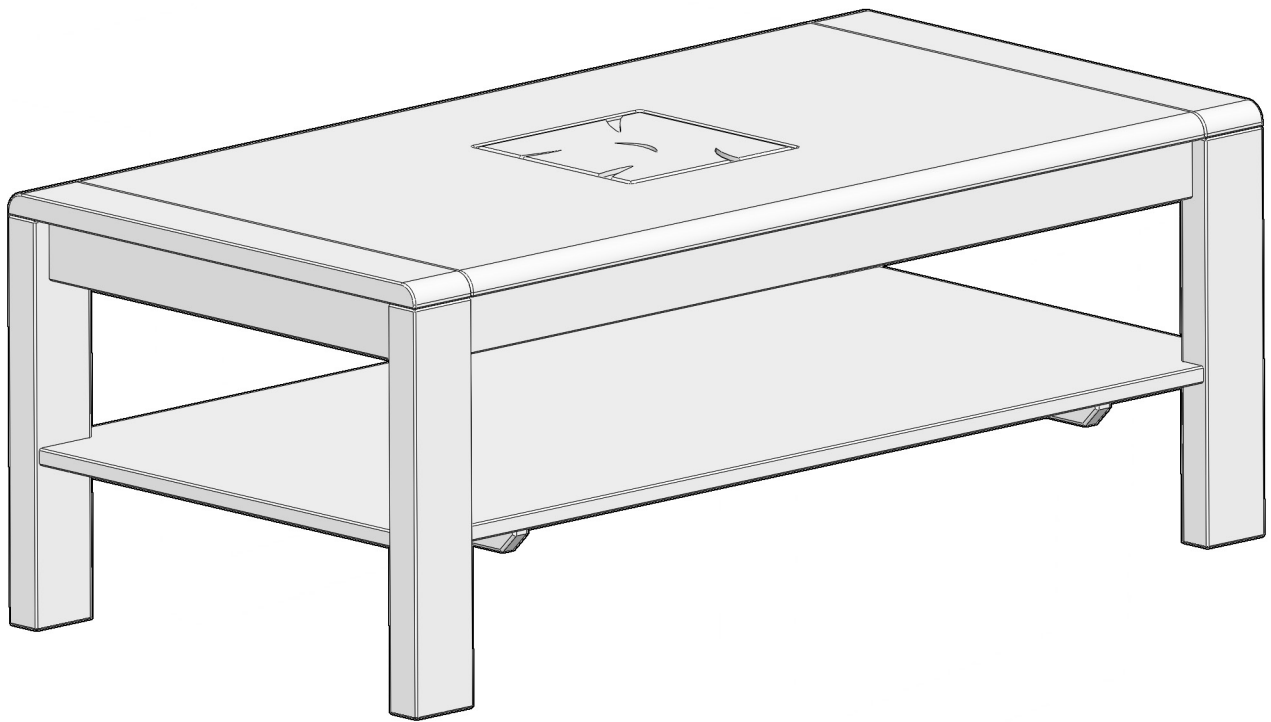

**1180x600x450**

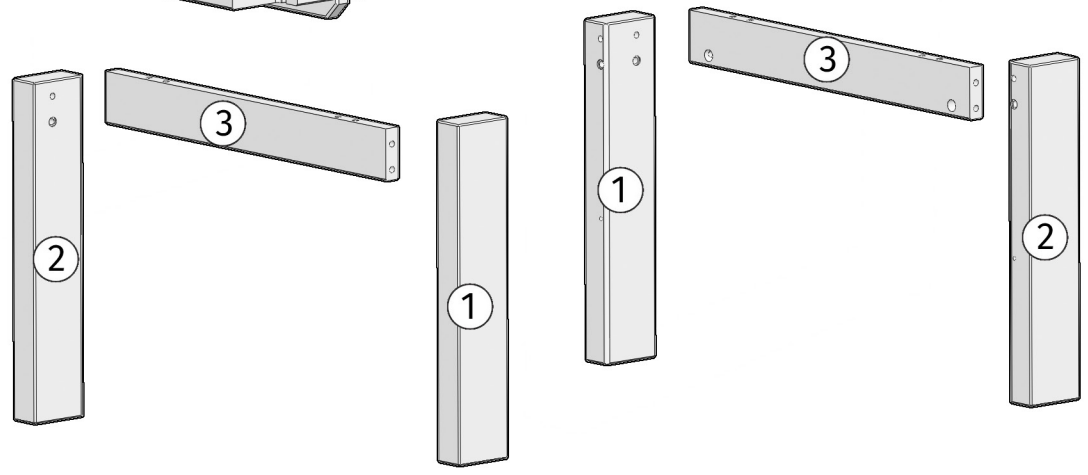
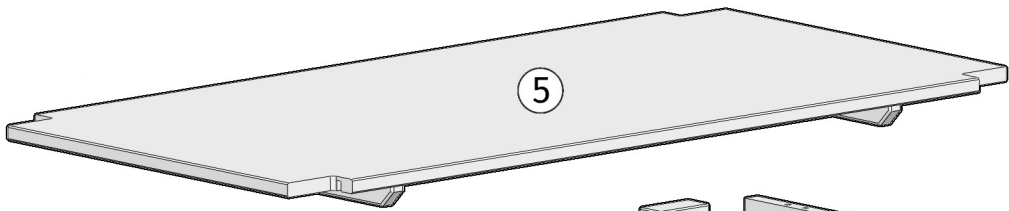
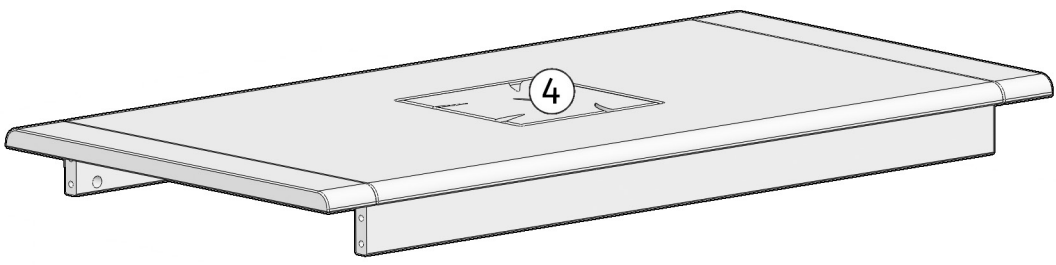
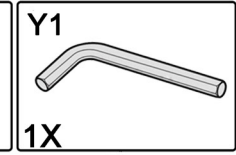
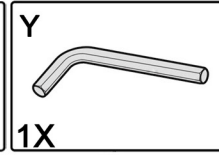
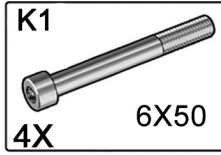
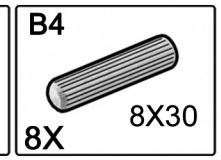
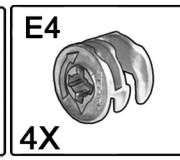
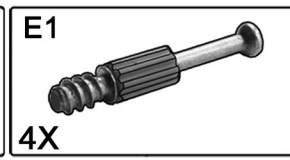
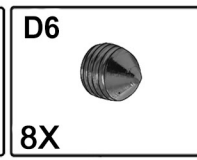
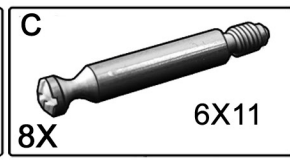
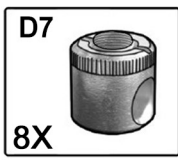

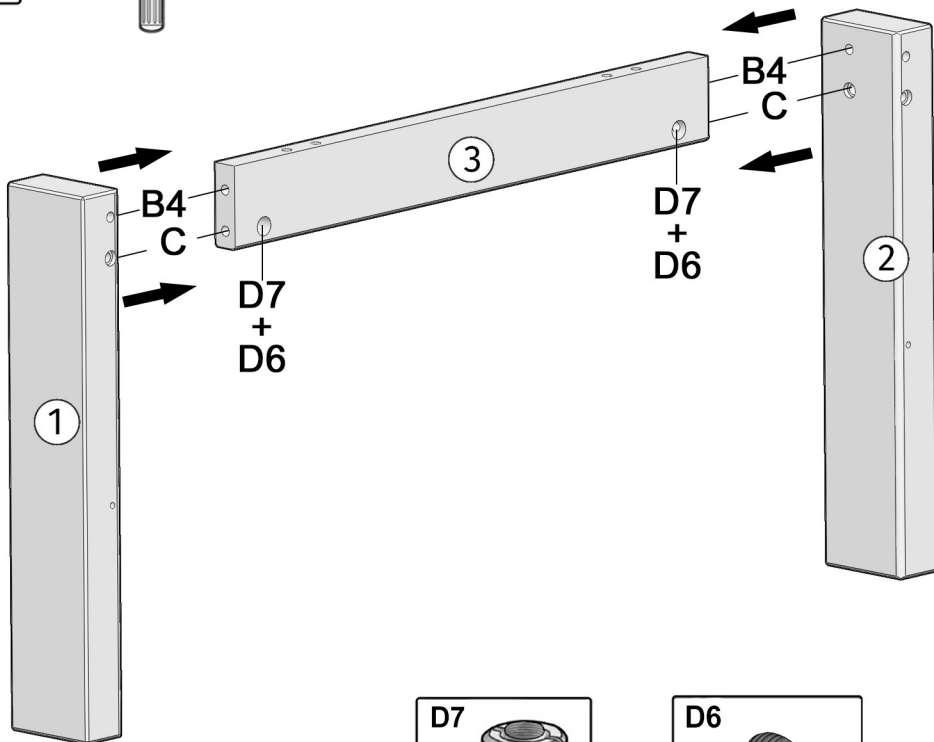
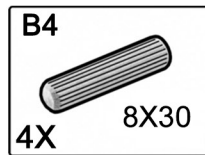
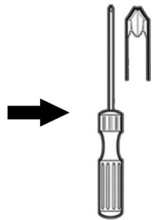
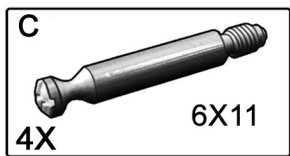

2X

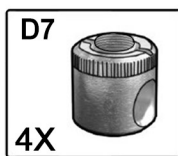

+

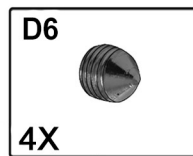

→

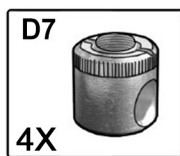
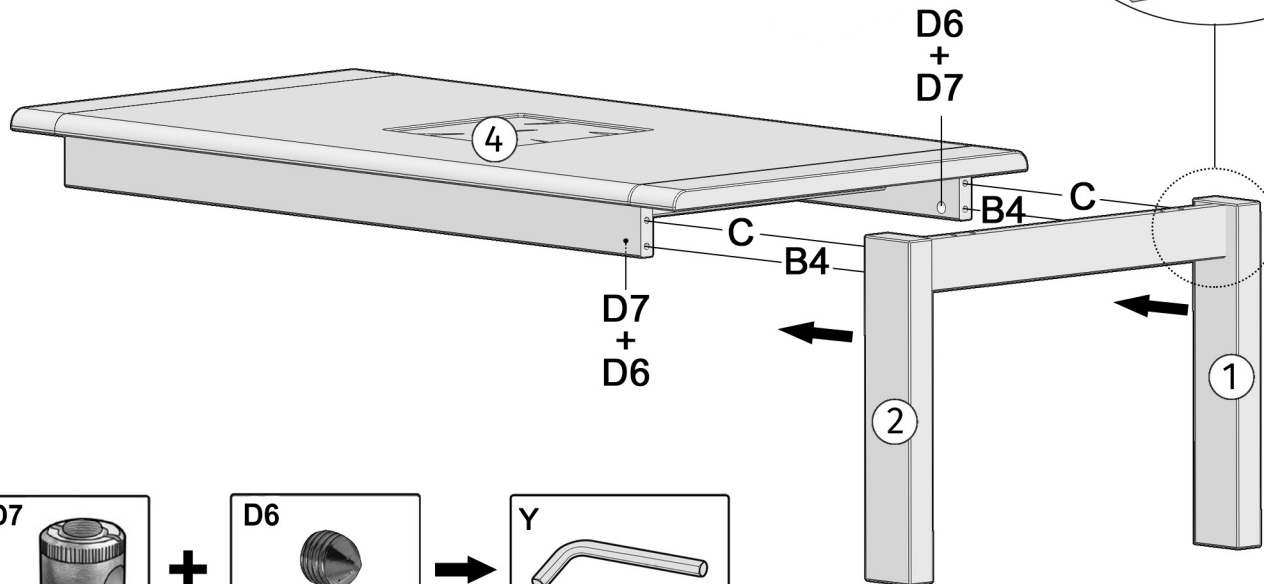
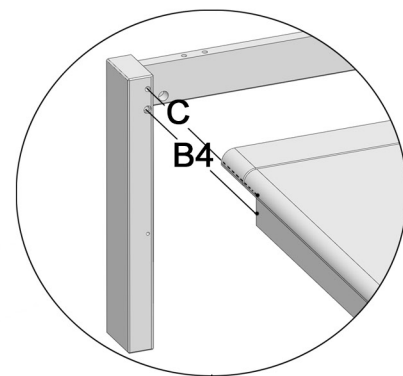
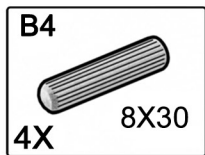
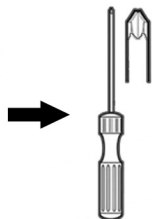
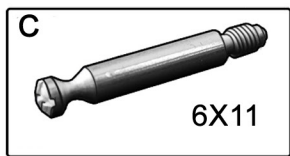
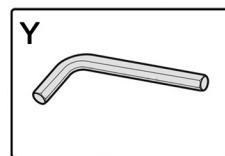

+

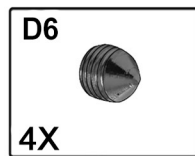

→

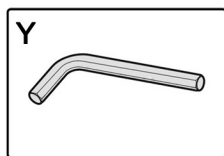

2X

