













ACCESSORIES		
	Included	✓
2x	Not included	
	Included	✓
2x	Not included	
	Included	
	Not included	✗

Aus / OFF  

dim +  

dim-  

Farbwechsel / CCT  

Ein / ON + koppeln / connect  
 Farbtemperatur + / CCT +  
 Farbtemperatur - / CCT -  
 Nachtlcht / Nightlight

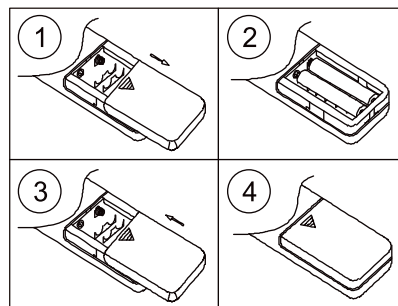

Zum Koppeln der Fernbedienung die EIN-Taste für 3 Sekunden gedrückt halten  
 to connect the remote, push button ON for 3 seconds



DE: Lichtquelle nicht austauschbar  
 CZ: Žárovku nelze vyměnit  
 SE: Ljuskällan är inte utbytbar  
 SK: Nevymeniteľný svetelný zdroj  
 SI: Svetlobnega vira ni mogoče zamenjati  
 HU: A izzó nem cserélhető  
 HR: Izvor svjetlosti nije zamjenjiv  
 BG: Светлинният източник не се сменя  
 RO: Sursa de lumină nu se poate înlocui  
 SR: Izvor svetla se ne može menjati  
 FR: Ampoule non remplaçable



DE: Dieses Produkt enthält eine Lichtquelle der Energieeffizienzklasse: E.  
 CZ: Tento výrobek obsahuje svítidlo třídy energetické účinnosti: E.  
 SE: Denna produkt innehåller en ljuskälla med energiklass: E.  
 SK: Tento výrobok obsahuje svetelný zdroj triedy energetickej účinnosti: E.  
 SI: Ta izdelek vsebuje svetlobni vir razreda energijske učinkovitosti: E.  
 HU: A termék a következő energiaosztályba tartozó fényforrást tartalmaz: E.  
 HR: Ovaj proizvod sadrži jedan izvor svjetlosti razreda energetske učinkovitosti: E.  
 BG: Този продукт съдържа източник на светлина с клас на енергийна ефективност: E.  
 RO: Acest produs conține o sursă de lumină din clasa de eficiență energetică: E.  
 SR: Ovaj proizvod sadrži izvor svetlosti klase energetske efikasnosti: E.  
 FR: Ce produit contient une source lumineuse de classe d'efficacité énergétique: E.

DE: Austausch des Betriebsgeräts durch eine Fachkraft  
 CZ: Výměna ovládacího zařízení odborníkem  
 SE: Byte av manöverdonet av en specialist  
 SK: Výmena ovládacieho zariadenia odborníkom  
 SI: Zamenjava upravljalne naprave s strani strokovnjaka  
 HU: A kezelőeszköz szakember általi cseréje  
 HR: Zamjena upravljačkog uređaja od strane stručnjaka  
 BG: Подмяна на работното устройство от специалист  
 RO: Înlocuirea dispozitivului de operare de către un specialist  
 SR: Zamena operativnog uređaja od strane stručnjaka  
 FR: Remplacement du dispositif de commande par un spécialiste

