

Lewa strona / left side

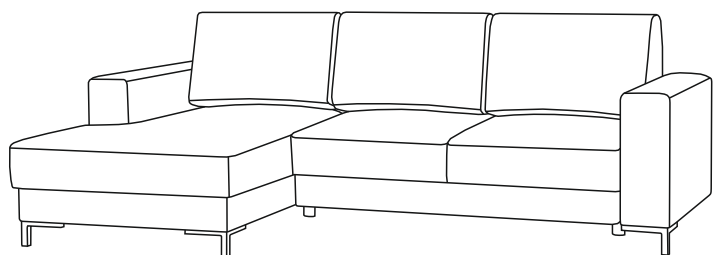

NOTICE DE MONTAGE  
 ASSEMBLING INSTRUCTIONS  
 ISTRUZIONI DI MONTAGGIO  
 MONTAGEANTEILUNG  
 ISTRUÇÕES DE MONTAGEM  
 MANUAL DE MONTAJE  
 SASTAVLJANJE UPUTE  
 INSTRUKCJA MONTAŻU

**HARVEY**

Prawa strona / right side

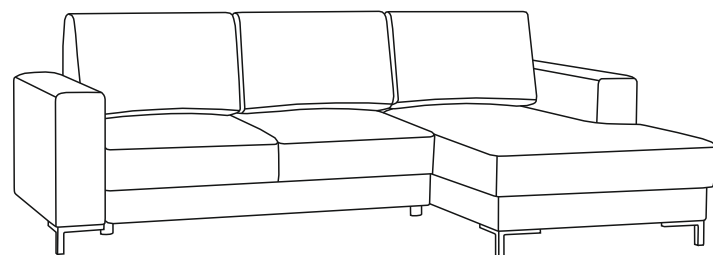

**2020/03/12**



<b>A</b>  x 3	<b>B</b> 10cm  x 3	 C Ø 3,5x35mm x 6	 D Ø 3,5x70mm x 3	 E Ø 8 x 2	 F Ø 8x50mm x 2	 G Ø 10mm x 2	 H 10cm x 6	 I Ø 4x12mm x 12	 J Ø 4,5x25mm x 9
---------------------	-----------------------------	----------------------------	----------------------------	---------------------	--------------------------	------------------------	----------------------	---------------------------	----------------------------

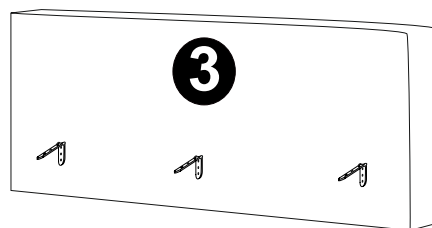
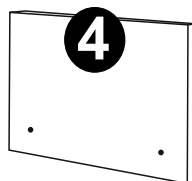
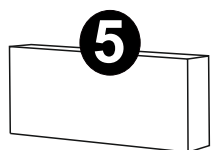
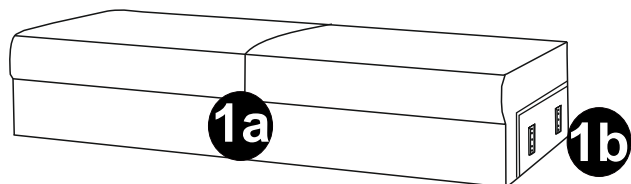
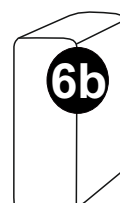
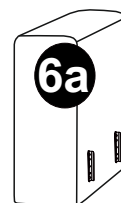
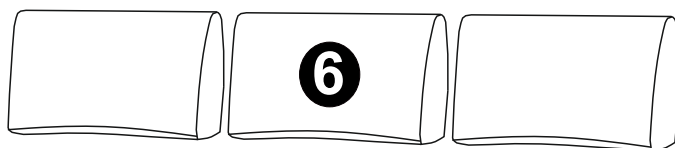

AVANT DE COMMENCER, SE  
 REPORTER AUX CONSEILS  
 DE MONTAGE EN ANNEXE

BEFORE STARTING REFER  
 TO THE ASSEMBLING ADVICE  
 IN ANNEX

AVANTI DI COMMINCIARE  
 RIPORTATE AGLI CONSIGLI DI  
 MONTAGGIO

VOR DIE MONTAGE, BITTE  
 BEILIEGENDE ANWEISUNGEN  
 FOLGEN

ANTES DE COMERCAR, ADIARSE  
 AOS CONSELHOS DE  
 MONTAGEM EM ANEXO

ANTES DE EMPEZAR  
 CONSULTE LOS CONSEJOS  
 PARA EL MONTAJE

PRIJE POČETKA OBRATITE  
 U okupljanje savjet u DODA TKU

PROSZĘ ZAPOZNAĆ SIĘ Z INSTRUKCJĄ  
 PRZED ROZPOCZĘCIEM MONTAŻU

Lewa strona / left side

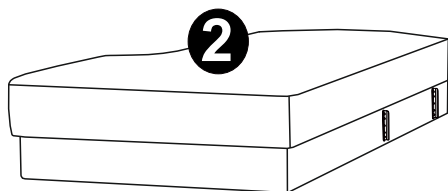

Prawa strona / right side

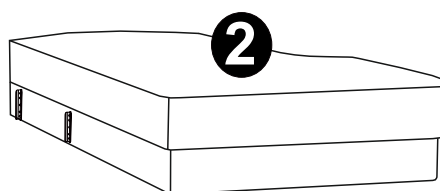

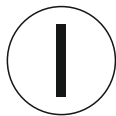

Lewa strona / left side  
Prawa strona / right side

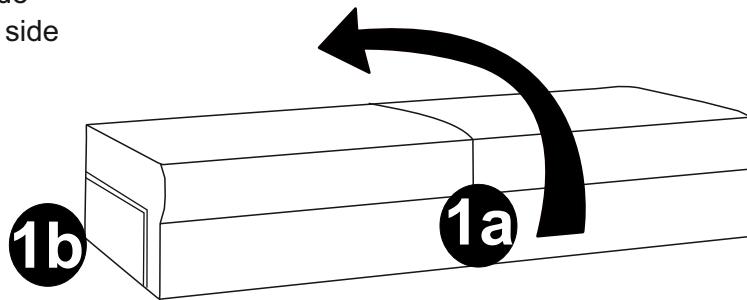

Lewa strona / left side  
Prawa strona / right side

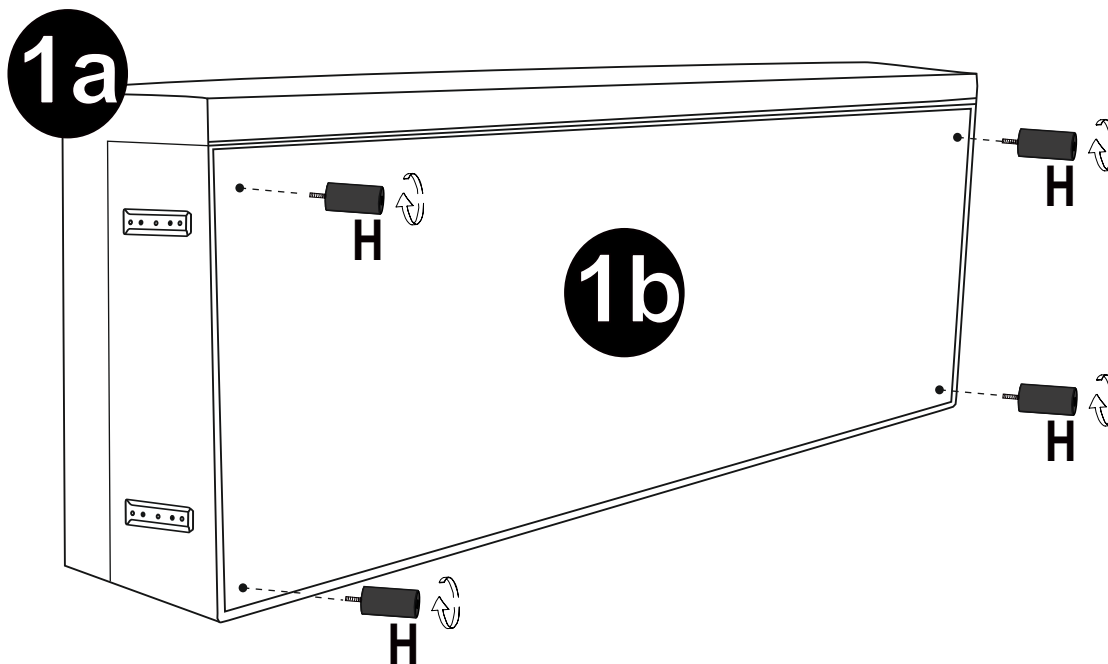
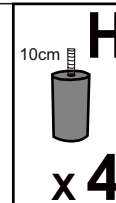

Lewa strona / left side  
Prawa strona / right side

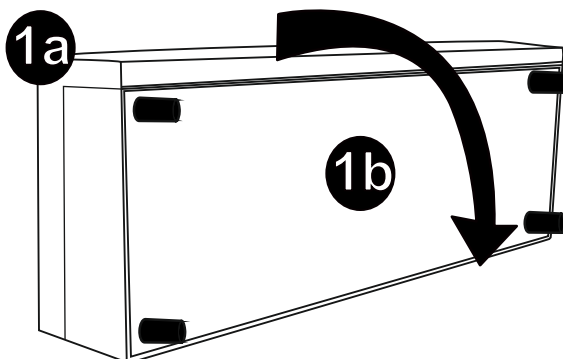

**IV**

Lewa strona / left side  
Prawa strona / right side

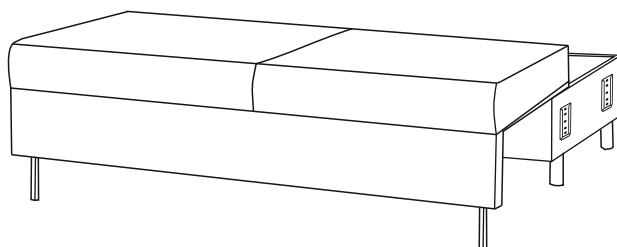
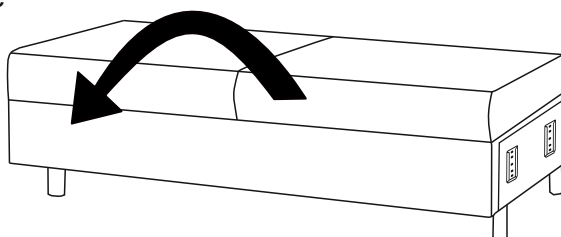

**V**

Lewa strona / left side  
Prawa strona / right side

**C**  
Ø 3,5x35mm  
  
**x 6**

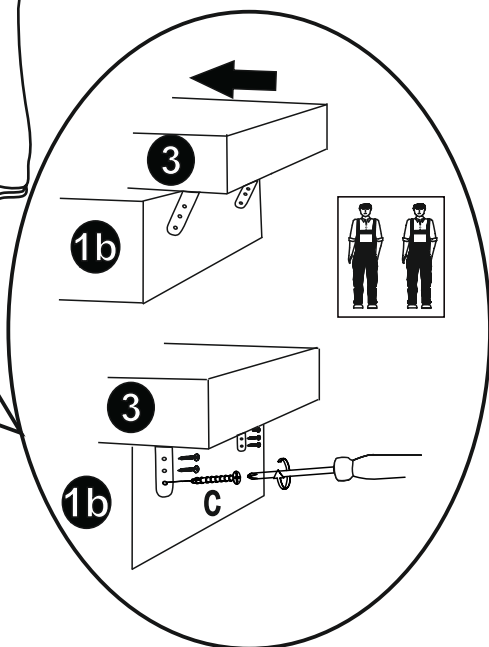
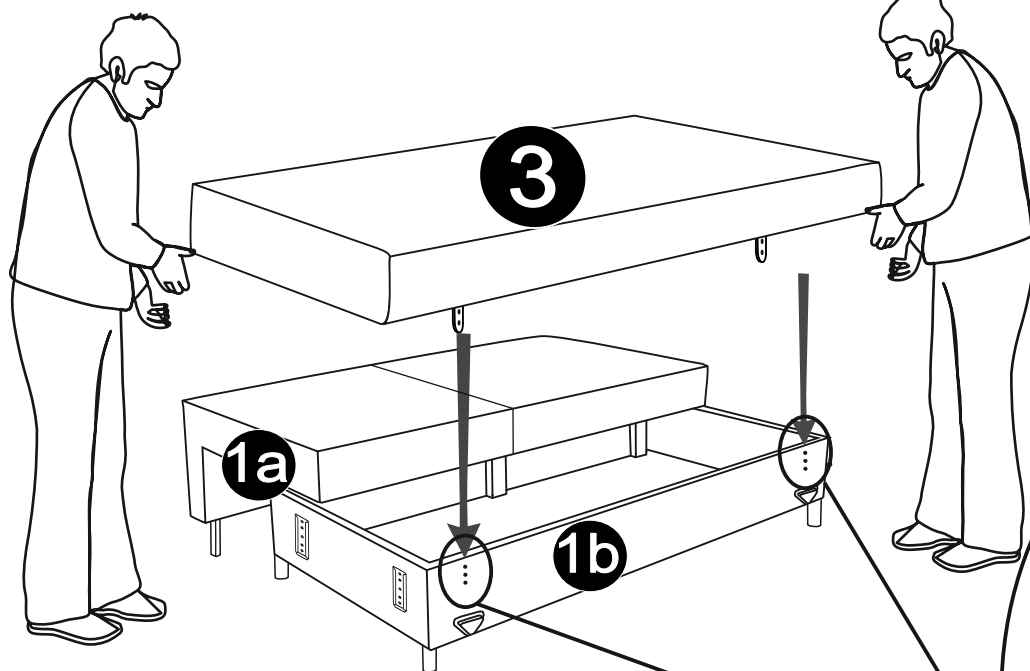
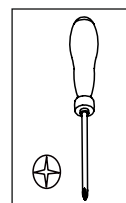

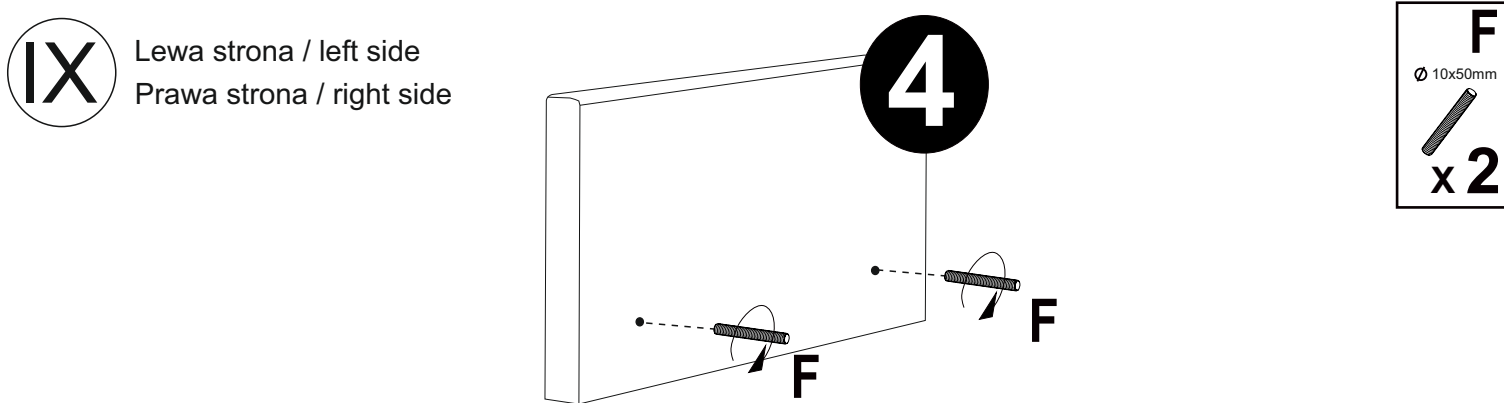
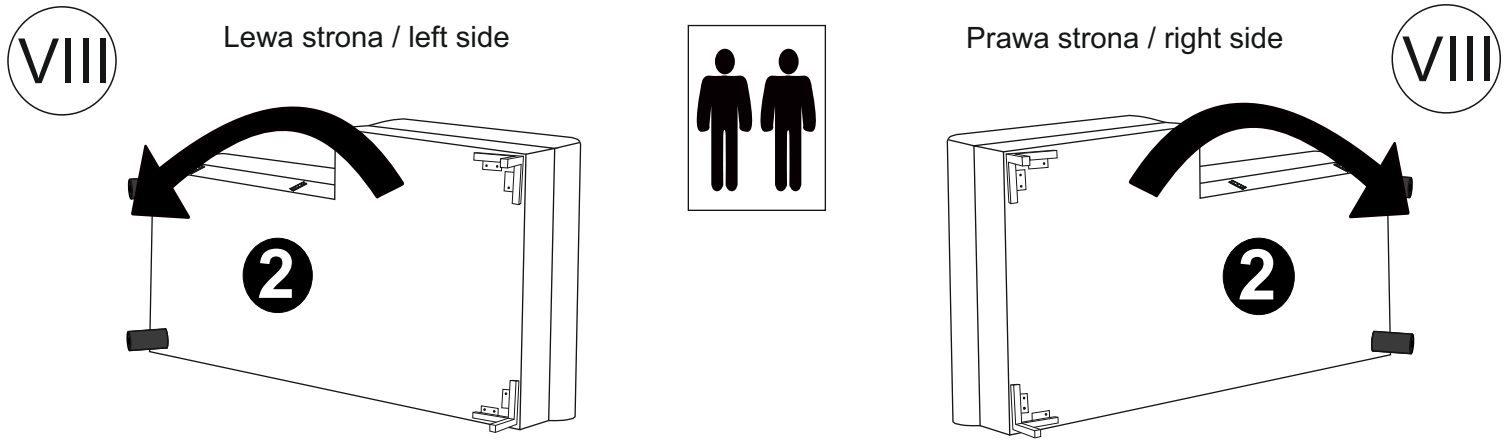
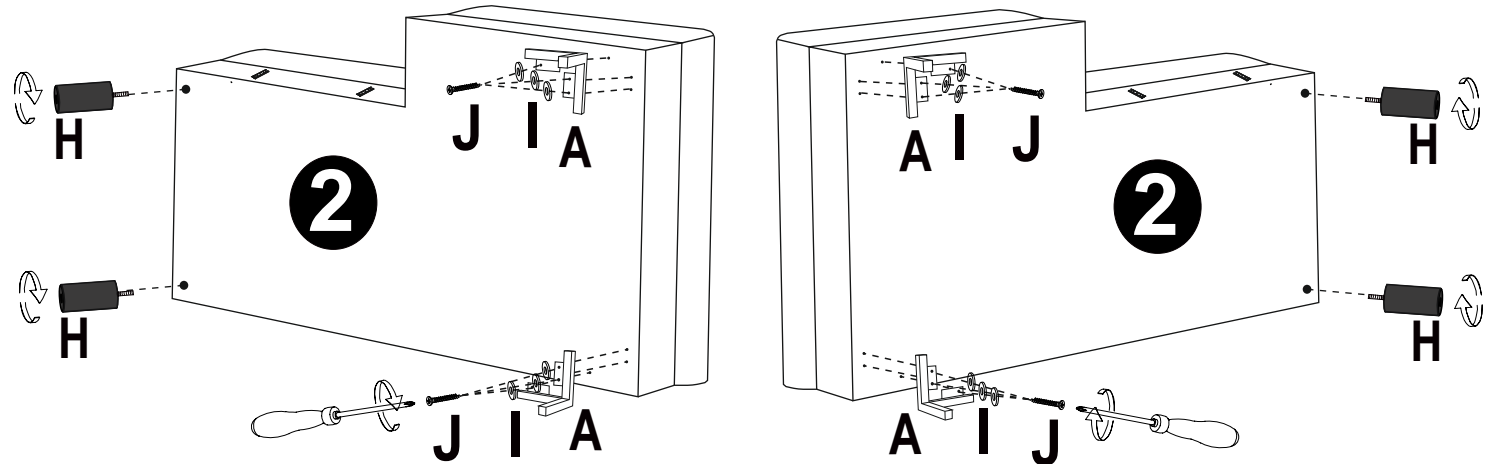
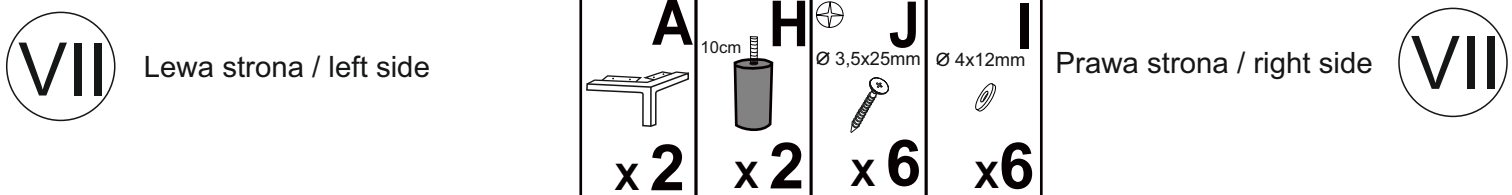
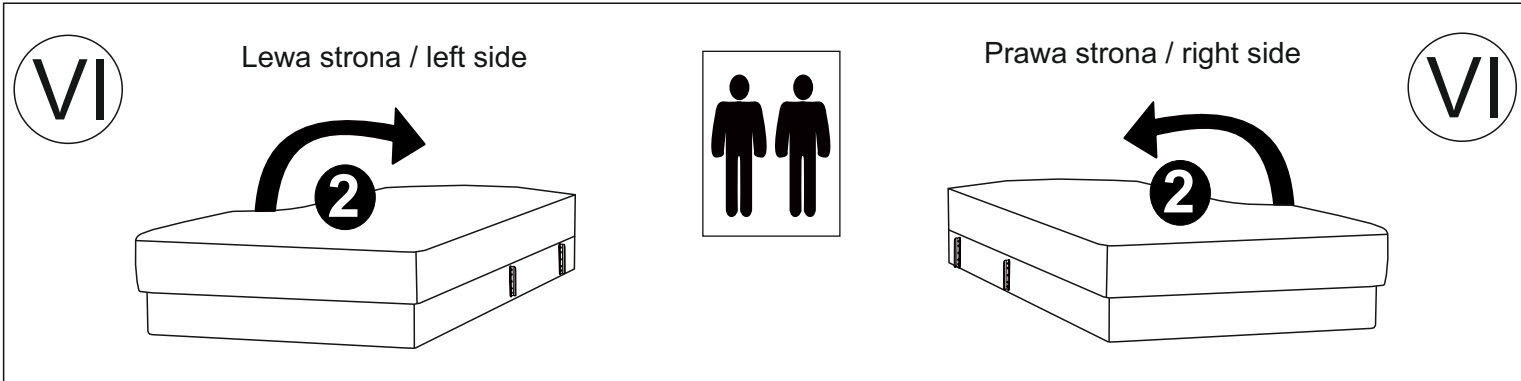



Lewa strona / left side

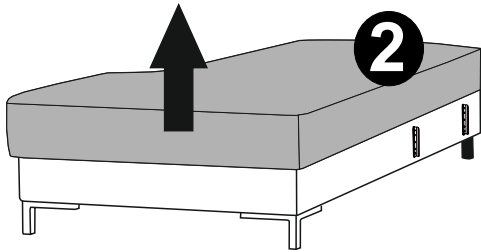

Prawa strona / right side

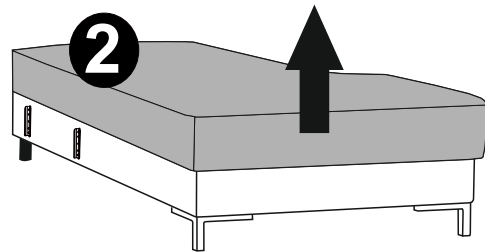

Lewa strona / left side

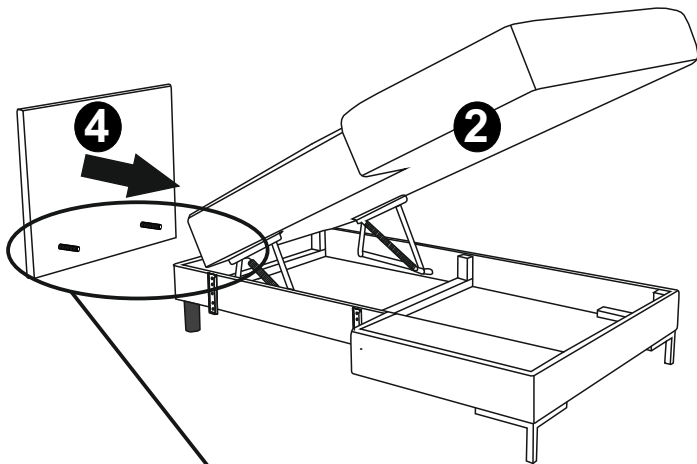

Prawa strona / right side

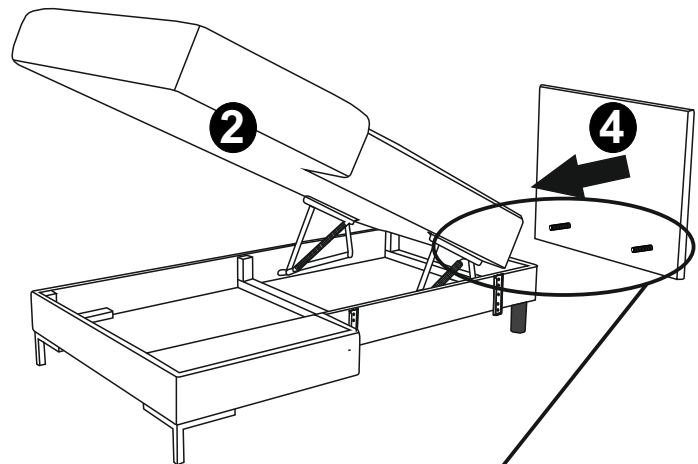

Diagram illustrating the assembly of the headboard (part 2) to the bed frame (part 4). The diagram shows the connection points and the required hardware:

- Part E:  $\varnothing 8\text{mm}$  (x 2)
- Part G:  $\varnothing 8\text{mm}$  (x 2)

The diagram also includes a warning icon showing two people, indicating that two people are required for this step.

**XII**

Lewa strona / left side  
Prawa strona / right side

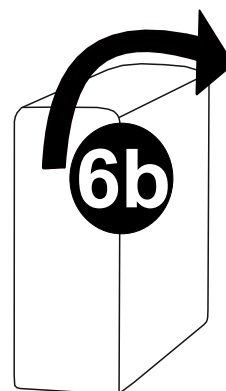
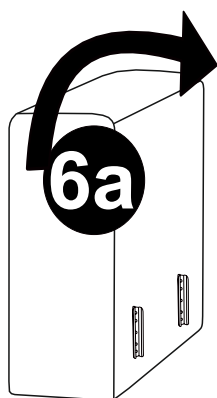

**XIII**

Lewa strona / left side

**6a**

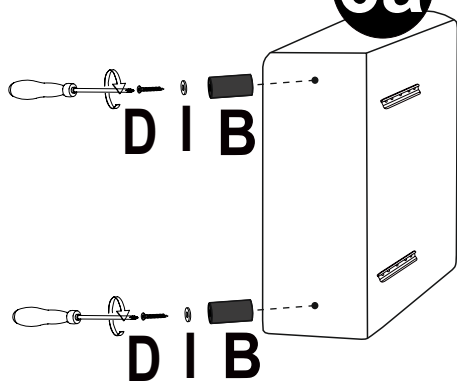

**6b**

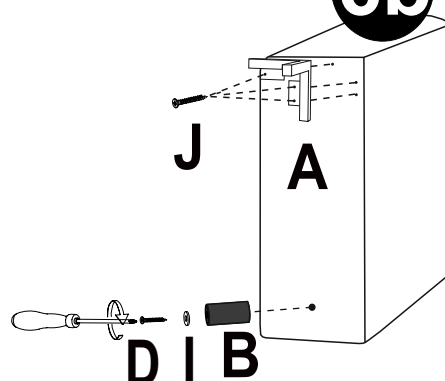

**XIII**



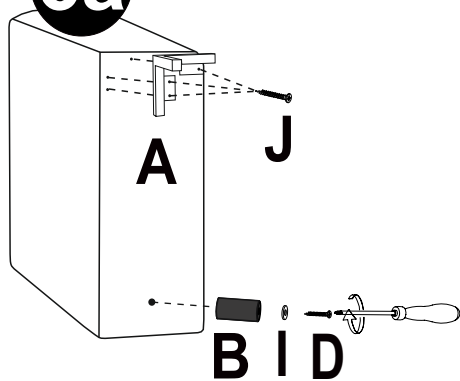

Prawa strona / right side

**6a**

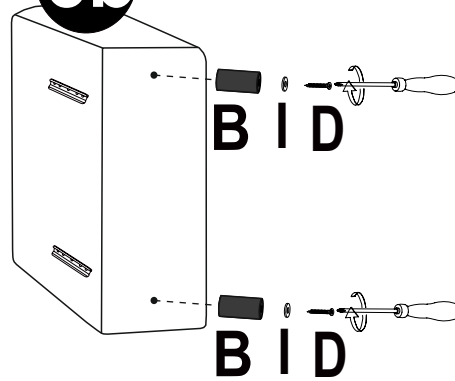

**6b**



<b>A</b>  x 1	<b>B</b> 10cm  x 3	<b>J</b>  Ø 3,5x25mm x 3	<b>D</b>  Ø 3,5x70mm x 3	<b>I</b>  Ø 4x12mm x 6
--	--	--	--	--

**XIV** Lewa strona / left side

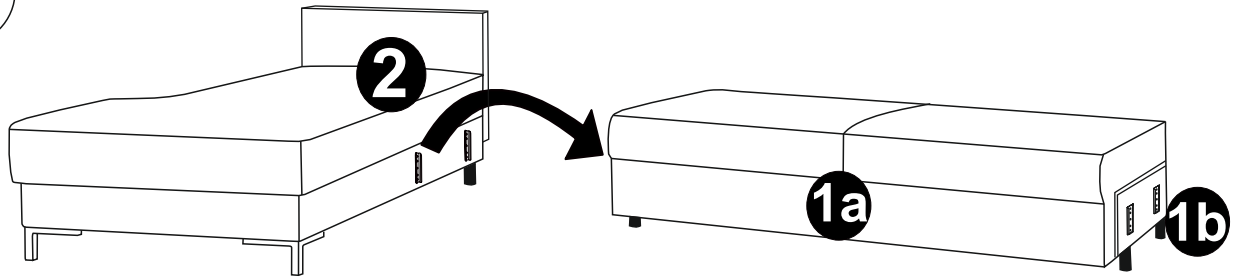

**XIV** Prawa strona / right side

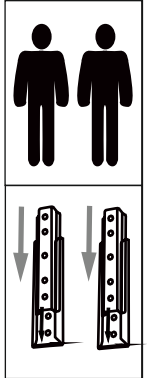
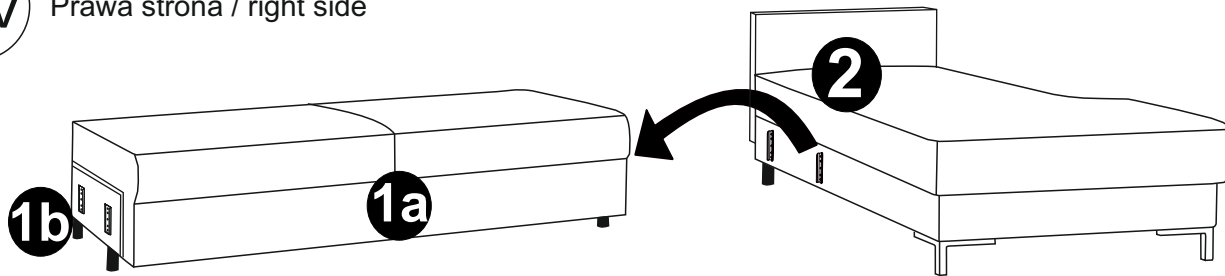

**XV** Lewa strona / left side

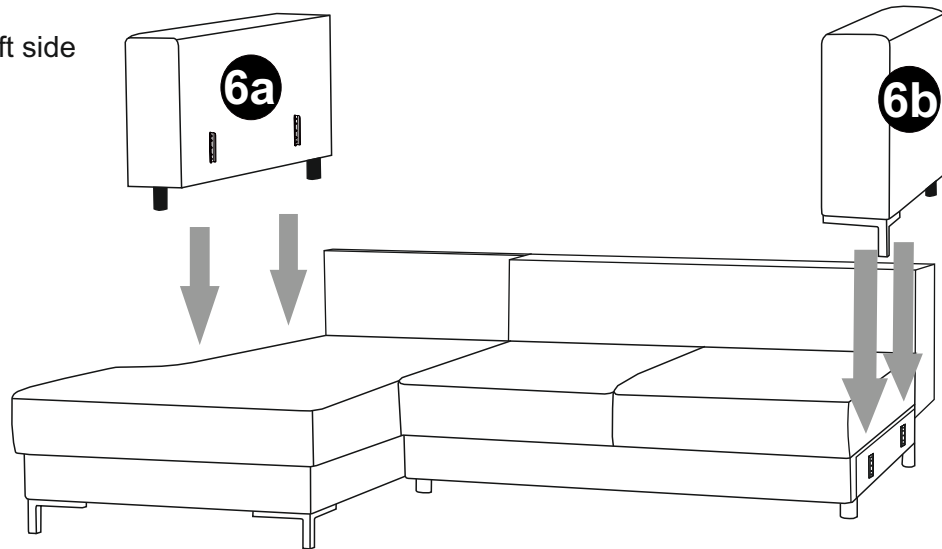

**XV** Prawa strona / right side

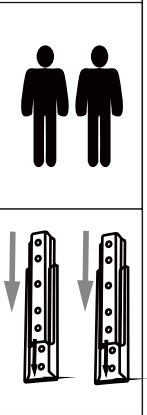
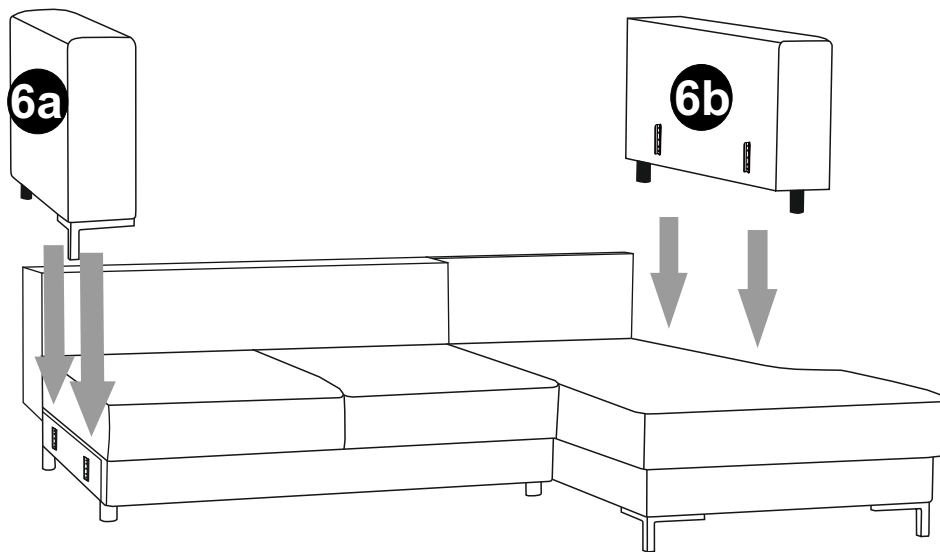

**XVI**

Lewa strona / left side

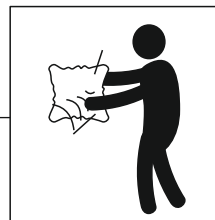
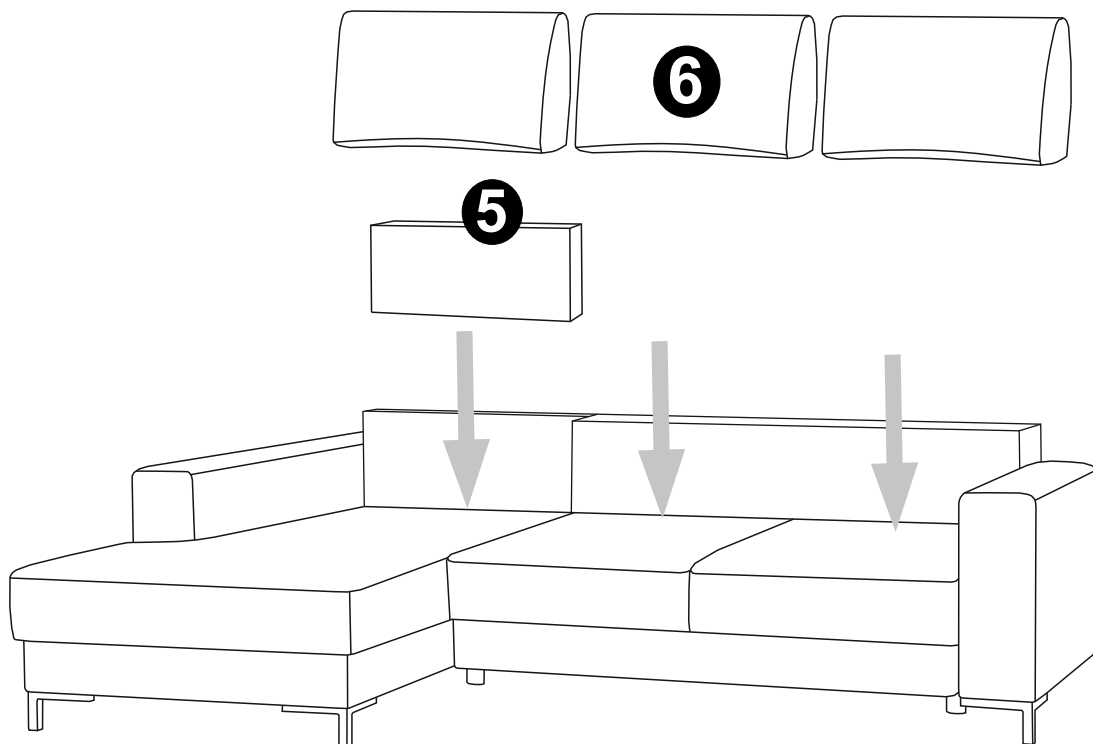

**XVI**

Prawa strona / right side

