

# TIBOR-G

## 10 T3 RM 10

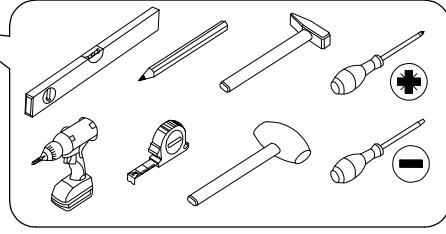
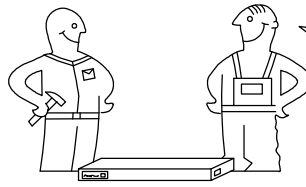

VERSION-L

VERSION-R

#	ART. NR	L	W	T	Q	Col.No
1	2050R	402	380	16	1	1
2	2051R	402	360	16	1	1
3	2052R	1811	360	16	1	2
4	2053R	1811	360	16	1	2
5	2054R	367	330	16	2	1
6	2055R	365	320	5	2	1
7	2056R	463	397	16	1	1
8	2057R	896	80	16	1	1
9	2058R	463	397	16	1	1
10	2059R	956	330	4	1	2
11	2060R	448	382	2,5	1	1
12	2061R	950	382	2,5	1	2
13	2062R	426	382	2,5	1	1

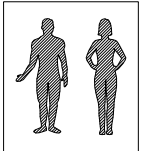
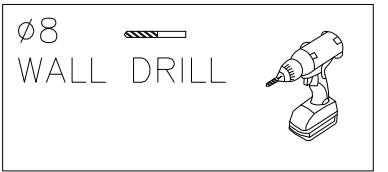
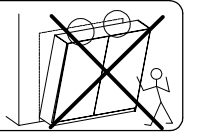
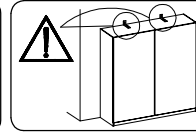
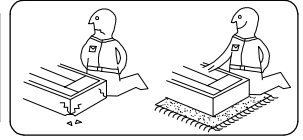
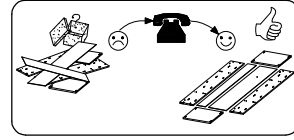
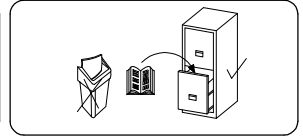
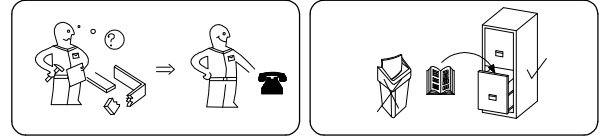
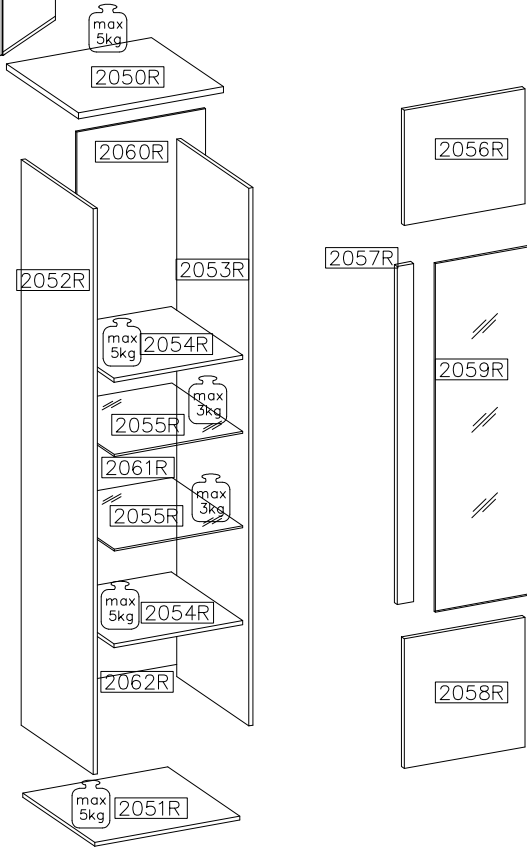
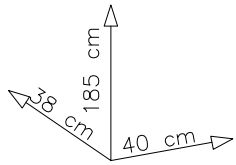
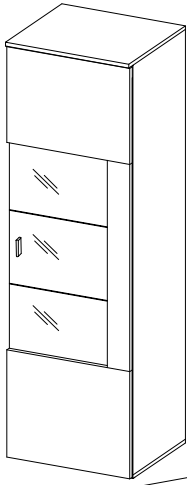
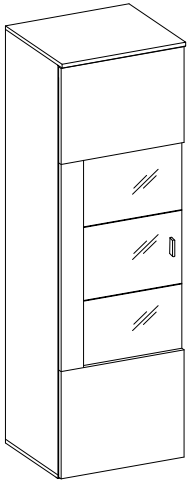

A	A1	B	C	D1	D2	E	E1	J9	R3
16	2	8	12	8	2	12	8	2	2
L	O	P1	P9	J5	K13	V5	S1		
10	1	10	10	8	1L+1R	2	1		
J8	P8	G6	F8	U4	K9				
7	7	5	10	4	2				

1

∅8x30mm



A

8

∅5.0mm



J5

8



D1

8

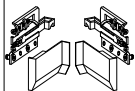

K13

1L+1R

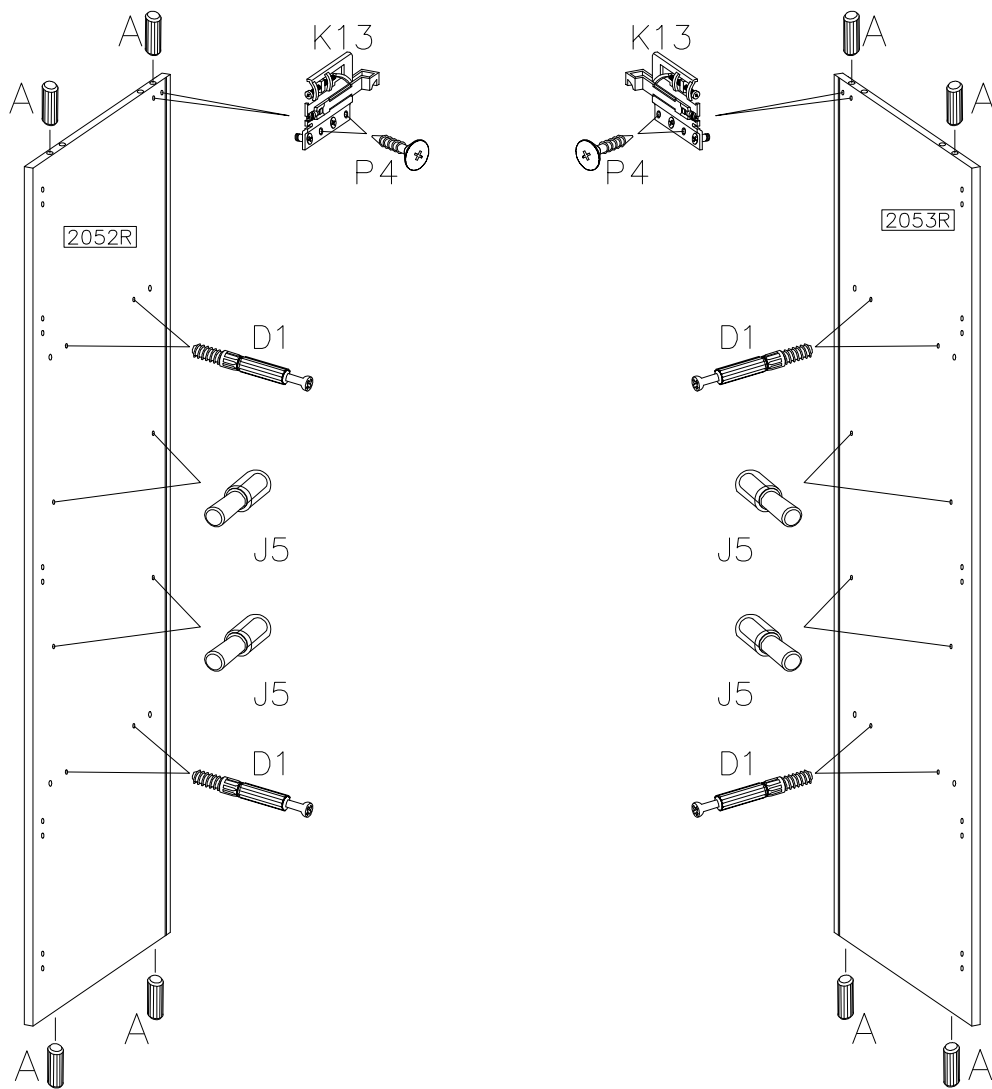
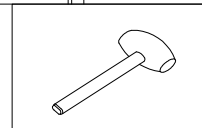
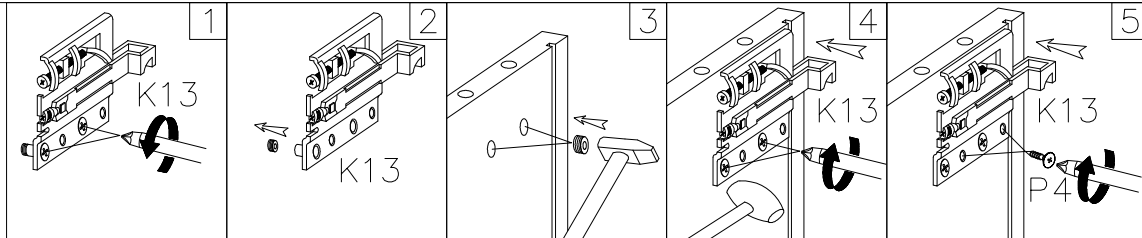

2

∅8x30mm



A

8

∅15/12mm



C

8

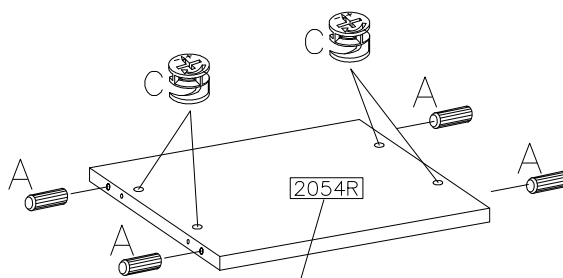

2x

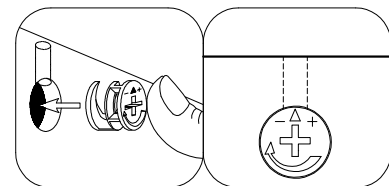

3

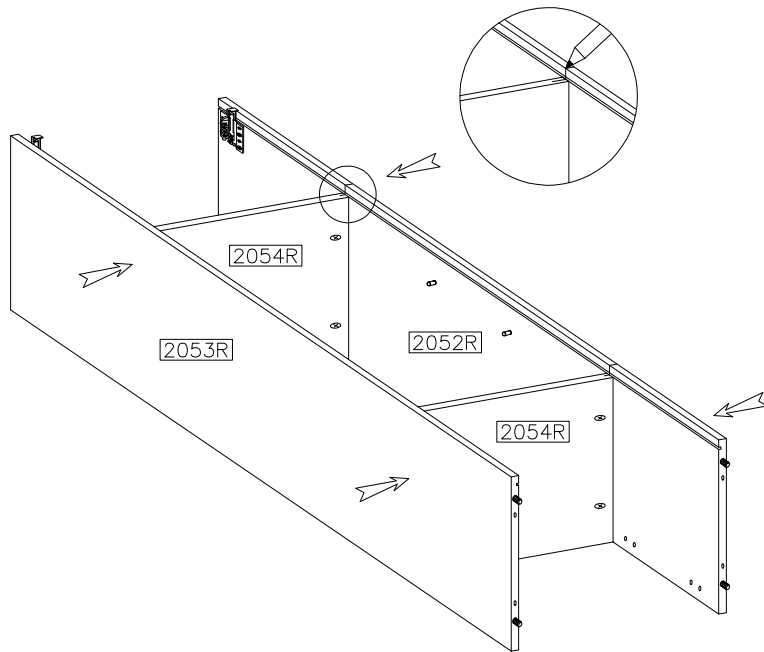
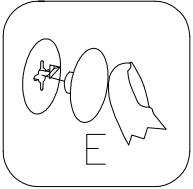
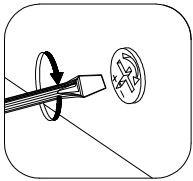
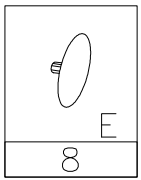

4

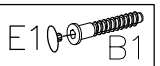
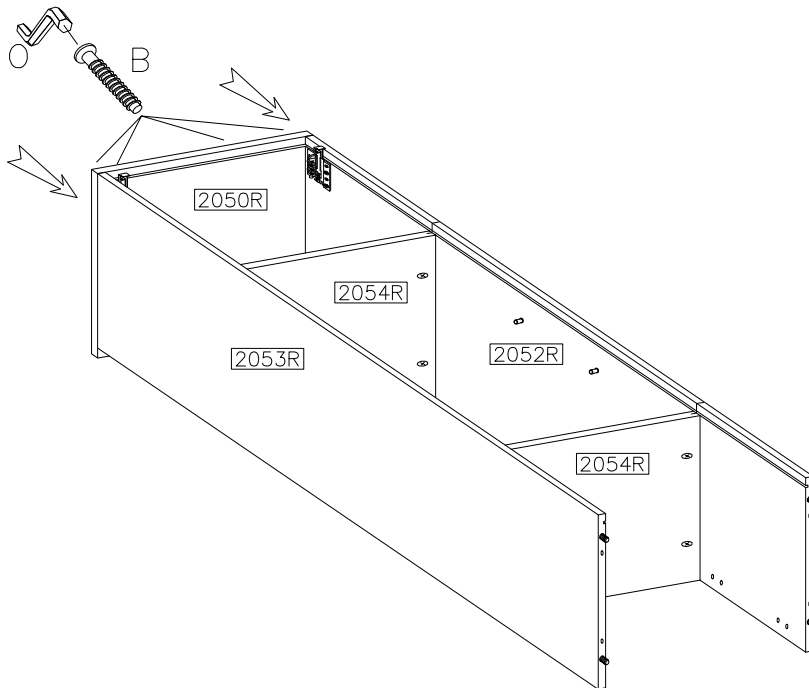

- Ø6,4x50mm  
B
- 4
- E1
- 4
- O
- 1

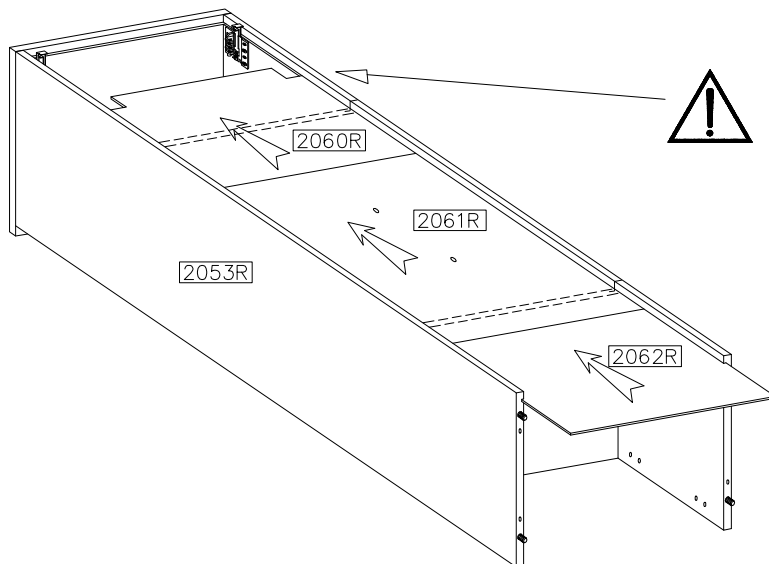

5



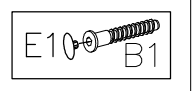
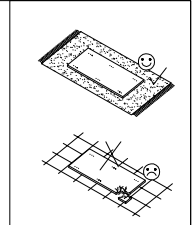
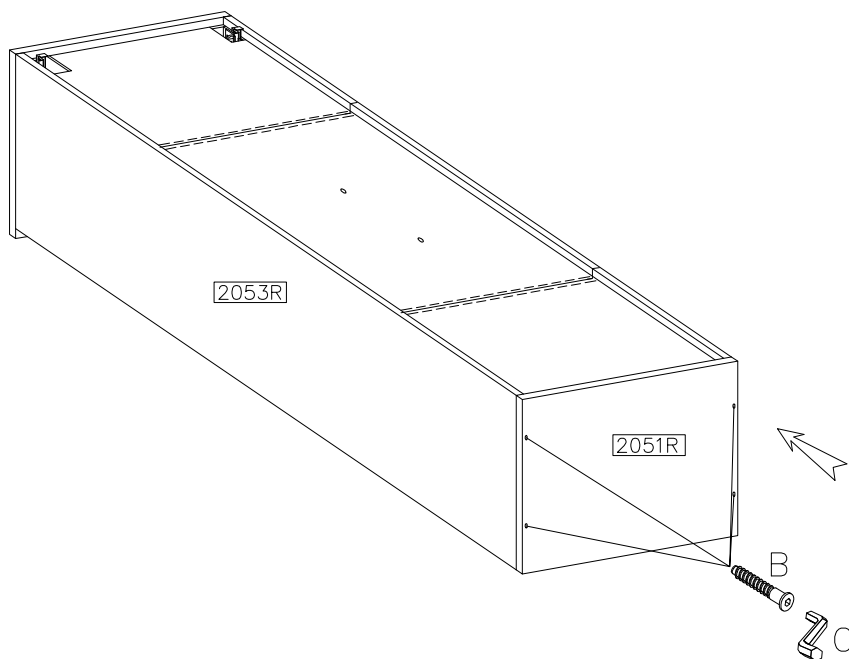

6

 ø6,4x50mm B 4
 E1 4
 O 1



7

 ø3.0x16mm P1 10	 L 10	 F8 10
---	--	---

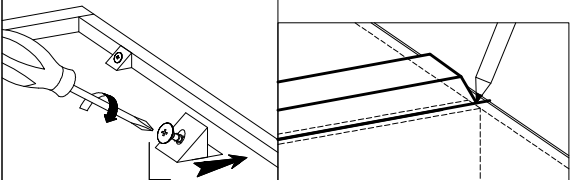
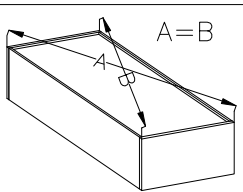
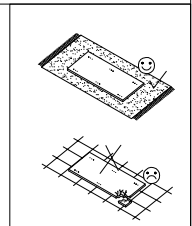
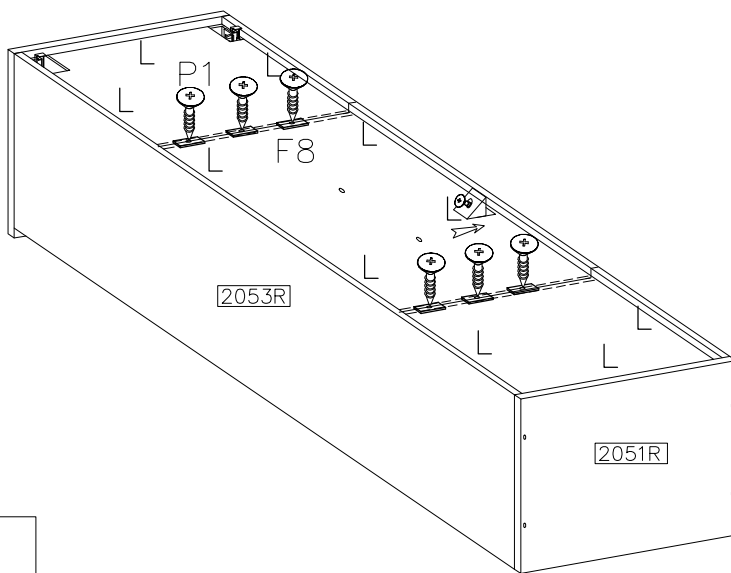

8

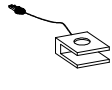
 V5 2
--

KA 270016  
Lisa-GTP10

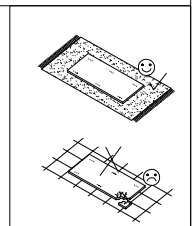
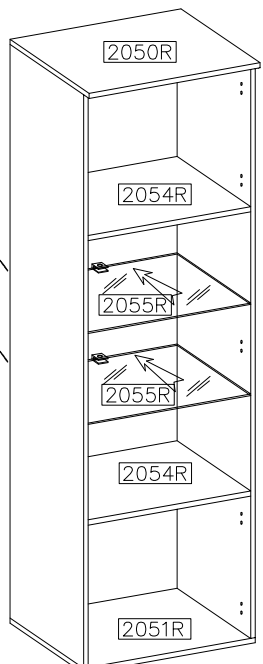
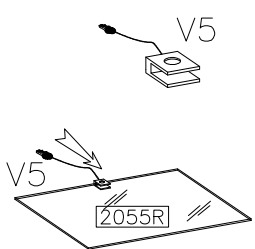

9

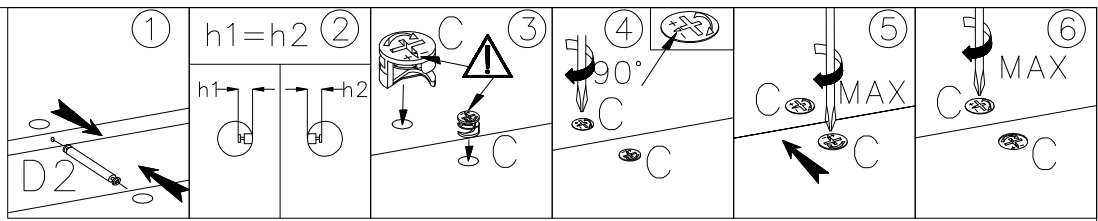

L-46	
2	D2
2	ø8x40mm
A1	
2	A1
2	ø15/12mm
C	
4	C
E	
4	E

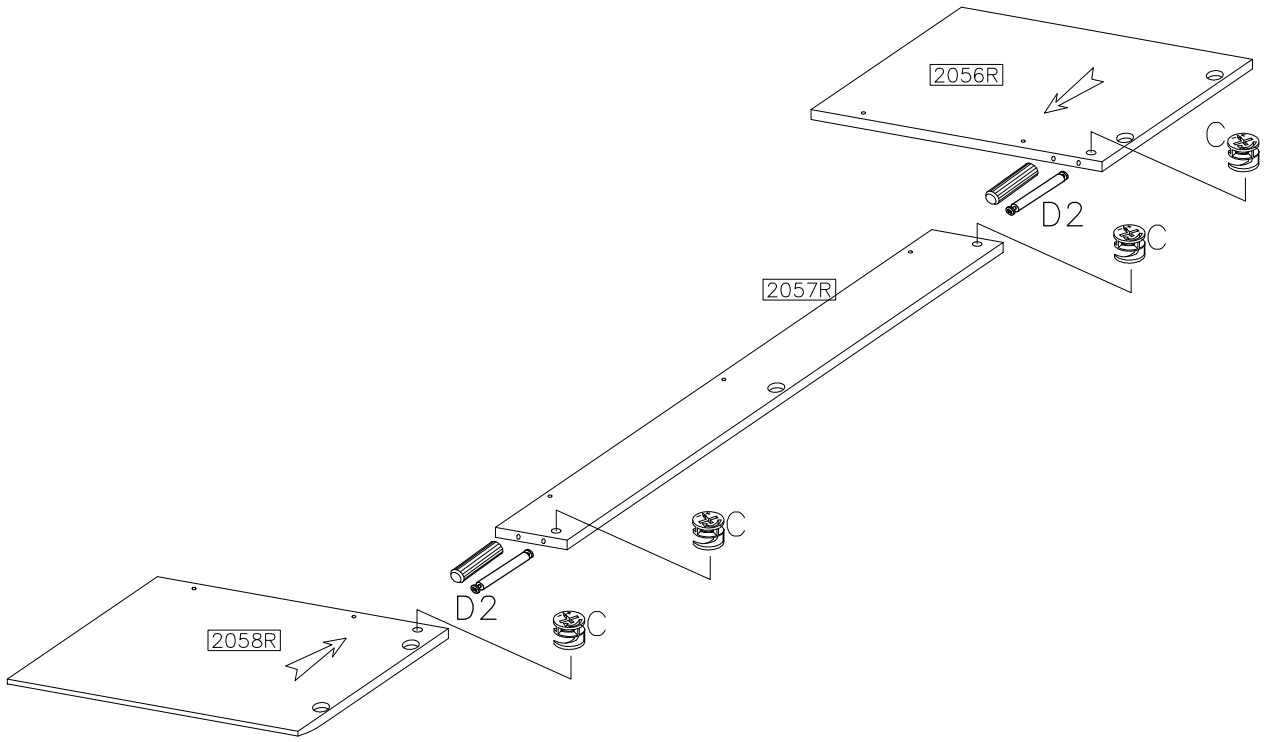

10



ø8	ø4.0x16mm
J8	P8
7	7
ø5.0x13mm	ø35/KR-0
P9	G6
10	5

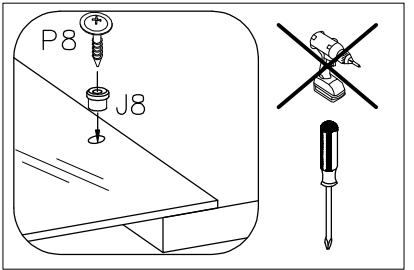
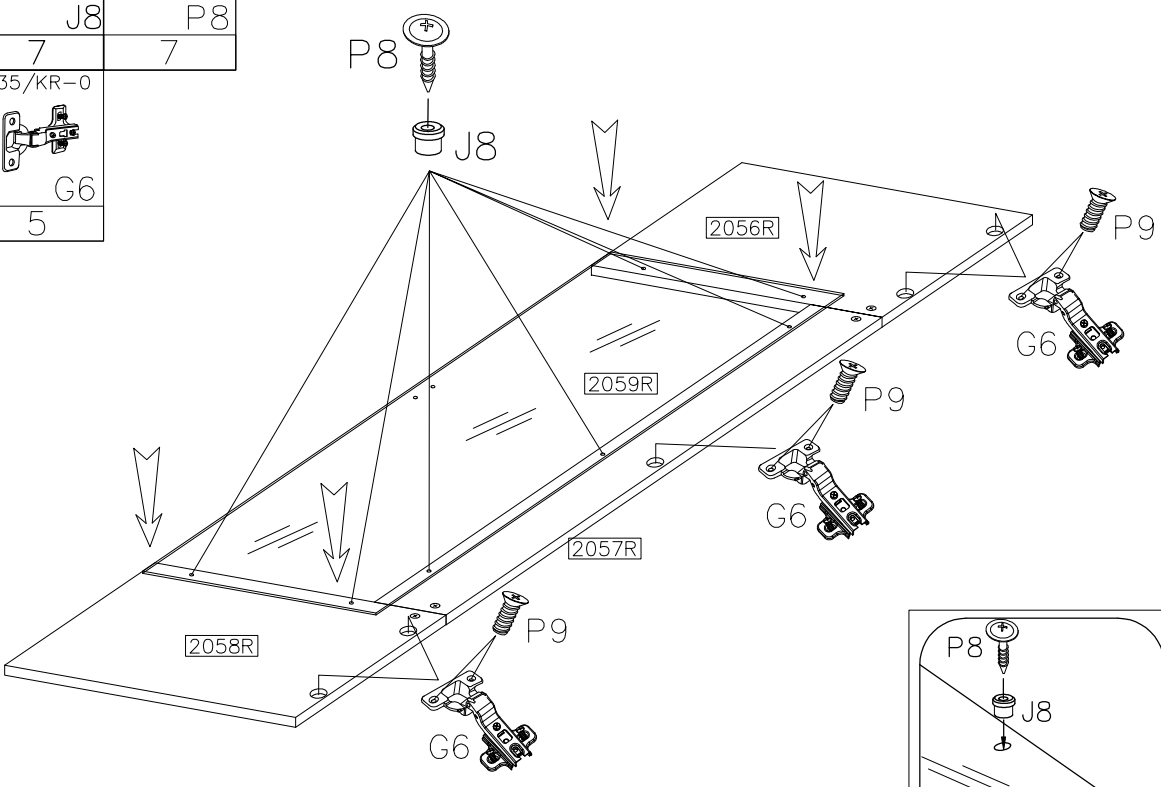

11

	S1
1	
∅6	
	J9
2	
M4.0x12mm	
	R3
2	

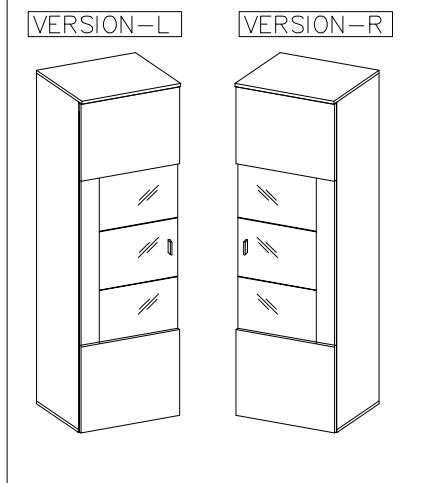
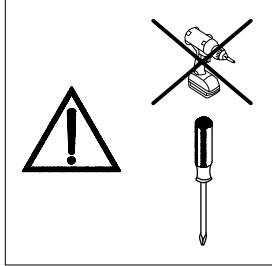
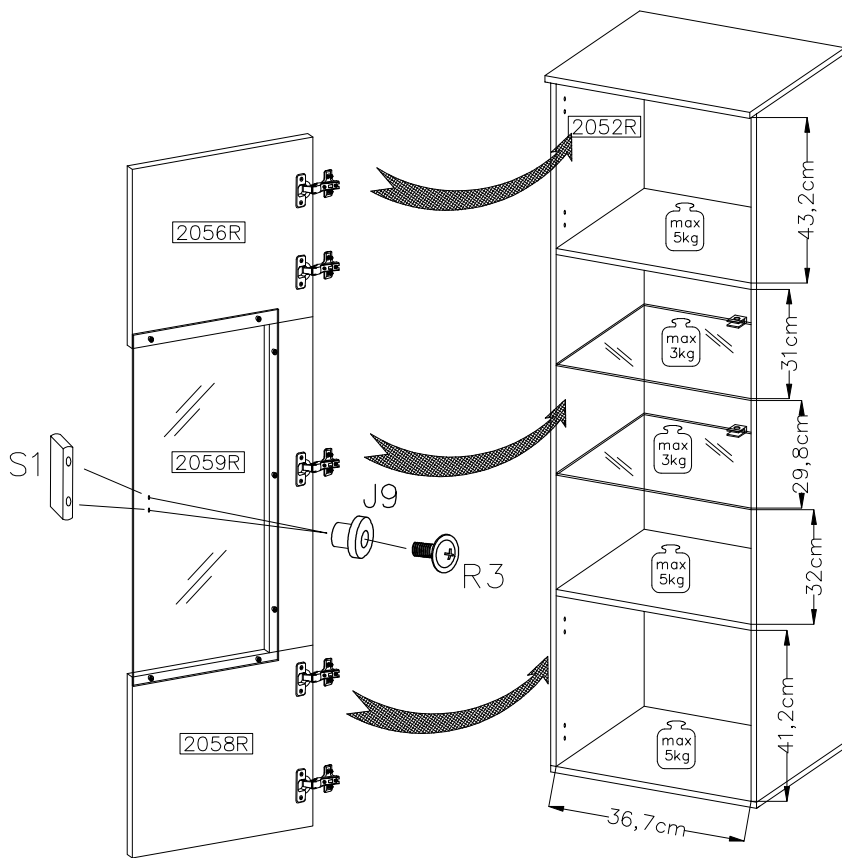

12

∅8.0x50mm		
4	U4	K9
2		

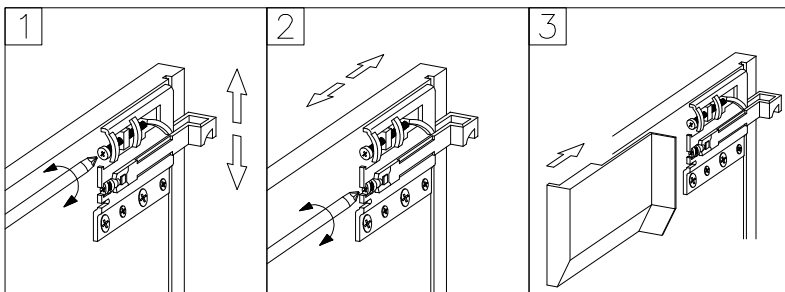
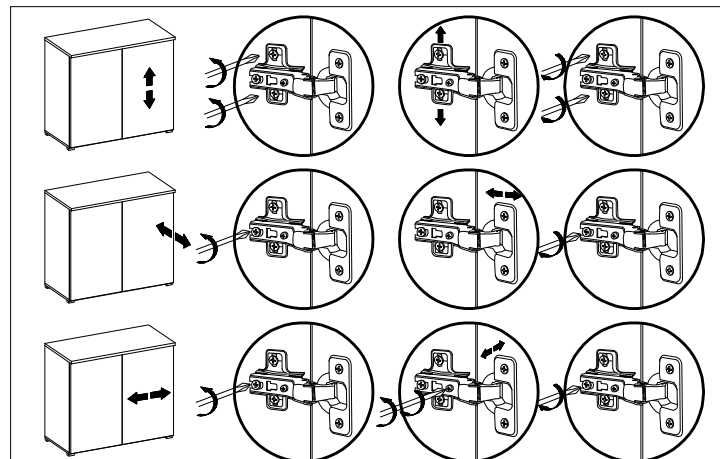
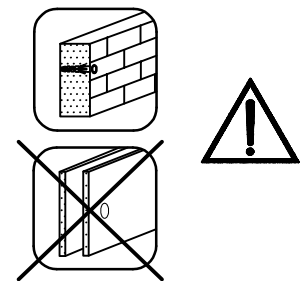
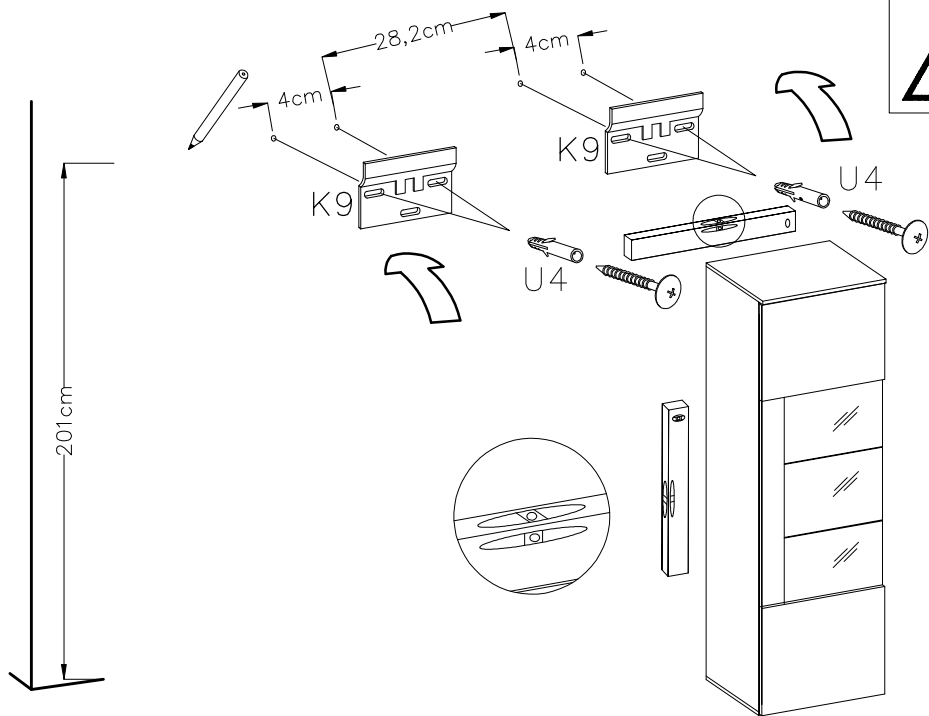

# TIBOR-G

## 10 T3 RM 30

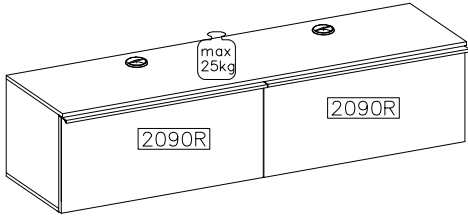
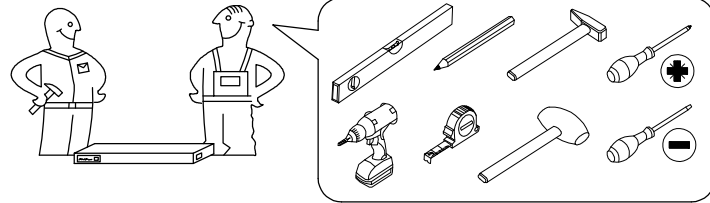

#	ART. NR	L	W	T	Q	Col.No
1	2084R	1736	380	16	1	1
2	2085R	1736	360	16	1	1
3	2086R	320	360	16	1	1
4	2087R	320	360	16	1	1
5	2088R	320	340	16	1	1
6	2089R	320	190	16	2	1
7	2090R	865	332	16	2	1
8	2091R	1718	334	2,5	1	1

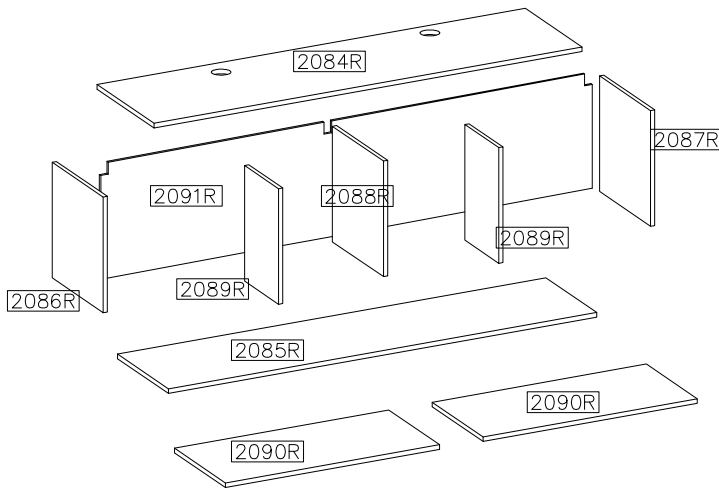
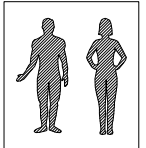
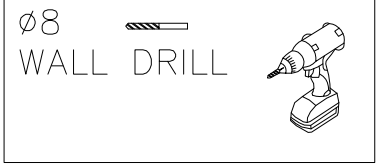
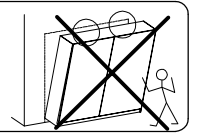
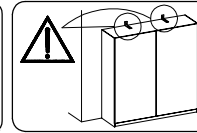
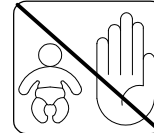
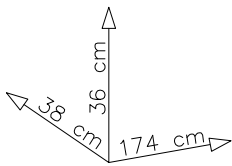
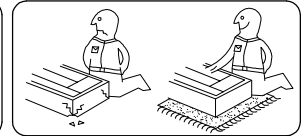
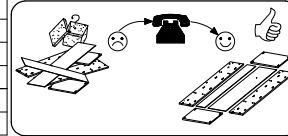
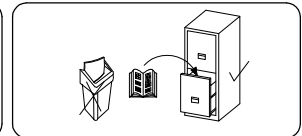
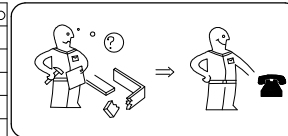



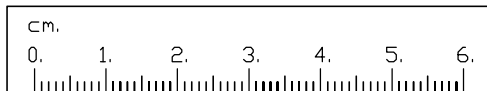

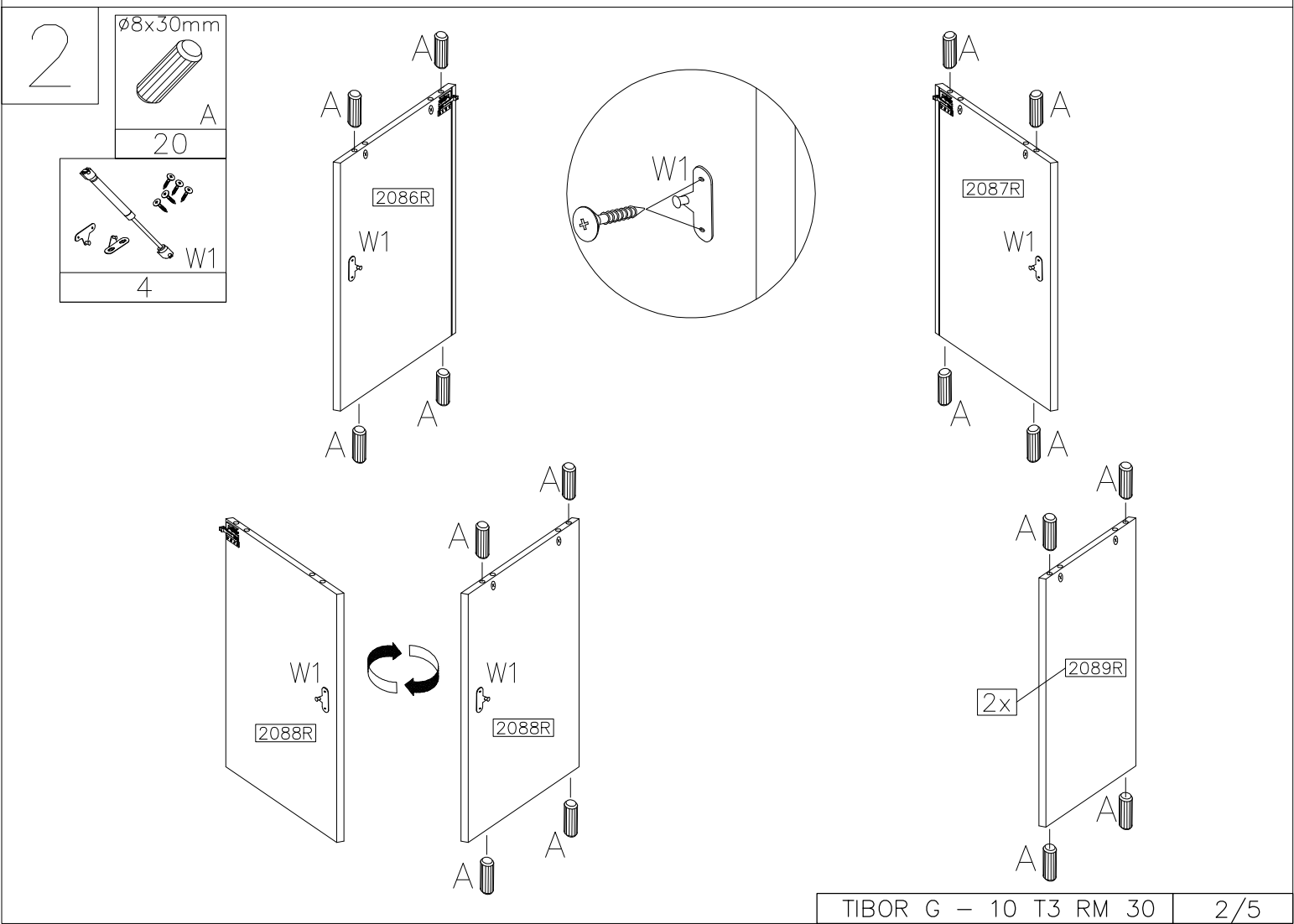
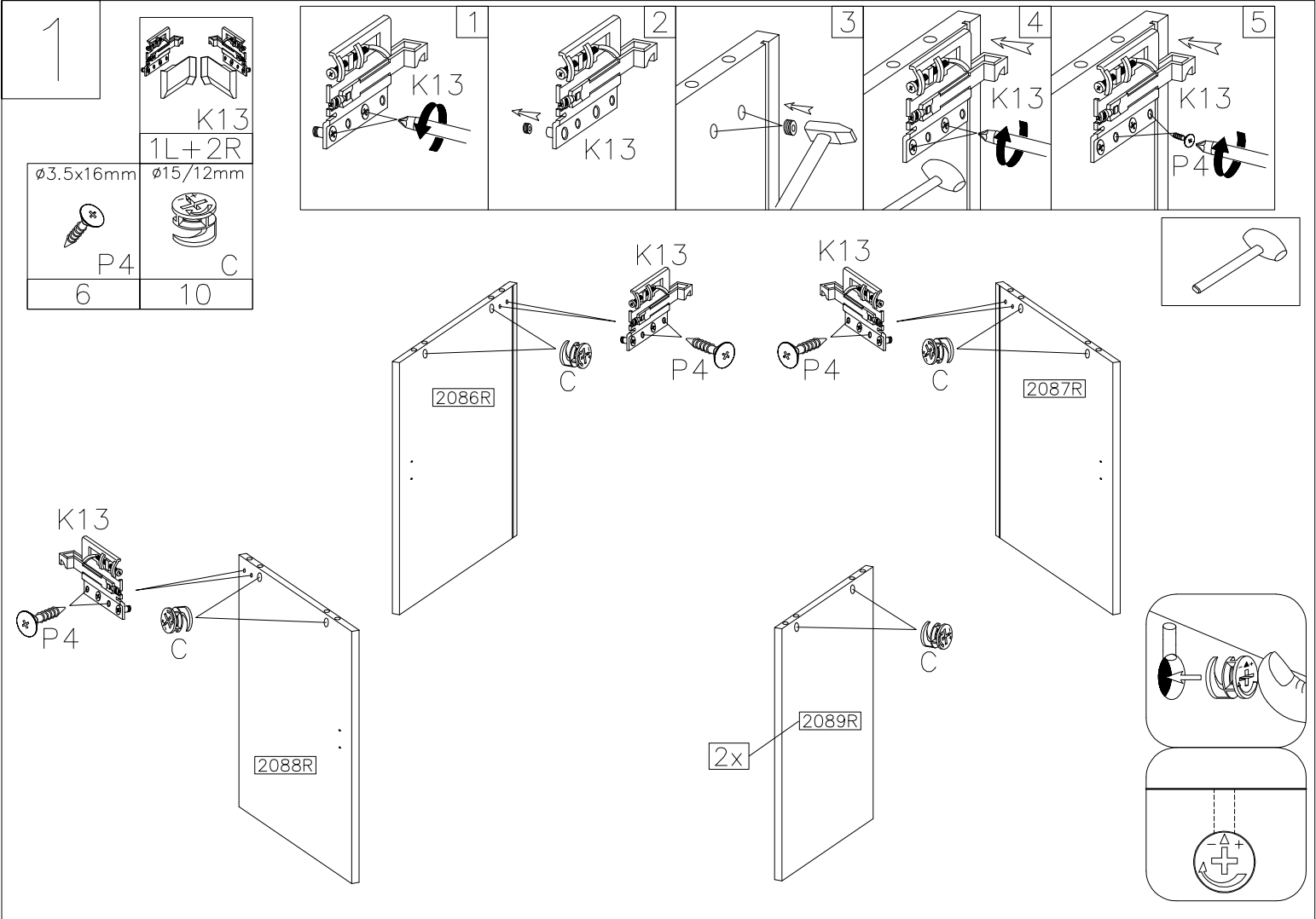
 A	 C	 D1	 E	 G6	 K13	 E7	 W1	 V7	 B	 O
20	10	10	10	4	1L+2R	4	4	2	10	1
 L	 P1	 P4	 P12	 P9	 U4	 K9	 Z11			
10	5	6	4	8	6	3	6			
 V1	 V2	 V3	 V4							
1	1	1	2							





3

	
D1	E7
10	2
ø35/KR-0	5.0x13mm
	
G6	P9
4	8

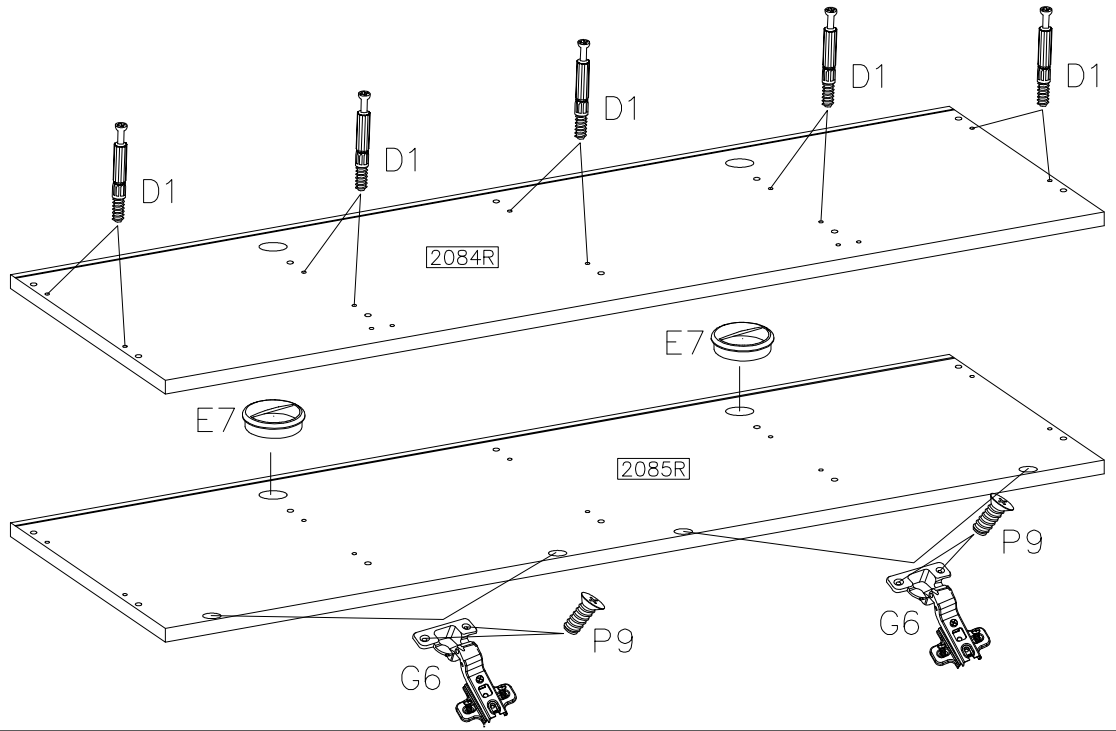
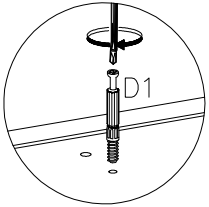

4

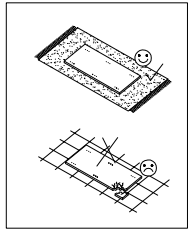
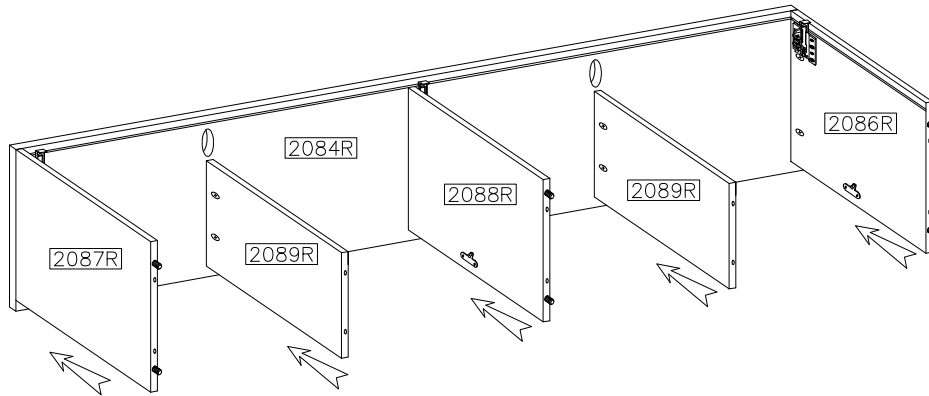
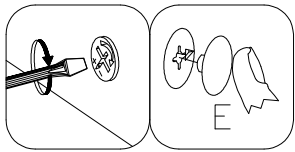

E
10

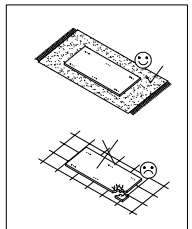
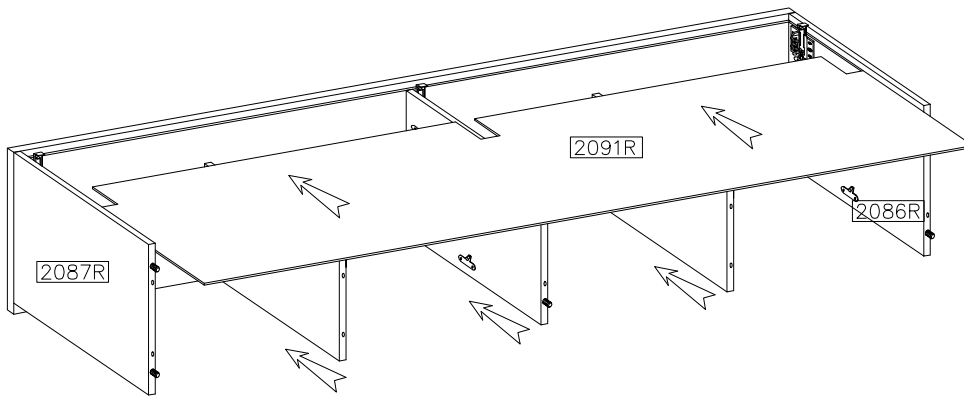

5



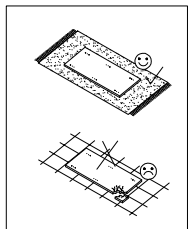
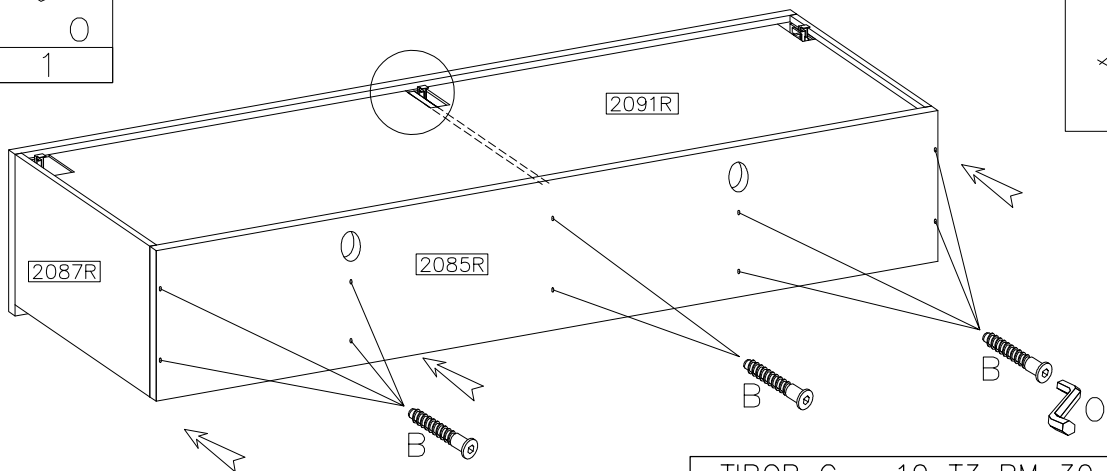
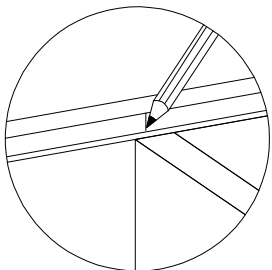

6

	
ø6,4x50mm	4mm
B	O
10	1

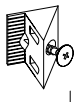

7

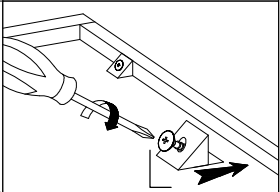
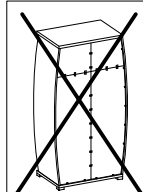
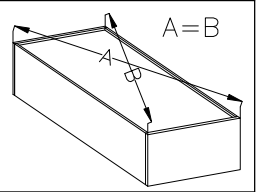
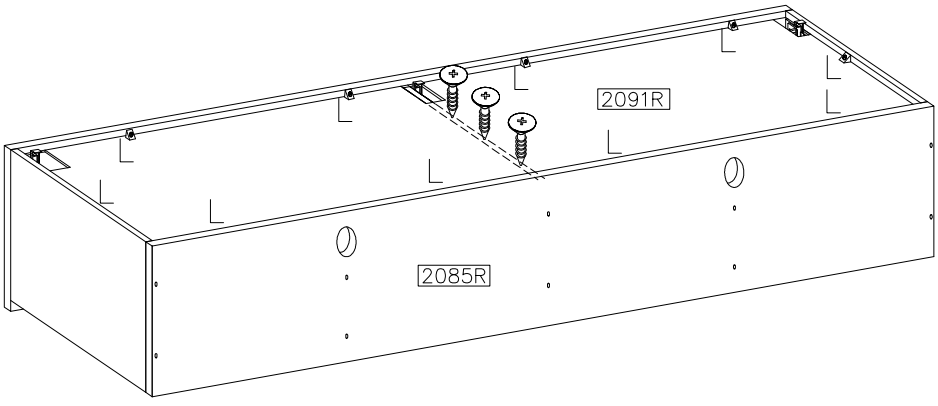

L
10
∅3.0x16mm

P1
5

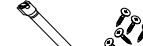

8

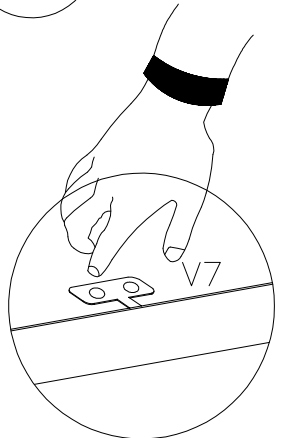
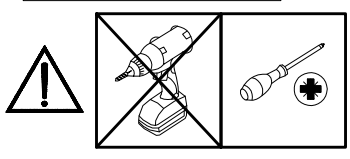
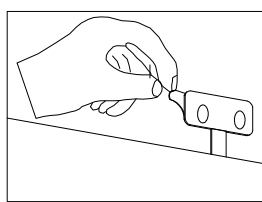
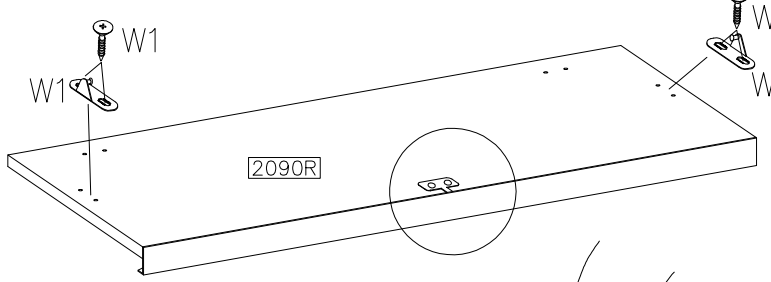
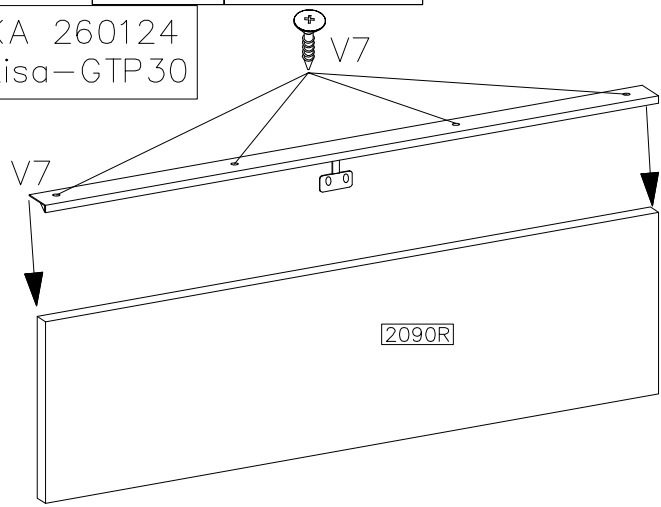



	
V7	W1
2	4

KA 260124  
Lisa-GTP30



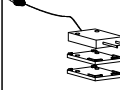

9

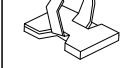
∅4.0x25mm

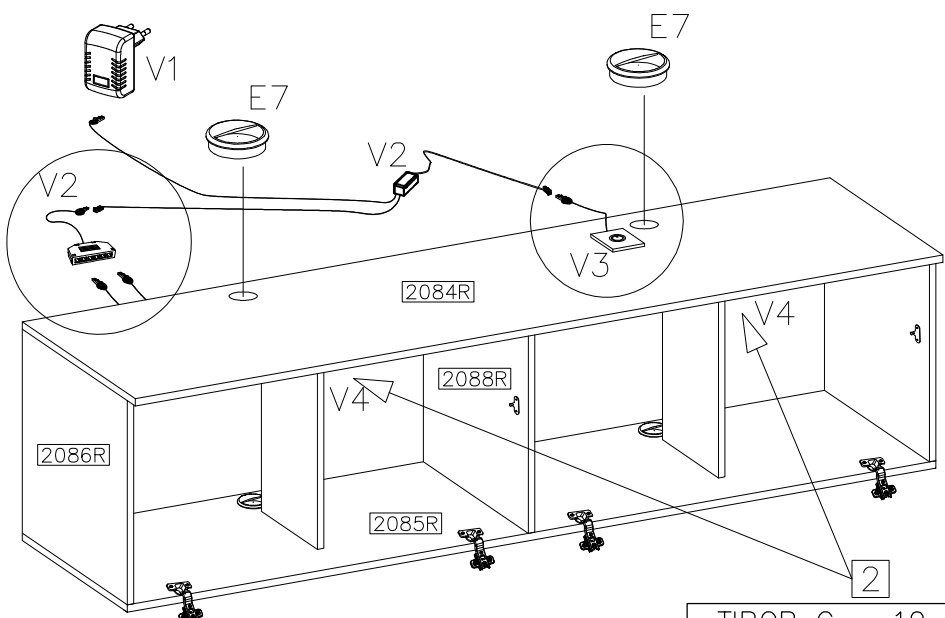
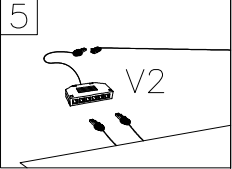
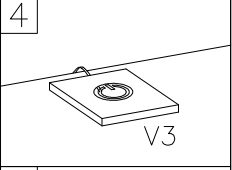
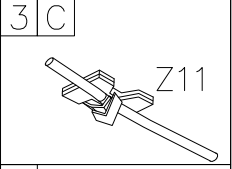
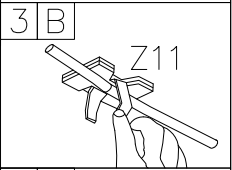
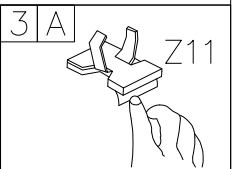
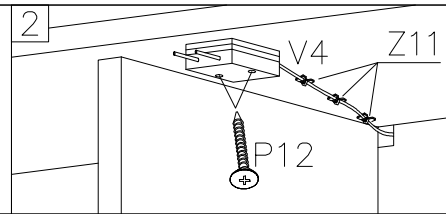
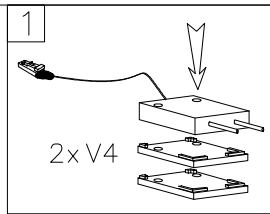
P12
4

	
V1	V2
1	1
	
V3	V4
1	2
	
E7	Z11
2	6

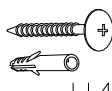

10

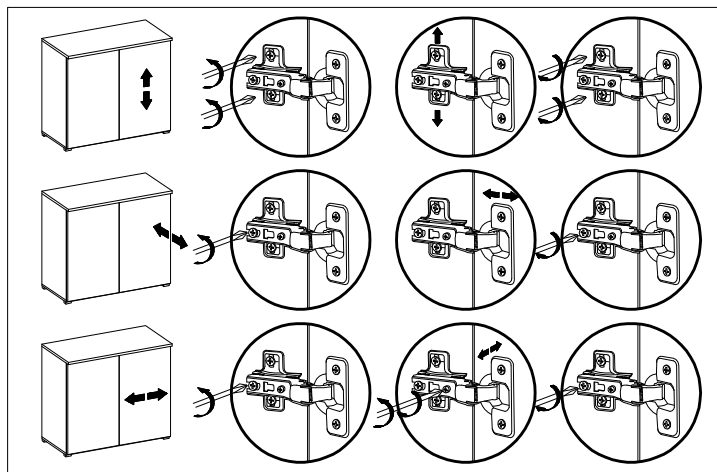
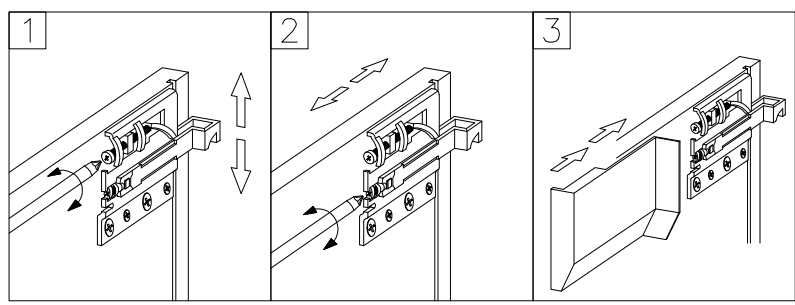
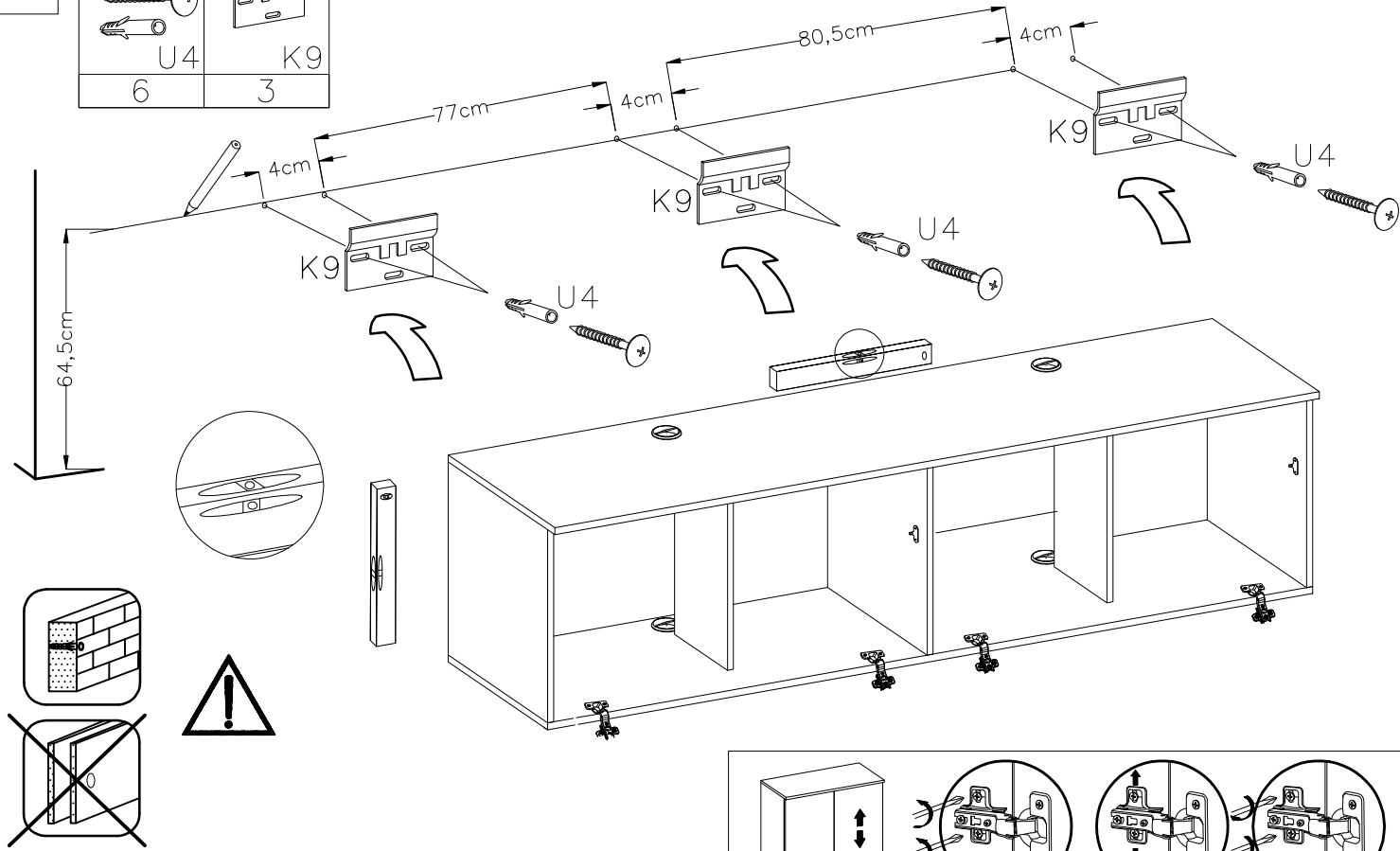
<p>Ø8.0x50mm</p>  <p>U4</p> <p>6</p>	 <p>K9</p> <p>3</p>
---	---

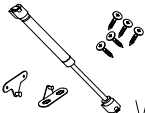

11

 <p>W1</p> <p>4</p>
--

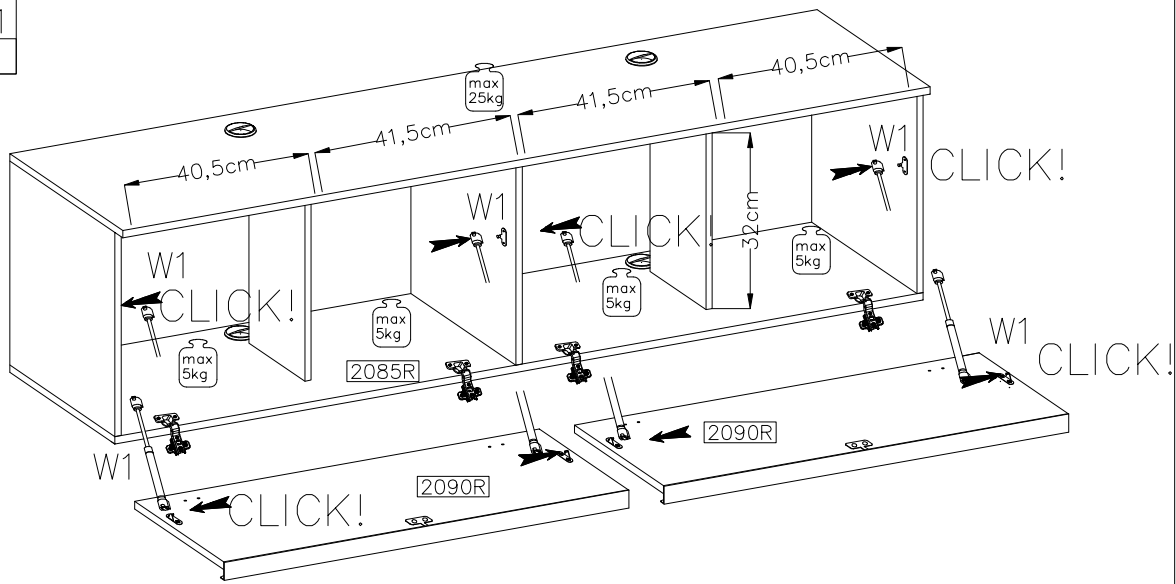
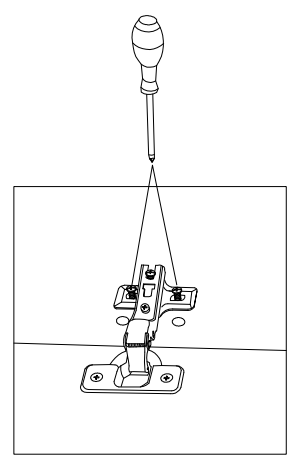

# TIBOR-G

## 10 T3 RM 40

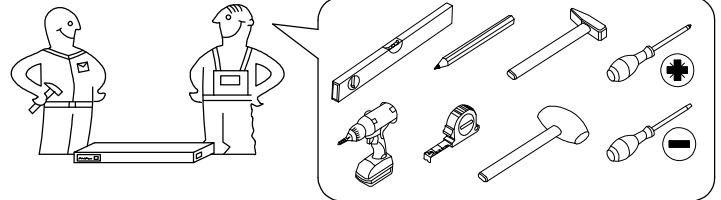



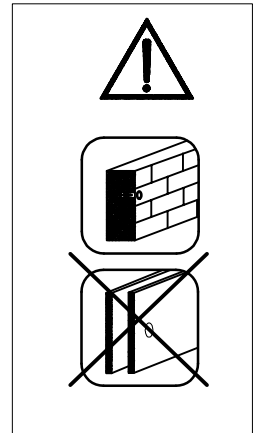
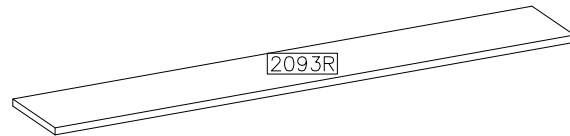
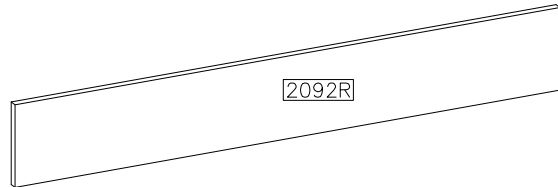
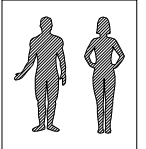
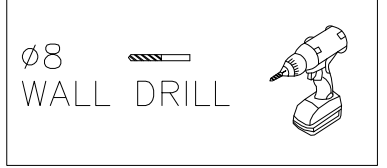
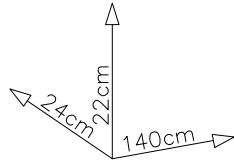
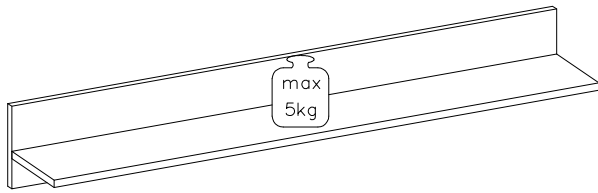
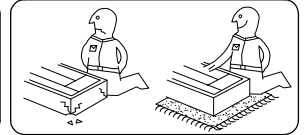
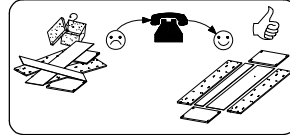
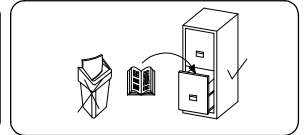
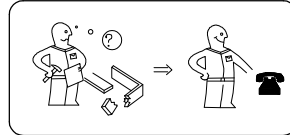

#	ART. NR	L	W	T	Q	Col.No
1	2092R	1403	220	16	1	1
2	2093R	1400	220	22	1	1

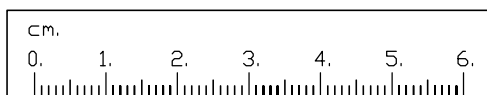

			5.0x9mm	Ø8.0x50mm
B	O	B3	P8	U5
5	1	2	4	2



1

6,3x70mm  B1 5	 O 1	 B3 2	5.0x9mm  P8 4	∅8.0x50mm  U5 2
---	--	---	--	--

