

Carmen, Deco Komoda 1W1D3S

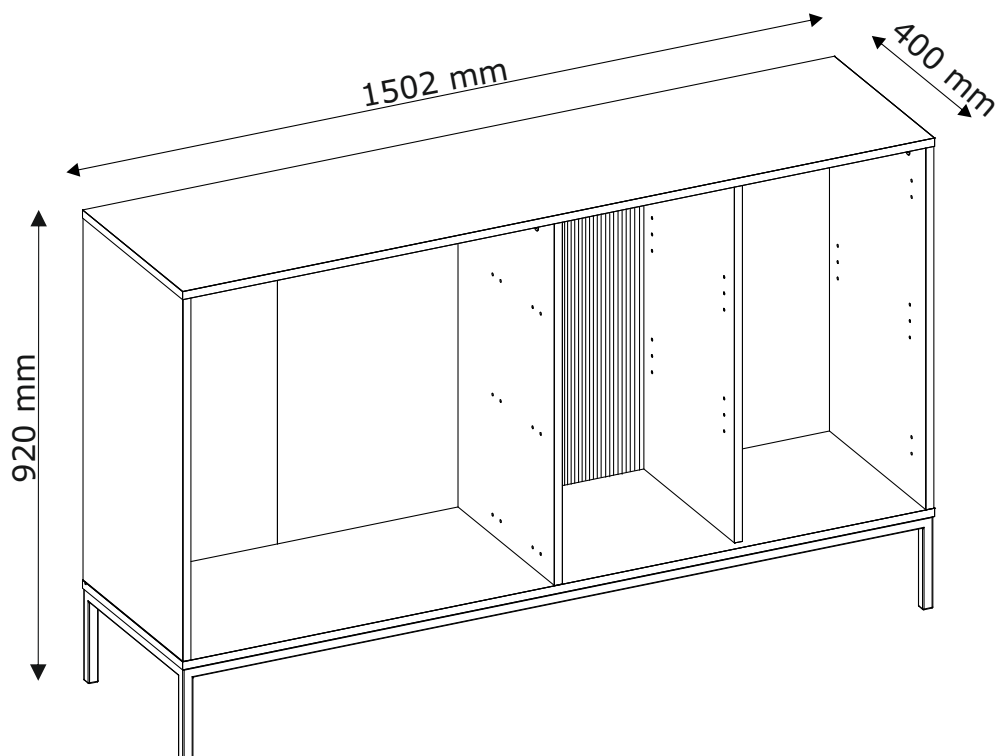

3026168

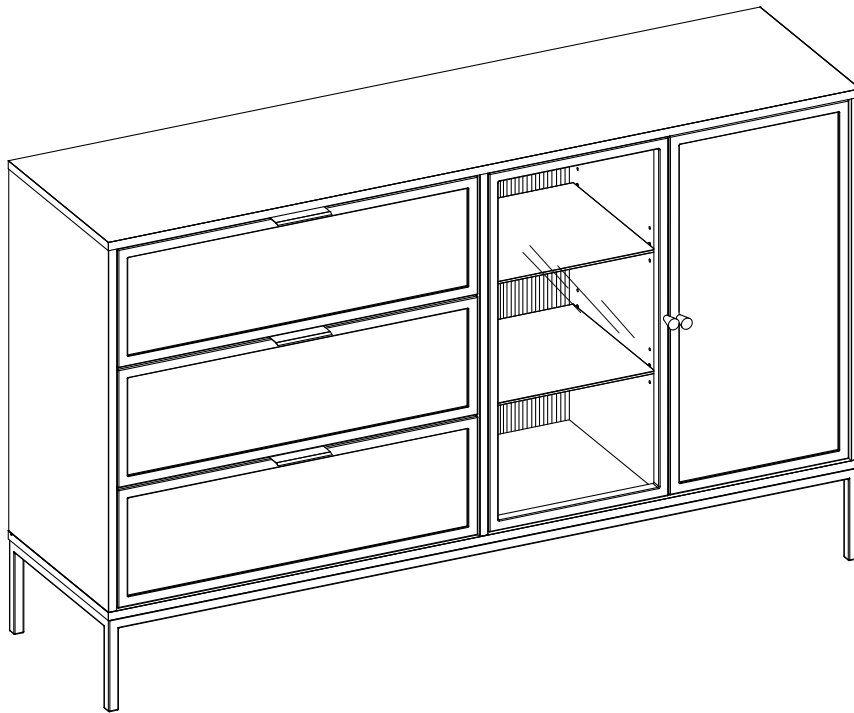
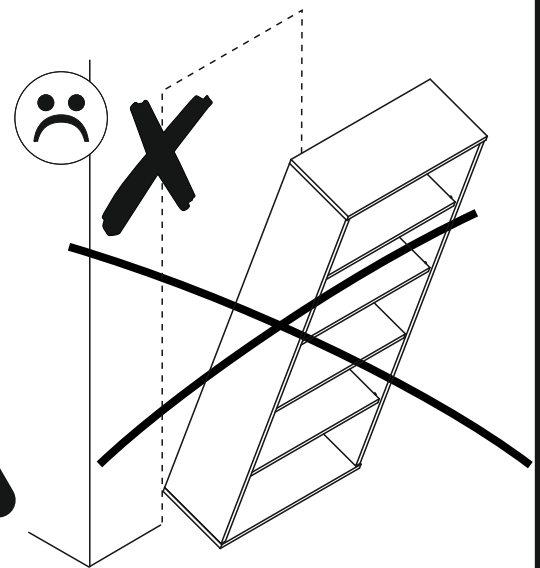
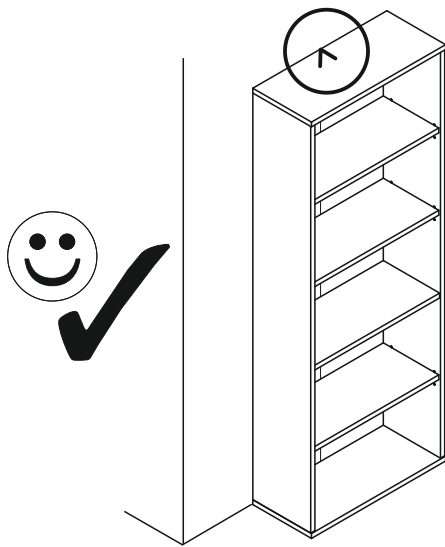

PL.

UWAGA! Mebel należy trwale zamocować do ściany, aby uniknąć ryzyka związanego z przewróceniem się mebla. W paczce znajdują się elementy mocujące odpowiednie wyłącznie do ścian betonowych lub z pełnej cegły. Jeśli Twoja ściana wykonana jest z innego materiału lub nie masz pewności co do budowy tej ściany, skonsultuj się w kwestii montażu ze specjalistą.

RU.

ПРИМЕЧАНИЕ! Эту мебель необходимо всегда прикреплять к стене, чтобы избежать рисков, связанных с переворотом мебели. В пакете находятся крепежные элементы, которые подходят исключительно к бетонным стенам или из целого кирпича. Если стена изготовлена из другого материала или Вы не уверены относительно строения стены, проконсультируйтесь относительно монтажа со специалистом.

I.

ATTENZIONE! Il mobile deve essere permanentemente fissato alla parete per evitare i rischi derivanti da un ribaltamento del mobile. La confezione contiene solo elementi di fissaggio adatti per pareti in calcestruzzo o in laterizio pieno. Se la vostra parete è realizzata in materiale diverso o avete dubbi sulla costruzione della parete, consultare uno specialista per un montaggio corretto.

SLO.

POZOR! Pohištvó trajno pritrđite na steno, da preprečíte tveganje, da se prevrne. V paketu so pritrđilni elementi, ki so ustrezni izključno za betonske stene in za stene iz polne opeke. Če je vaša stena izdelana iz drugih materialov ali niste gotovi glede konstrukcije stene, se o montaži posvetujte s strokovnjakom.

EN.

WARNING! To prevent this furniture from tripping over, fix it to the wall permanently. The package includes fastening elements only suitable for concrete or full-brick walls. If your wall is made of a different material or you are unsure as to the construction of the wall, please consult a specialist regarding installation.

FR.

ATTENTION! Ce meuble doit être fixé en permanence au mur pour éviter les risques de chute. L'ensemble comprend des moyens de fixation adaptés uniquement aux murs de béton ou de brique. Si votre mur est fait d'un matériau différent ou si vous êtes incertain quant à la construction du mur, consultez un spécialiste.

HR.

NAPOMENA! Namještaj mora biti trajno pričvršćen za zid, kako bi se izbjegao rizik od njegova prevrtanja. U paketu se nalaze elementi za pričvršćivanje prikladni isključivo za betonske zidove ili punu ciglu. Ako je Vaš zid izrađen od drugog materijala ili niste sigurni od čega je napravljen Vaš zid, konzultirajte se sa stručnjakom u vezi sa montažom.

CZ.

POZOR! Nábytek je nutné pevně připevnit ke zdi, abychom se vyhnuli riziku spojenému s jeho převrnutím. V balíčku se nacházejí připevňující prvky vhodné výhradně do betonových zdí nebo zdí z plných cihel. Pokud jsou Vaše zdi zhotoveny z jiného materiálu nebo si nejste jejich konstrukcí jisti, konzultujte otázku montáže se specialistou.

CN.

注意！本家具需要固定在墙上以免倒塌。本包所含有的固定部件仅适用于混凝土墙及整砖墙。欲使用在其他墙体或不确定墙体时，请向专家询问安装方式。

D.

ACHTUNG! Um alle mit dem Umkippen des Möbels verbundenen Risiken auszuschließen, muss das Möbel fest an der Wand verankert werden. Die im Paket enthaltenen Beschläge für die Wandbefestigung sind ausschließlich für Wände aus Beton oder Vollziegeln geeignet. Sollten die heimischen Wände aus anderem Baumaterial bestehen oder sollte es Zweifel in Hinsicht auf dieses Baumaterial geben, bitte eine Fachkraft zu Rate ziehen.

HU.

FIGYELEM! Rögzítse a bútorokat a falhoz, hogy elkerülje a bútor felborulásának kockázatát. A készletben kizárólag beton- vagy téglafalhoz használható kötőelemek találhatók. Ha a fal más anyagból készült, vagy ha nem tudja, milyen falak találhatók otthonában, forduljon szakemberhez.

SK.

POZOR! Nábytok musí byť trvalo pripevnený k stene tak, aby sa zamedzilo riziku prevrátenia. V balíku sa nachádzajú upevňovacie komponenty výlučne pre betónové steny alebo steny z plnej tehly. Ak je Vaša stena z iného materiálu alebo ak si nie ste istí, z čoho je stena vyhotovená, vyžiadajte si odbornú pomoc.

E.

¡ATENCIÓN! El mueble debe ser fijado permanentemente a la pared para evitar el riesgo relacionado con el vuelco del mueble. En el paquete hay elementos de fijación adecuados solo para paredes de hormigón o de ladrillo entero. Si su pared está hecha de otro material o no está seguro sobre la construcción de esta pared, consulte el montaje con un especialista.

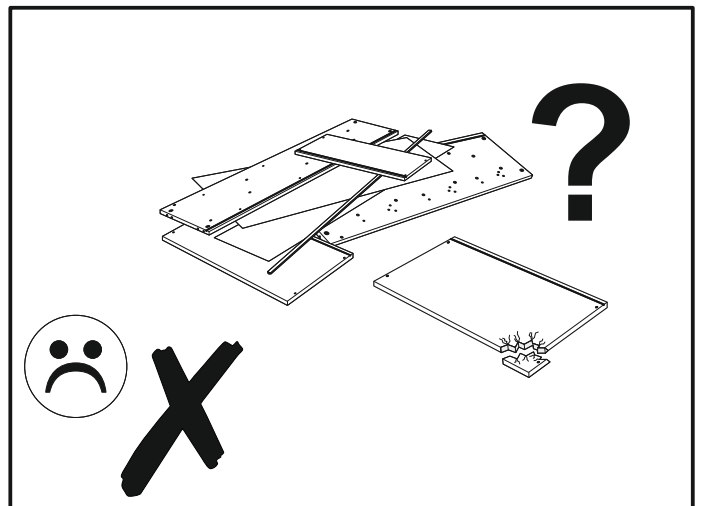
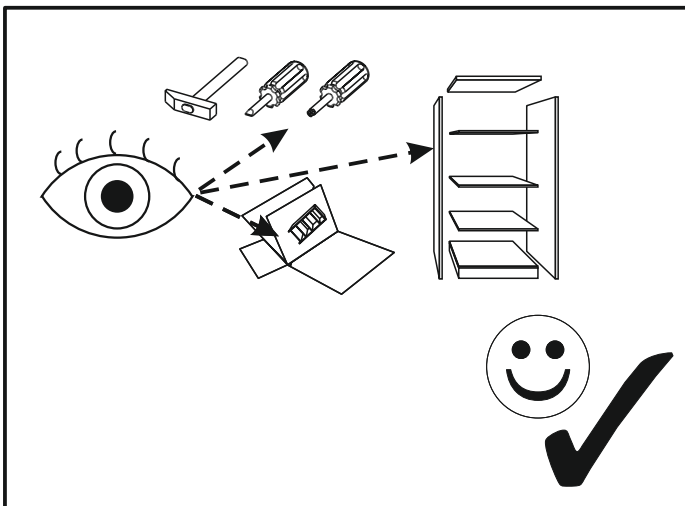
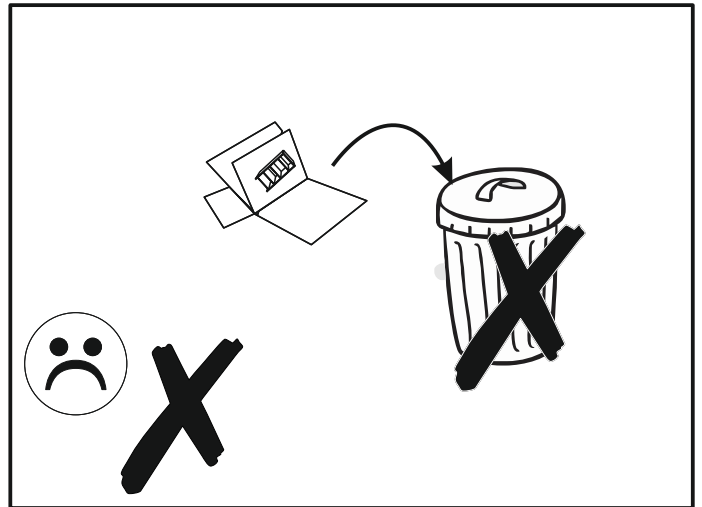
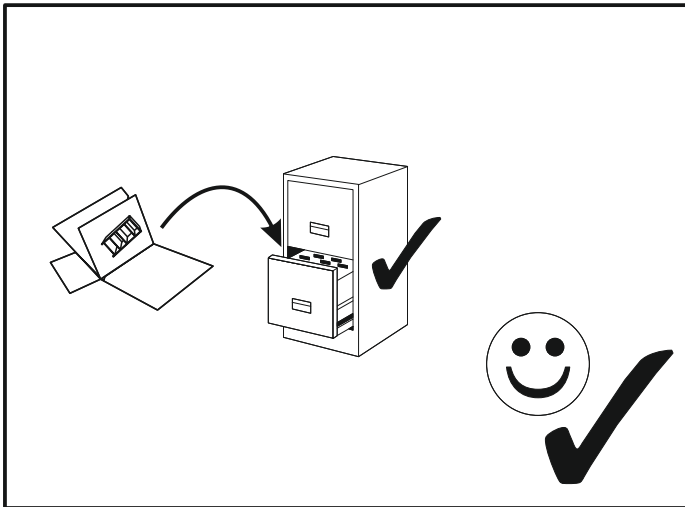
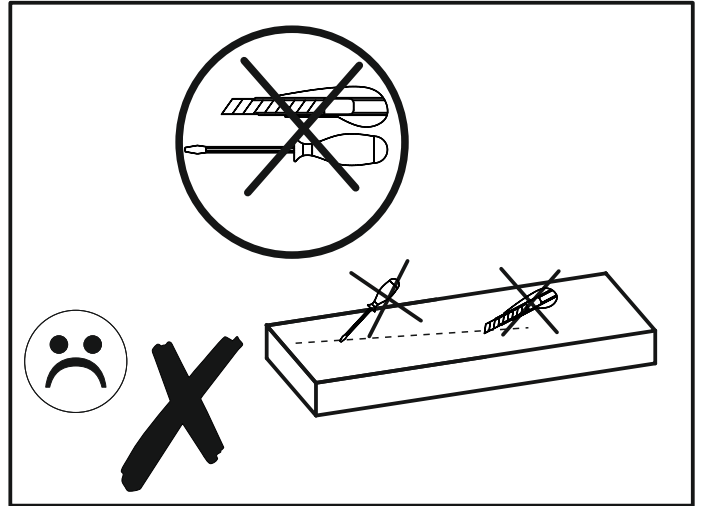
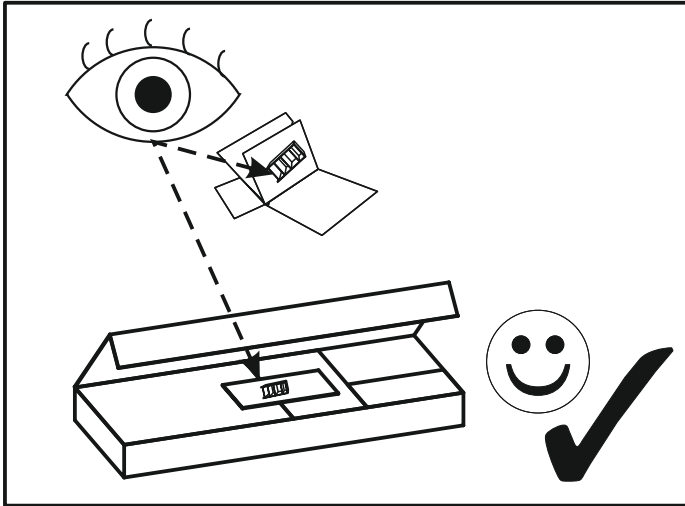

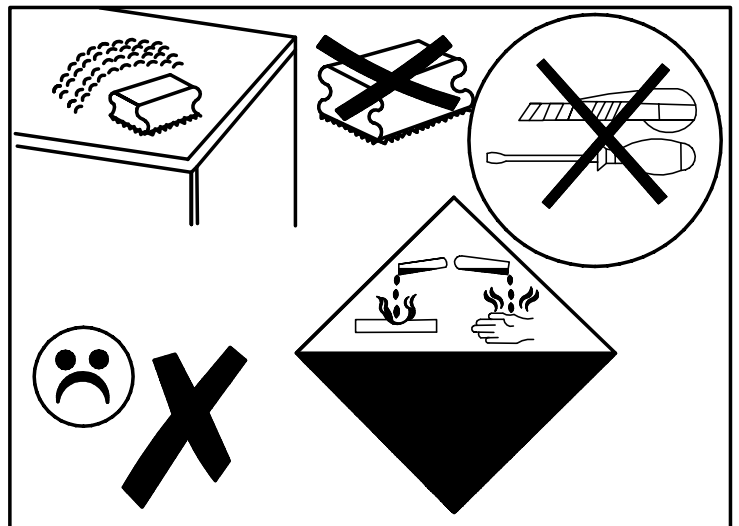
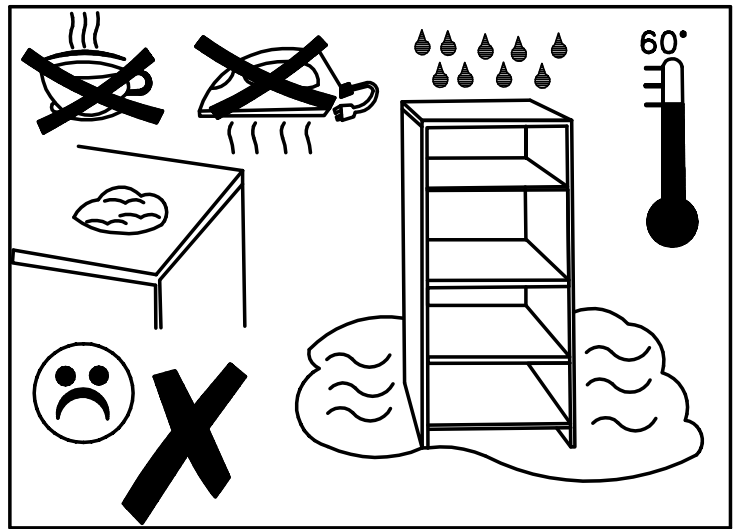
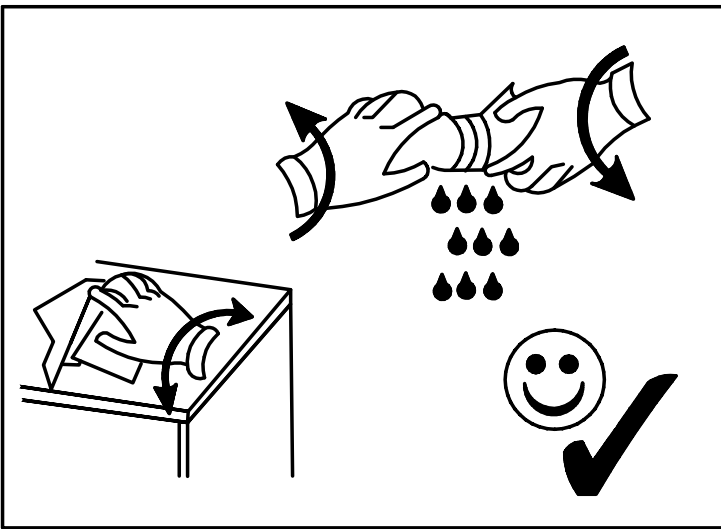
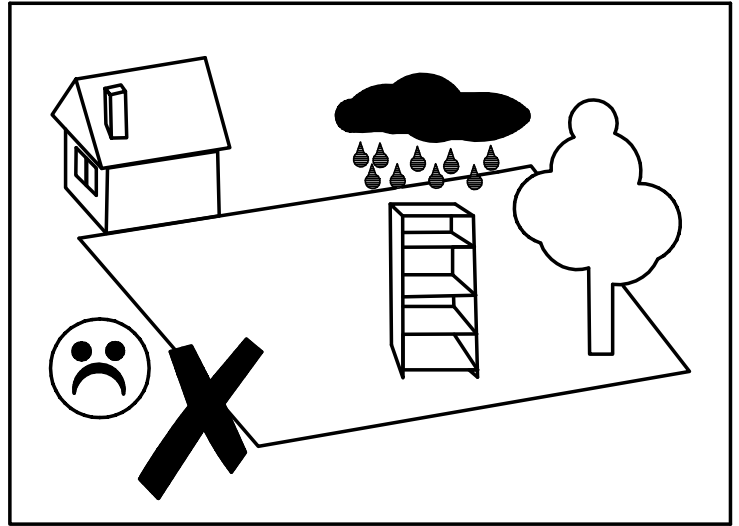
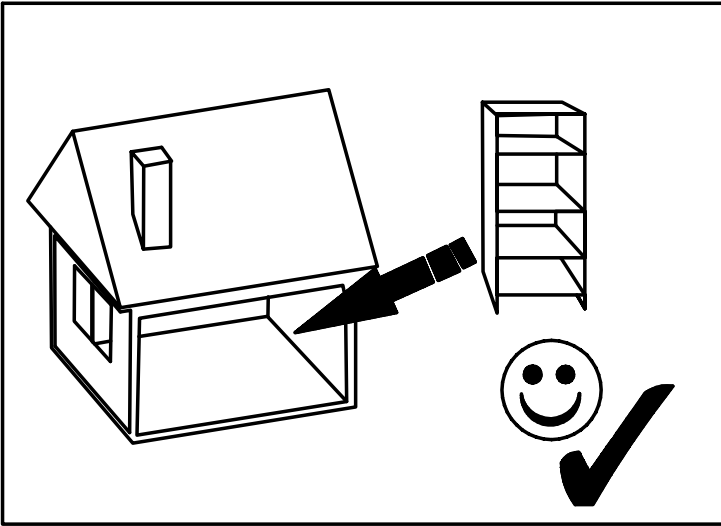

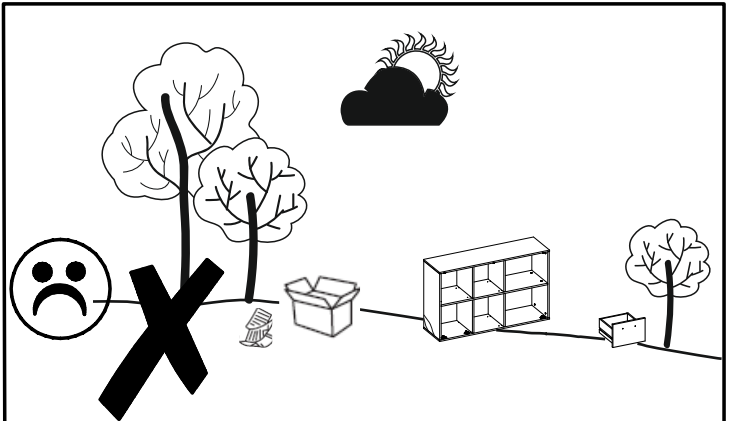
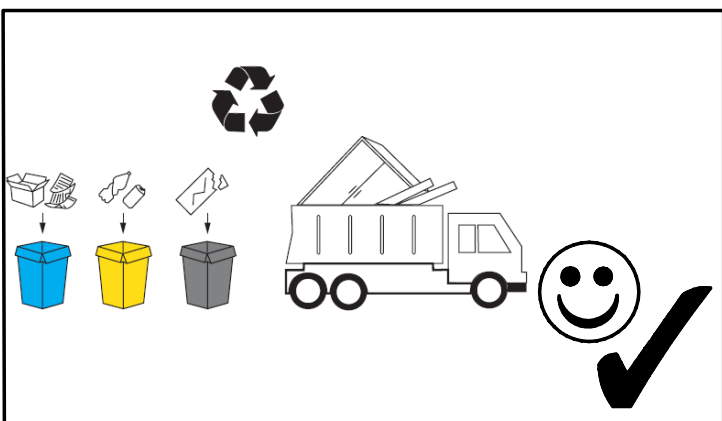
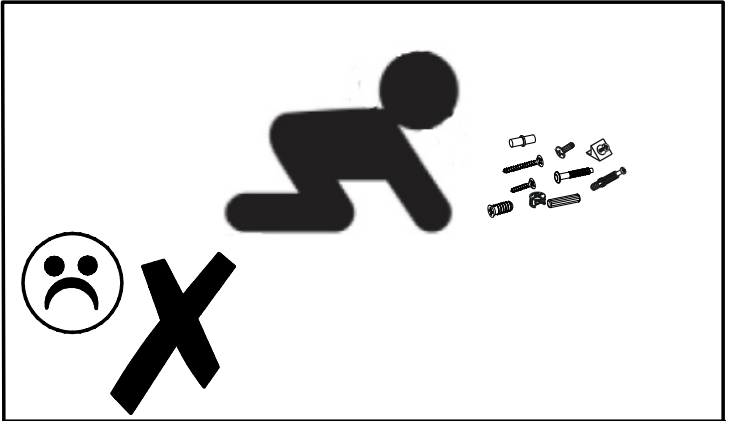
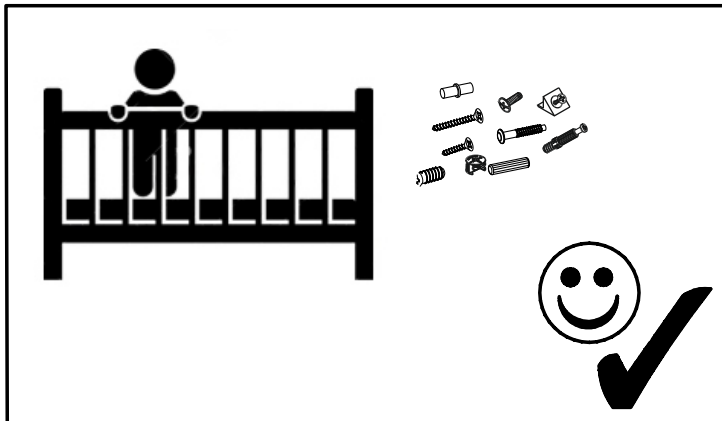
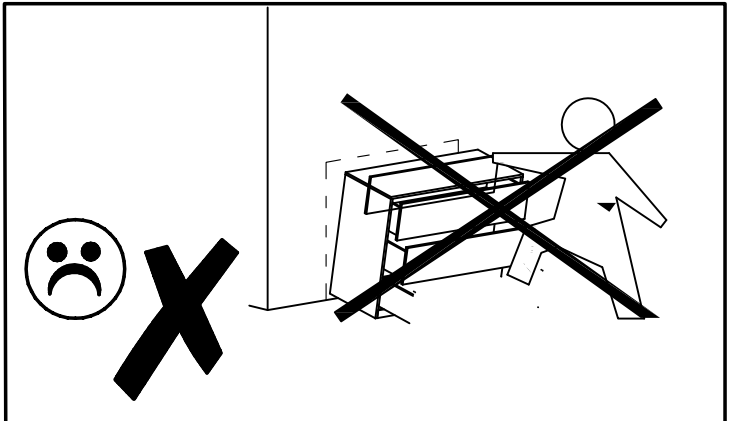
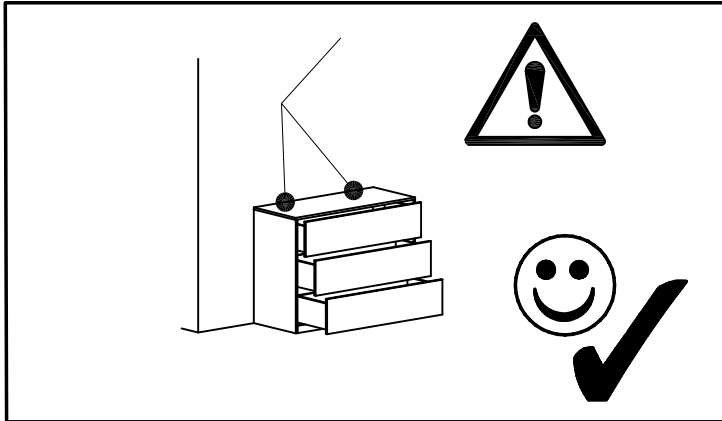
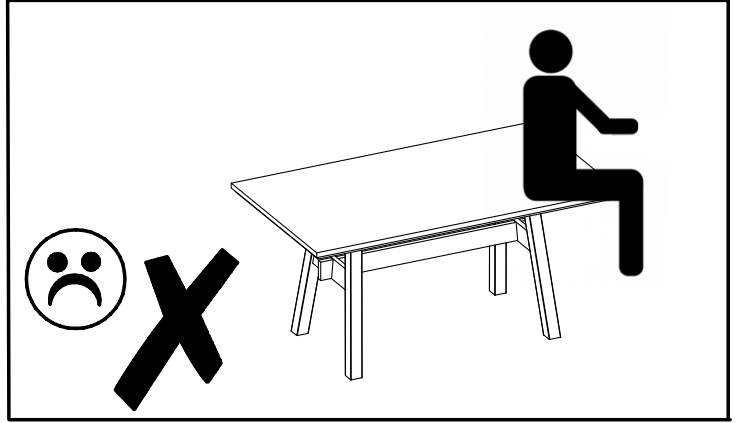
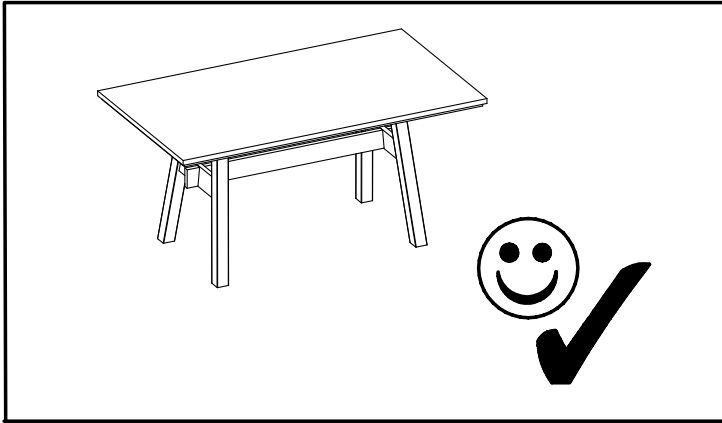

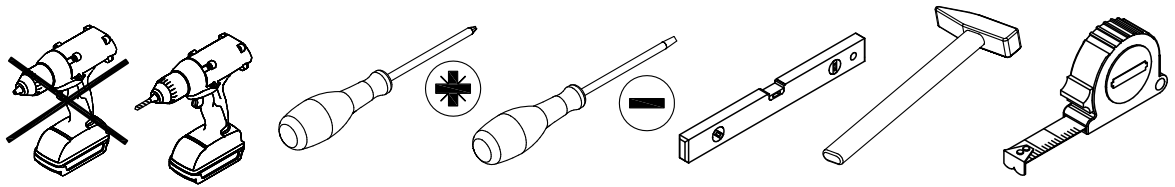

A x 16
3003605

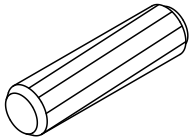

Ø8x35 mm

A1 x 12
3005048

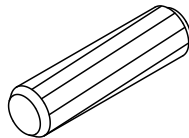

Ø6x30 mm

B x 10
3000534

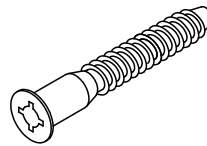

Ø7x50 mm

B2 x 4
3003334

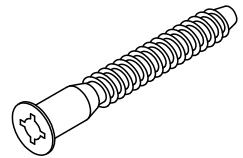

Ø7x70 mm

C x 8
3001728



Ø15x12 mm

C1 x 12
3002649

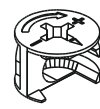

Ø15x10 mm

D x 20
3002942

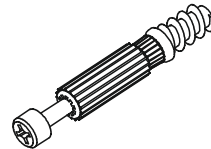

Ø5x44 mm

E x 1
3000331

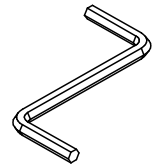

4 mm

F x 8
3020881



20 mm

F1 x 12
3011364



20 mm

G2 x 18
3000344

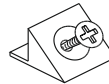

1,2x25 mm

H x 10
3002435

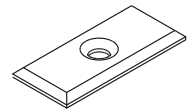

22x9x2 mm

I x 2
3002892

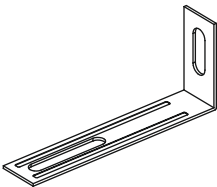

J x 1

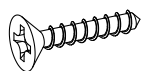

3,5x16 mm

J1 x 6
3000573

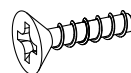

3,5x13 mm

L x 4
3005411

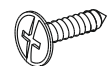

4x16 mm

L1 x 25
3003843

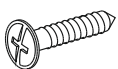

3x20 mm

M1 x 24
3000564



Ø6,3x13 mm

N8 x 3
3000321

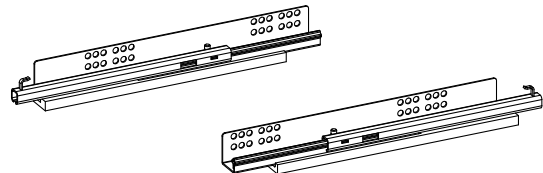

350 mm

O x 4
3000454

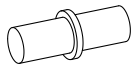

Ø5mm

O2 x 8
3003216

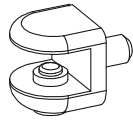

Ø5mm

P x 3
3022484
3013287

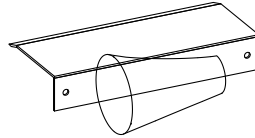

P1 x 6
3023274



2,5x12 mm

P2 x 2
3028018

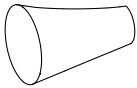

P3 x 1
3000553

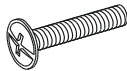

P4 x 1
3026787

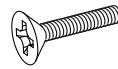

4x25 mm

R6 x 2
3015877

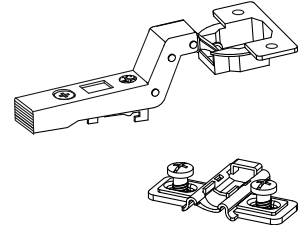

R10 x 2
3026813

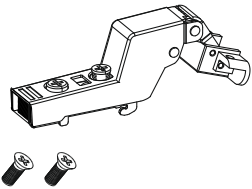

R11 x 2
3026845

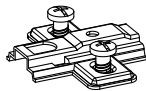

S x 2
3011837



Z2 x 4
3002656

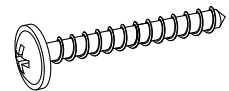

4x35 mm

AL. x 1

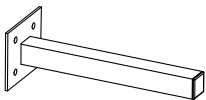

AK x 1
3022351

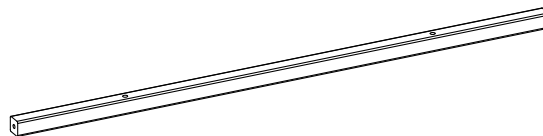

Ak1 x 1
3023250

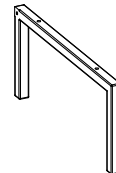

Ak2 x 1
3023275

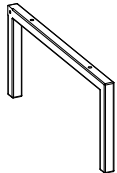

Ak3 x 1
3023279

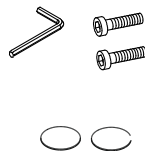

LED x 1
3025278



LED1 x 1
3026198

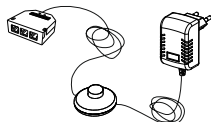

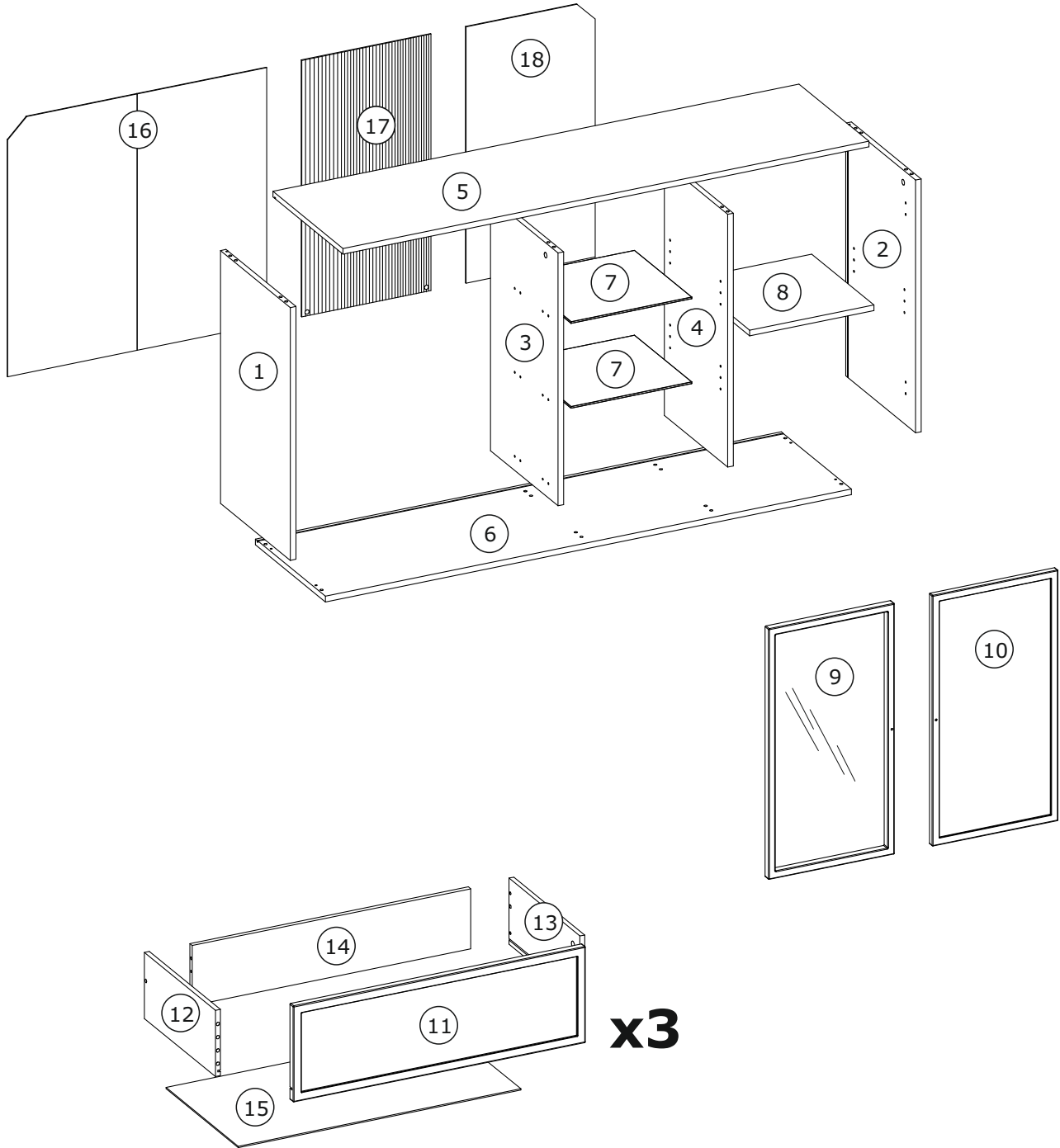
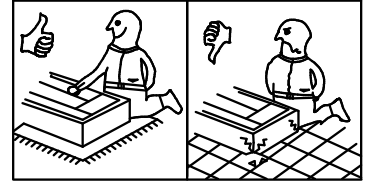

x3

BOX 1/2:

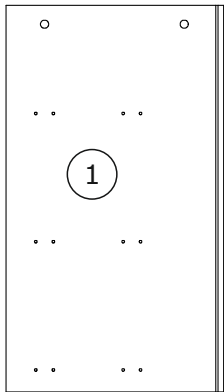

708x399x16 mm

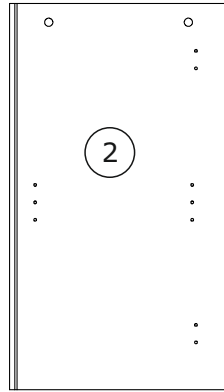

708x399x16 mm

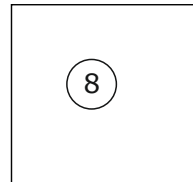

356x355x16 mm

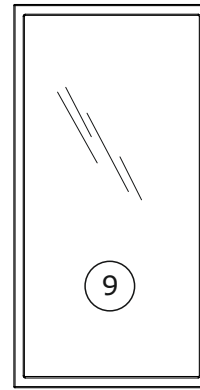

702x359x21 mm

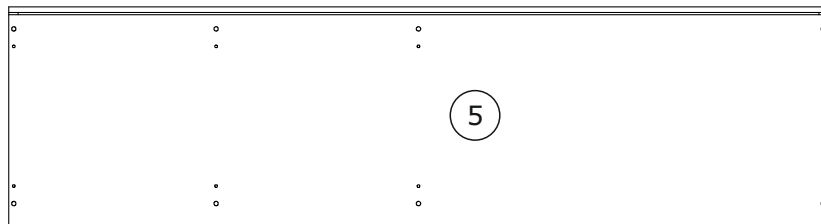

1502x400x16 mm

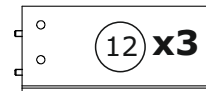

350x160x12 mm

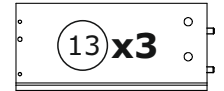

350x160x12 mm

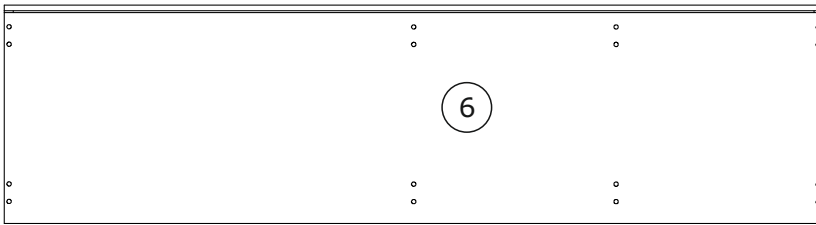

1502x400x16 mm

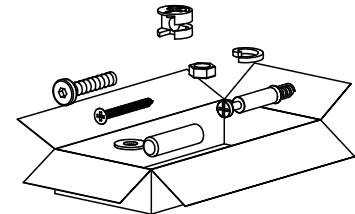

BOX 2/2:

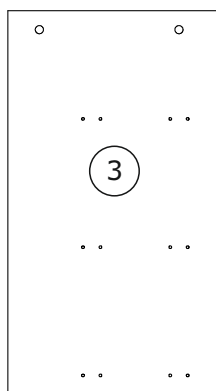

708x385x16 mm

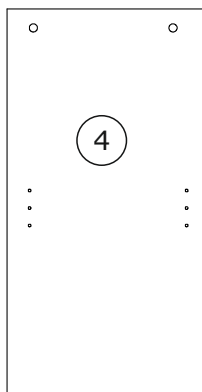

708x385x16 mm

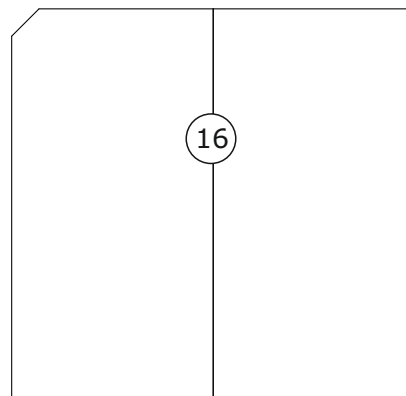

718x740x3 mm

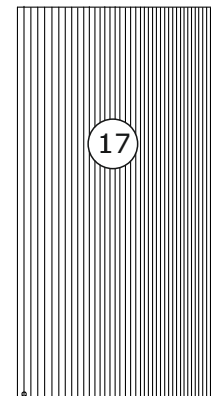

718x369x3 mm

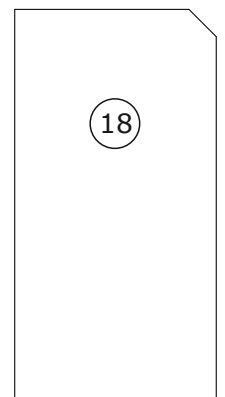

718x369x3 mm

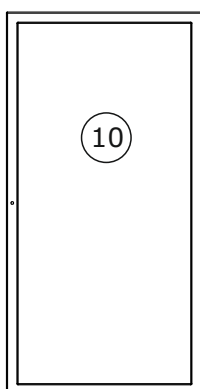

702x359x17 mm

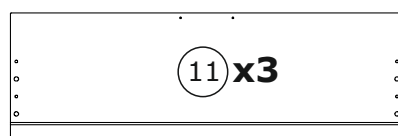

720x320x17 mm

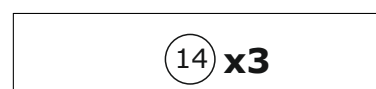

686x145x12 mm

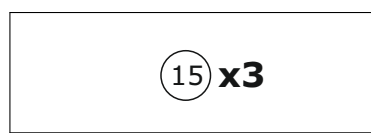

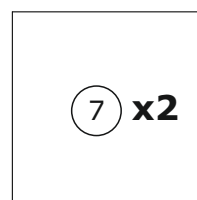

696x356x3 mm



345x327,5x5 mm

1

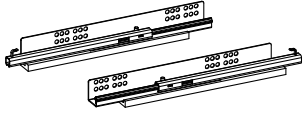
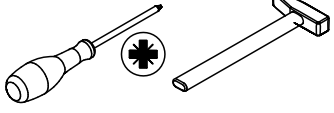
A x 8  Ø8x35 mm	R11 x 2 	M1 x 24  Ø6,3x13 mm	N8 x 3  350 mm	
--	--	--	--	---

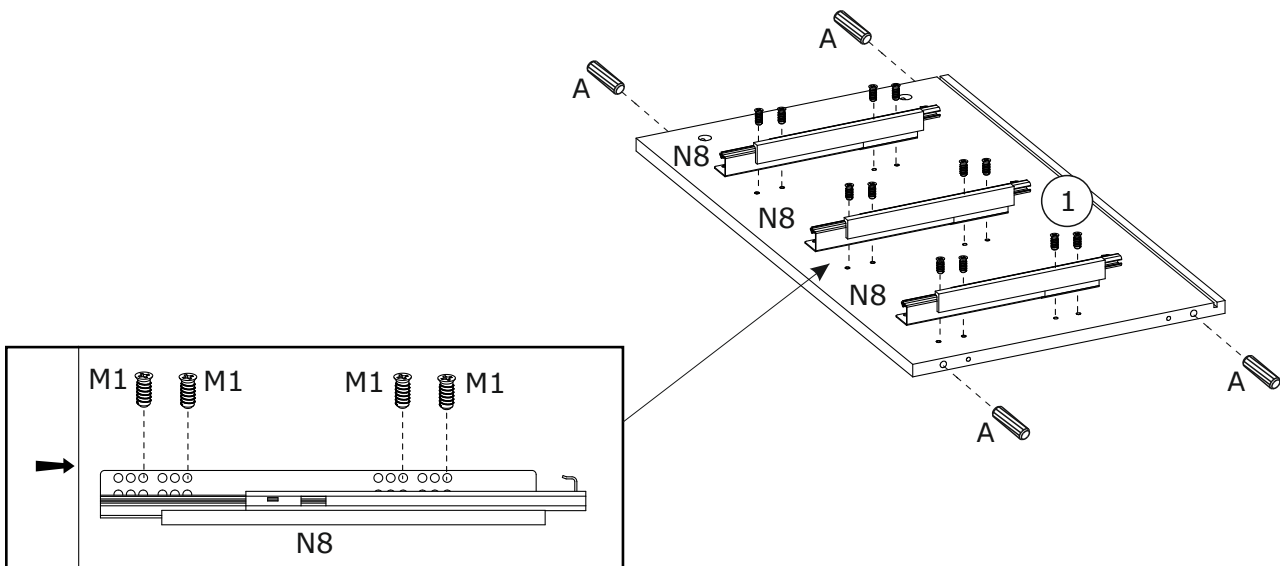
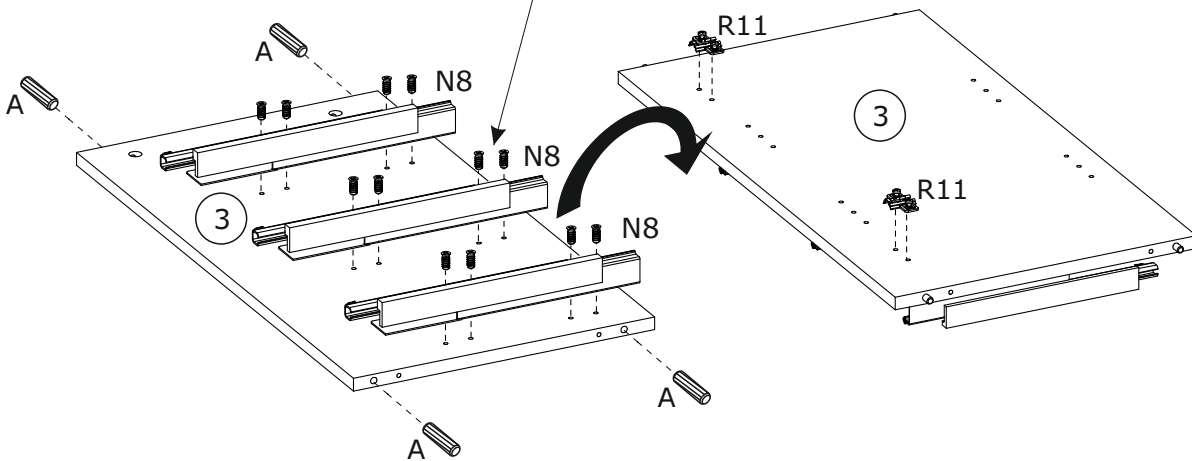
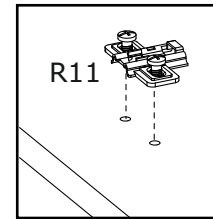
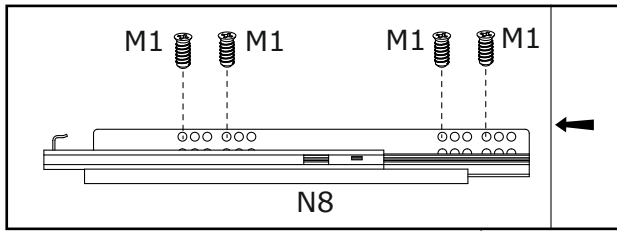
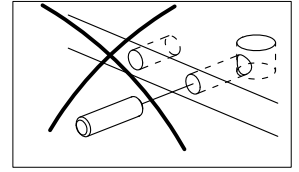
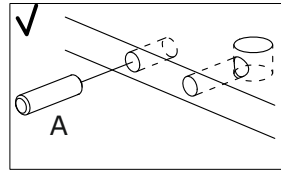

2

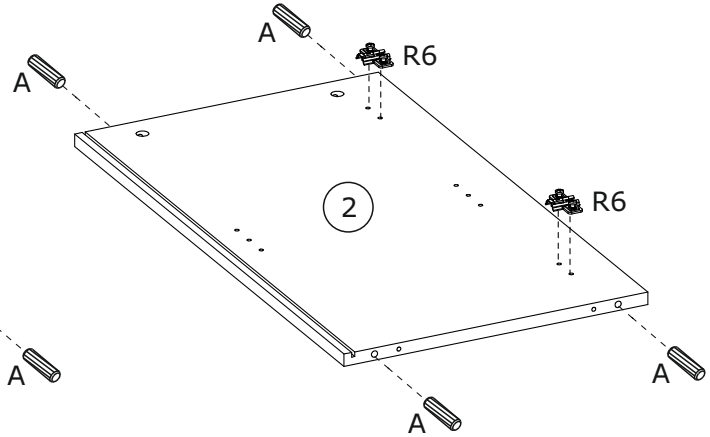
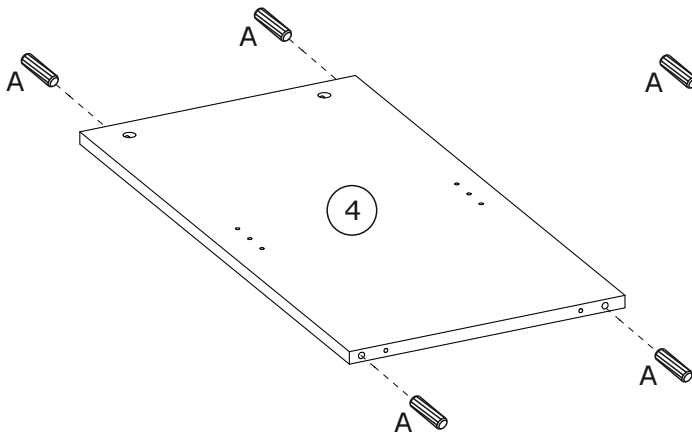
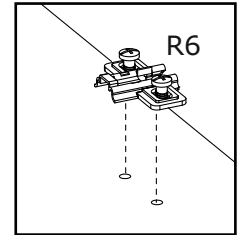
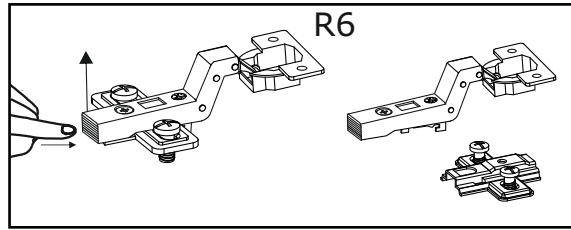

3

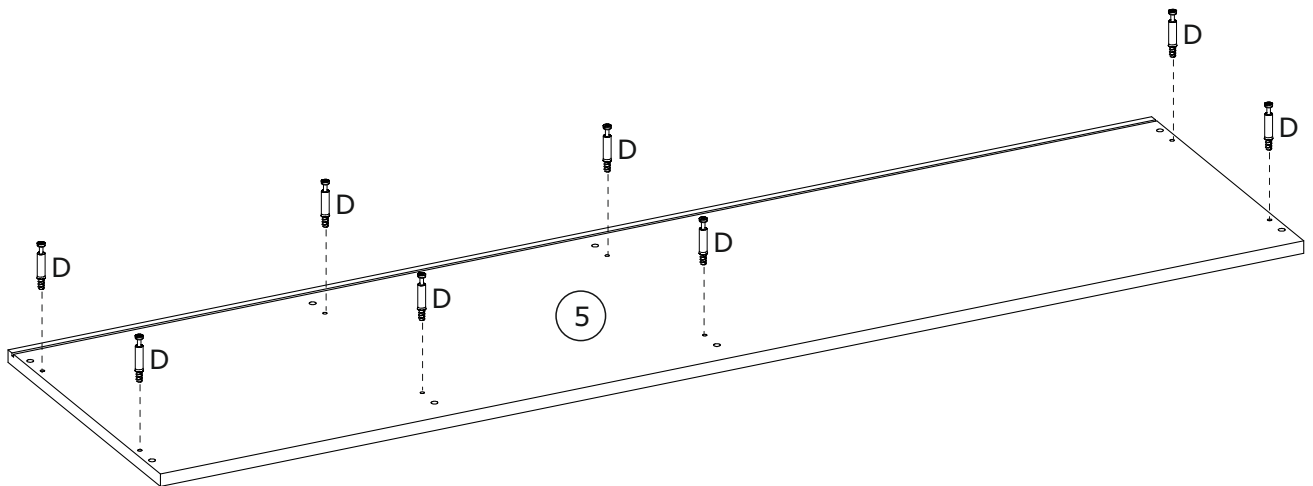
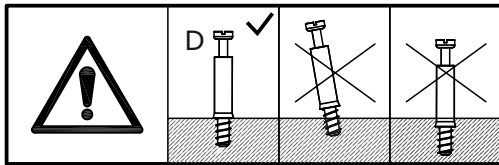



4

C x 8

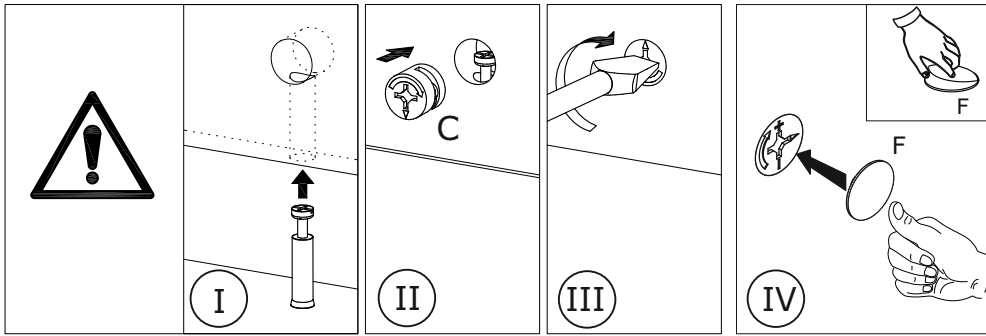
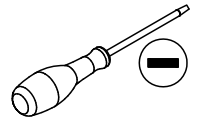
Ø15x12 mm

F x 8

20 mm

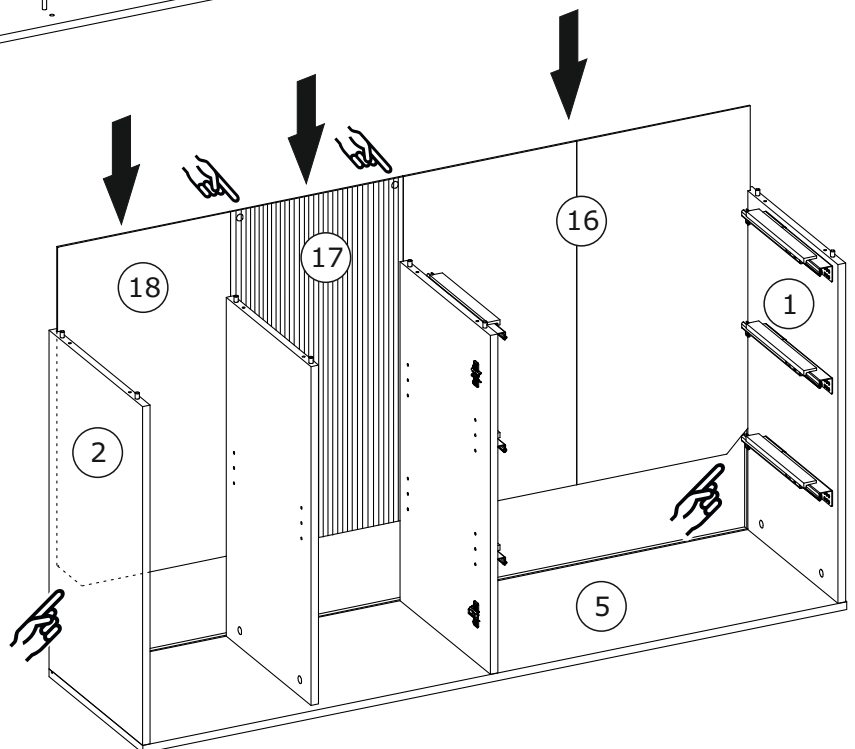
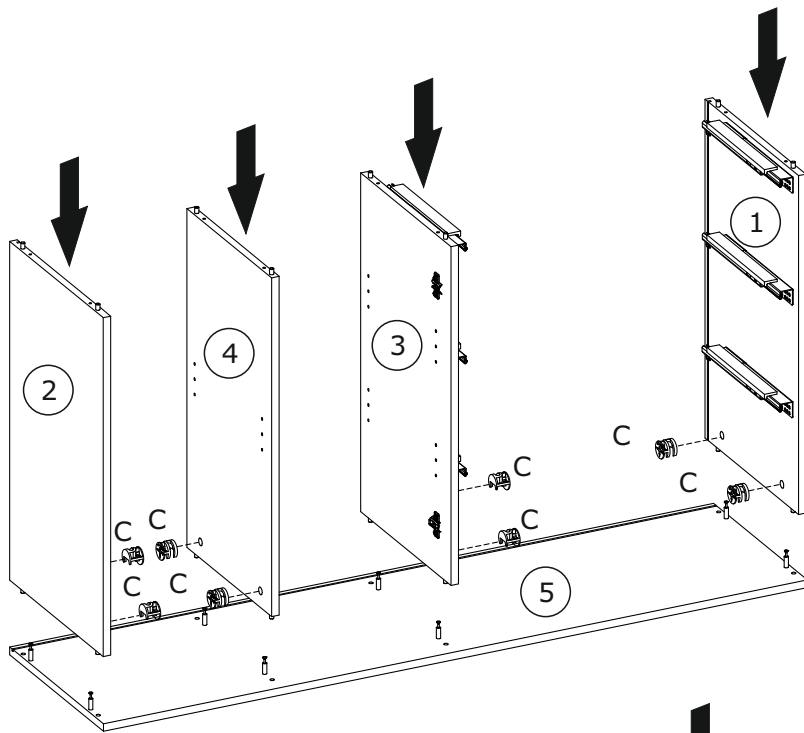

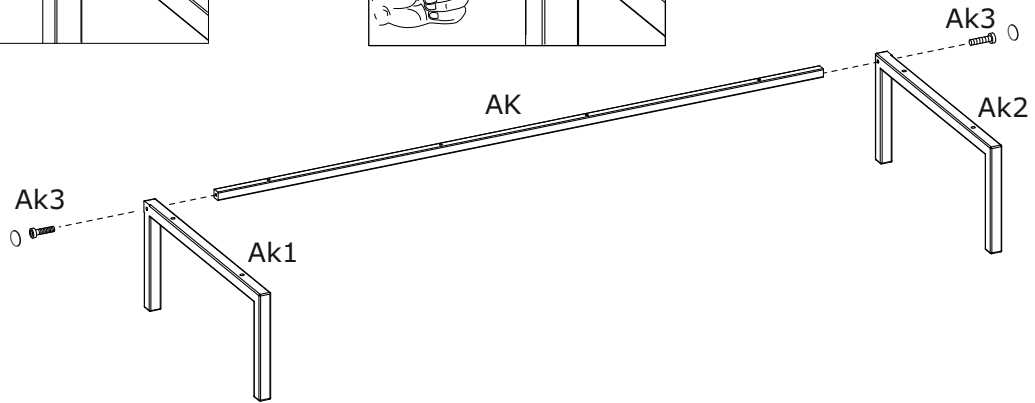
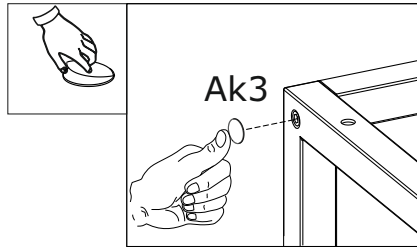
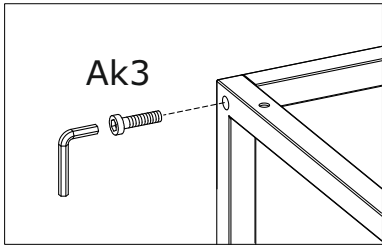
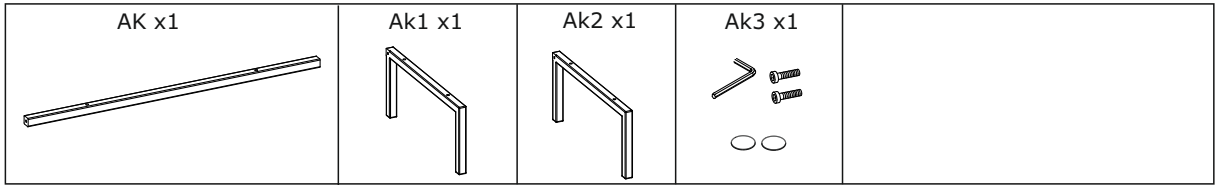

C
Ø15x12 mm

C1
Ø15x10 mm



5

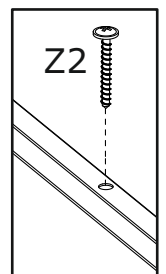
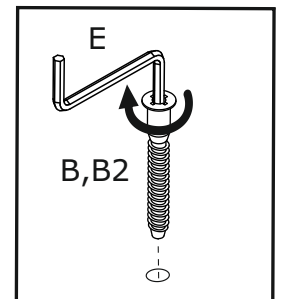
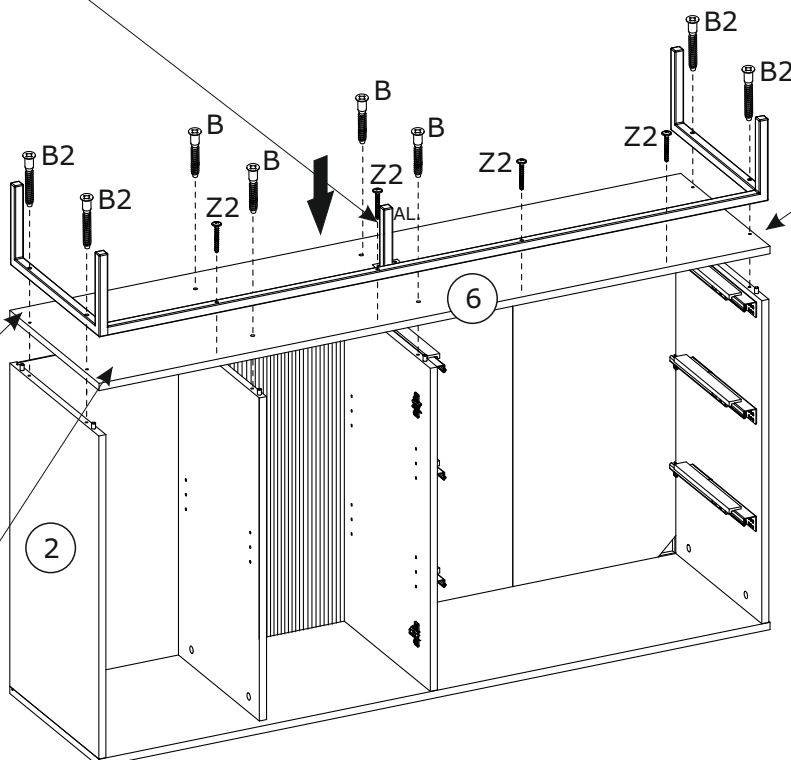
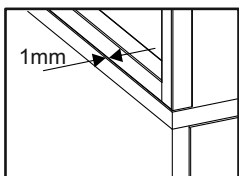
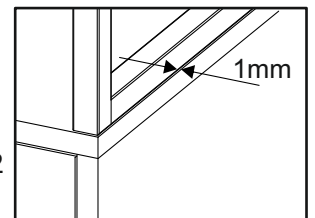
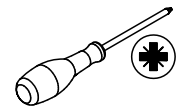
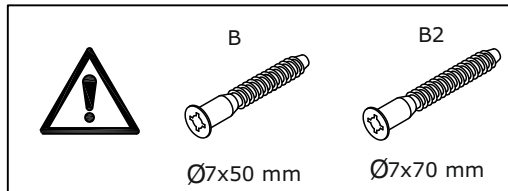
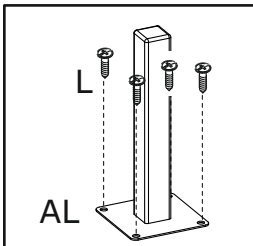
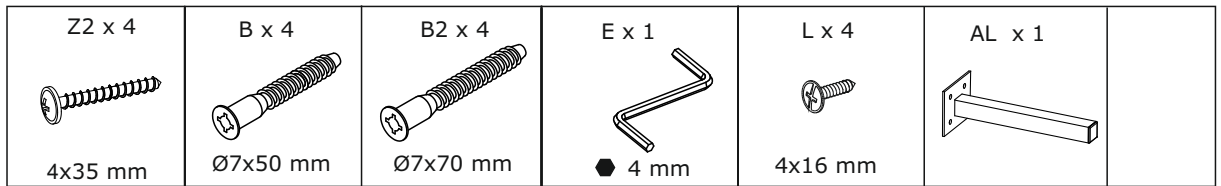

6



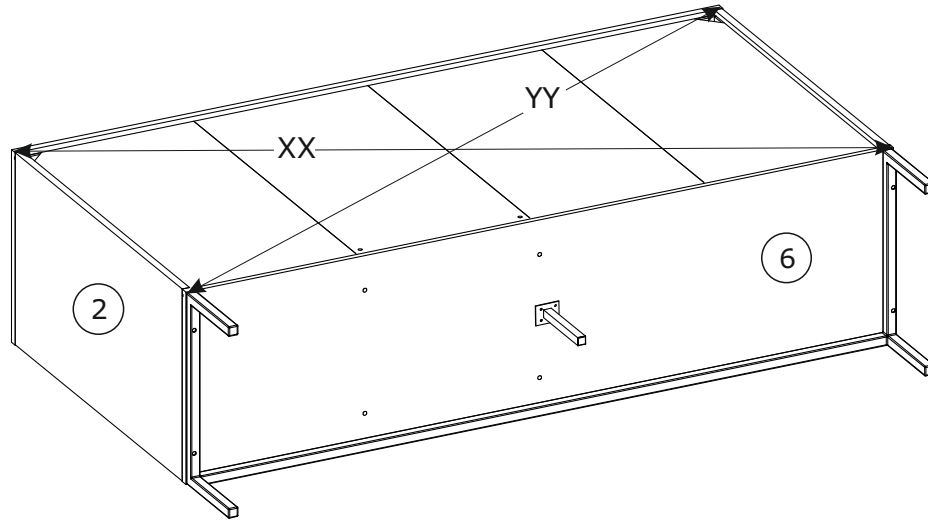

7

 $XX=YY\equiv 90^\circ$

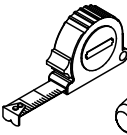
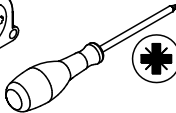

8

H x 10  22x9x2 mm	G2 x 12  10x10 mm	L1 x 10  Ø3x20 mm	 
--	--	--	---

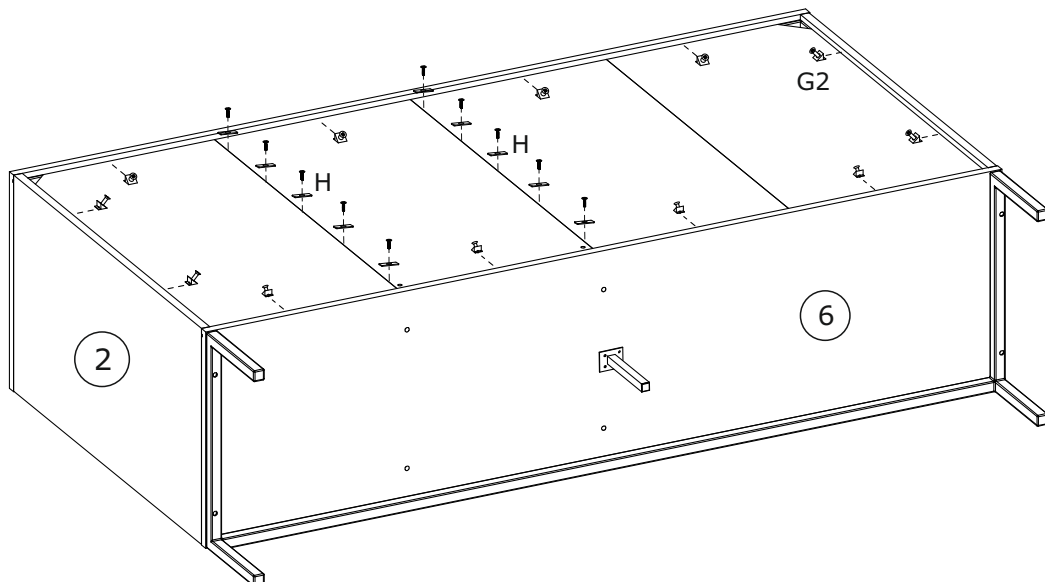
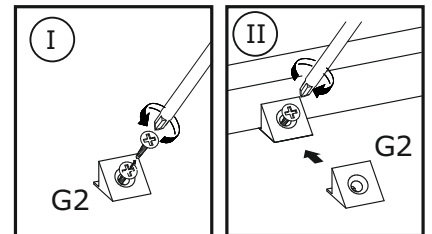
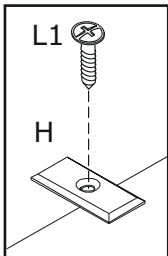

9

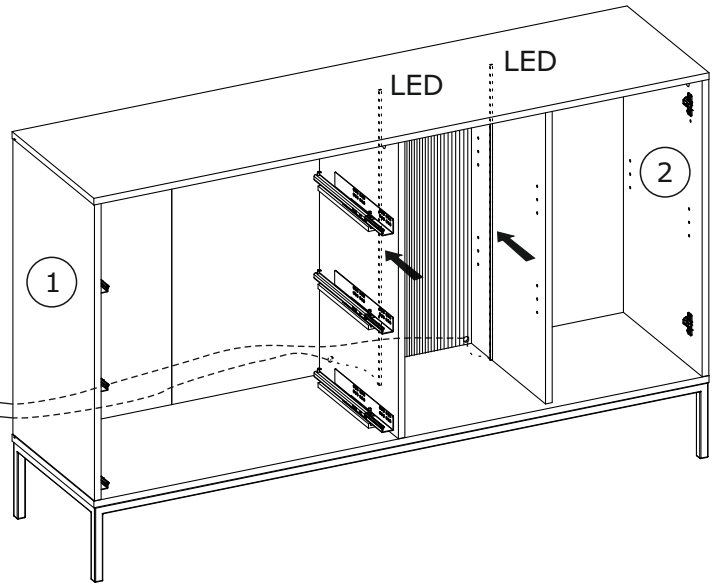
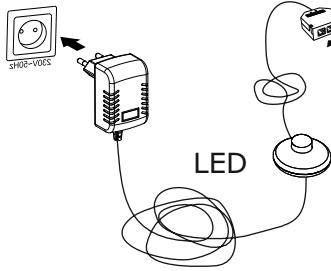
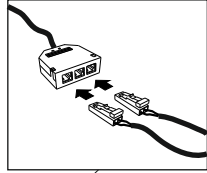
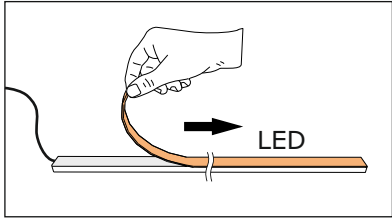

10

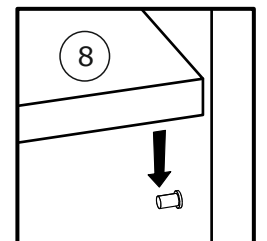
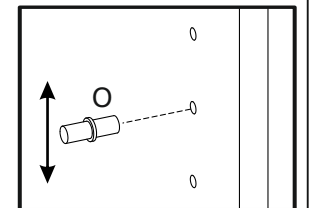
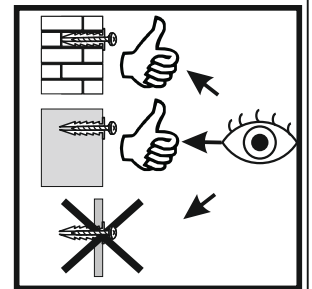
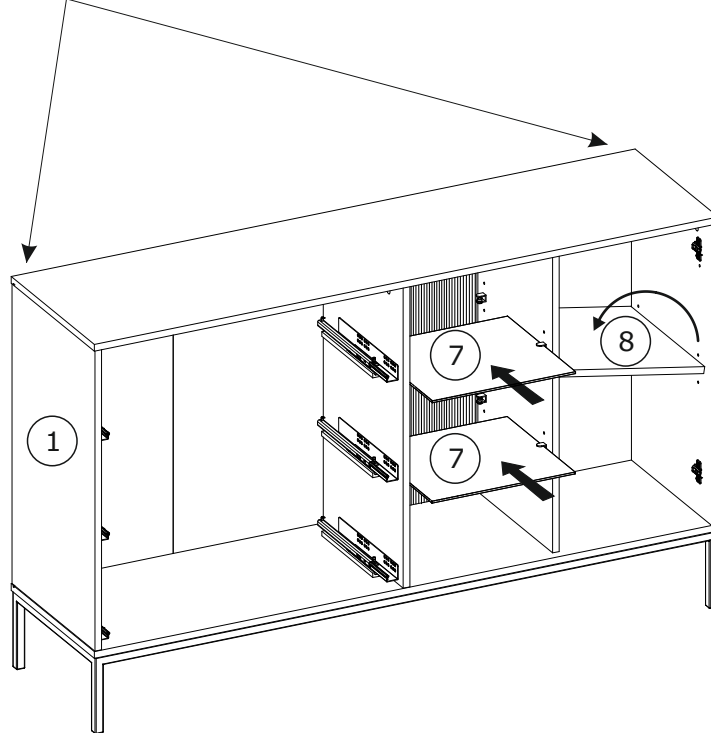
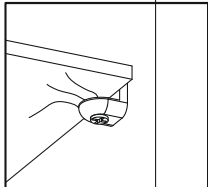
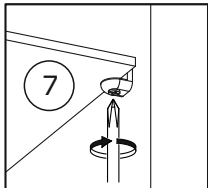
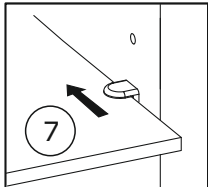
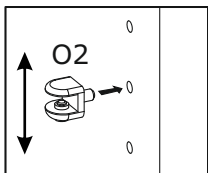
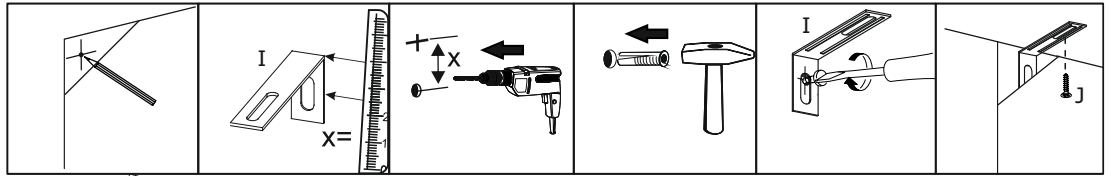
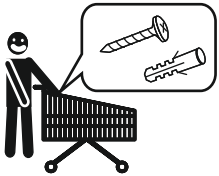
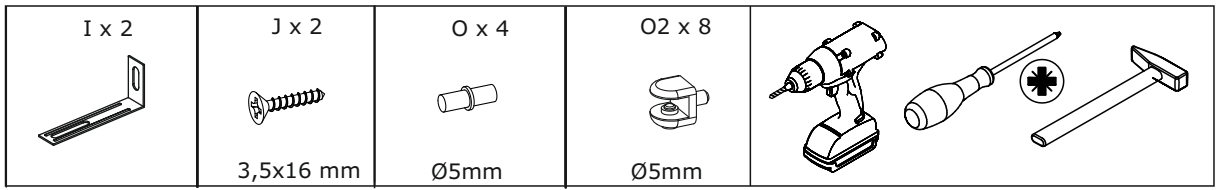

11

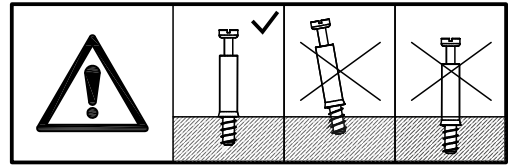
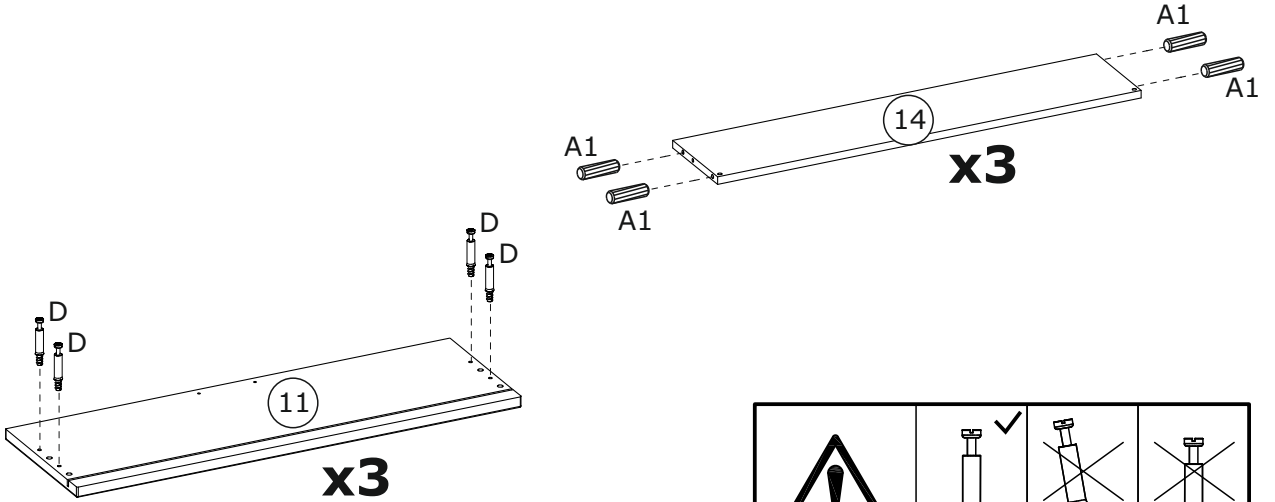

12

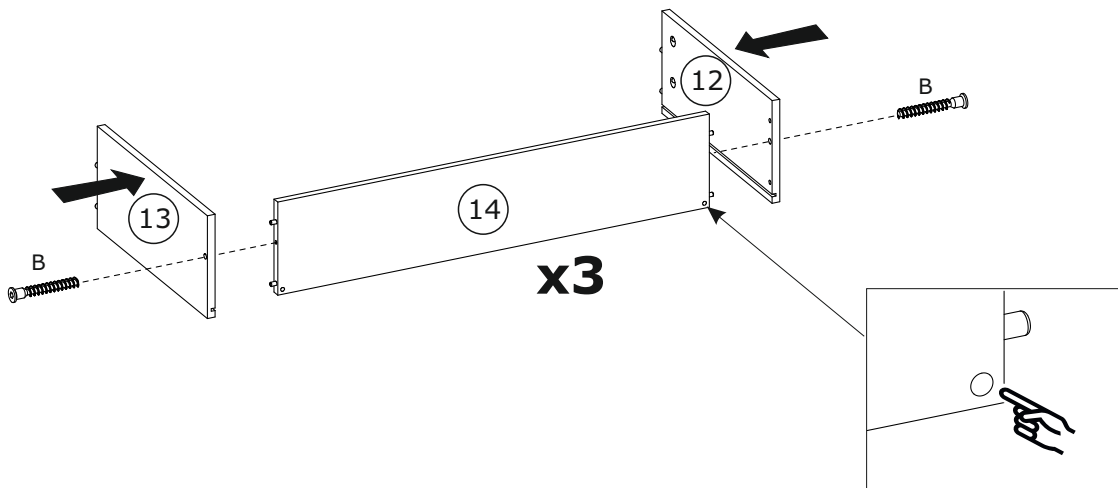
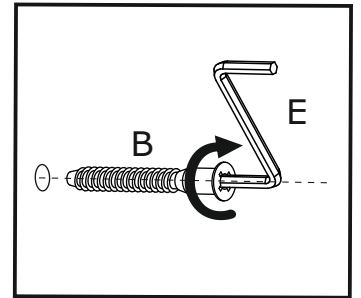
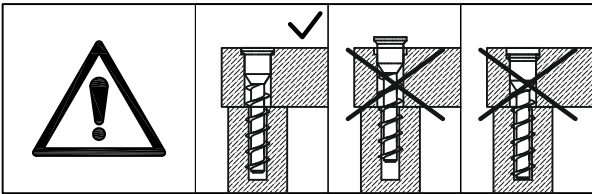

13

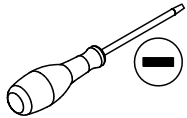
C1 x 12  Ø15x10 mm	F1 x 12  20 mm	
---	---	---

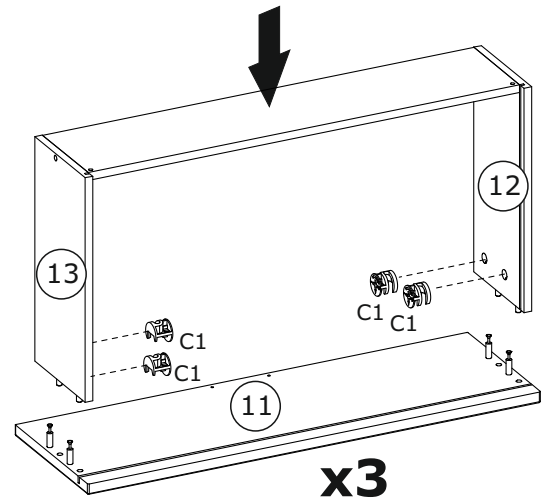
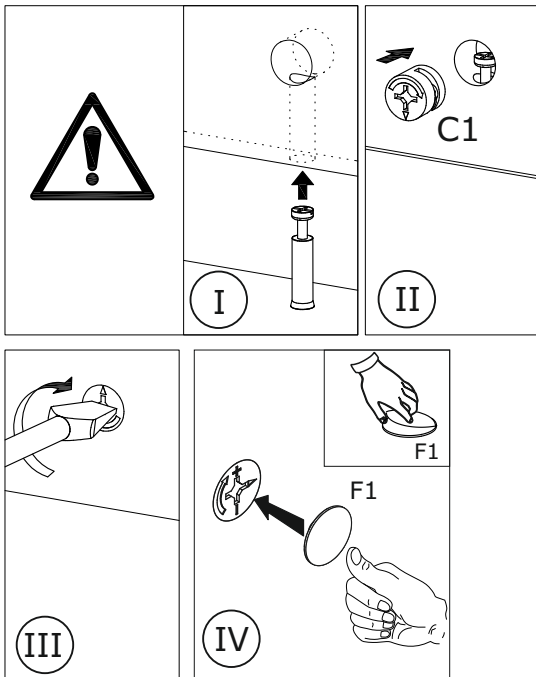

14

L1 x 15  Ø3x20 mm	G2 x 6  10x10 mm	 
--	---	---

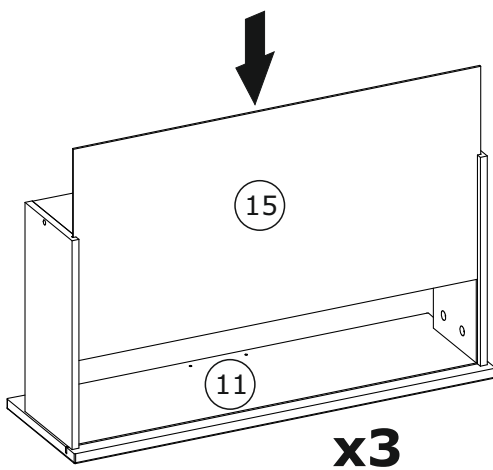

 $XX = YY \equiv 90^\circ$

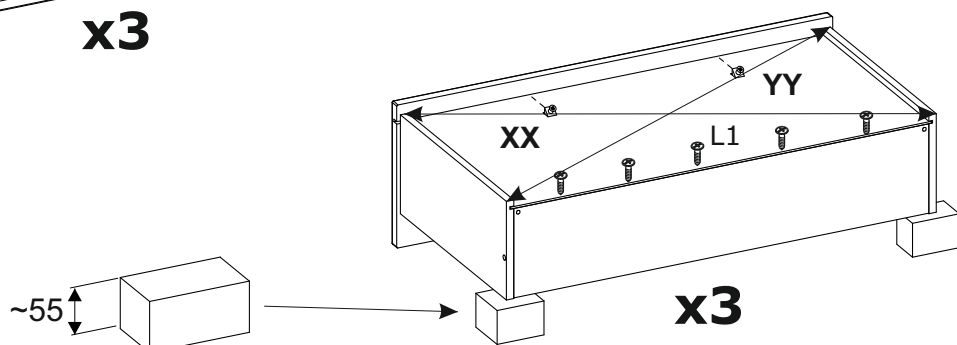
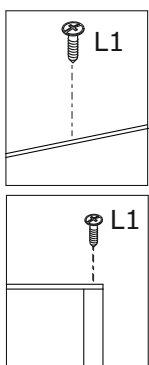
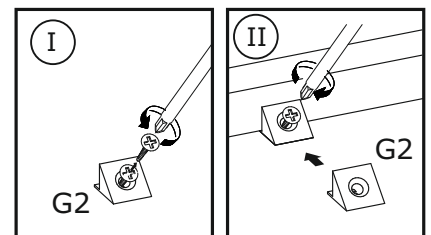

15

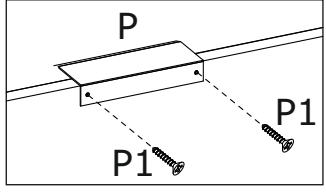
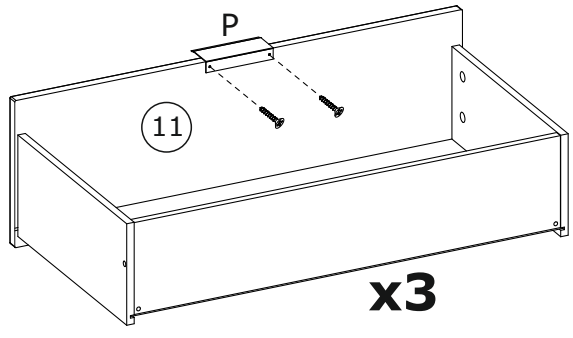
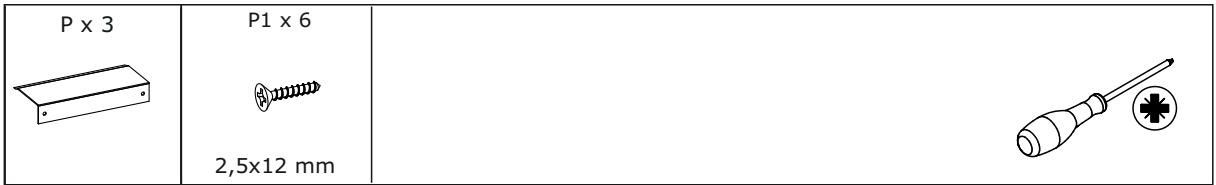

16

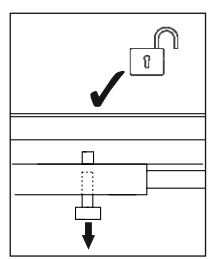
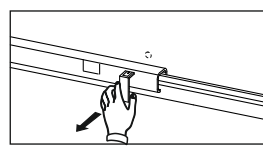
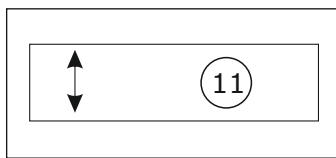
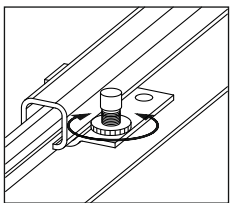
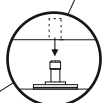
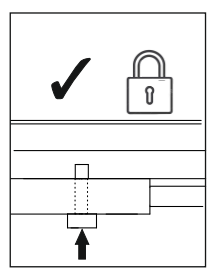
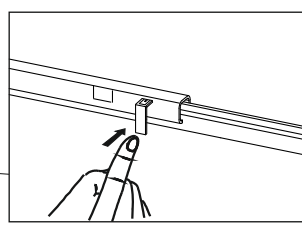
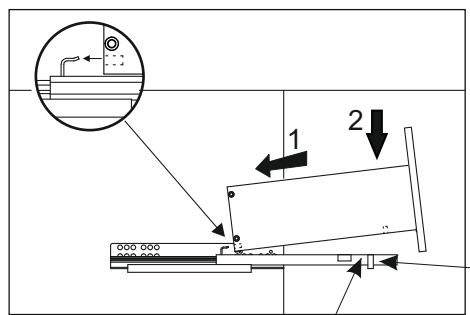
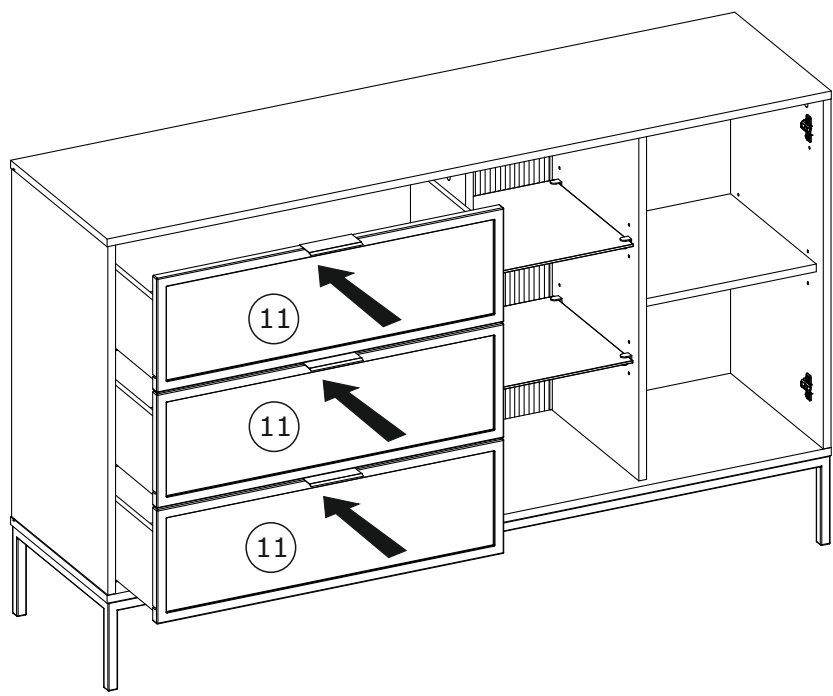

17

R6 x 2 	J1 x 4 3,5x13 mm 	S x 2 	
---	--	--	---

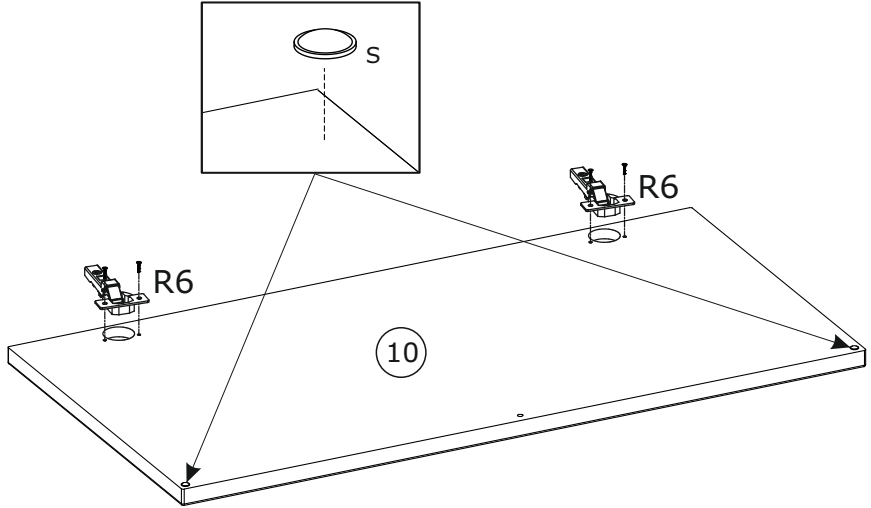
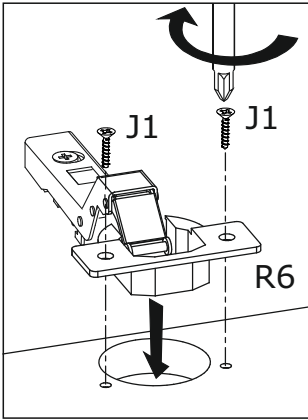

18

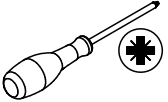
R10 x 2 	
--	---

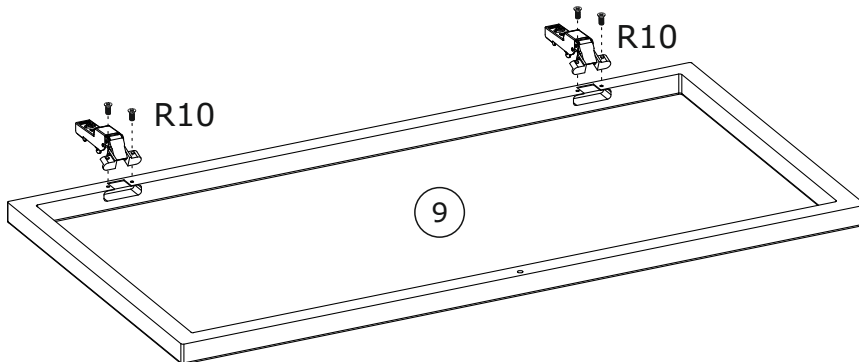
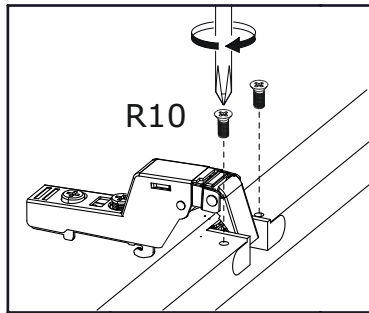
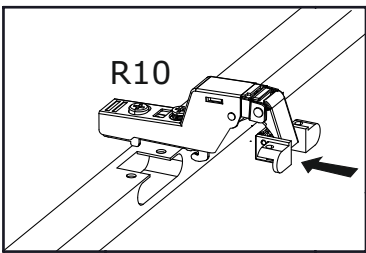

19

P2 x 2 	P3 x 1 	P4 x 1 	
---	---	---	---

