

360 min

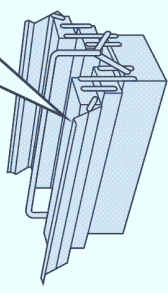

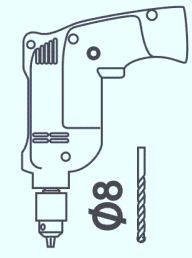

A

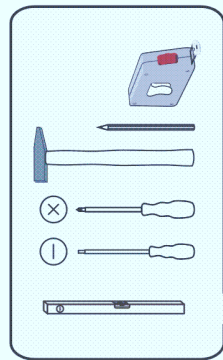
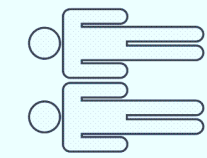
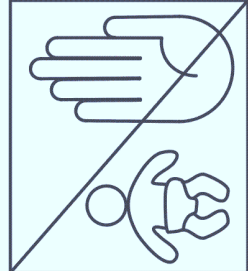
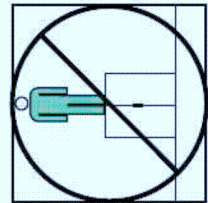
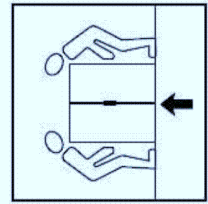
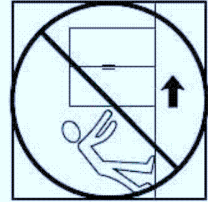
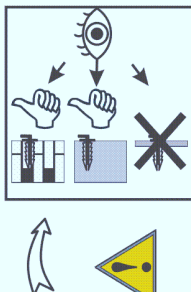
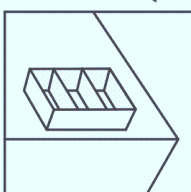
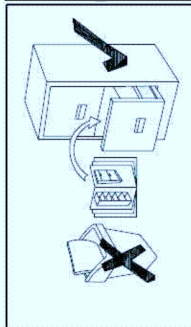
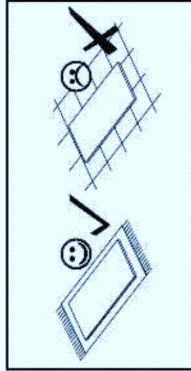
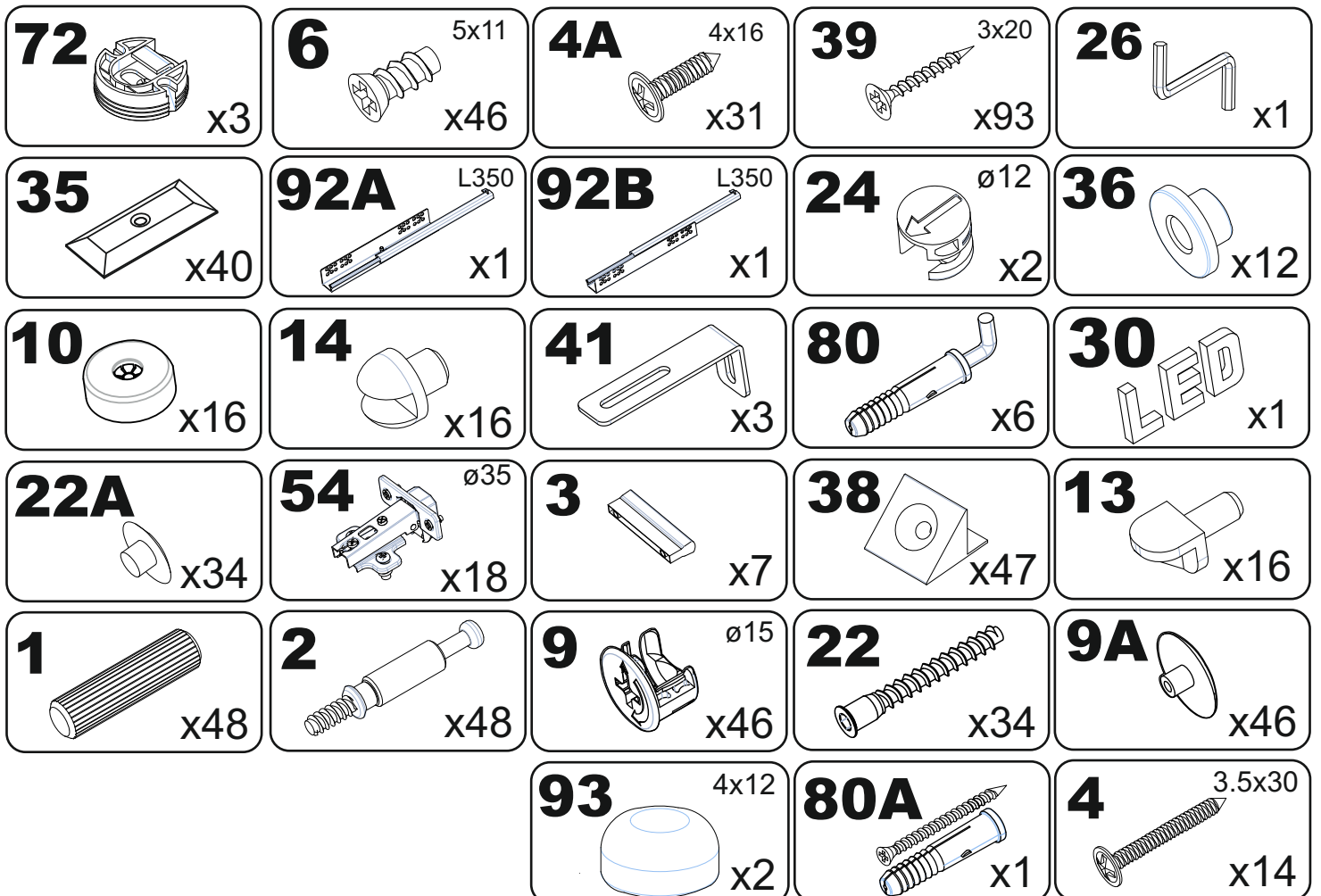
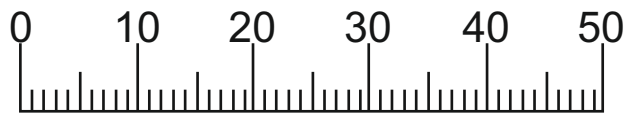
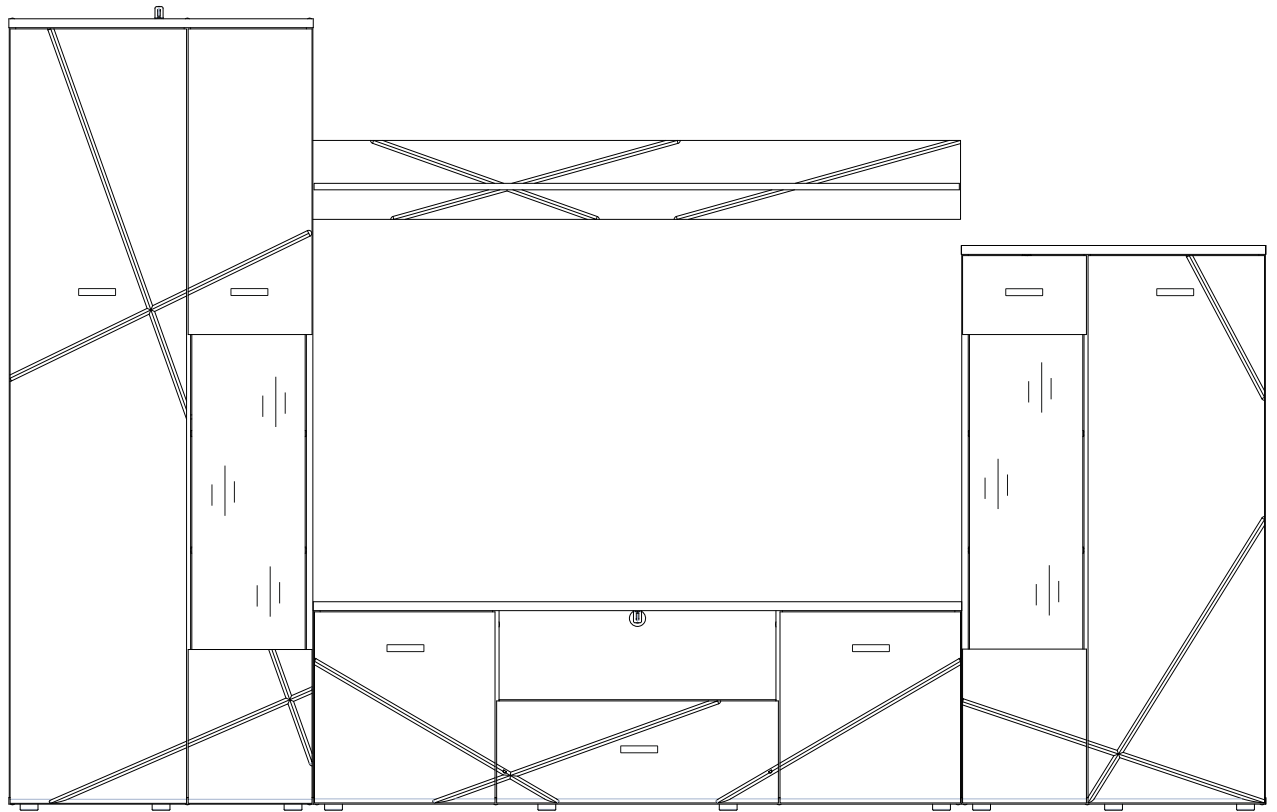
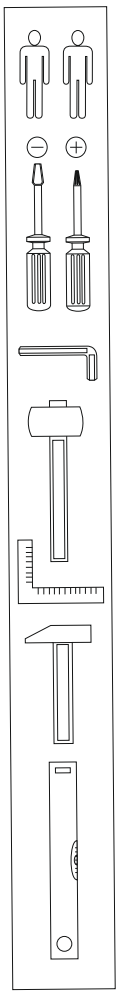
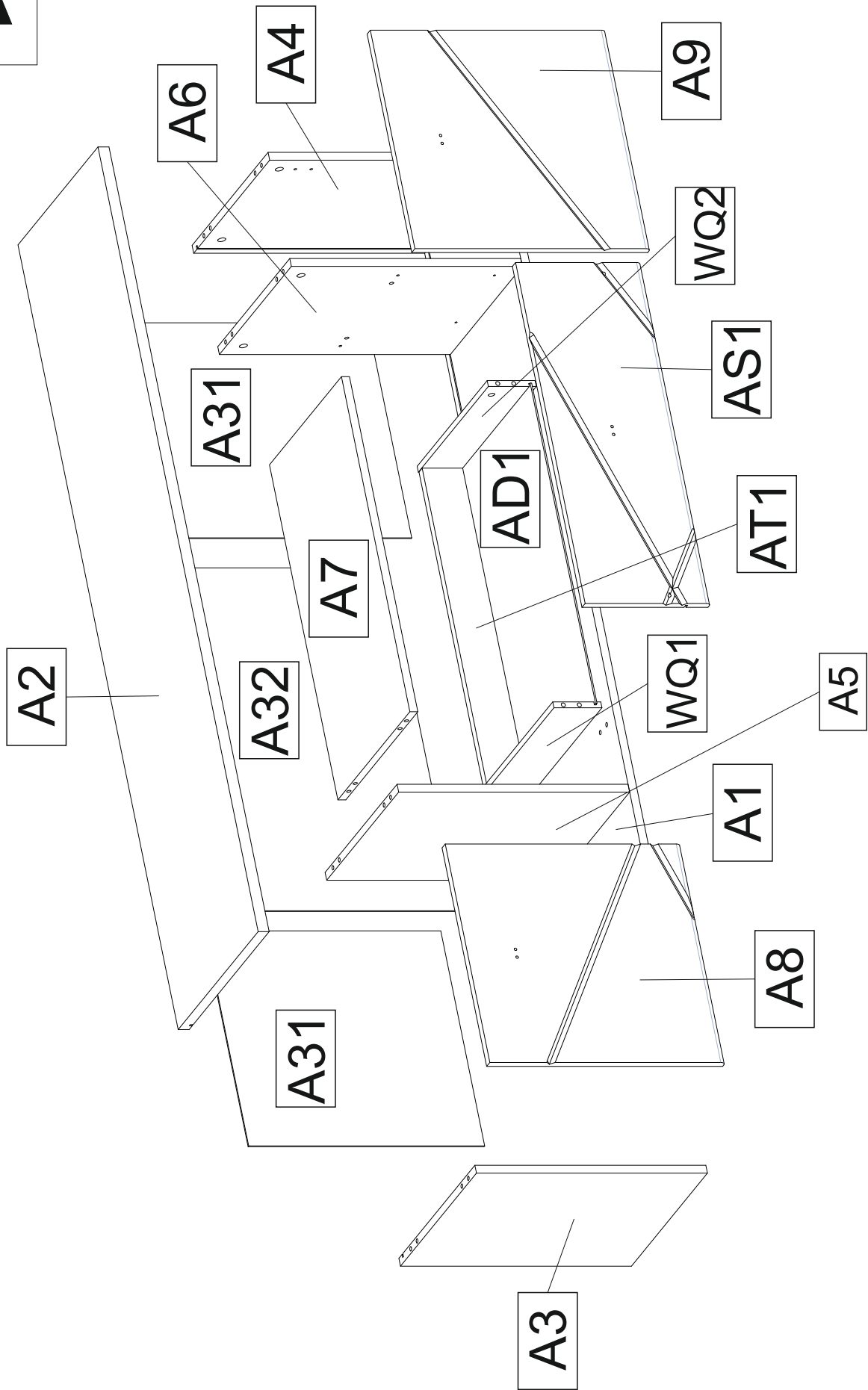

1

2

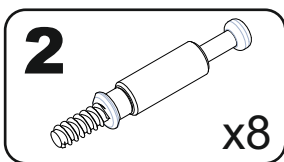

x8

A2

1602x400

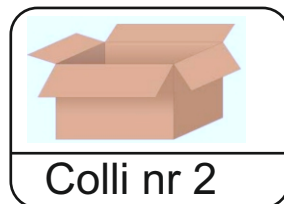

Colli nr 2

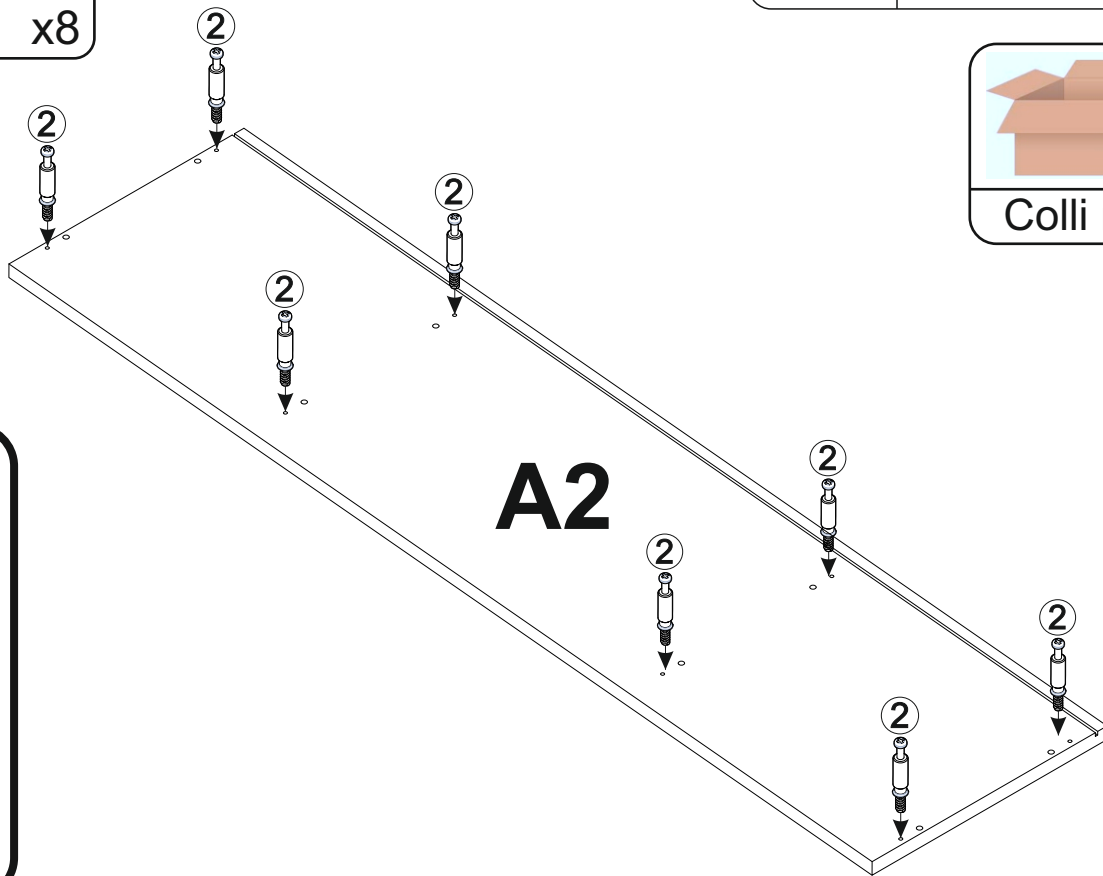

A2

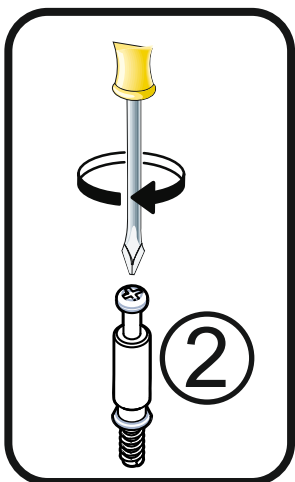

2

1

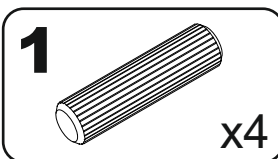

x4

9

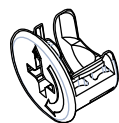

x2

ø15

54

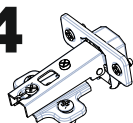

x2

ø35

A3

462x380

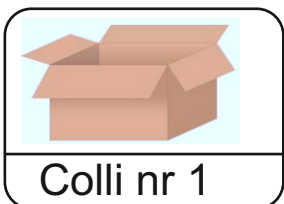

Colli nr 1

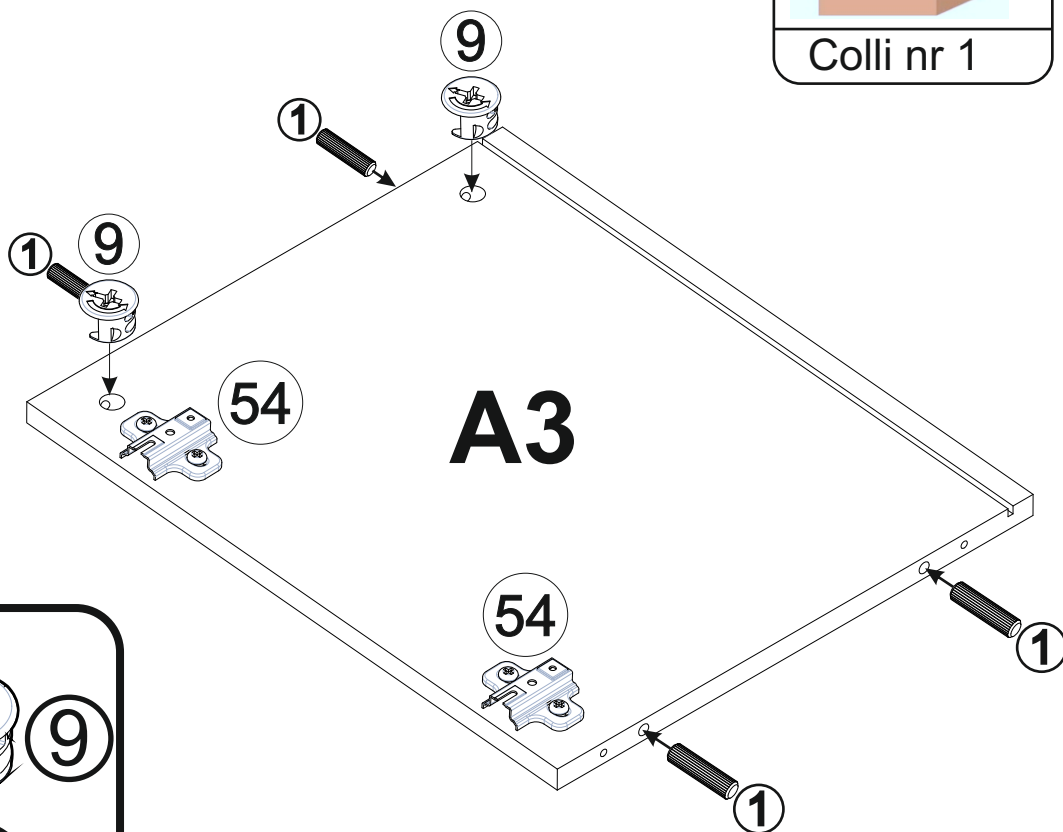
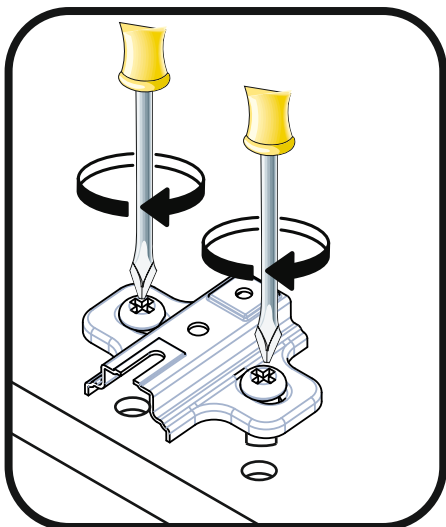

A3

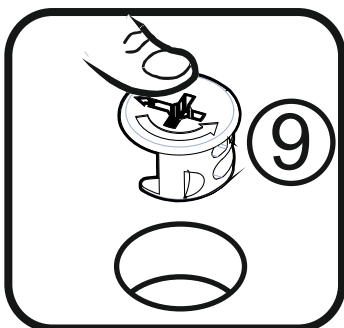

9

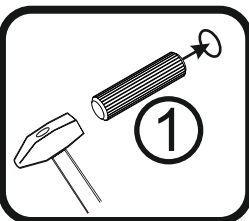

1

3

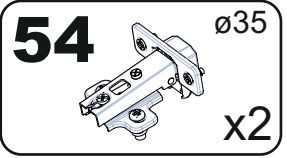
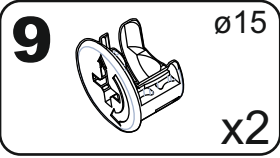
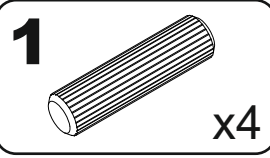

A4

462x380

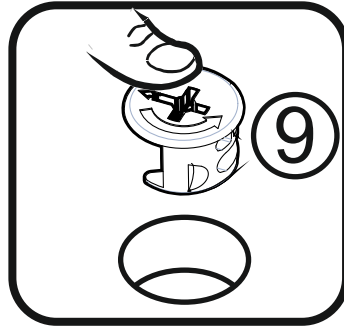
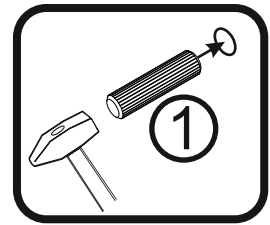
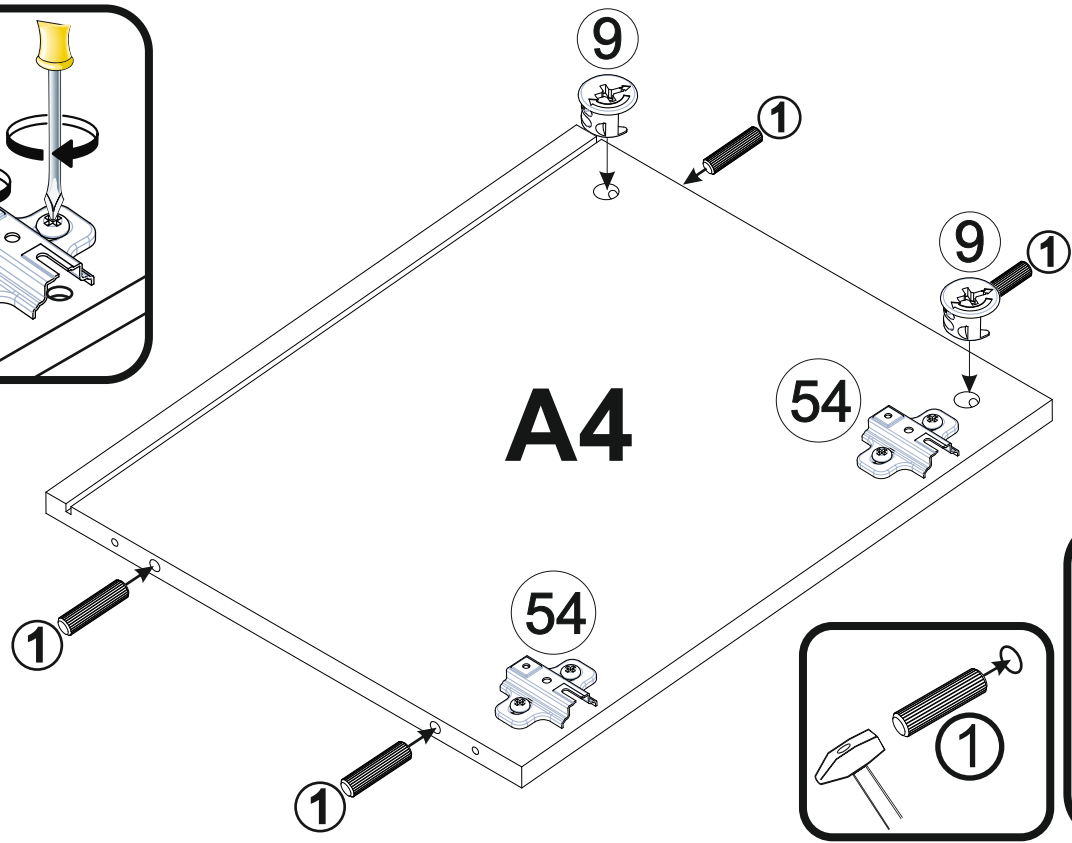
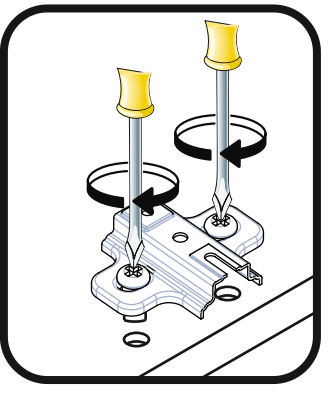
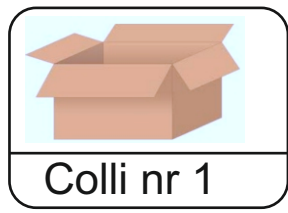

4

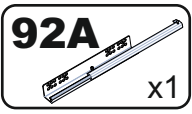
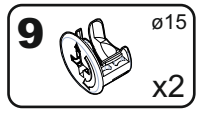
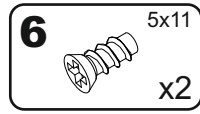
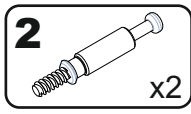
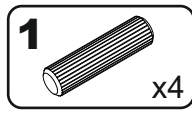

A5 462x360

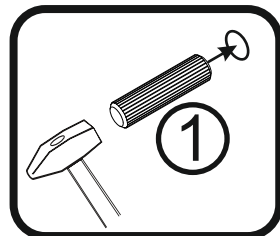
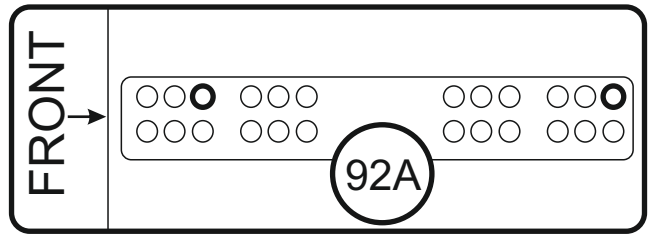
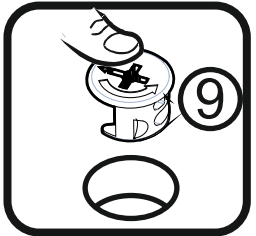
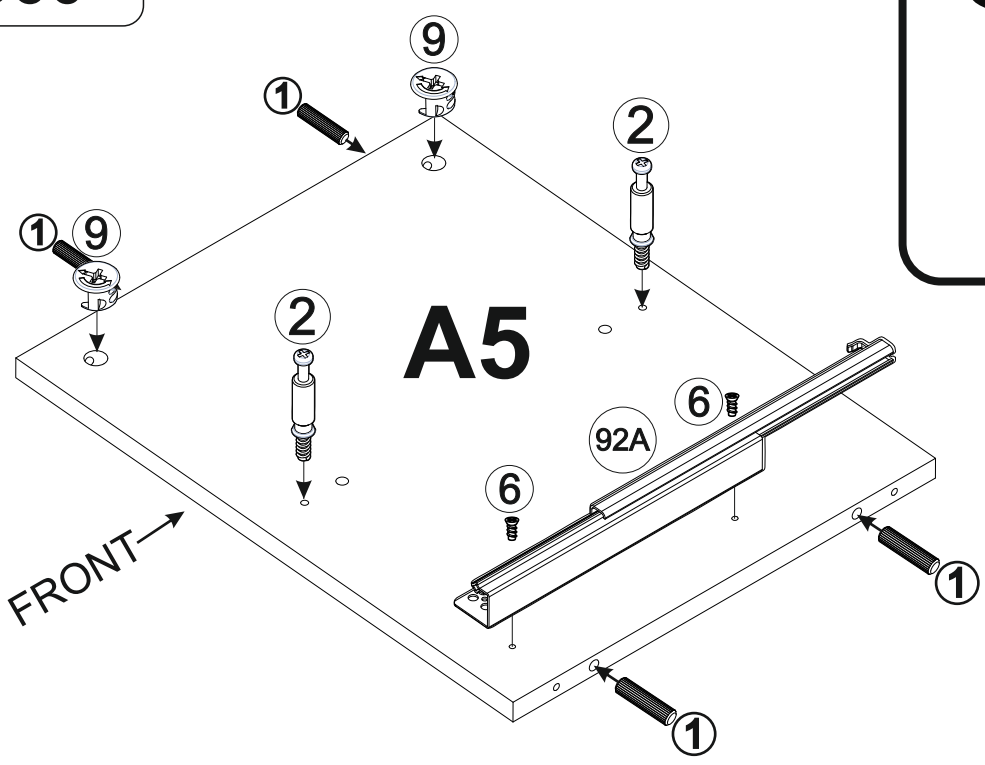
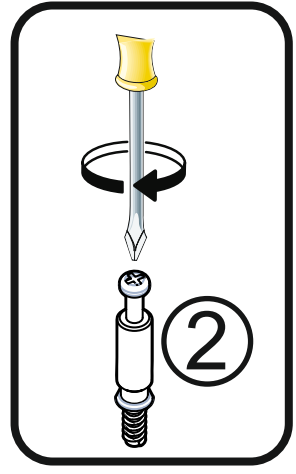
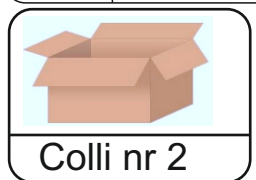

5

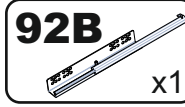
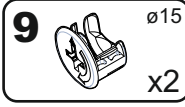
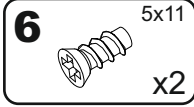
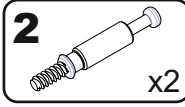
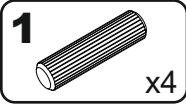

A6

462x360

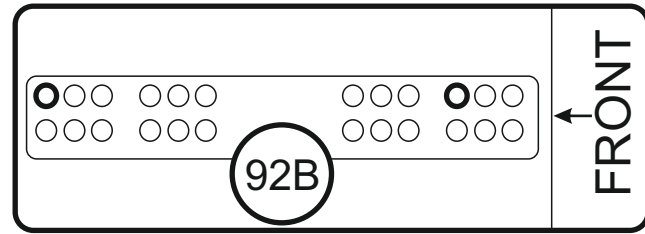
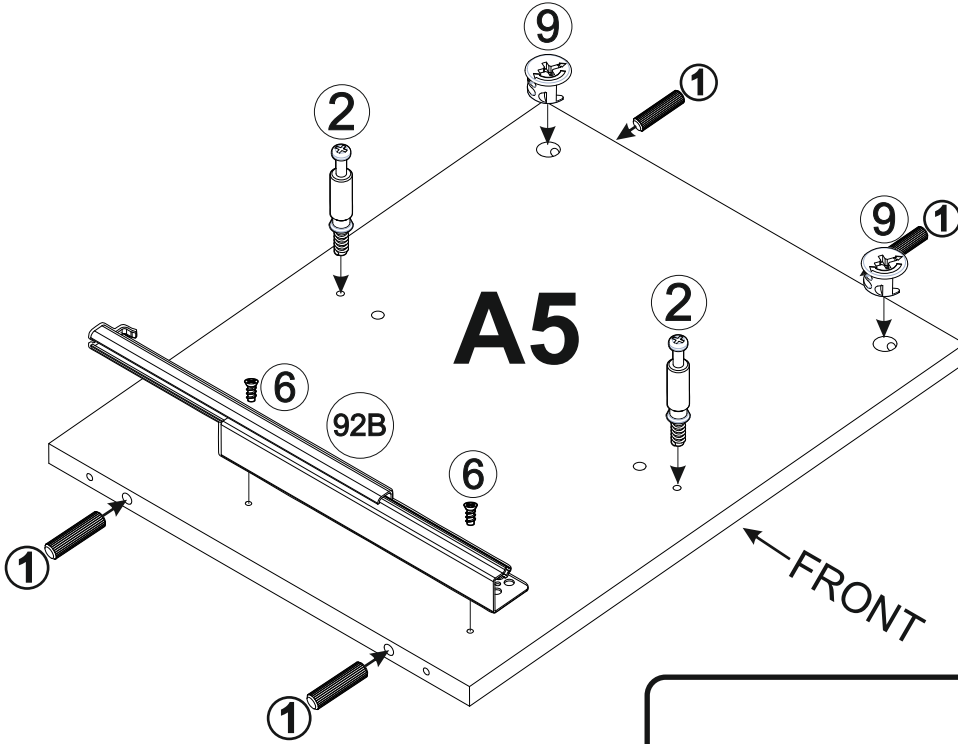
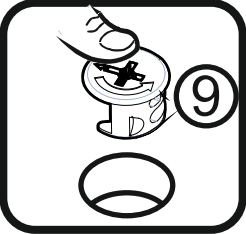
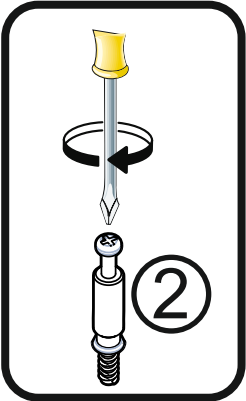
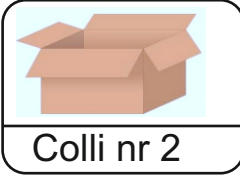

6

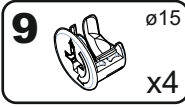
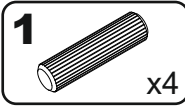

A7

684x360

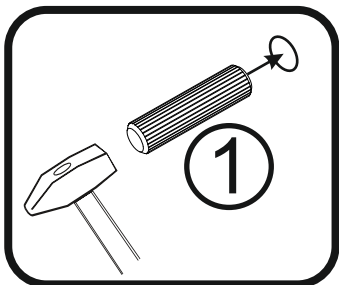
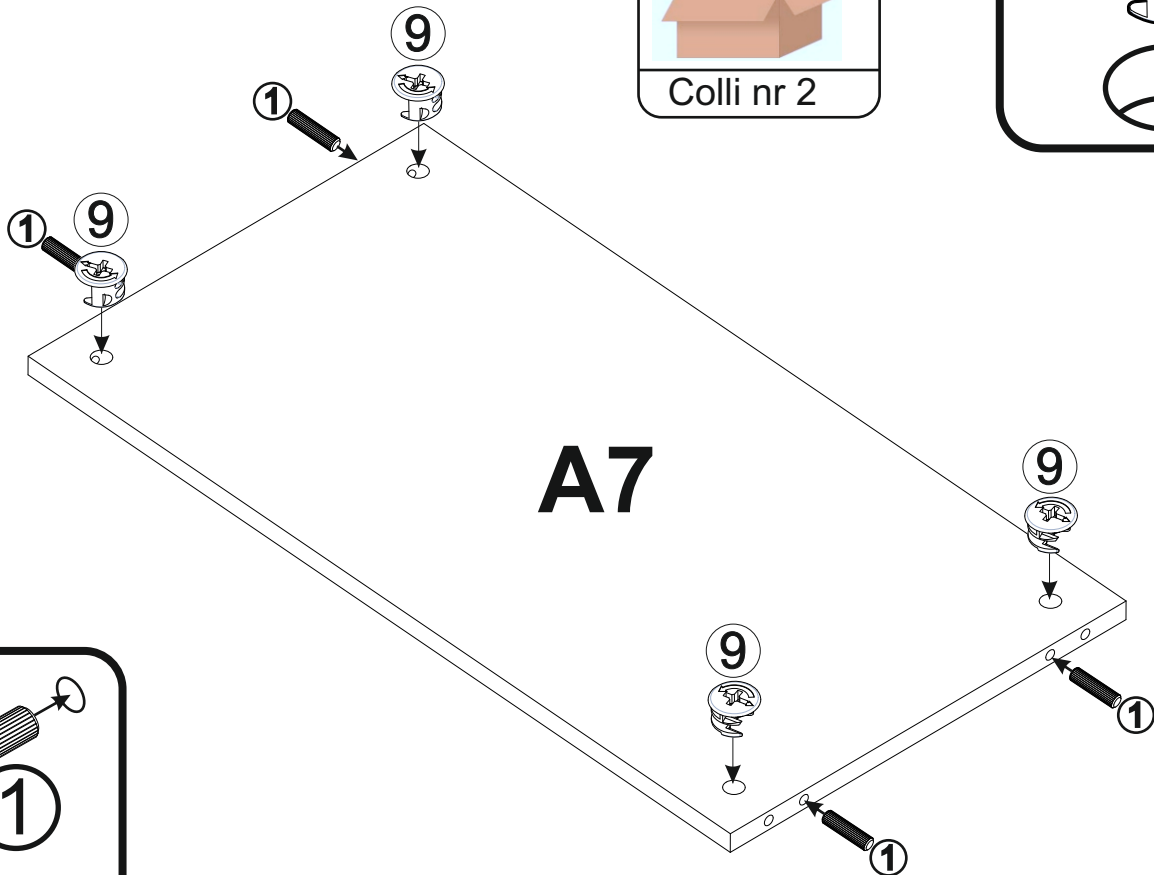
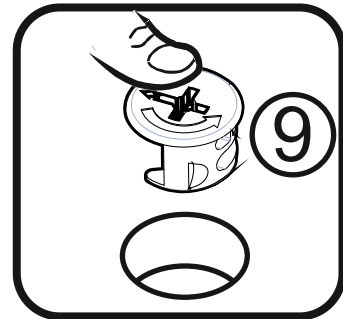
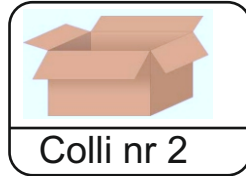

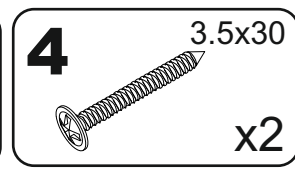
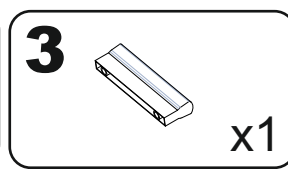
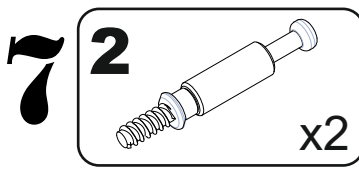

AS1 696x252

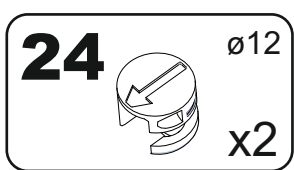
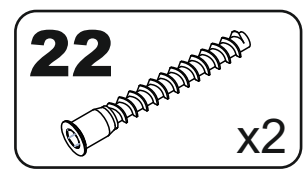
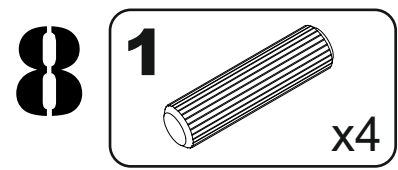
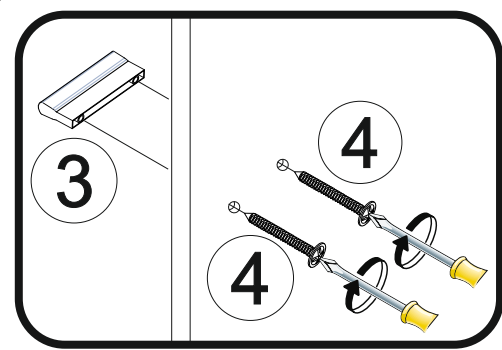
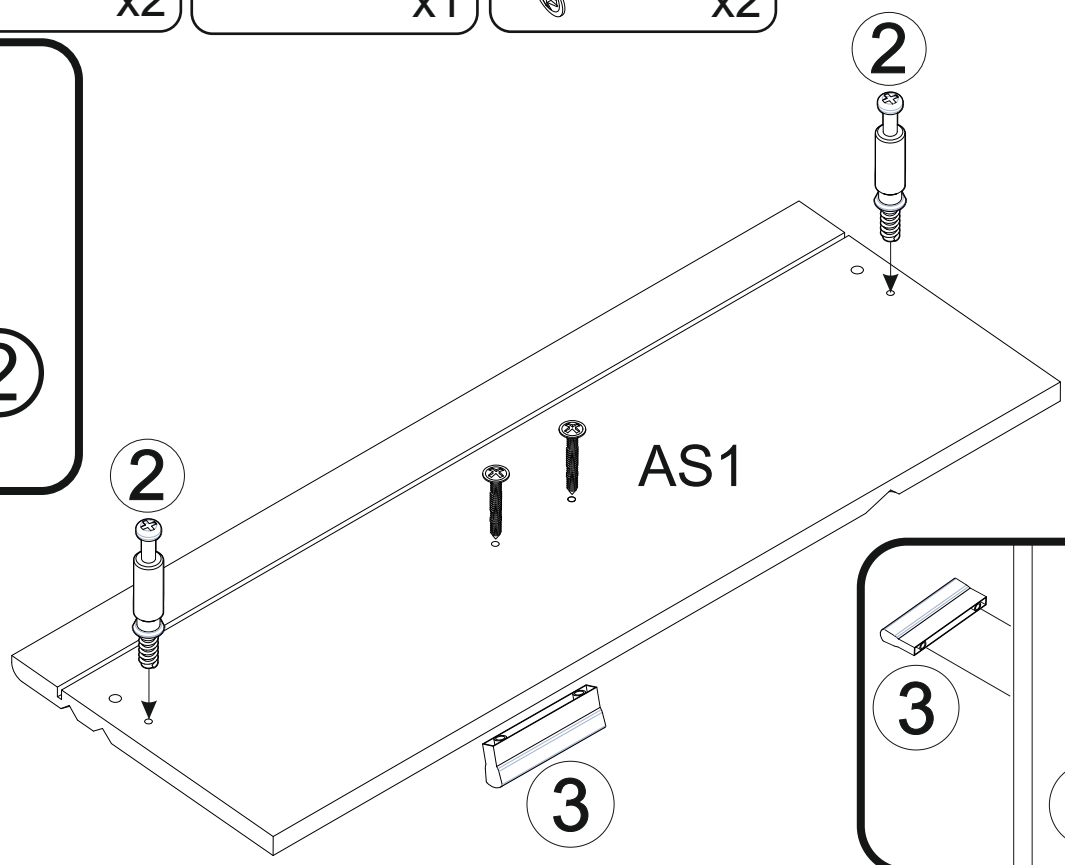
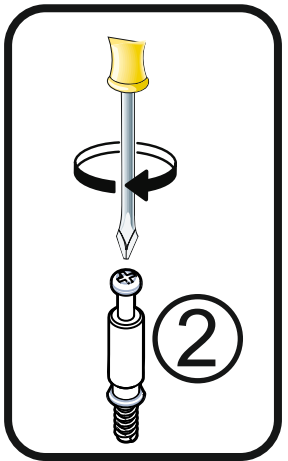
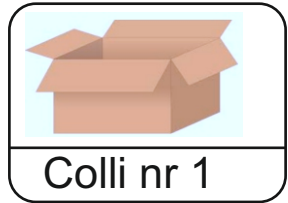

AT1 644x82

WQ1 350x96

WQ2 350x96

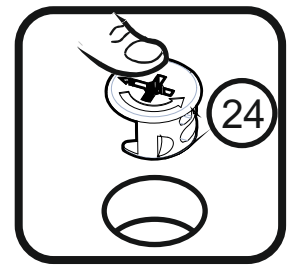
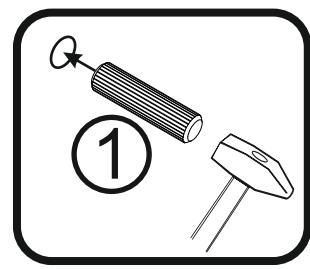
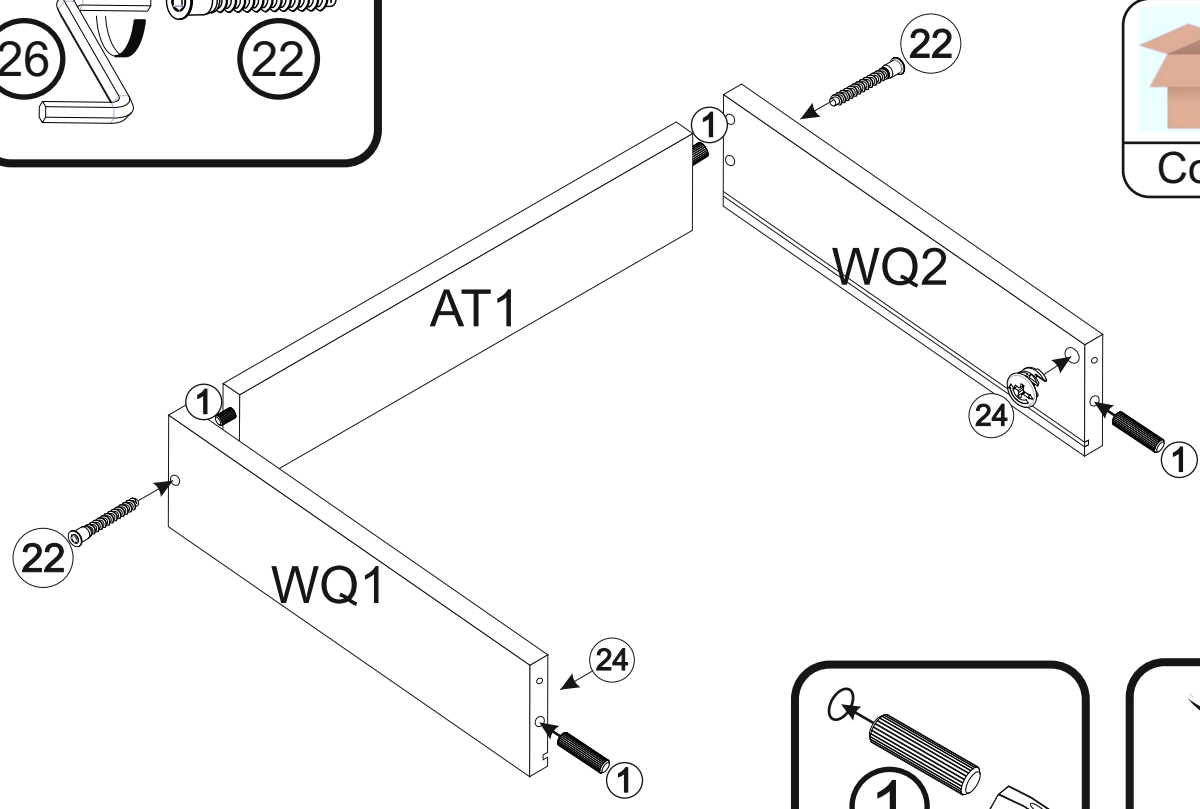
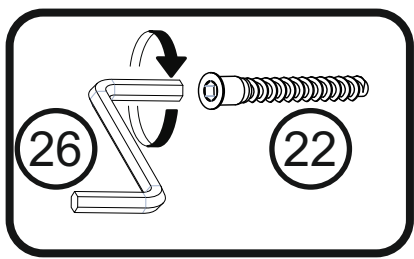
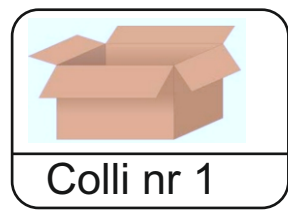

9

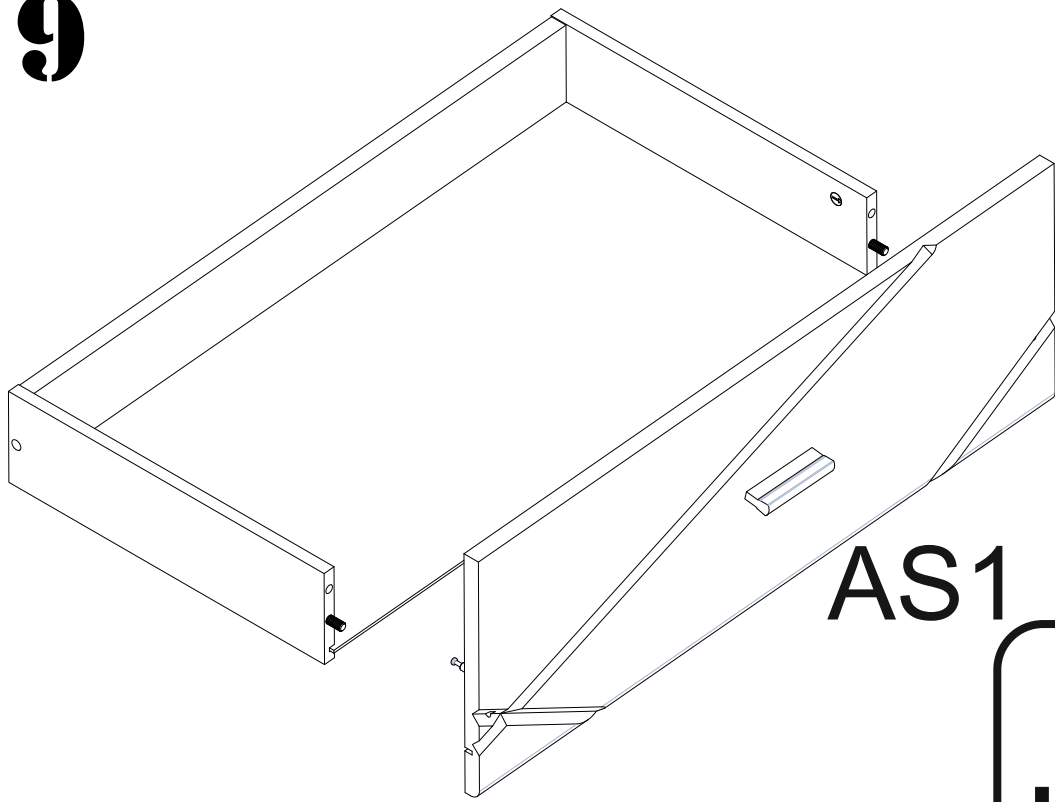

AS1

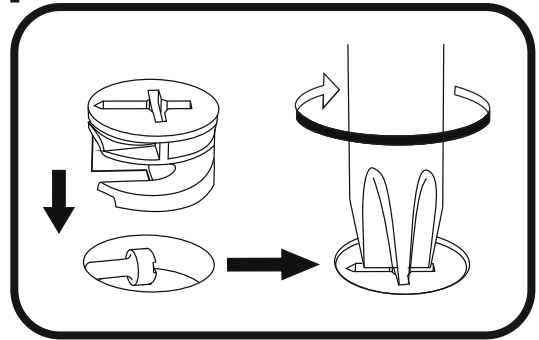

10

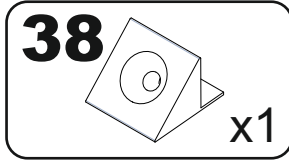
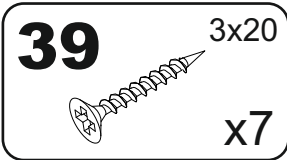

AD1 654x353

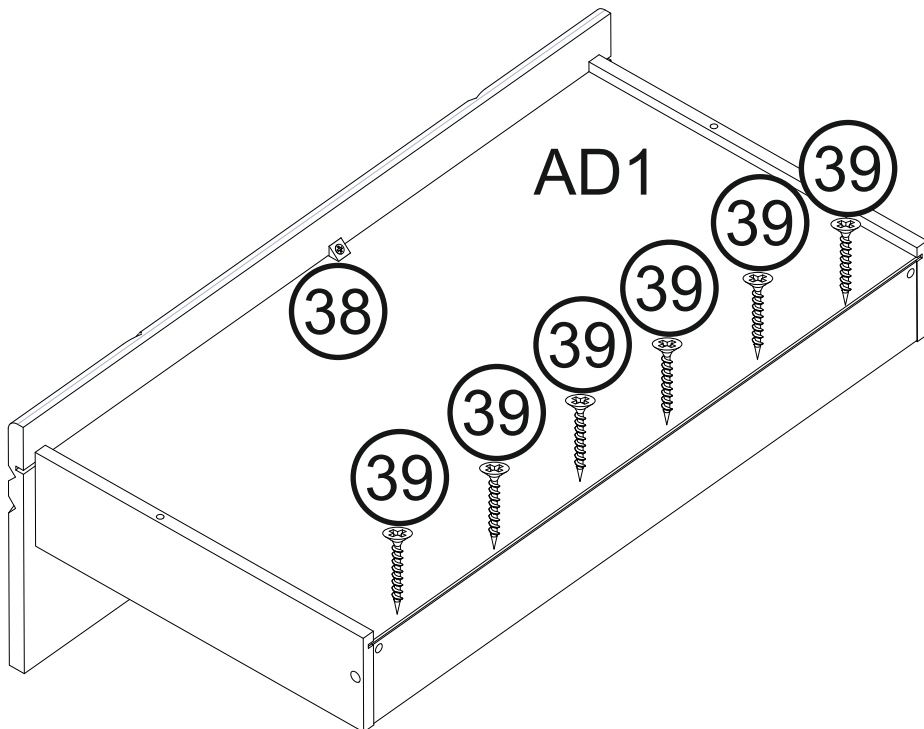
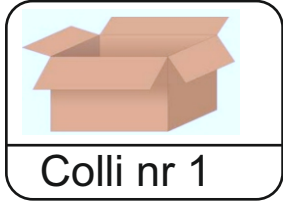

11

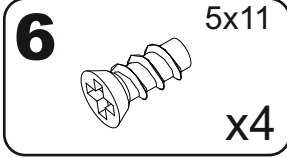
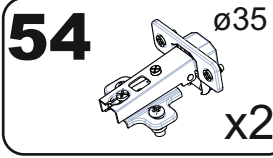

A8 446x472

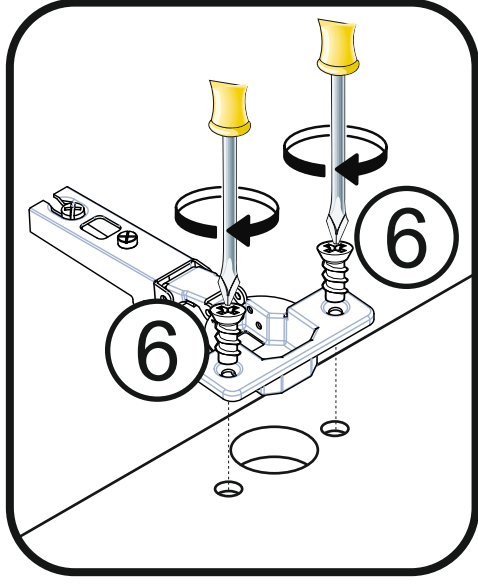
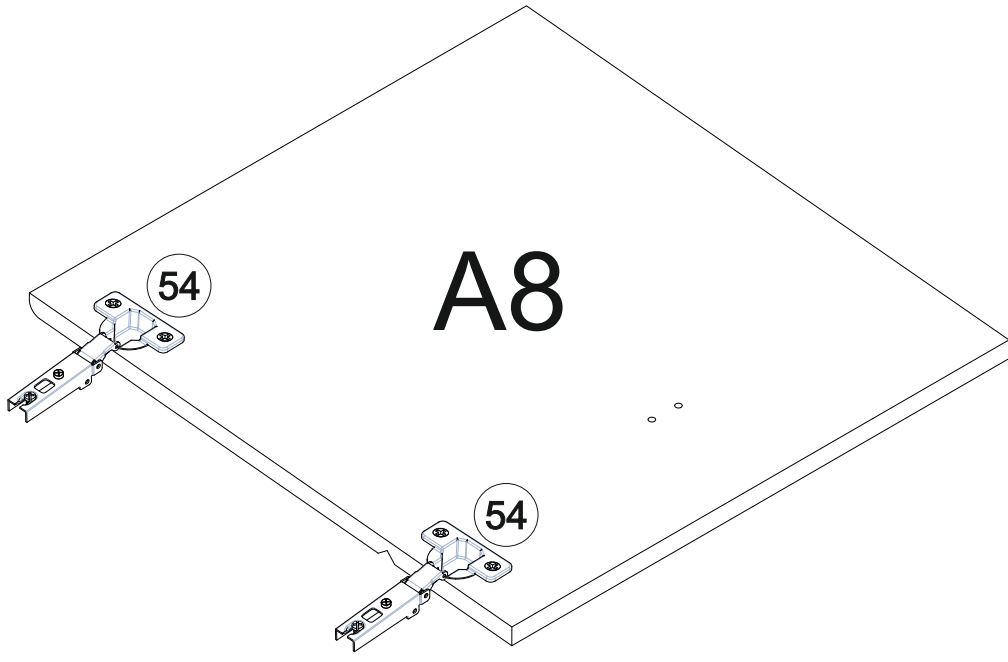
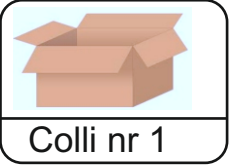

12

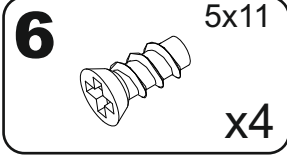
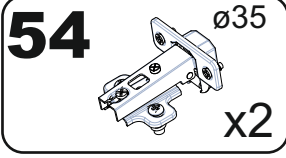

A9 446x472

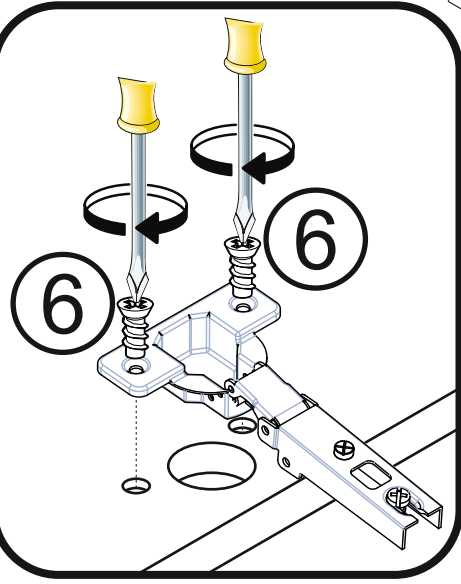
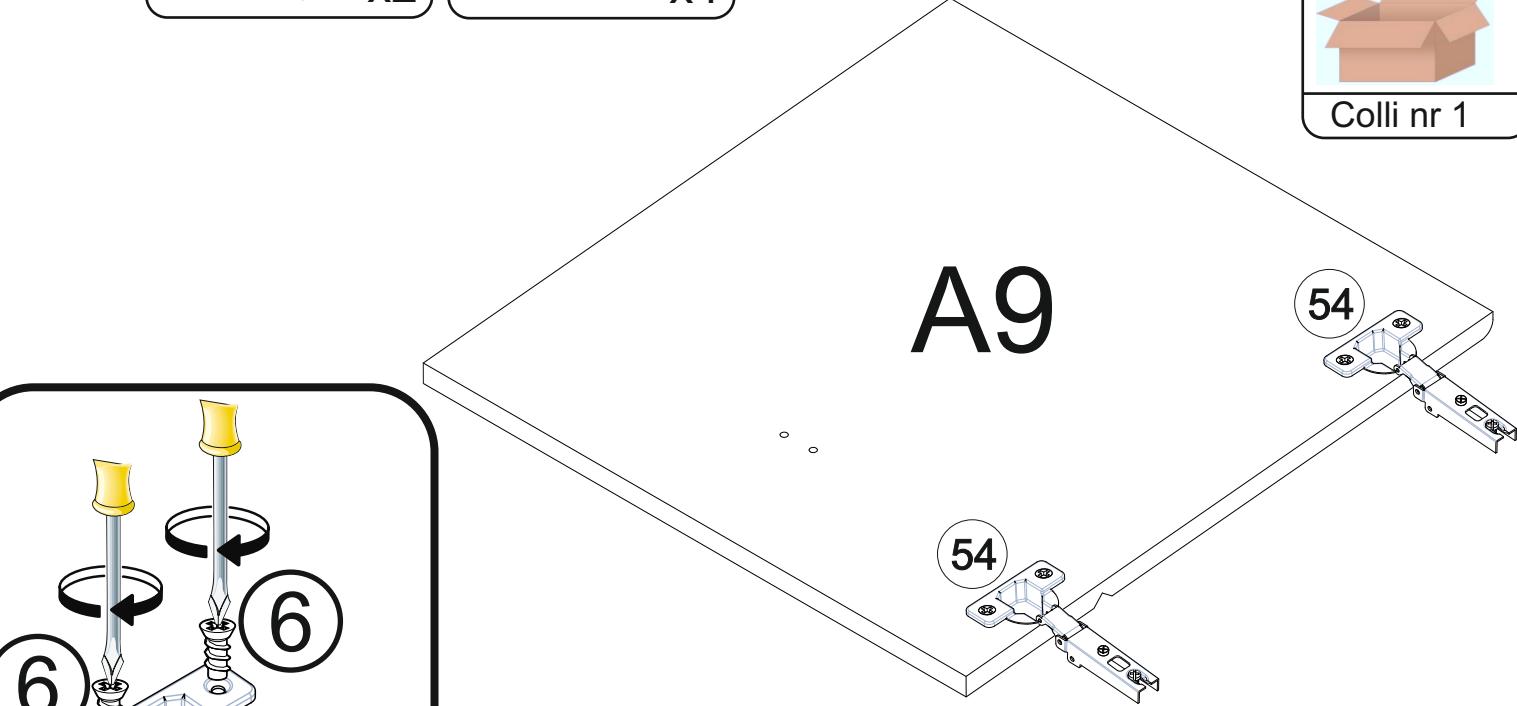
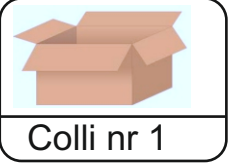

13

9A



x4

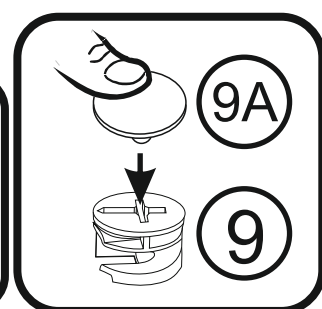
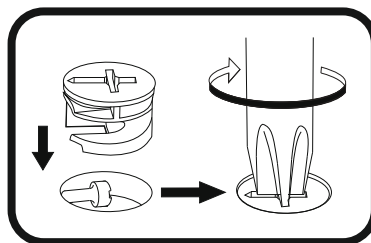
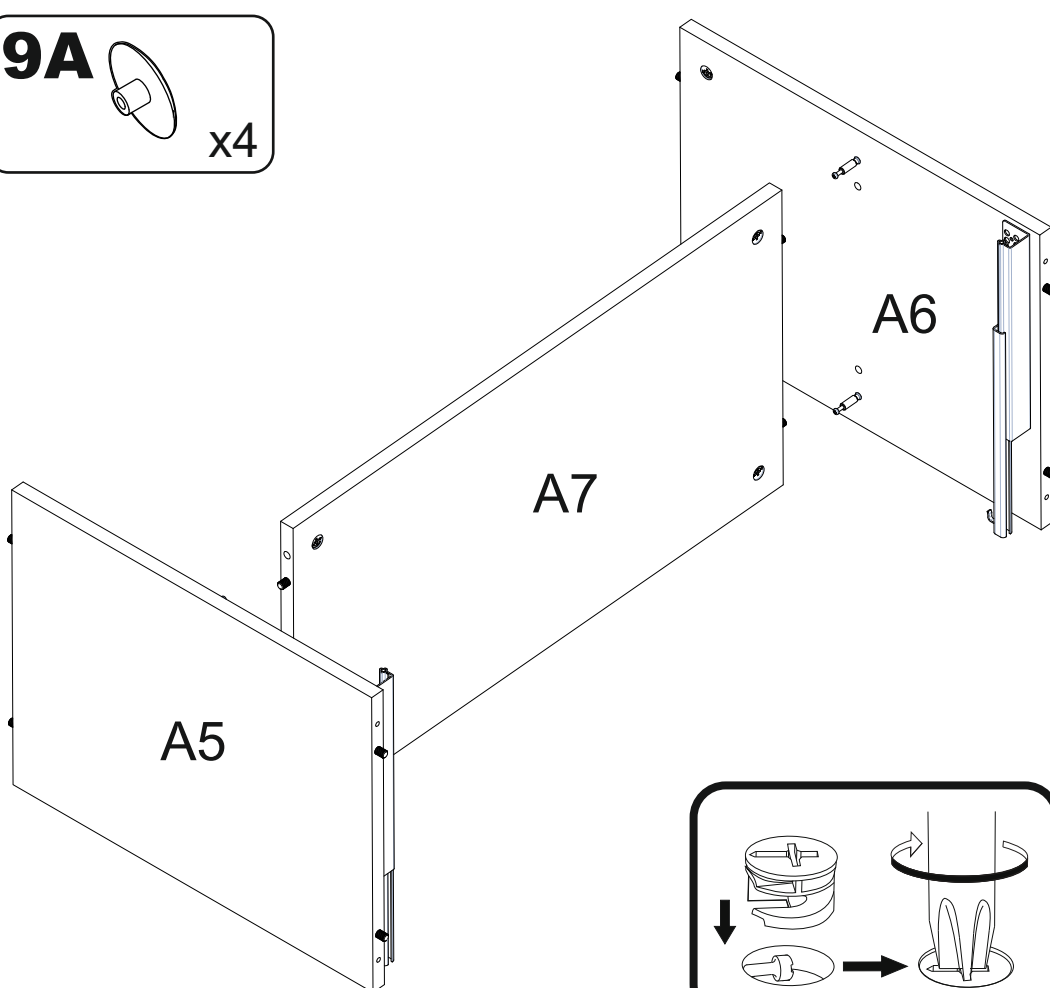

14

22



x8

22A



x8

A1

1602x380

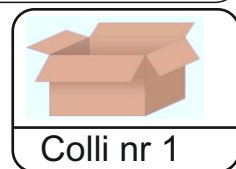
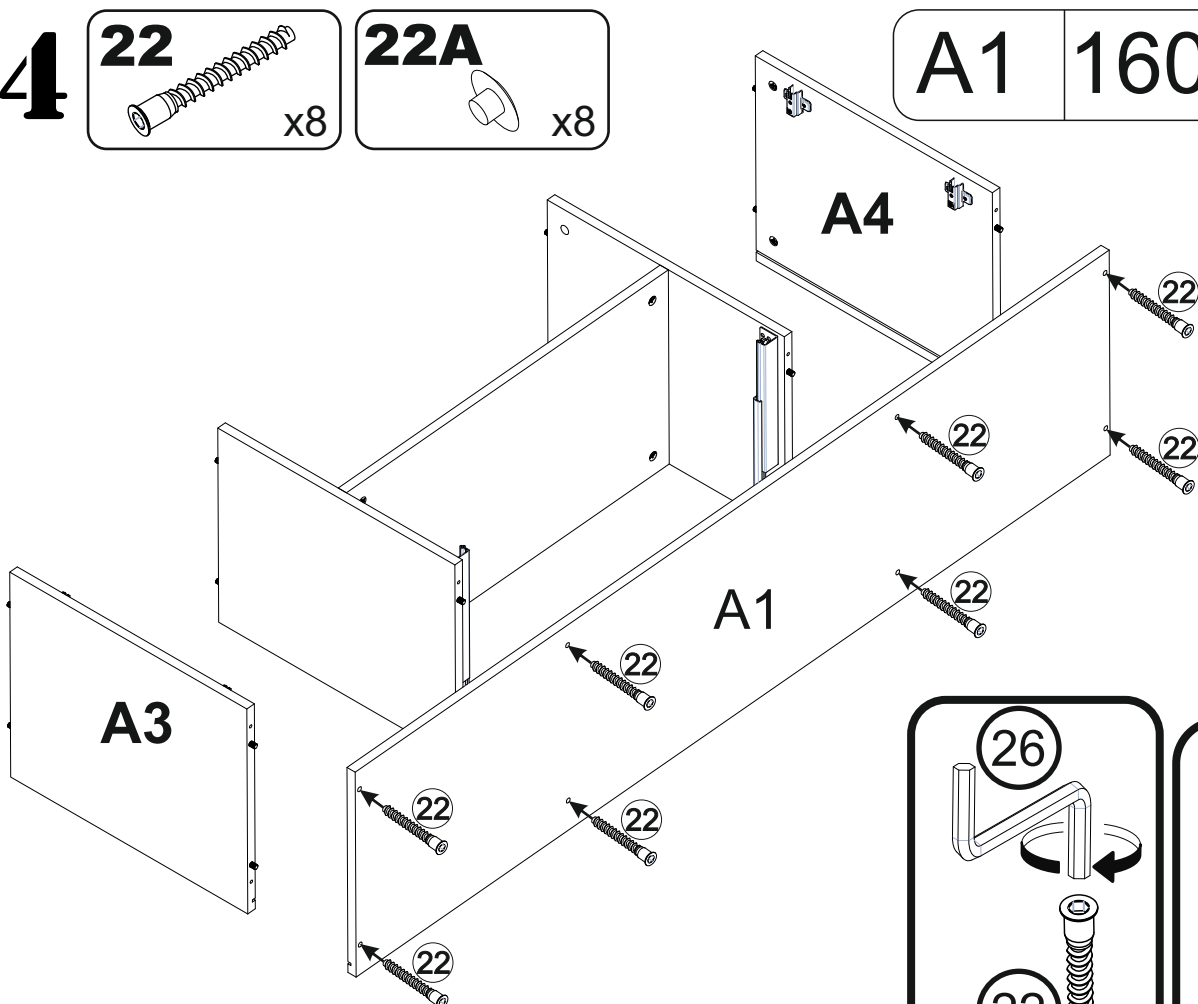

Colli nr 1

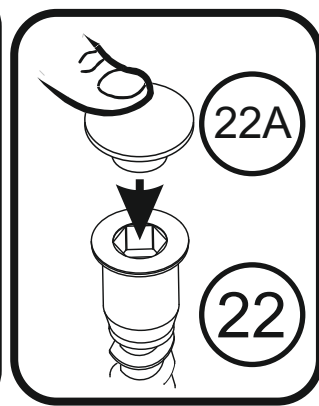
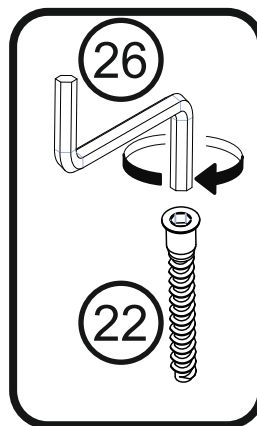

15

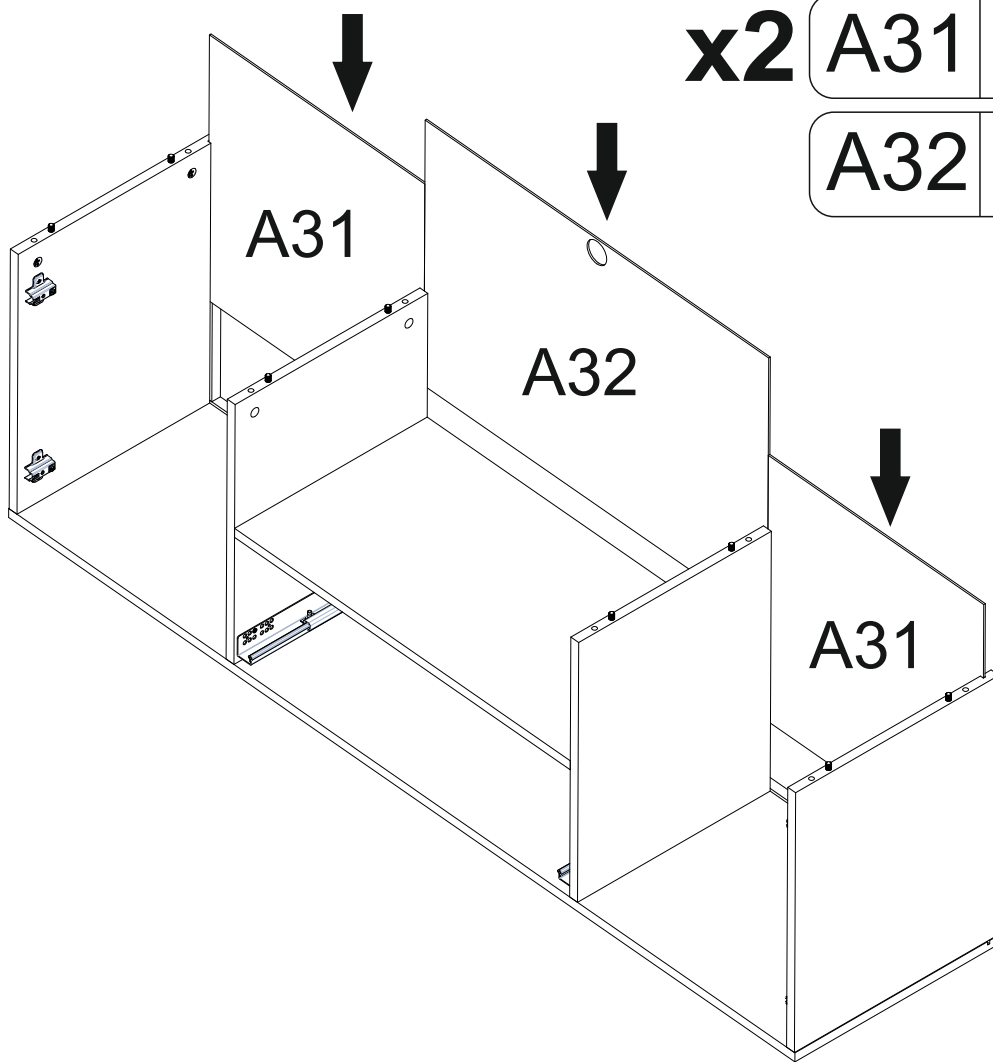

x2

A31

439x472

A32

700x472

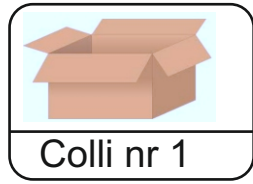

16

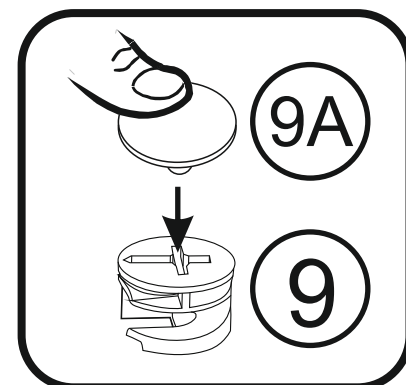
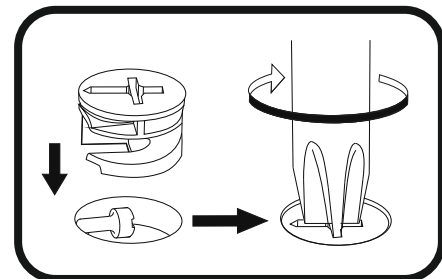
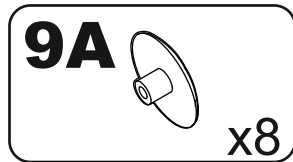
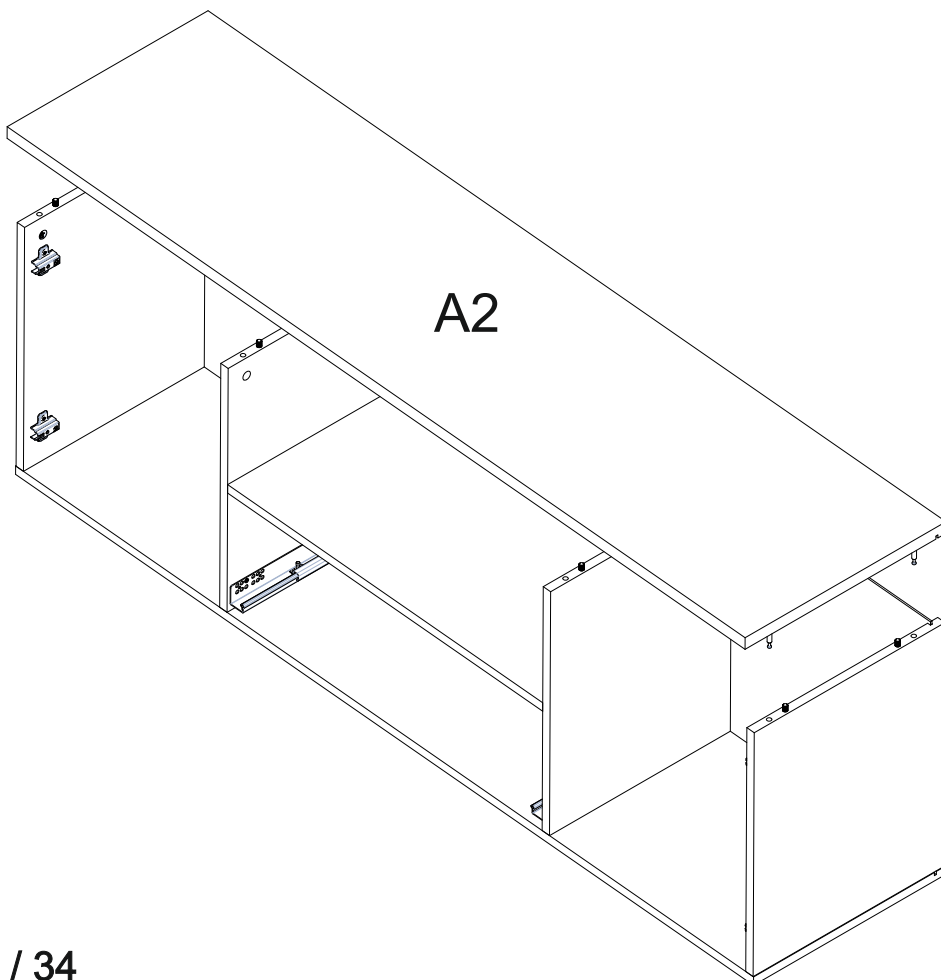

17

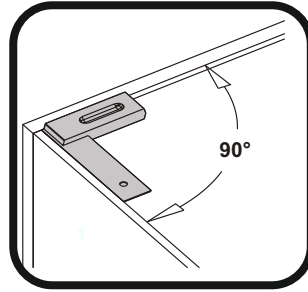
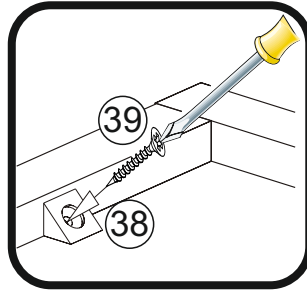
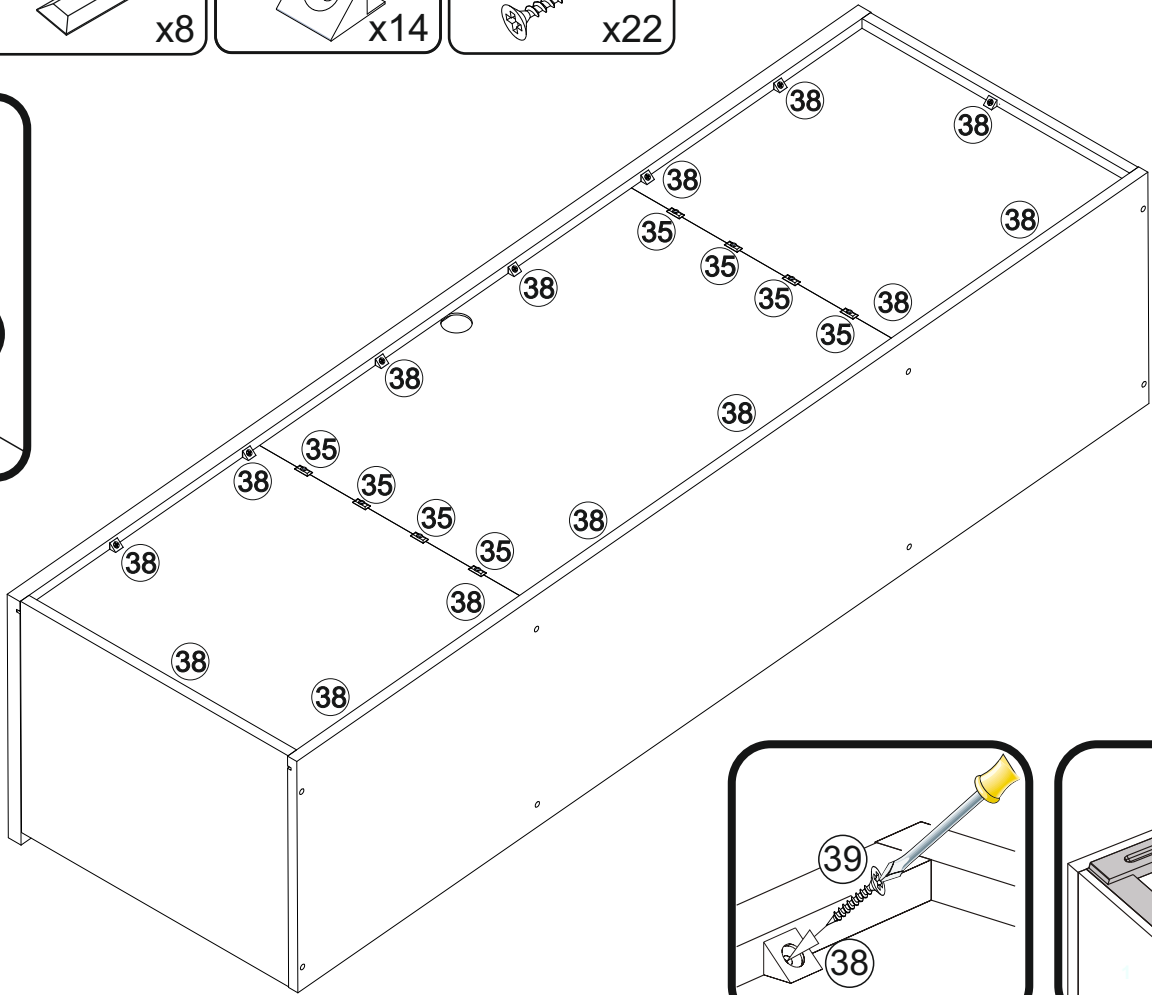
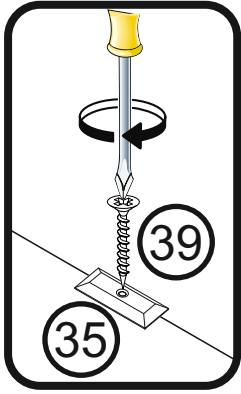
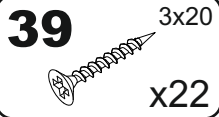
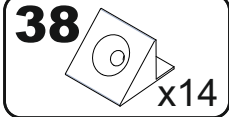

18

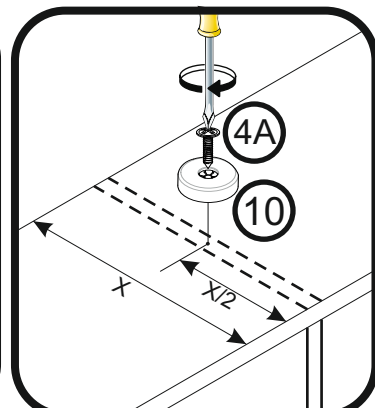
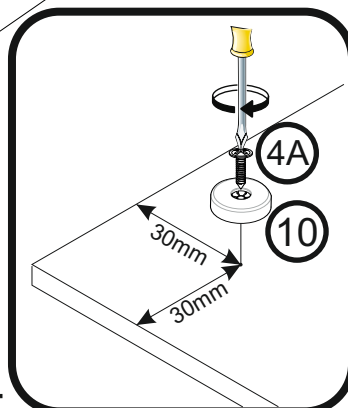
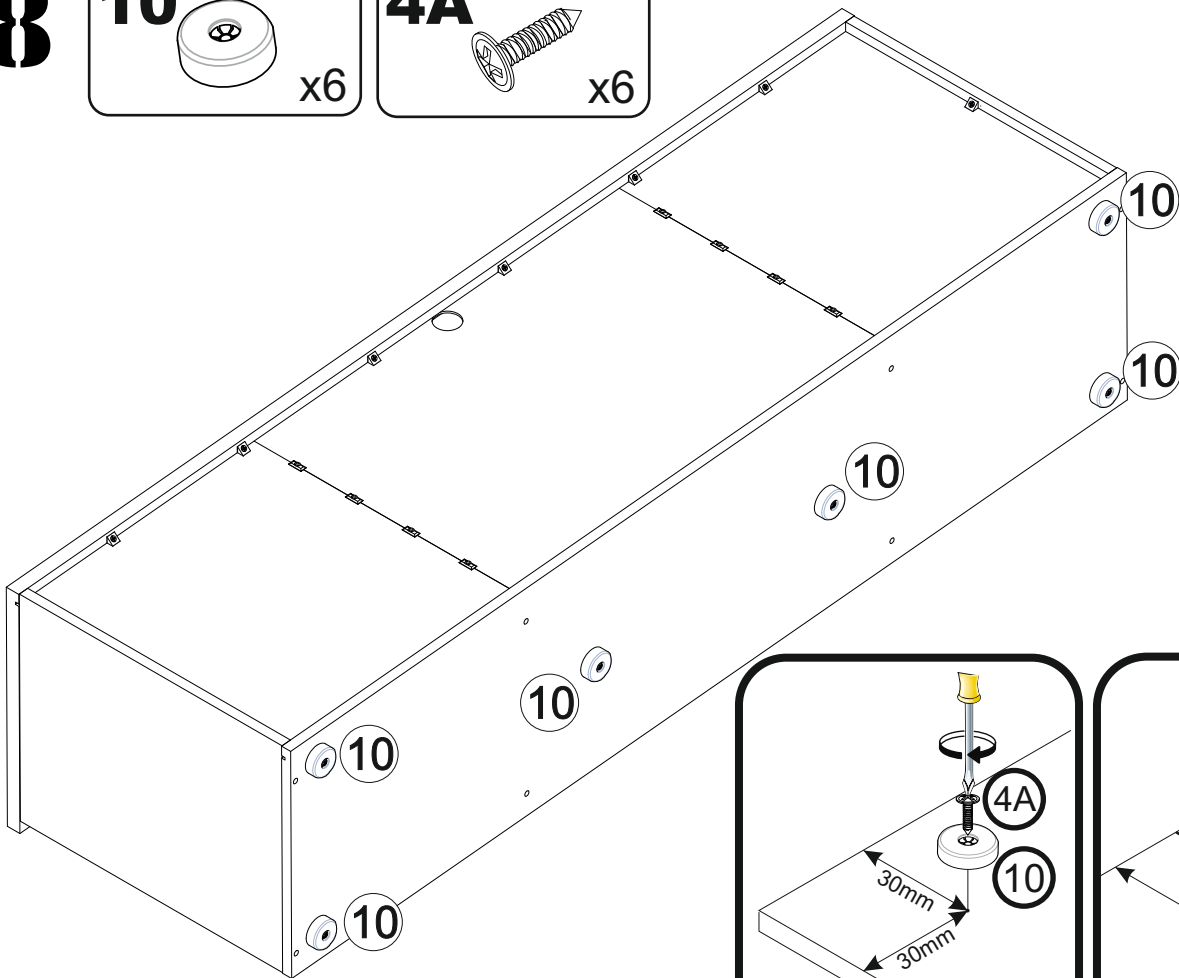
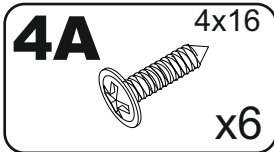
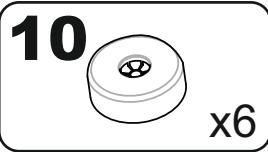

19

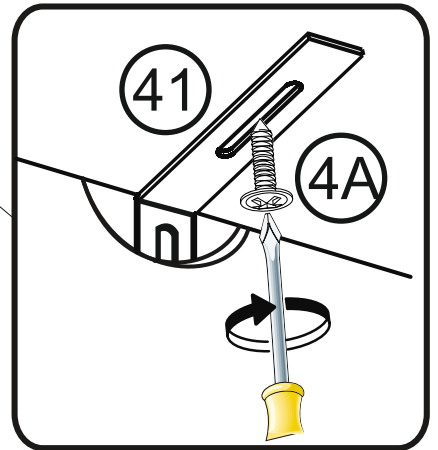
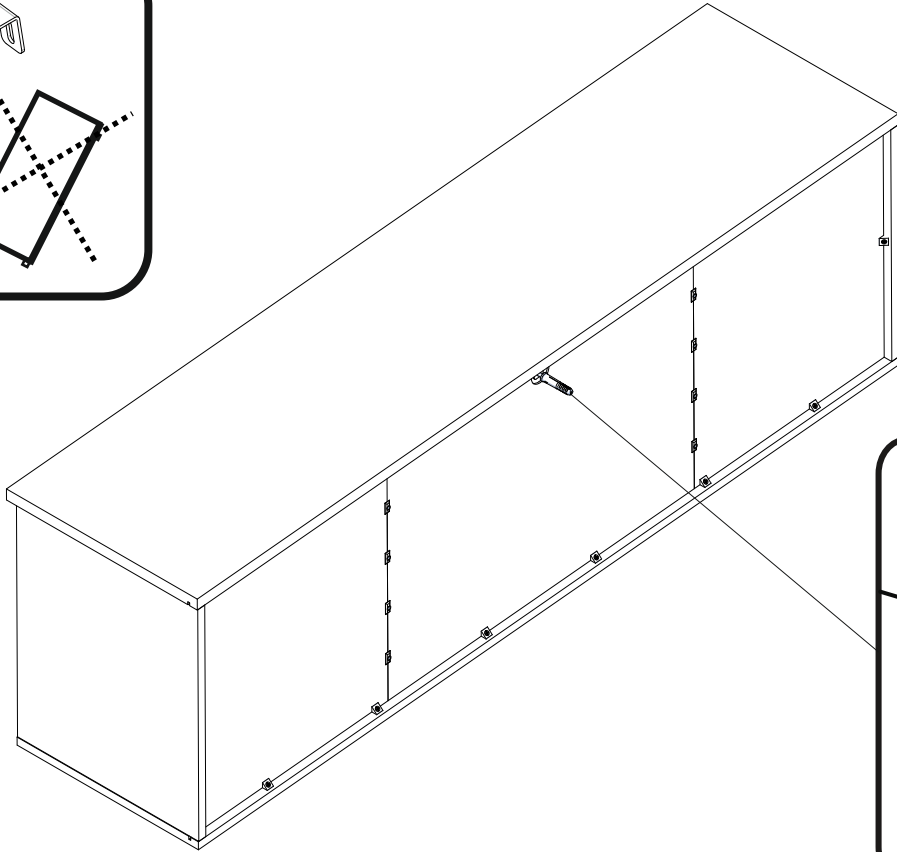
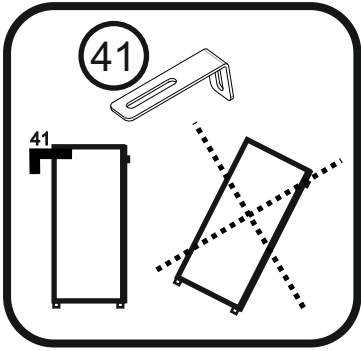
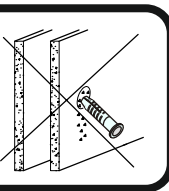
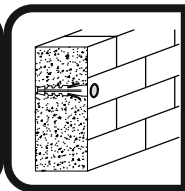
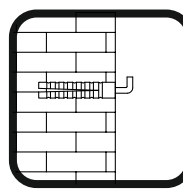
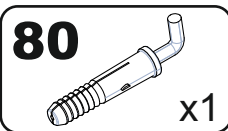
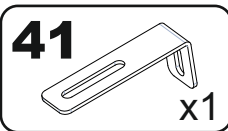
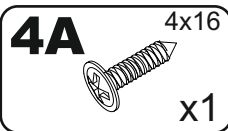

20

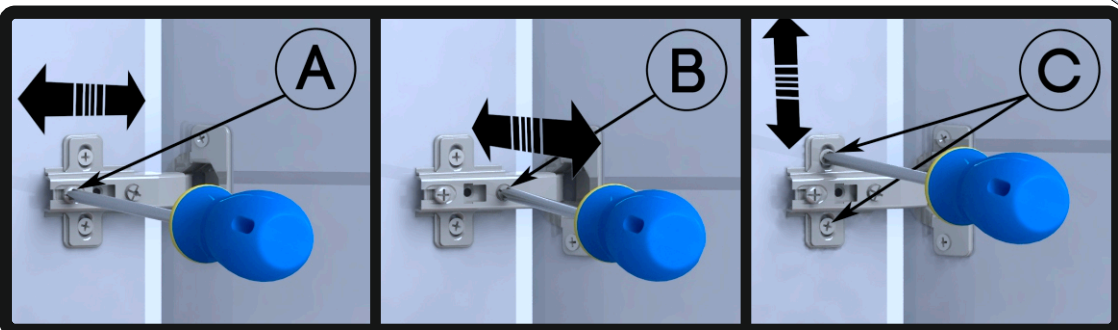
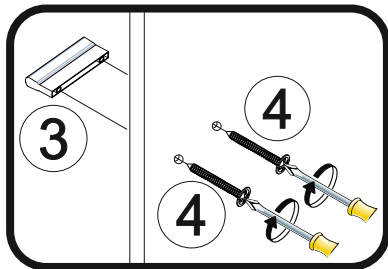
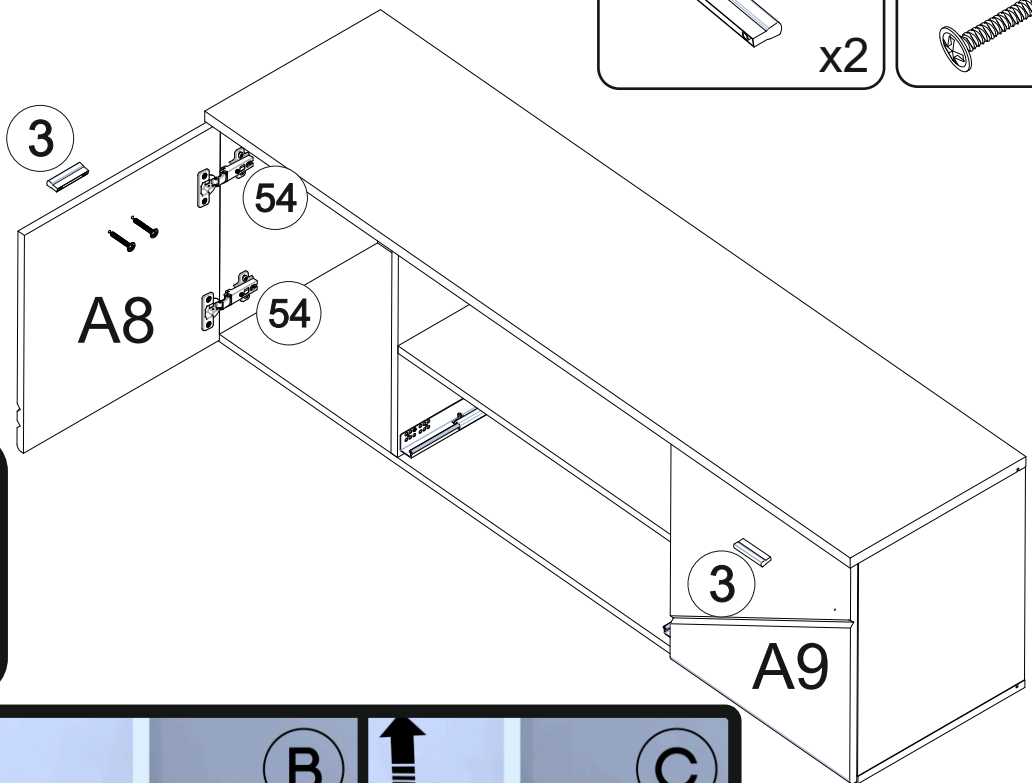
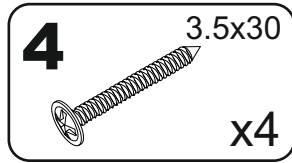
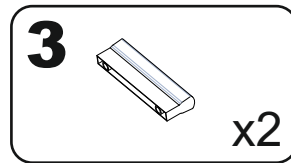

21

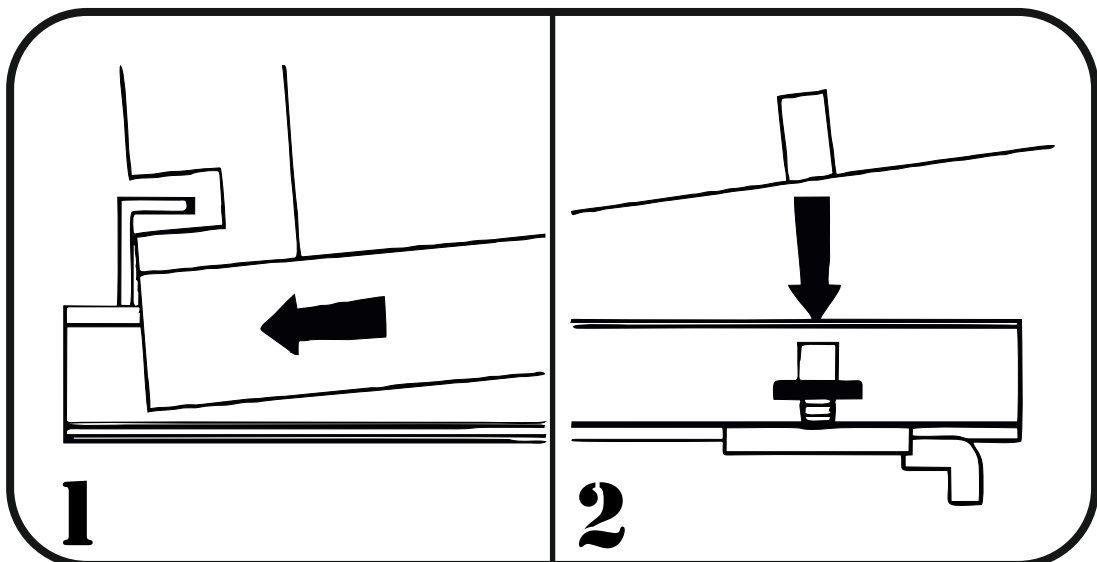
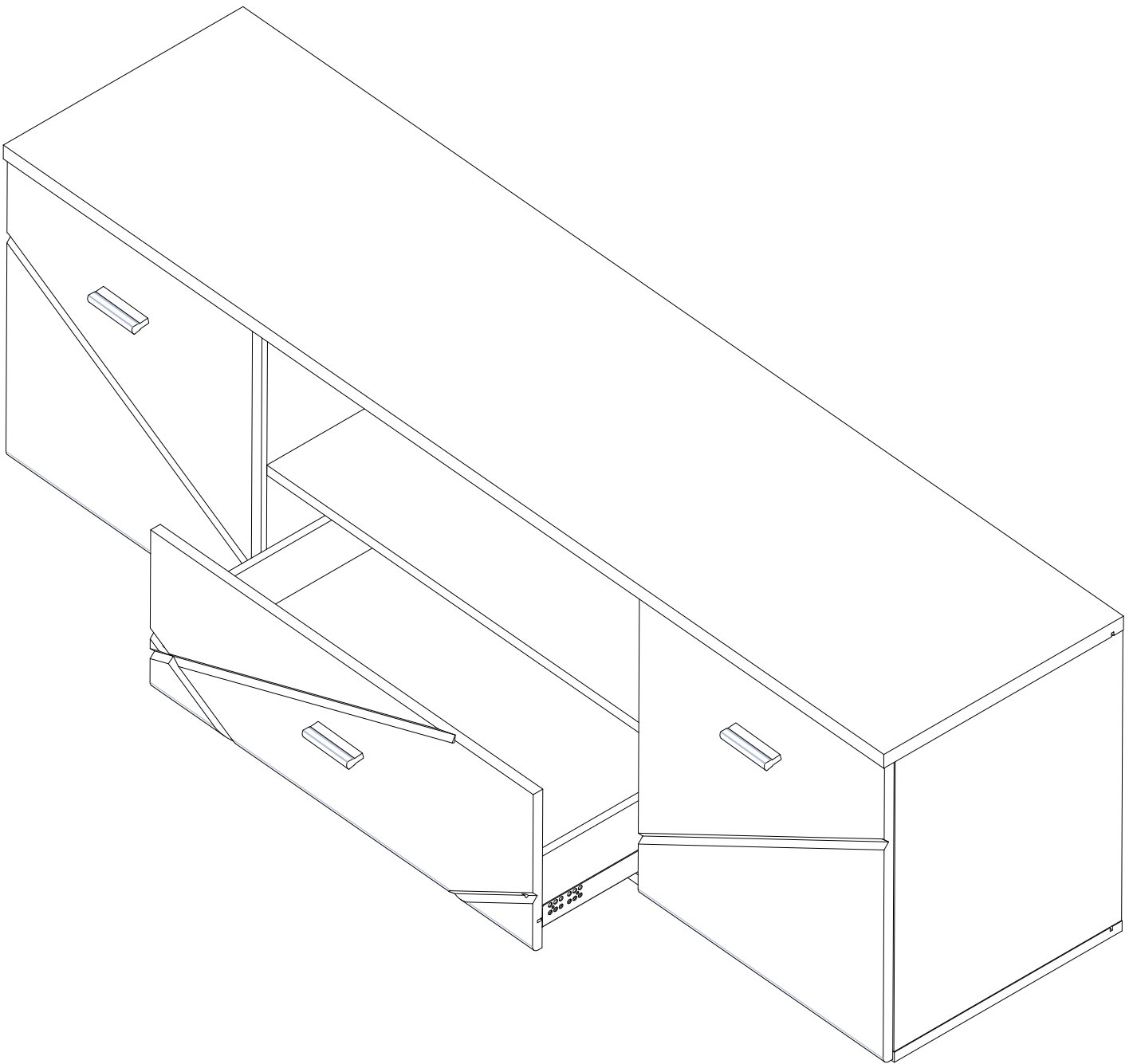

B

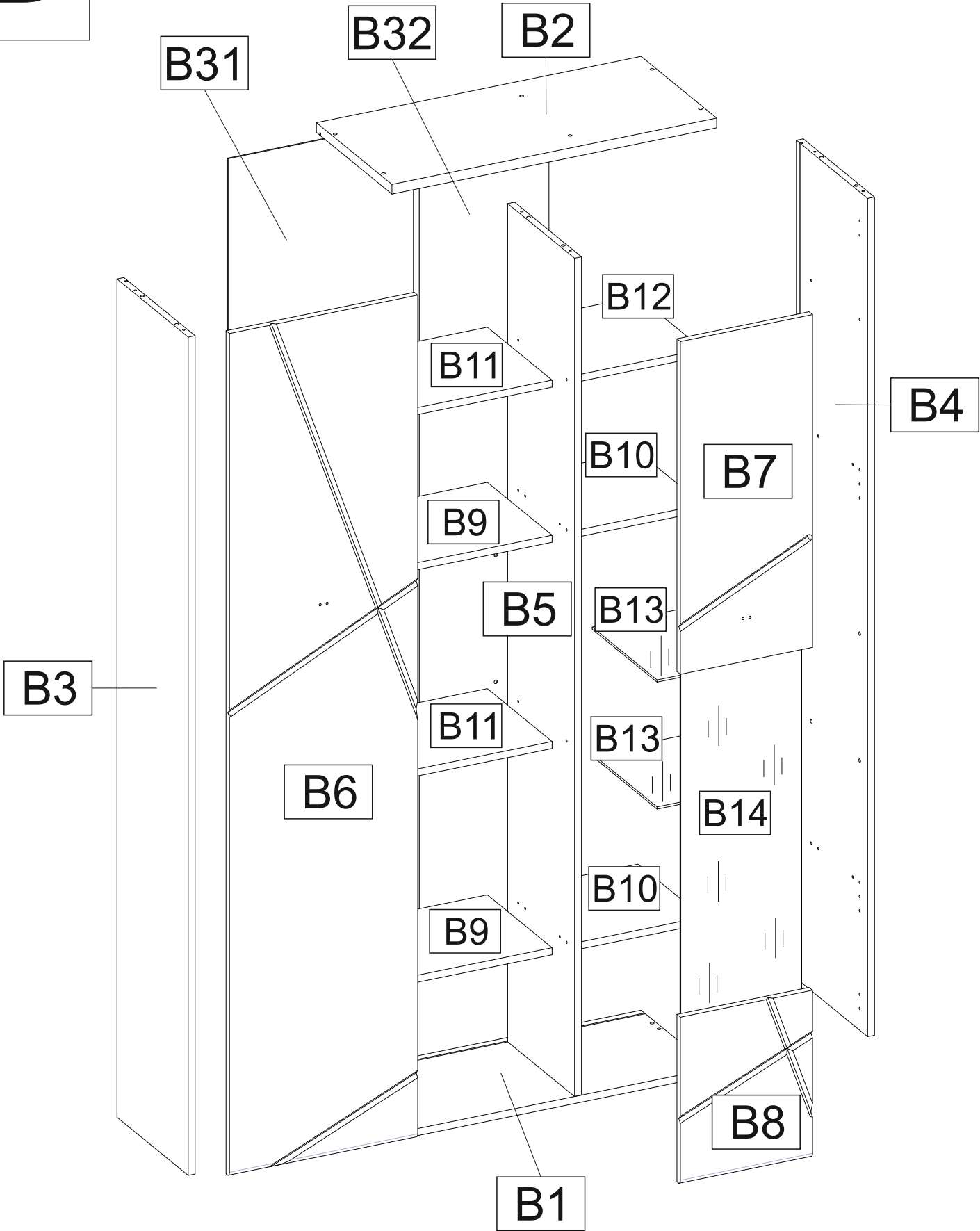

1

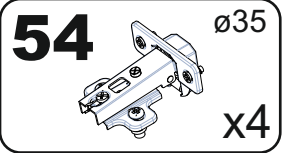
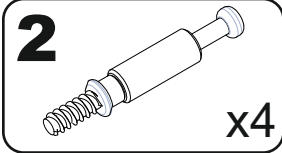
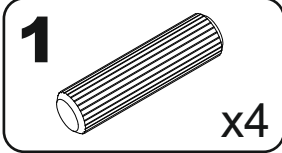

B3 1902x330

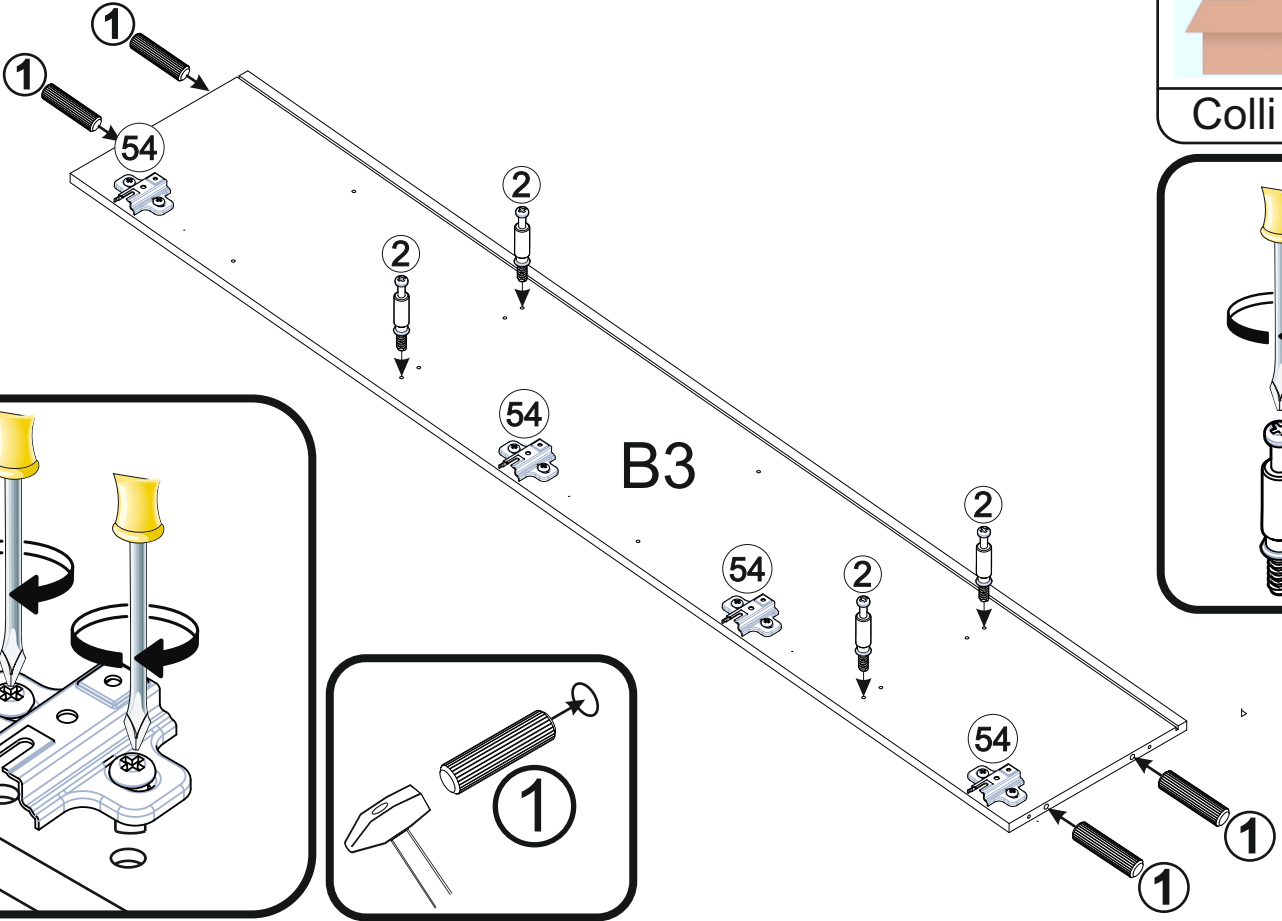
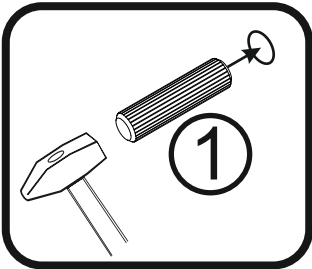
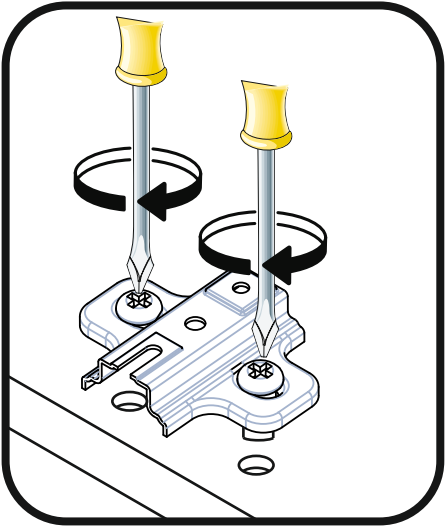
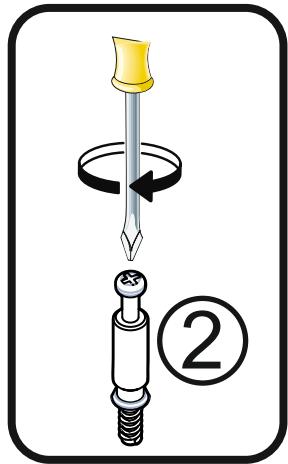
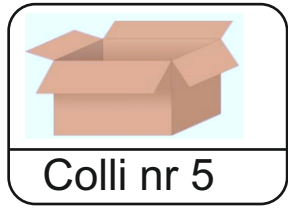

2

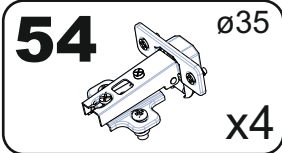
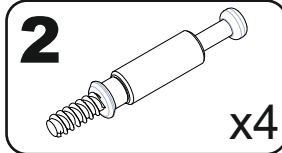
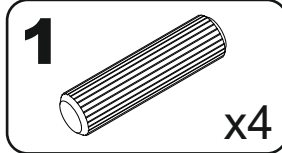

B4 1902x330

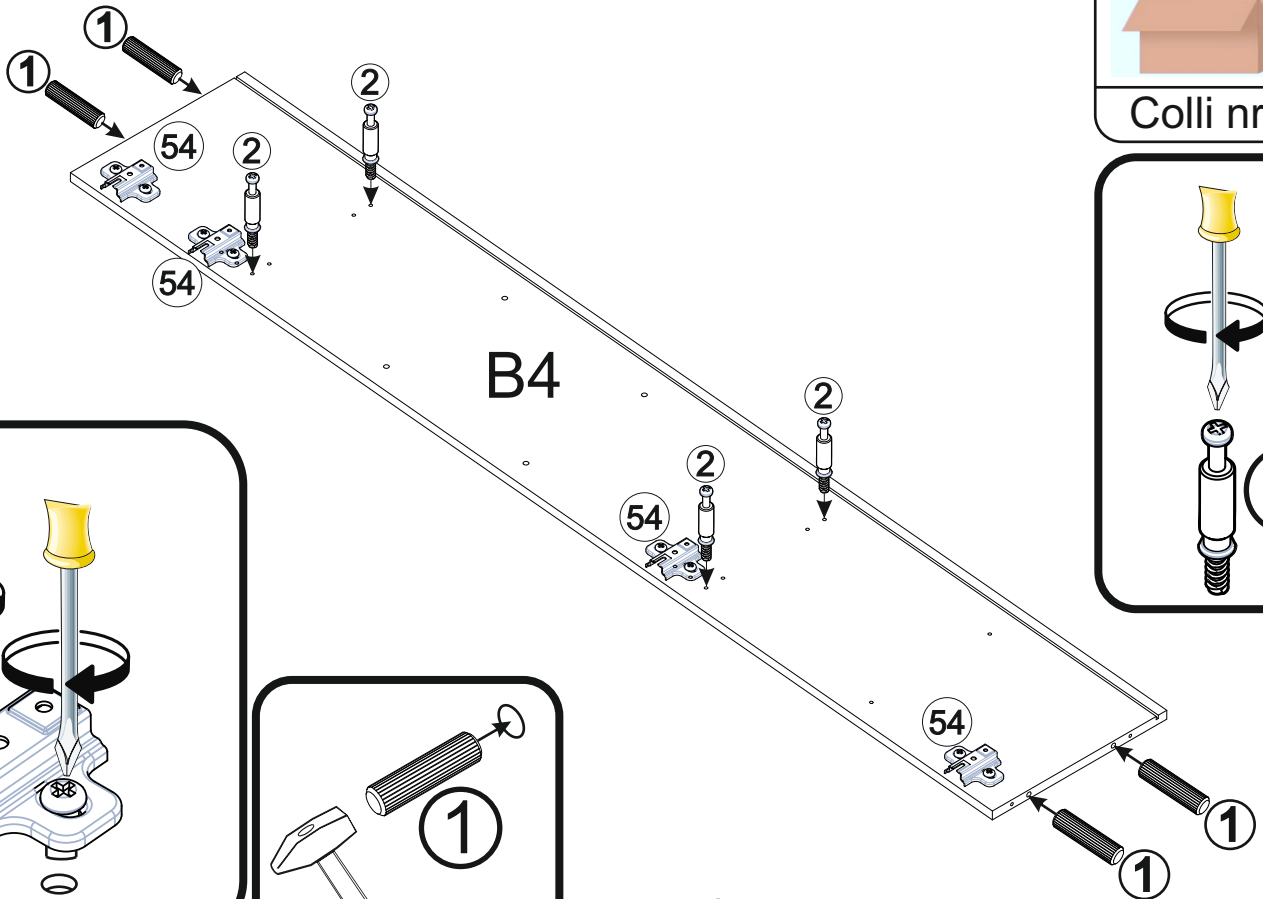
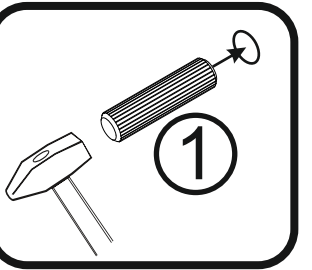
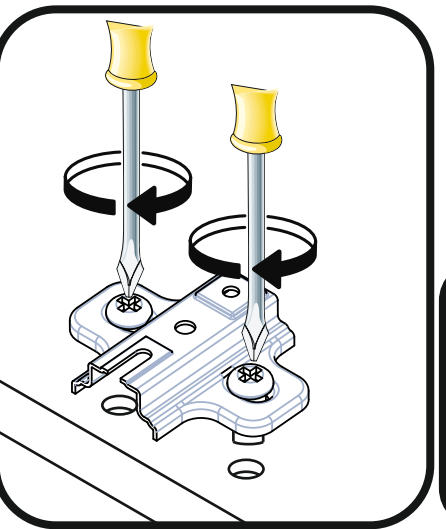
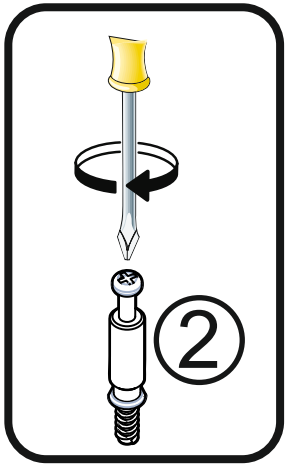
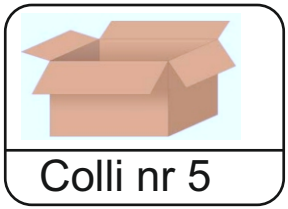

3

9

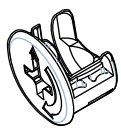

ø15

x16

9

B9

x2

B9

416x330

B10

286x300

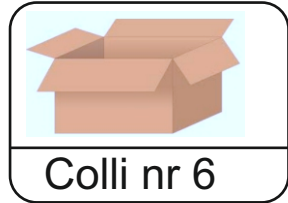

Colli nr 6

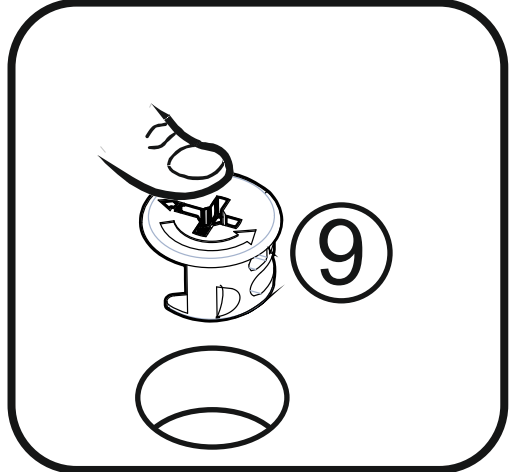
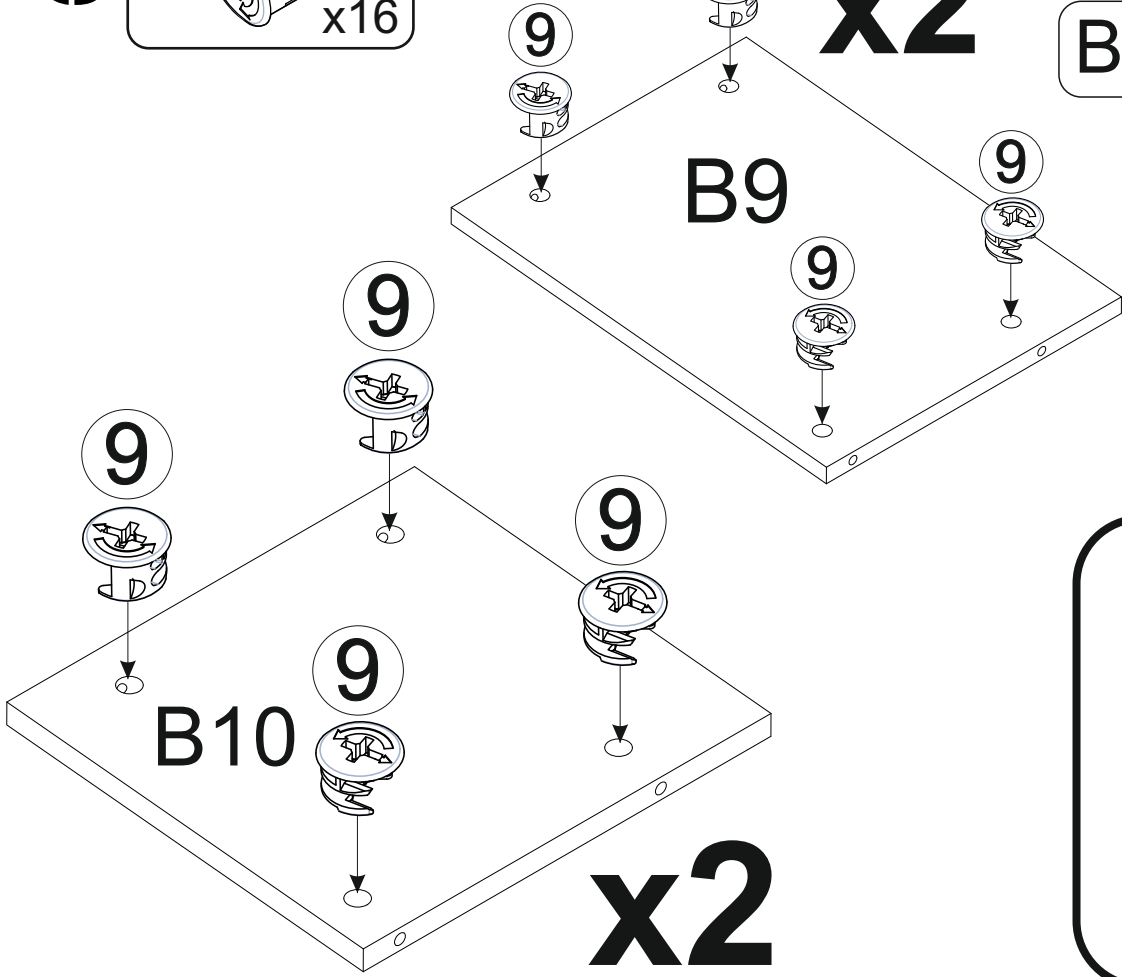

4

1

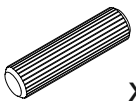

x4

2

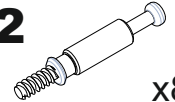

x8

B5

1902x310

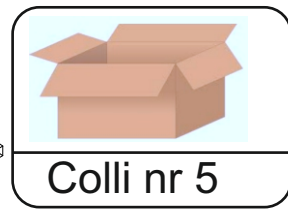

Colli nr 5

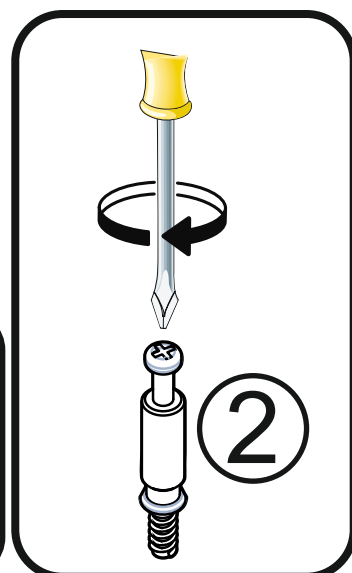
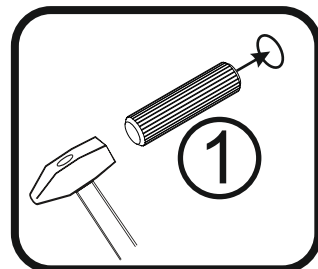
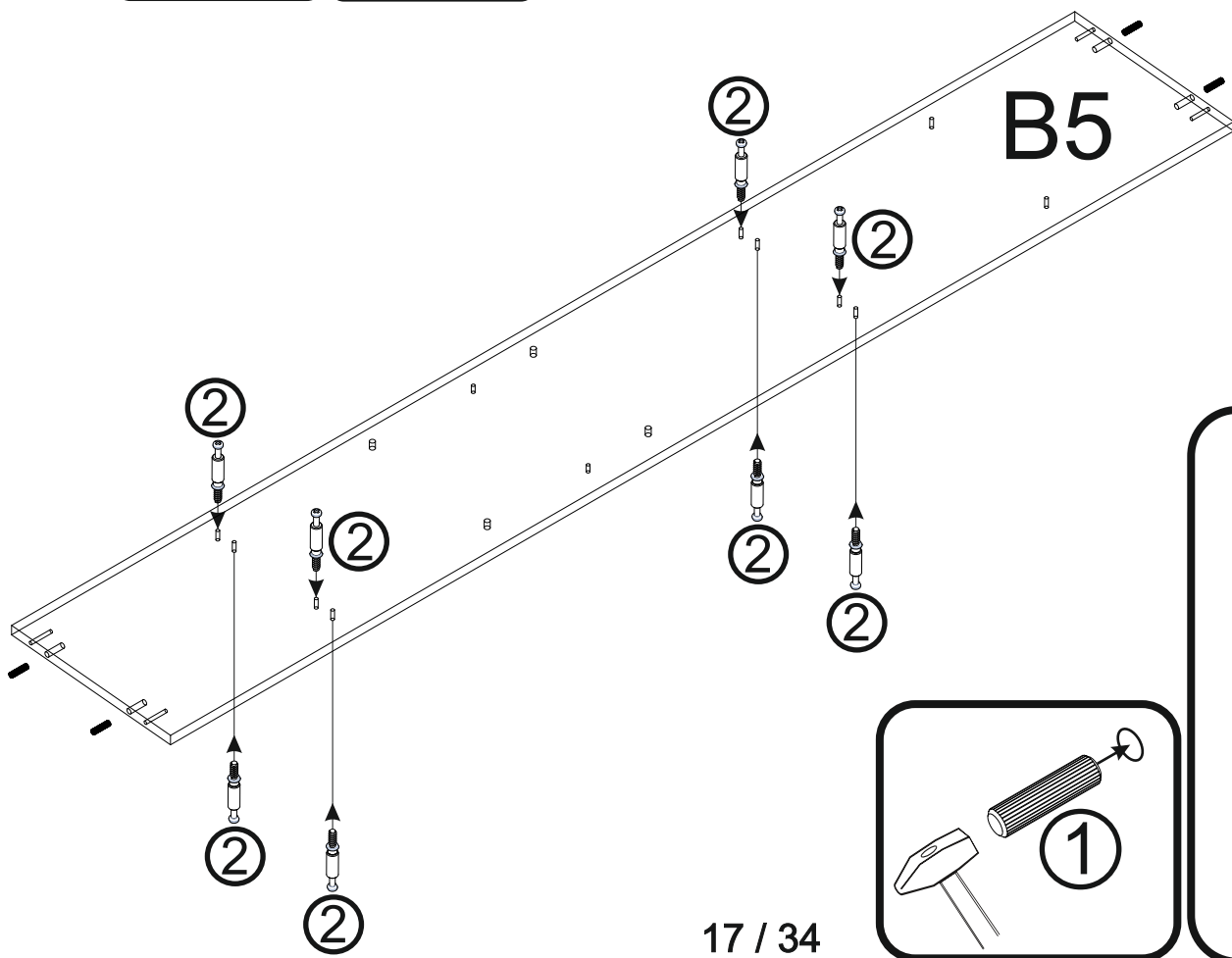

5

54 $\varnothing 35$
x4

6 5x11
x8

B6	1913x436
-----------	-----------------

Colli nr 5

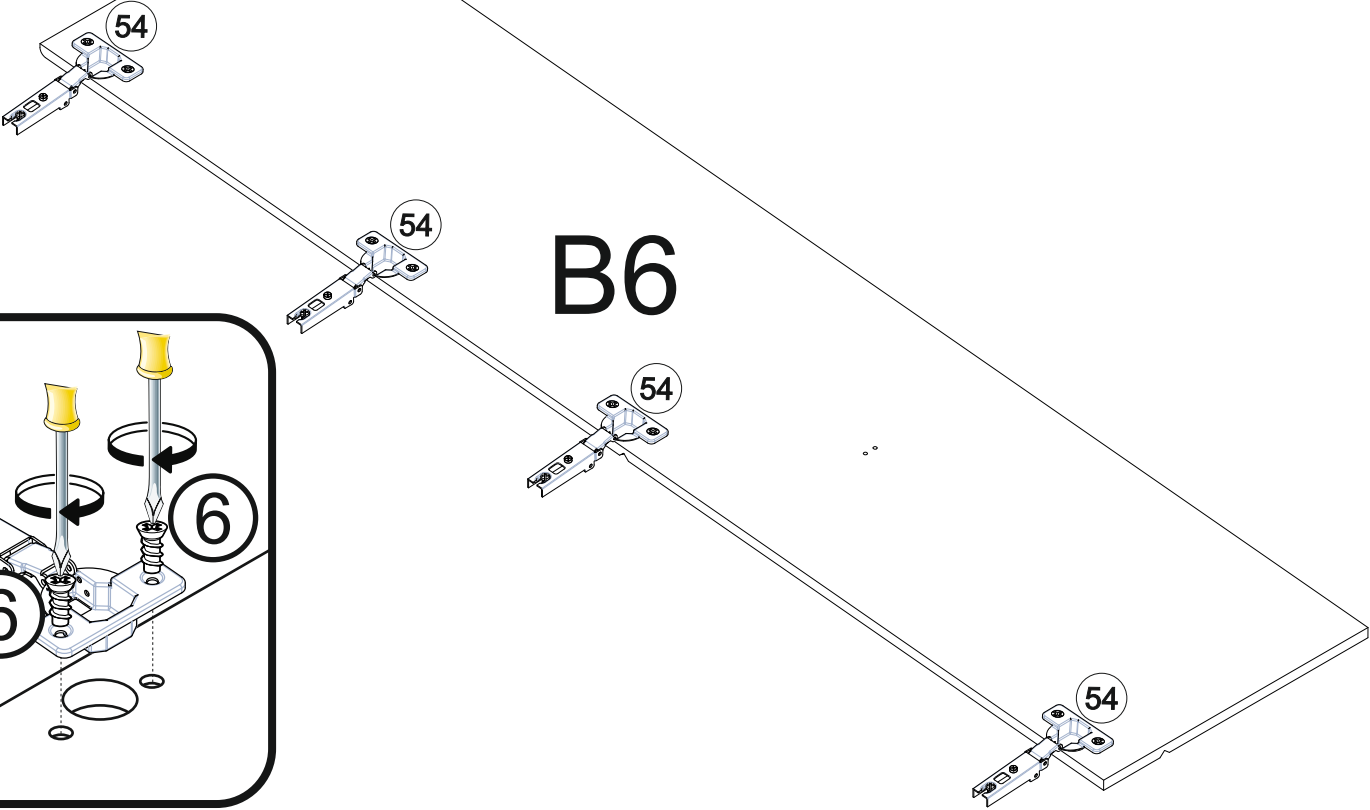

B6

6 **36**
x6

4A 4x16
x6

54 $\varnothing 35$
x4

6 5x11
x8

B7	306x755
-----------	----------------

B8	306x380
-----------	----------------

B14	838x280
------------	----------------

Colli nr 6

Colli nr 3

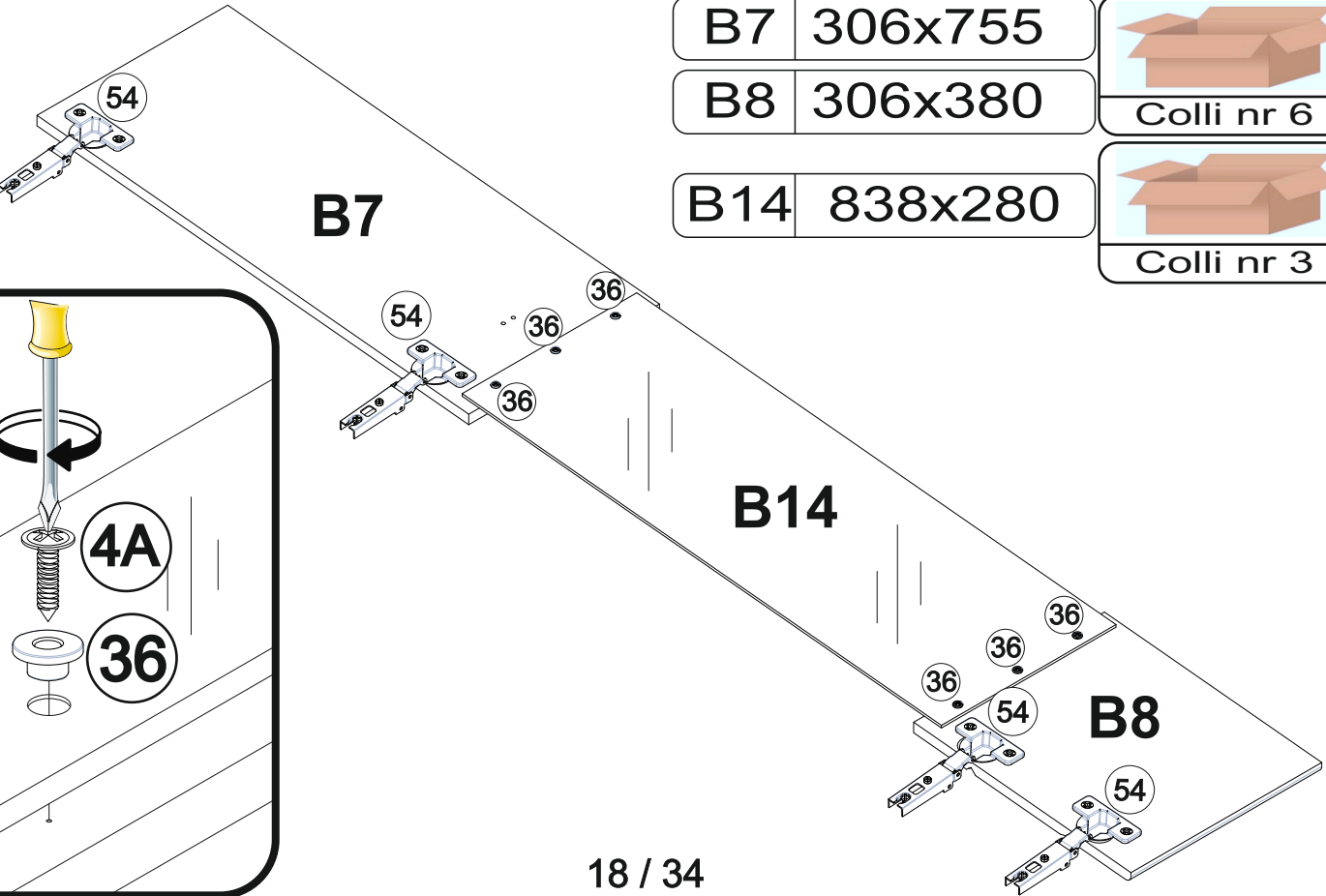

B7

B14

B8

7

9A

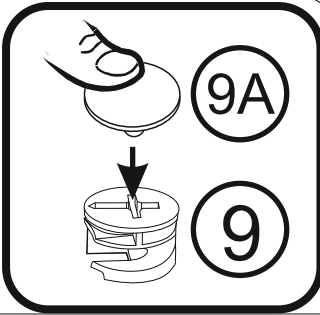
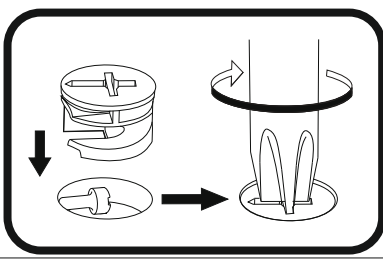
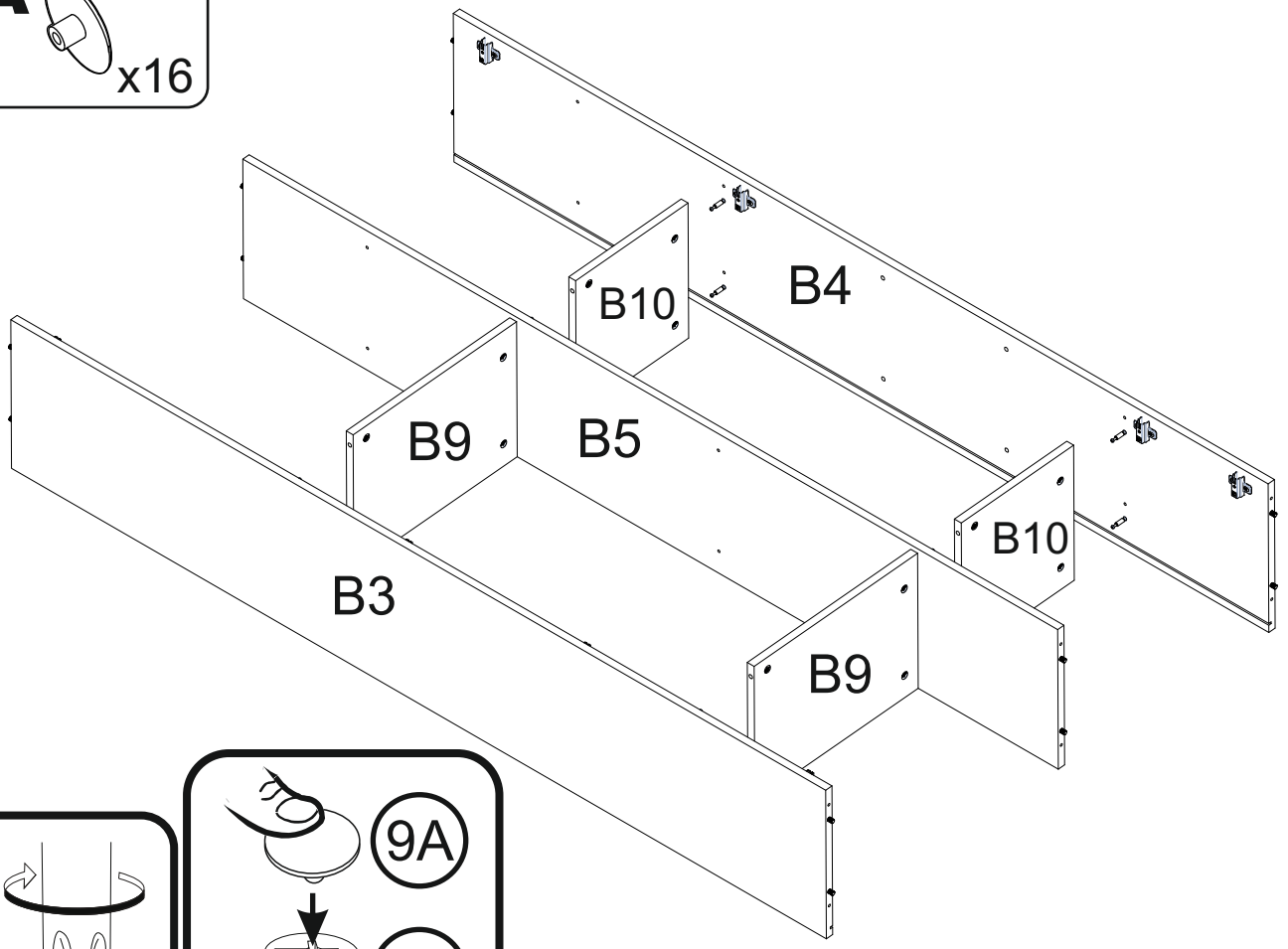
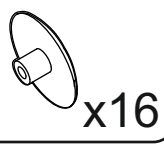

8

22

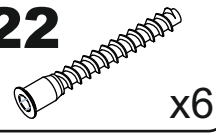

22A

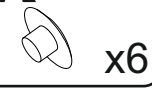

B1 752x330

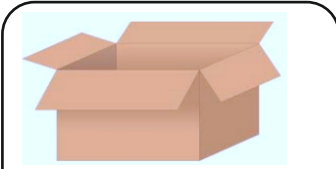

Colli nr 6

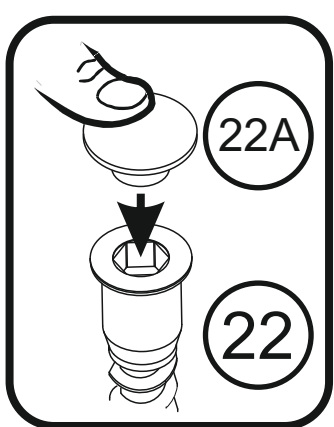
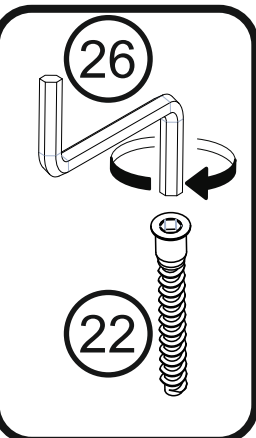
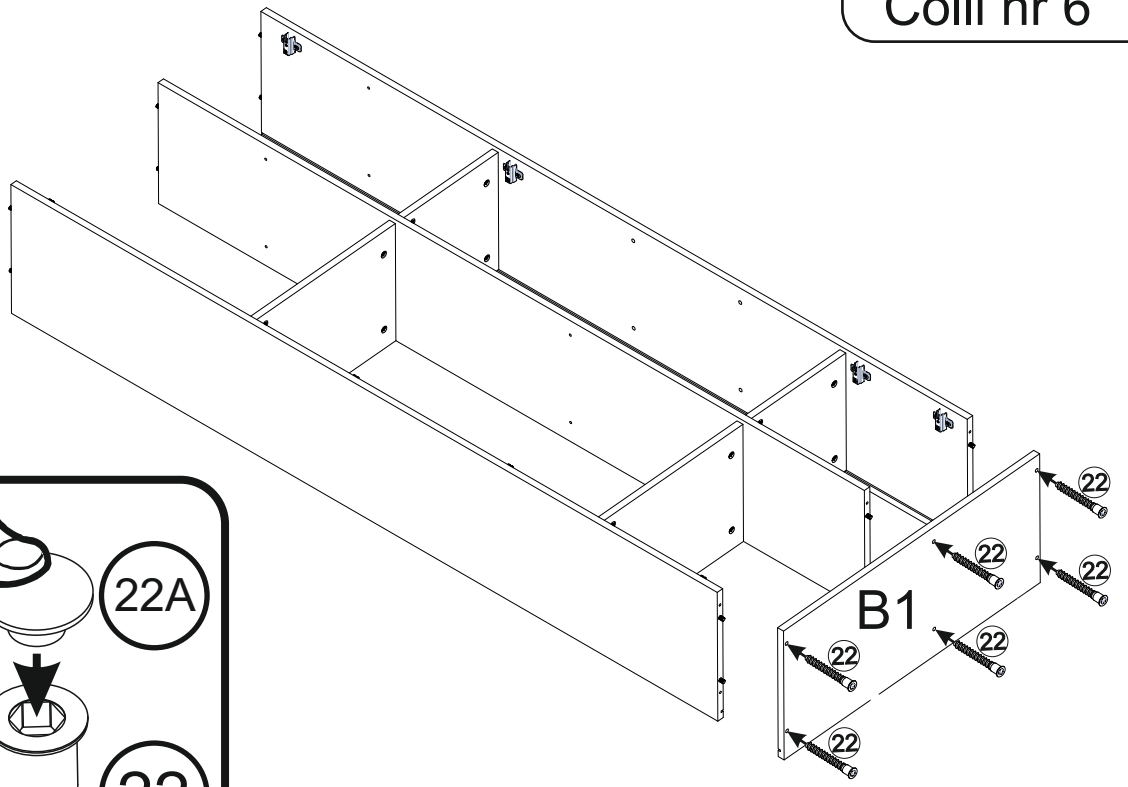

9

B31 1912x429

B32 1912x299

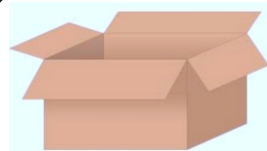

Colli nr 5

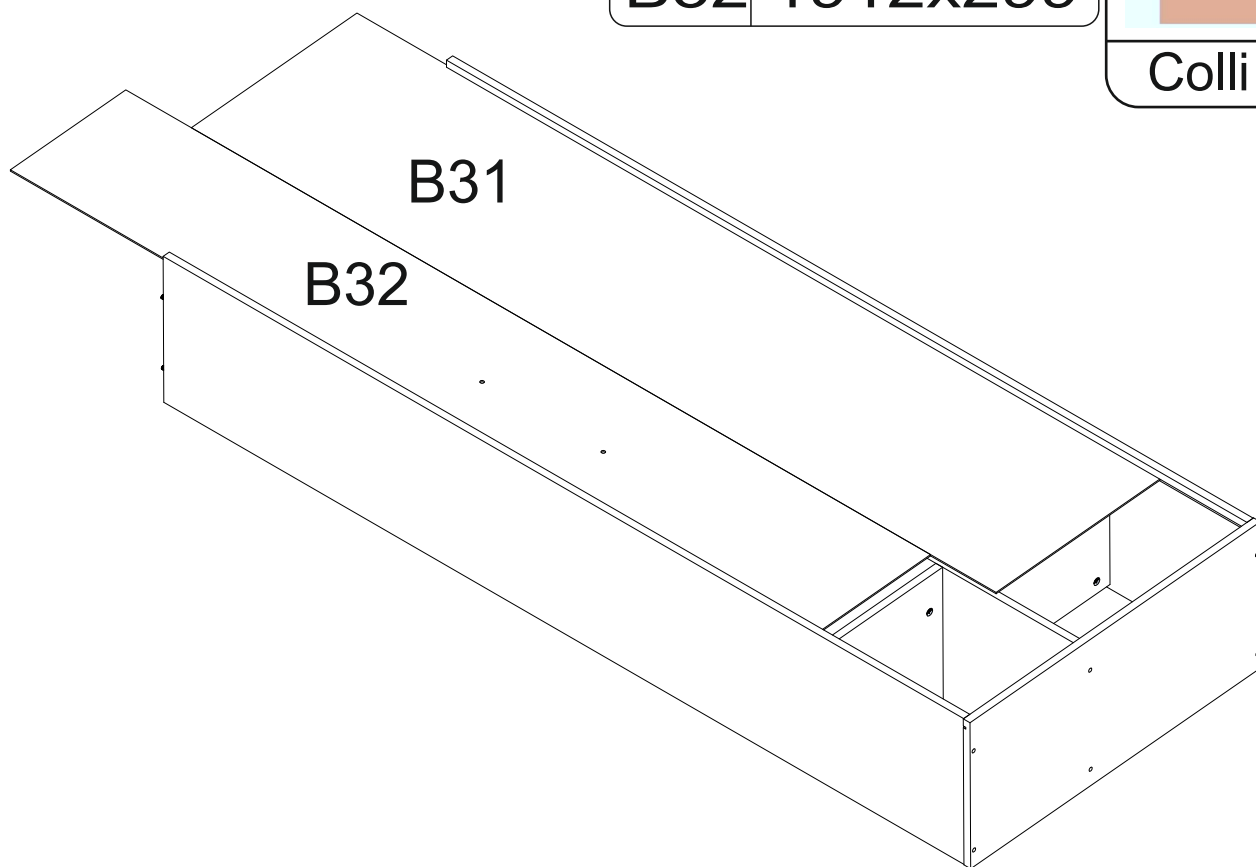

10

22



x6

22A



x6

B2 752x350

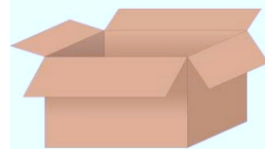

Colli nr 6

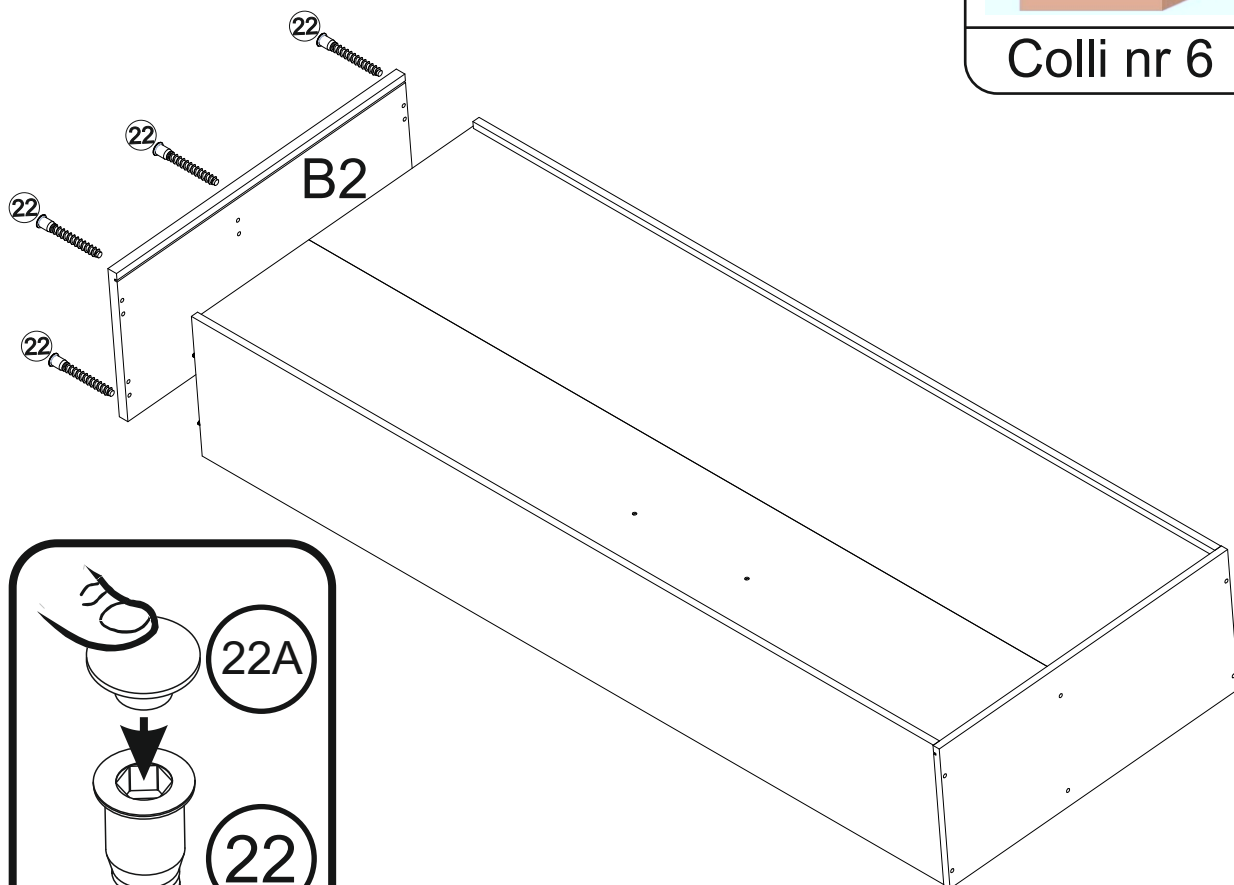

26

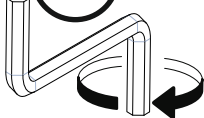

22



22A



22

11

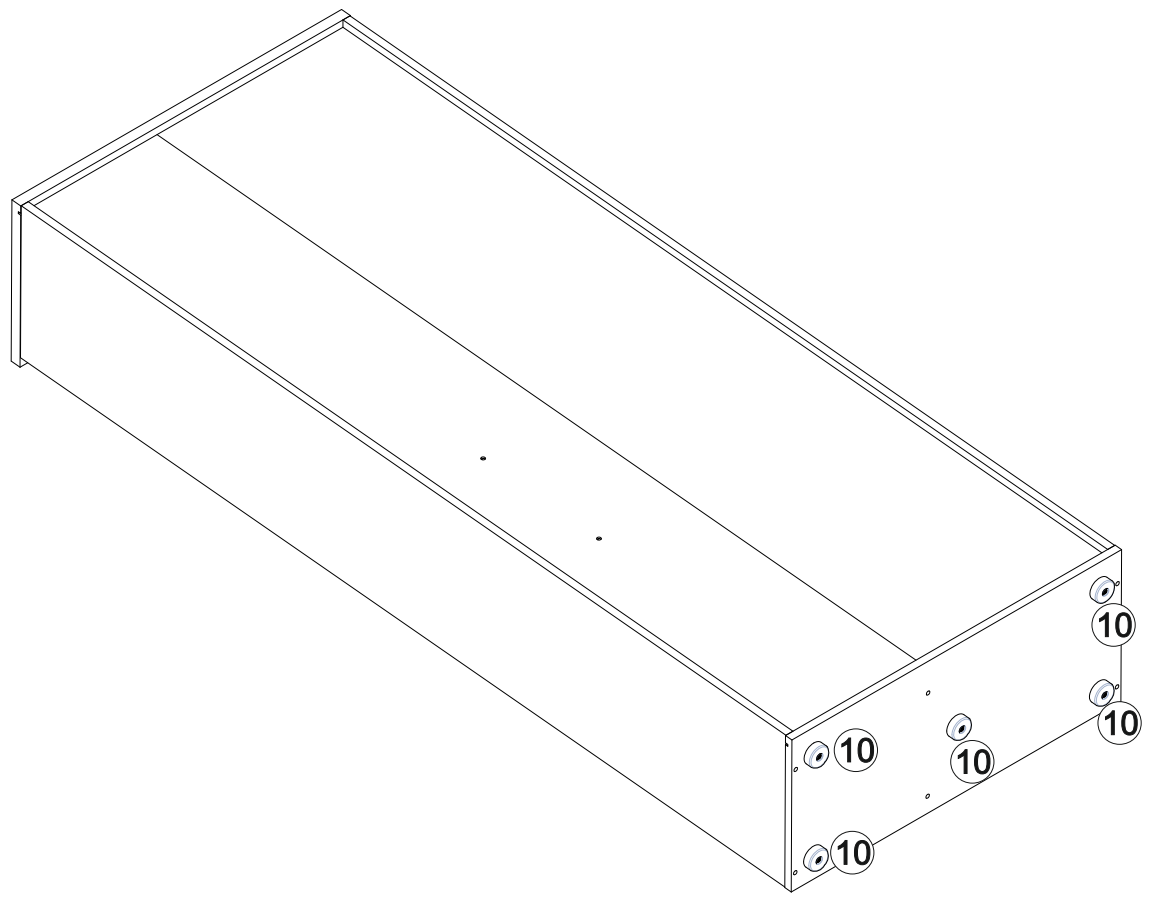
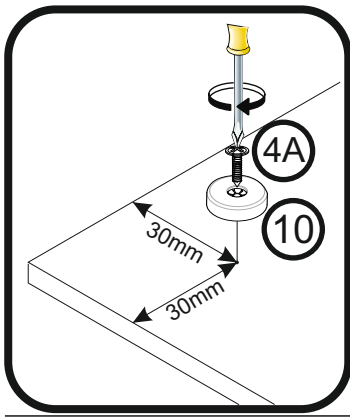
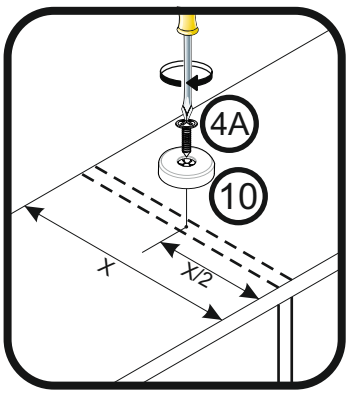
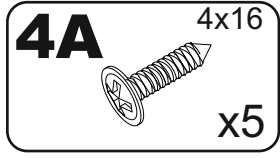
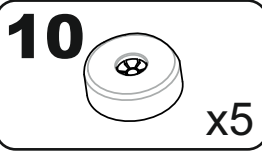

12

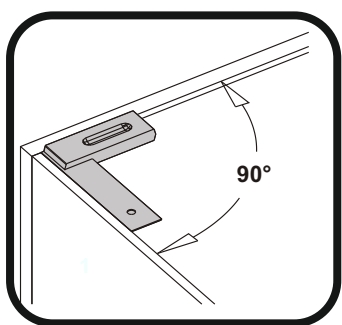
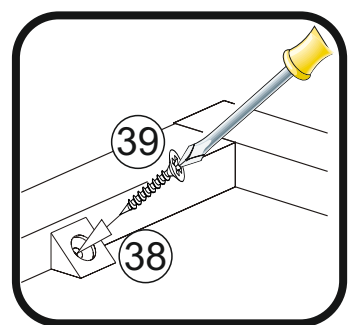
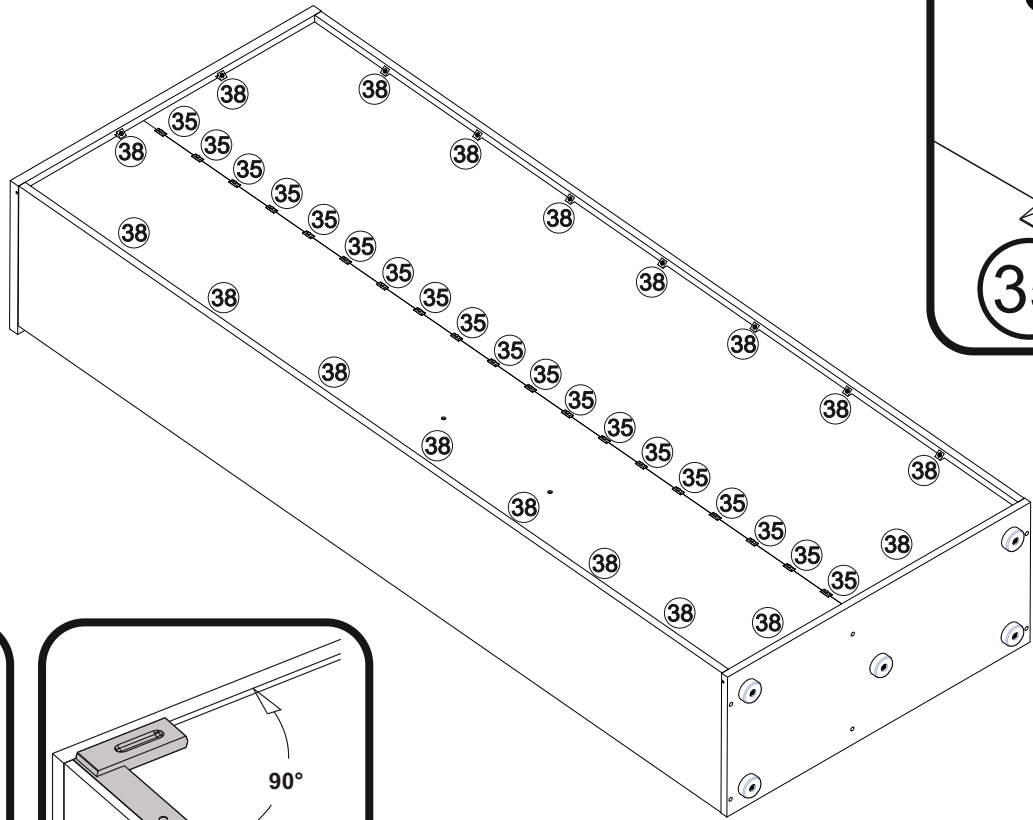
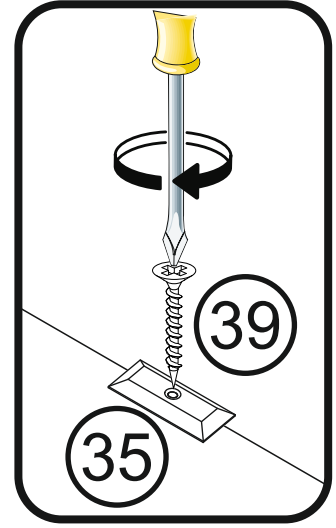
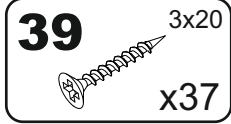
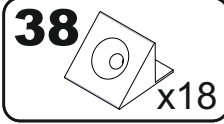
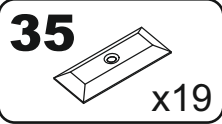

13

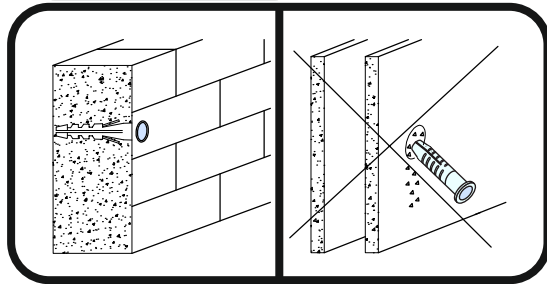
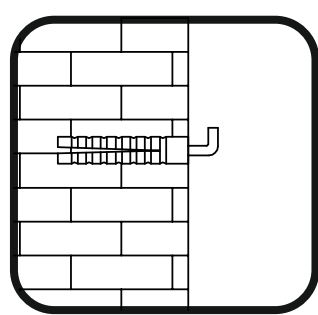
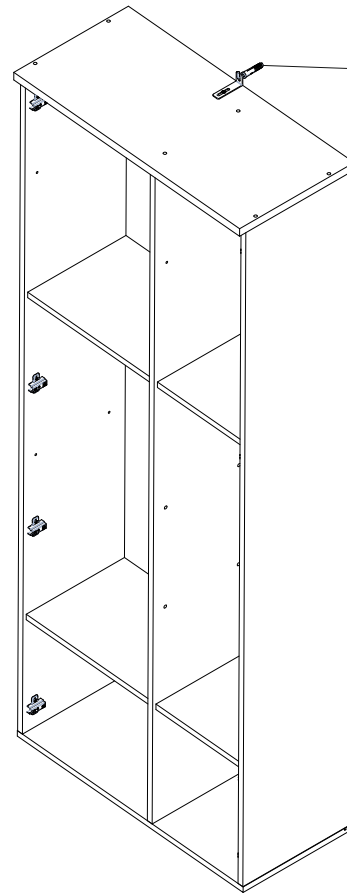
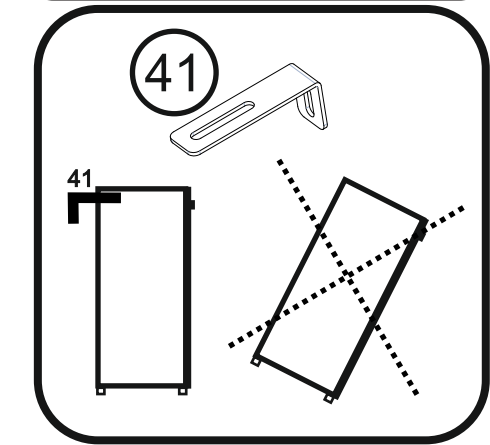
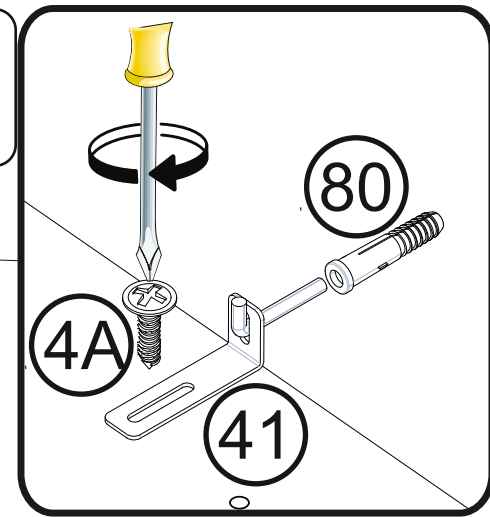
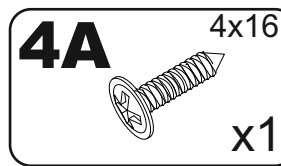
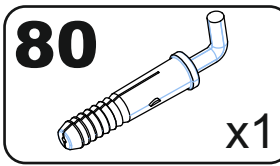
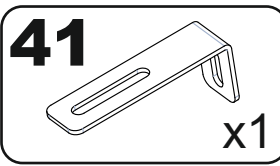

14

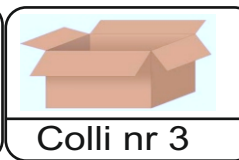
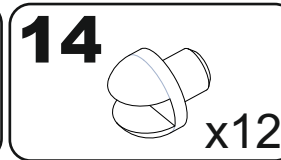
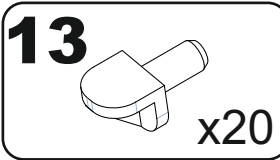

x2 B11 416x300
x1 B12 286x300

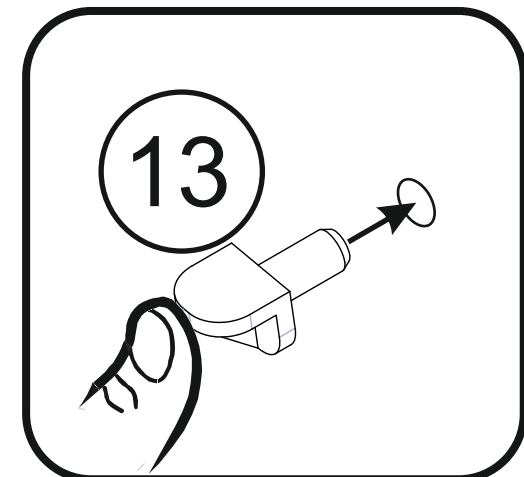
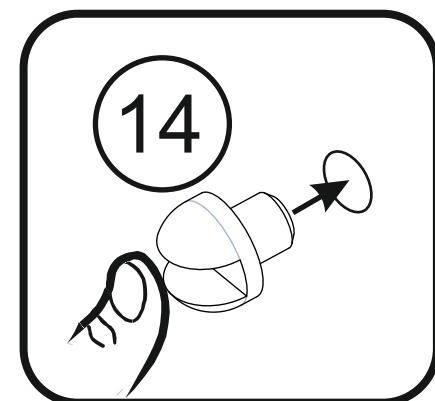
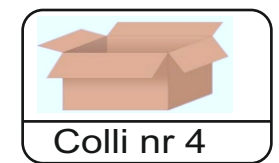
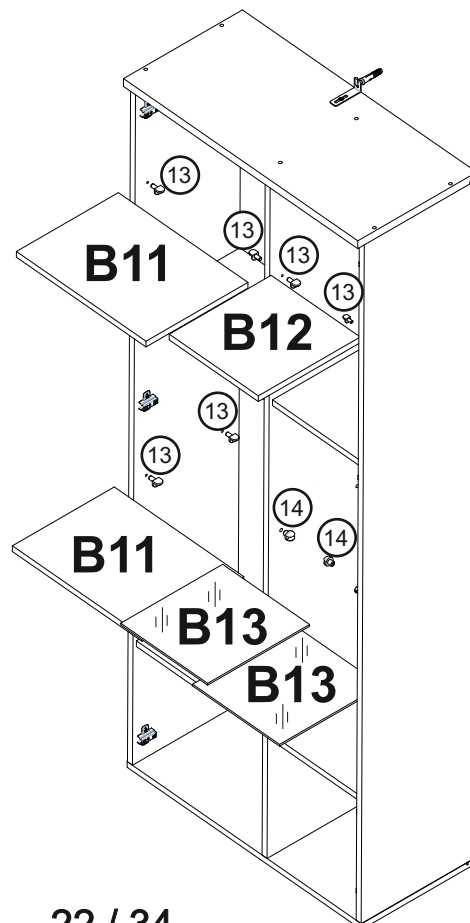

15

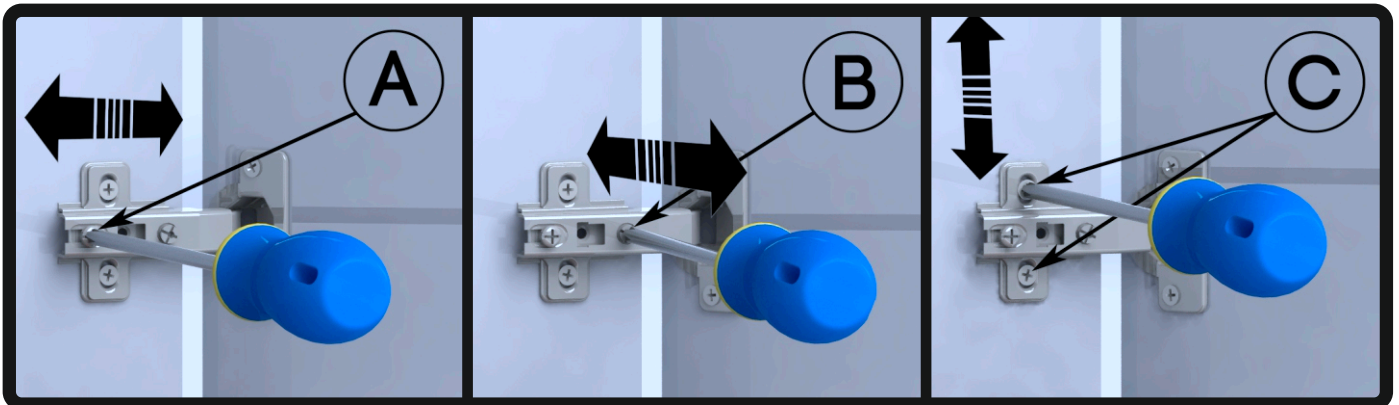
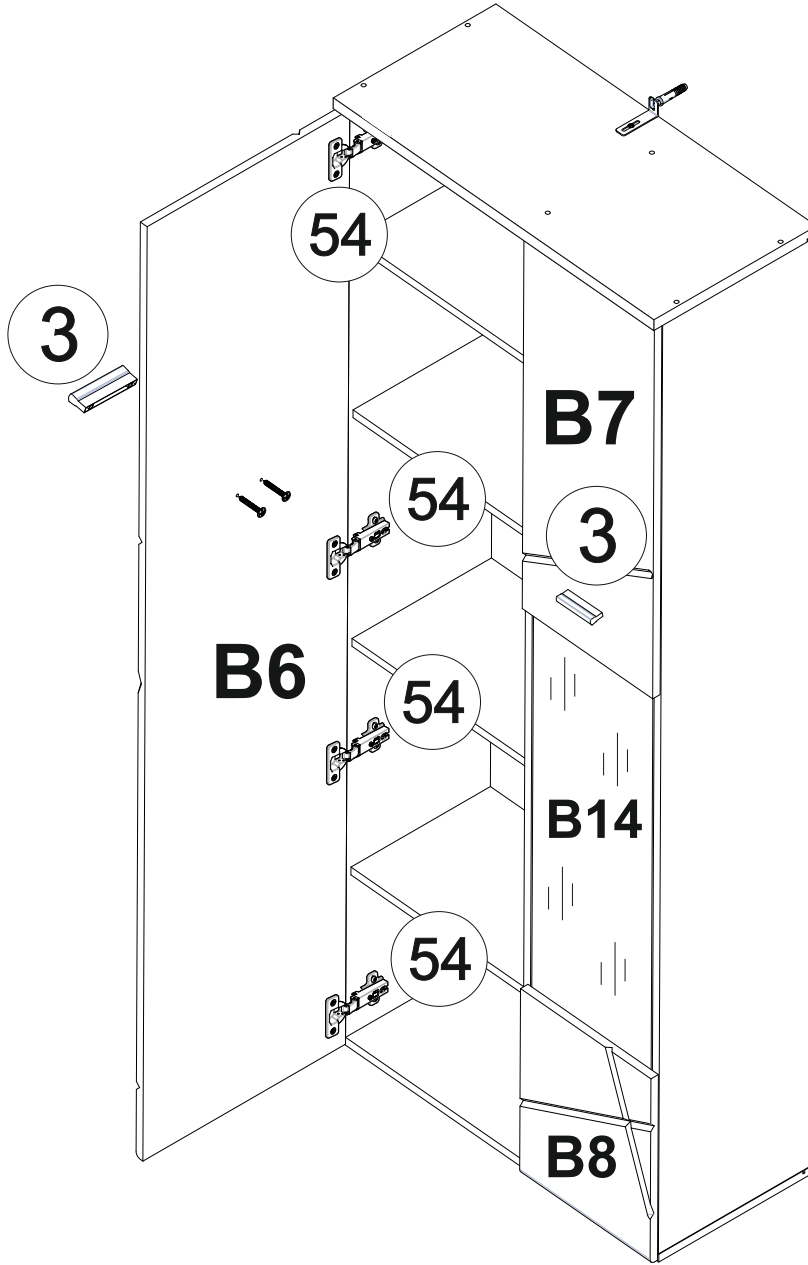
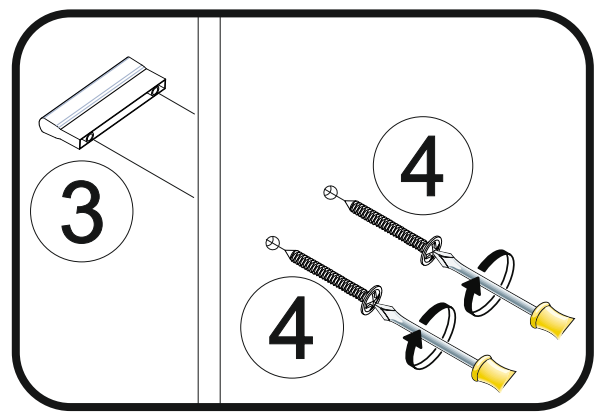
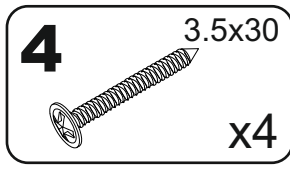
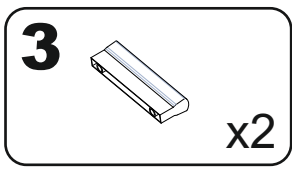

C

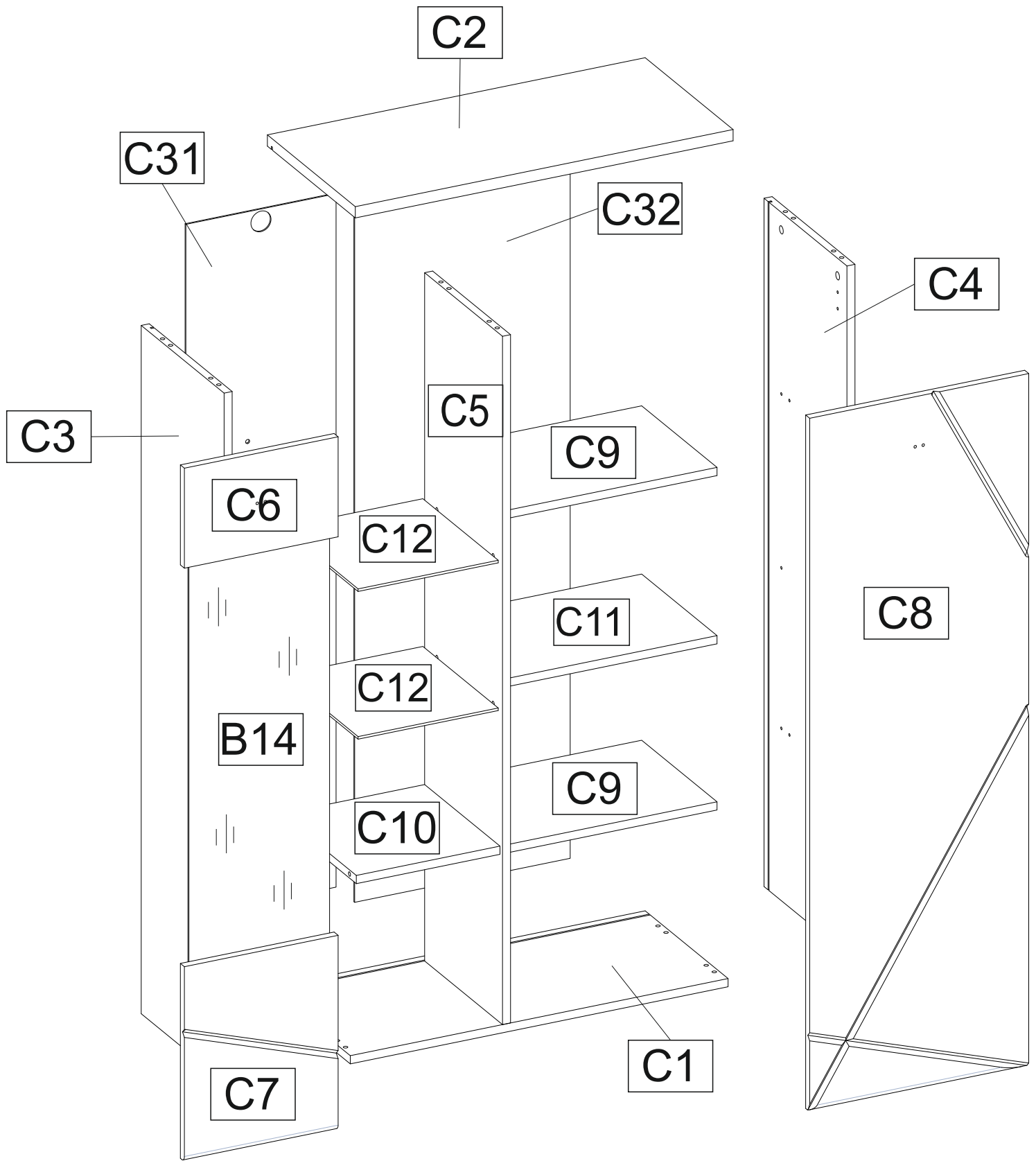

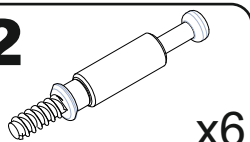
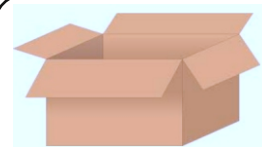
1**2****C2****752x350**

Colli nr 2

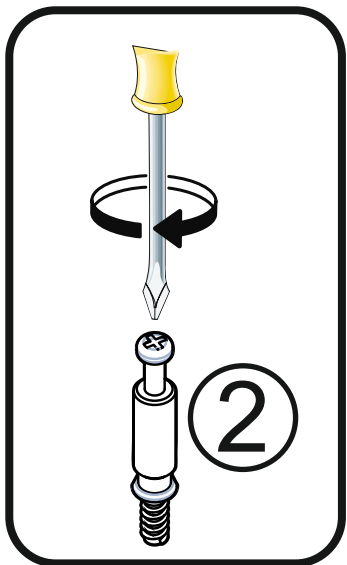
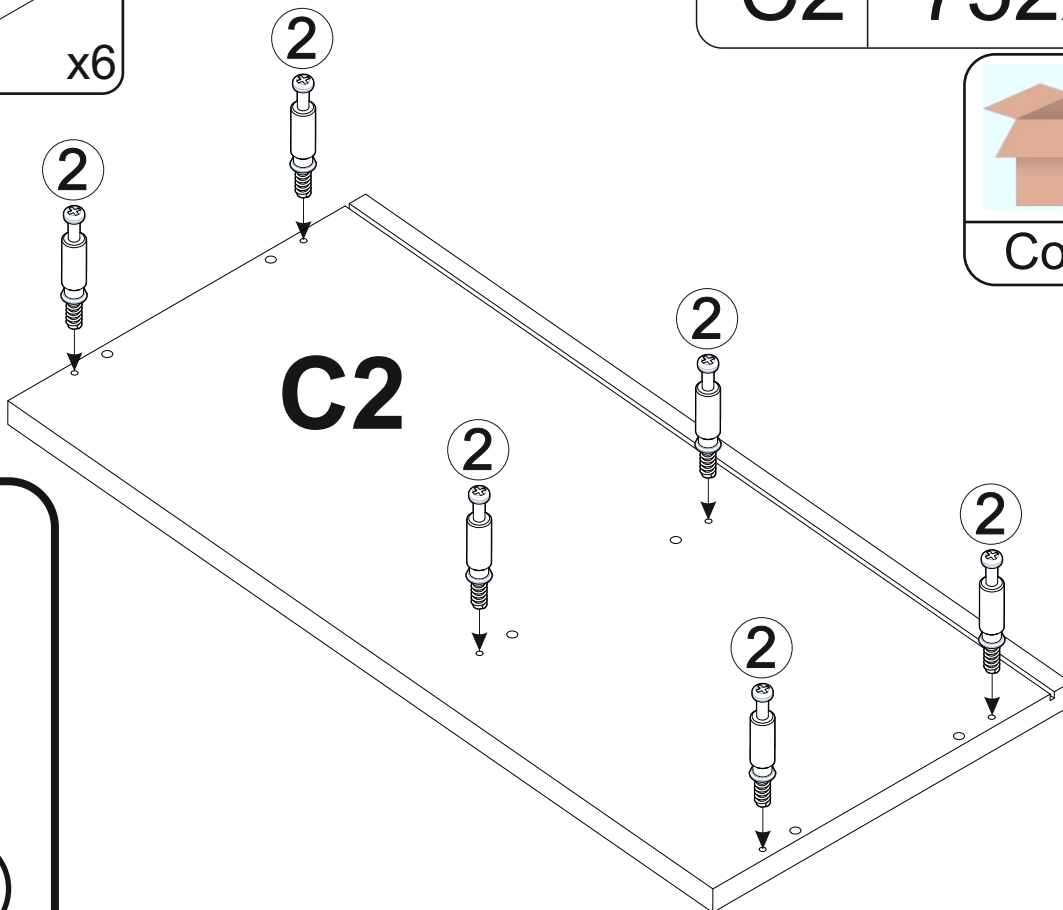
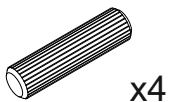
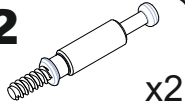
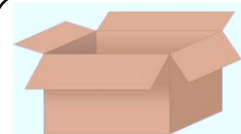
**2****1****2****54****9****C3****1342x330**

Colli nr 3

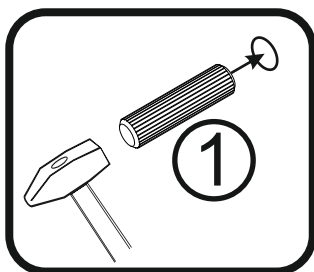
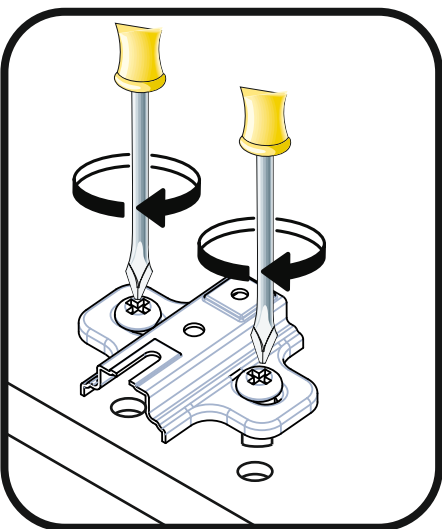
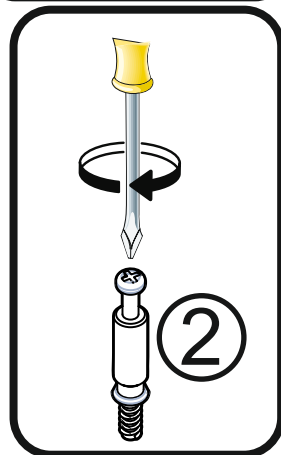
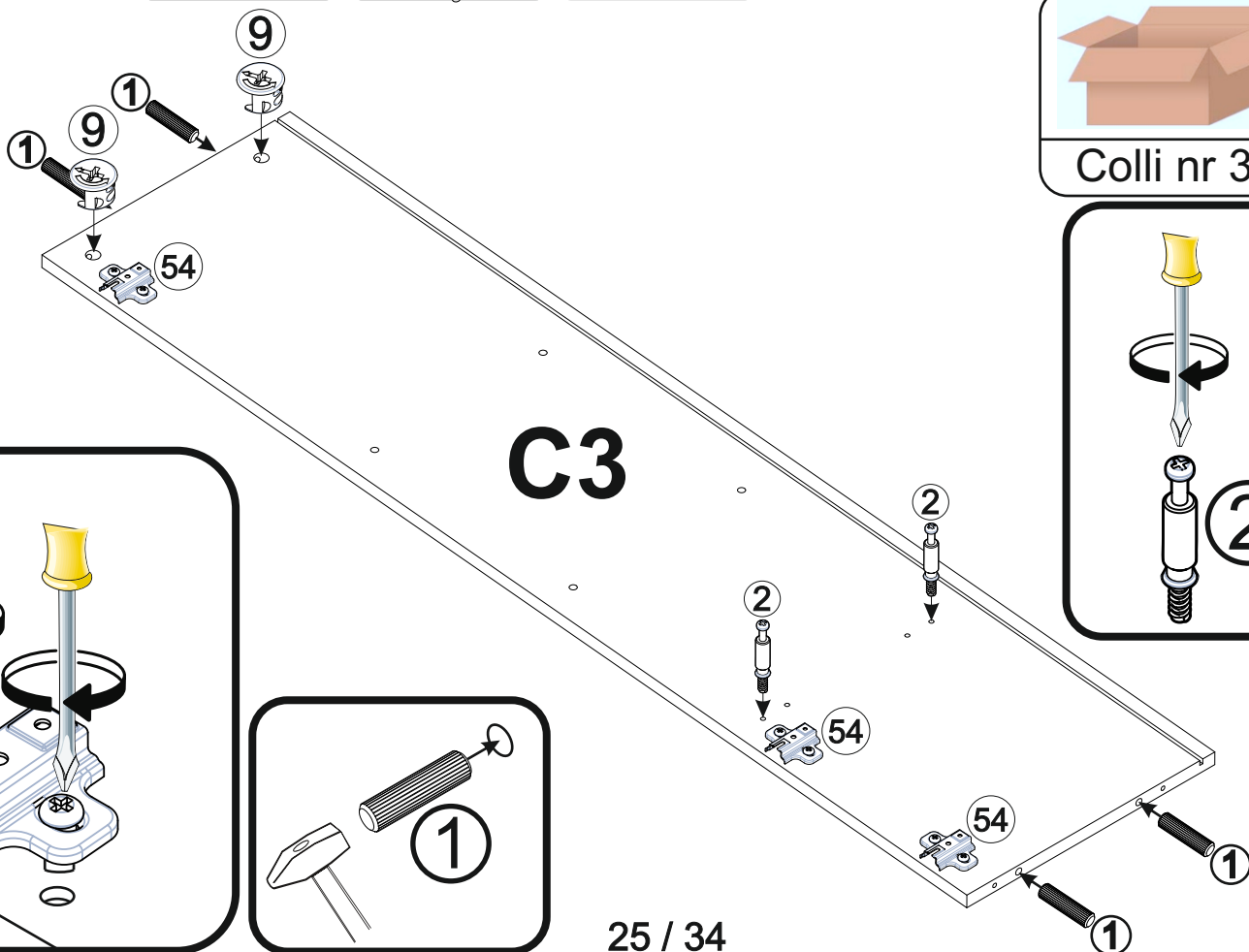

3

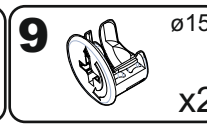
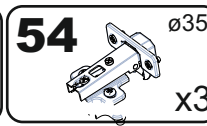
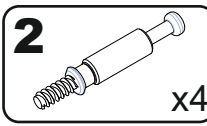
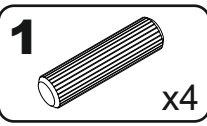

C4

1342x330

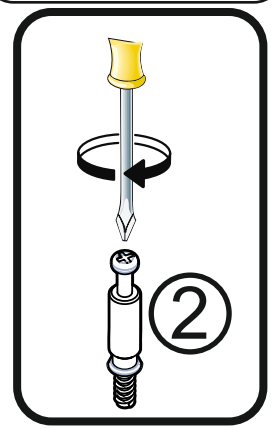
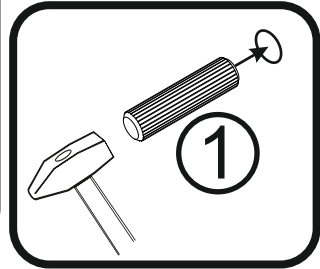
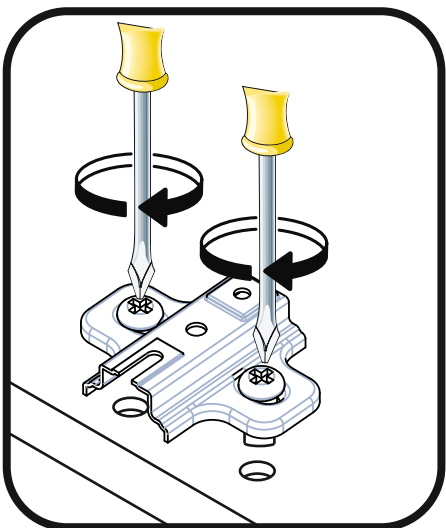
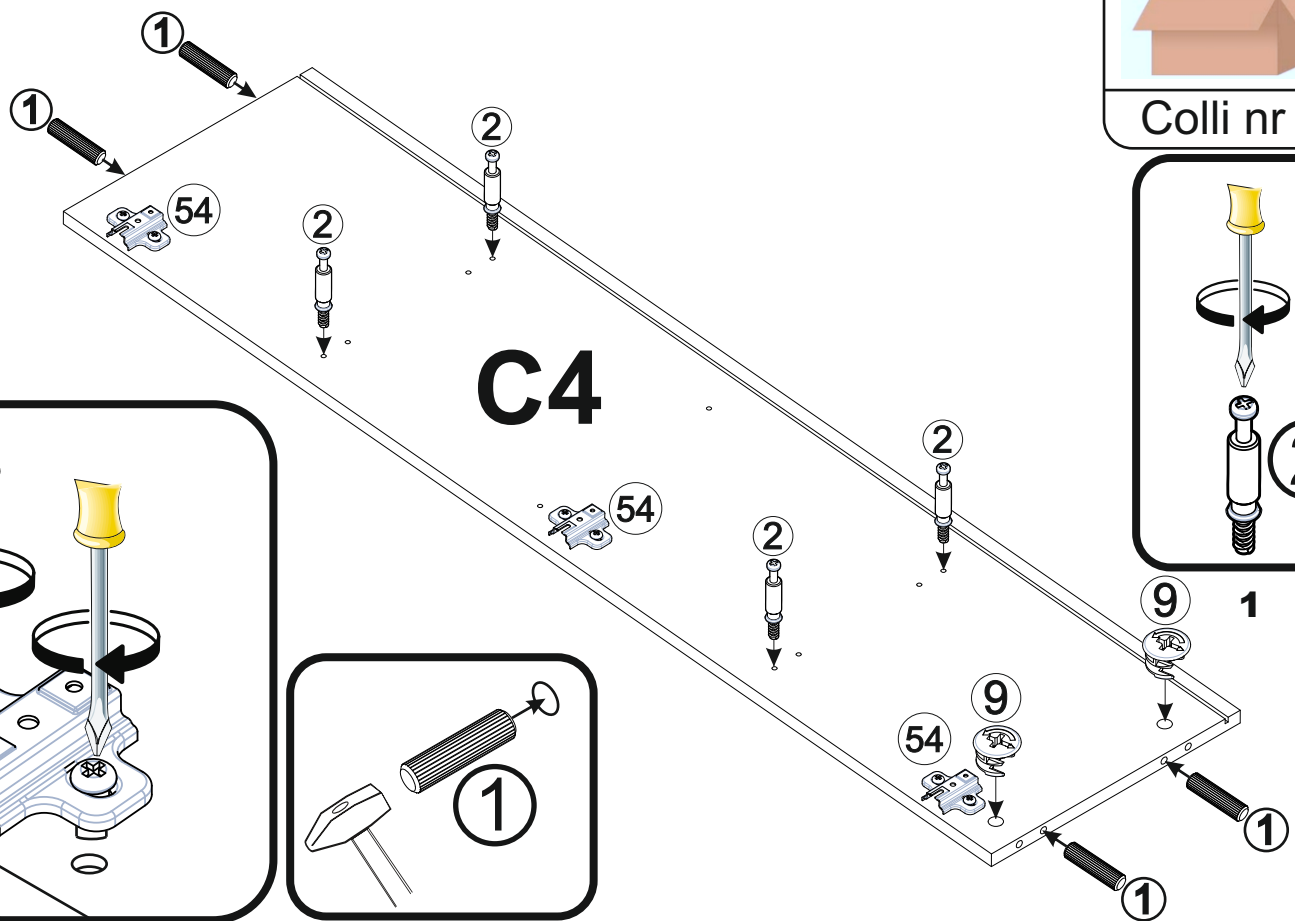
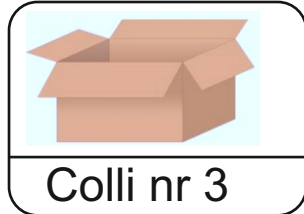

4

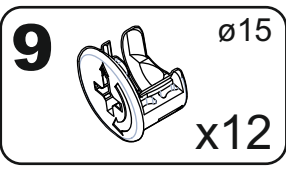

C9

416x300

C10

286x300

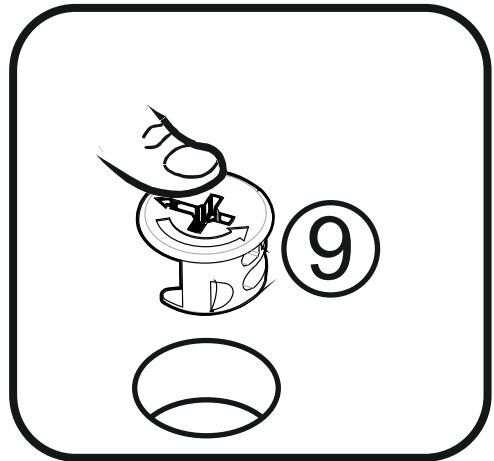
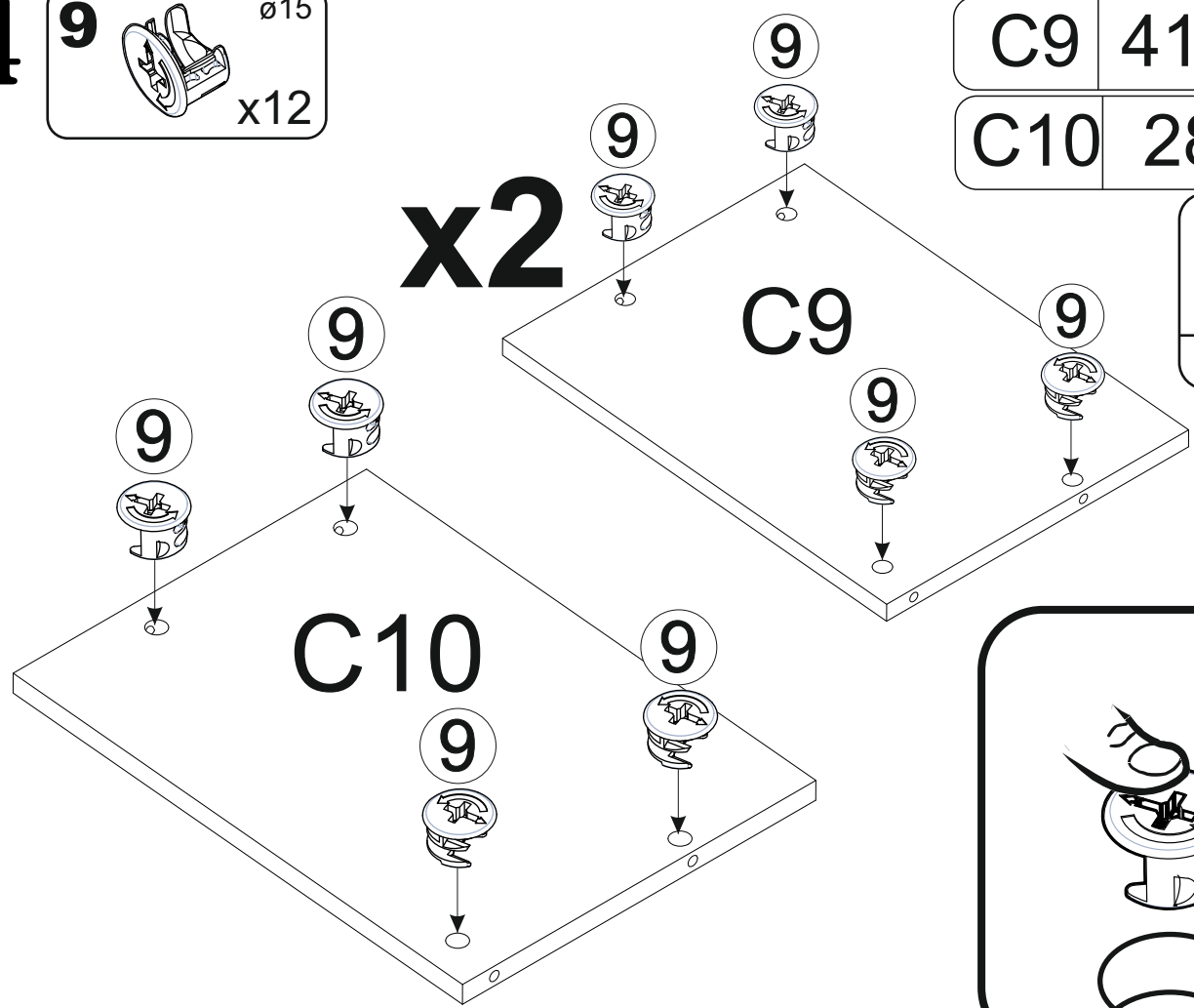
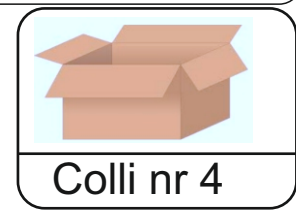

5

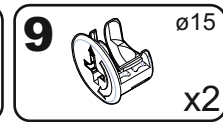
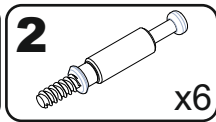
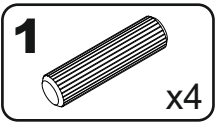

C5 1342x310

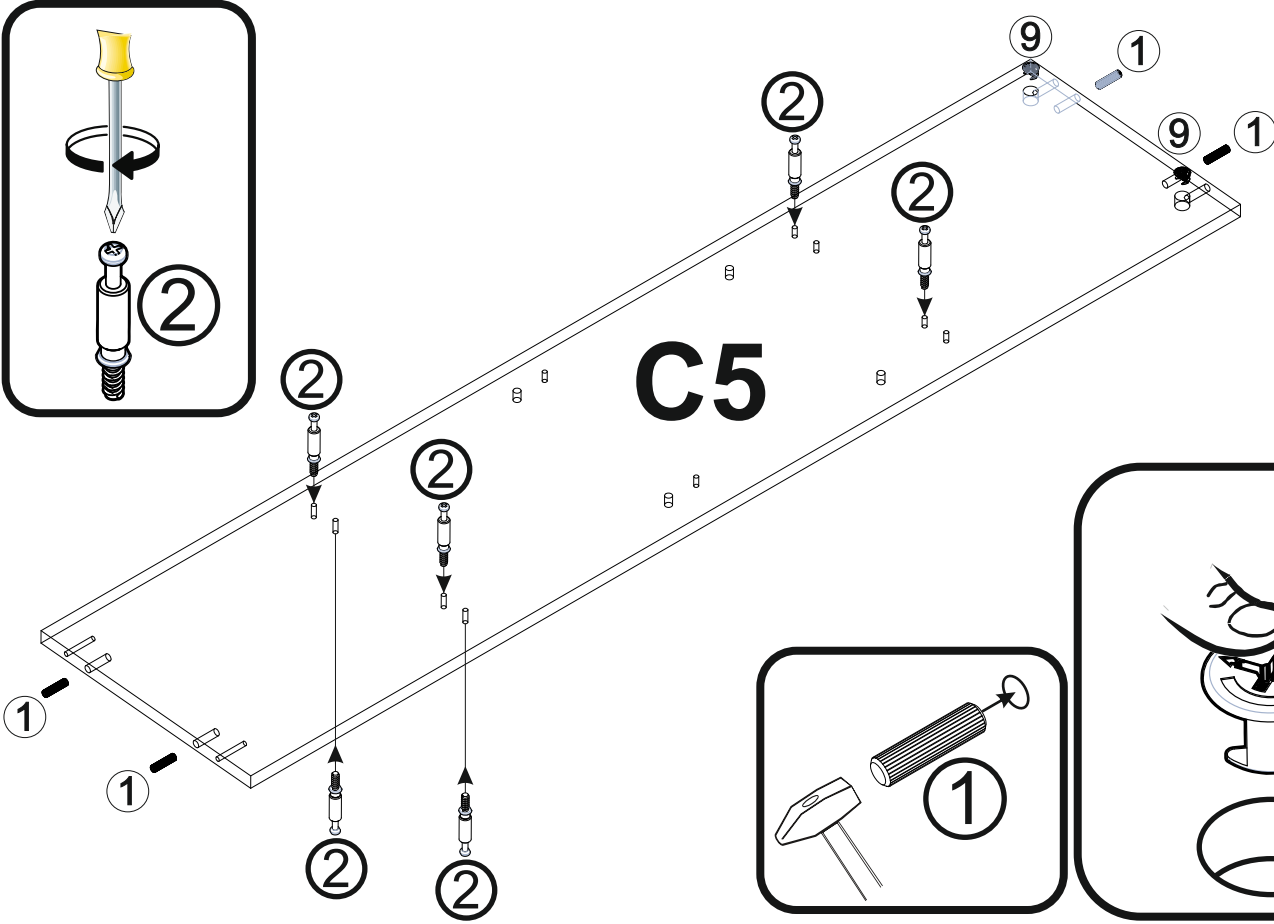
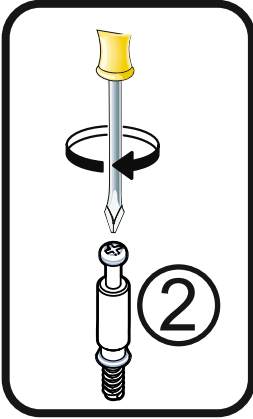
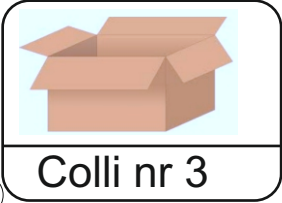

C5

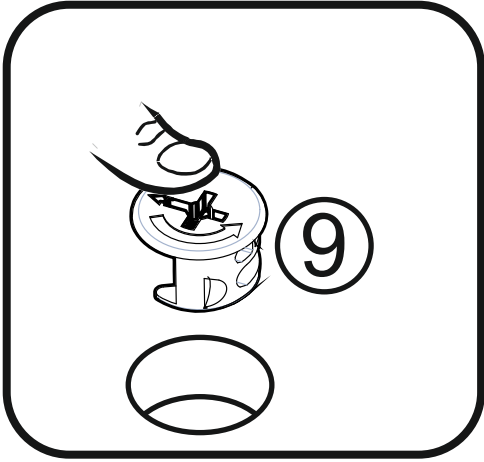
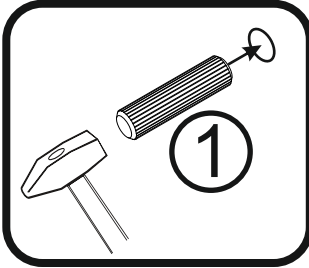

6

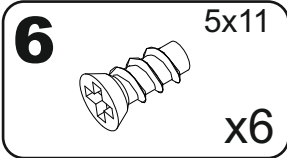
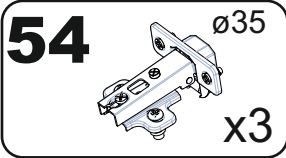

C8 1352x436

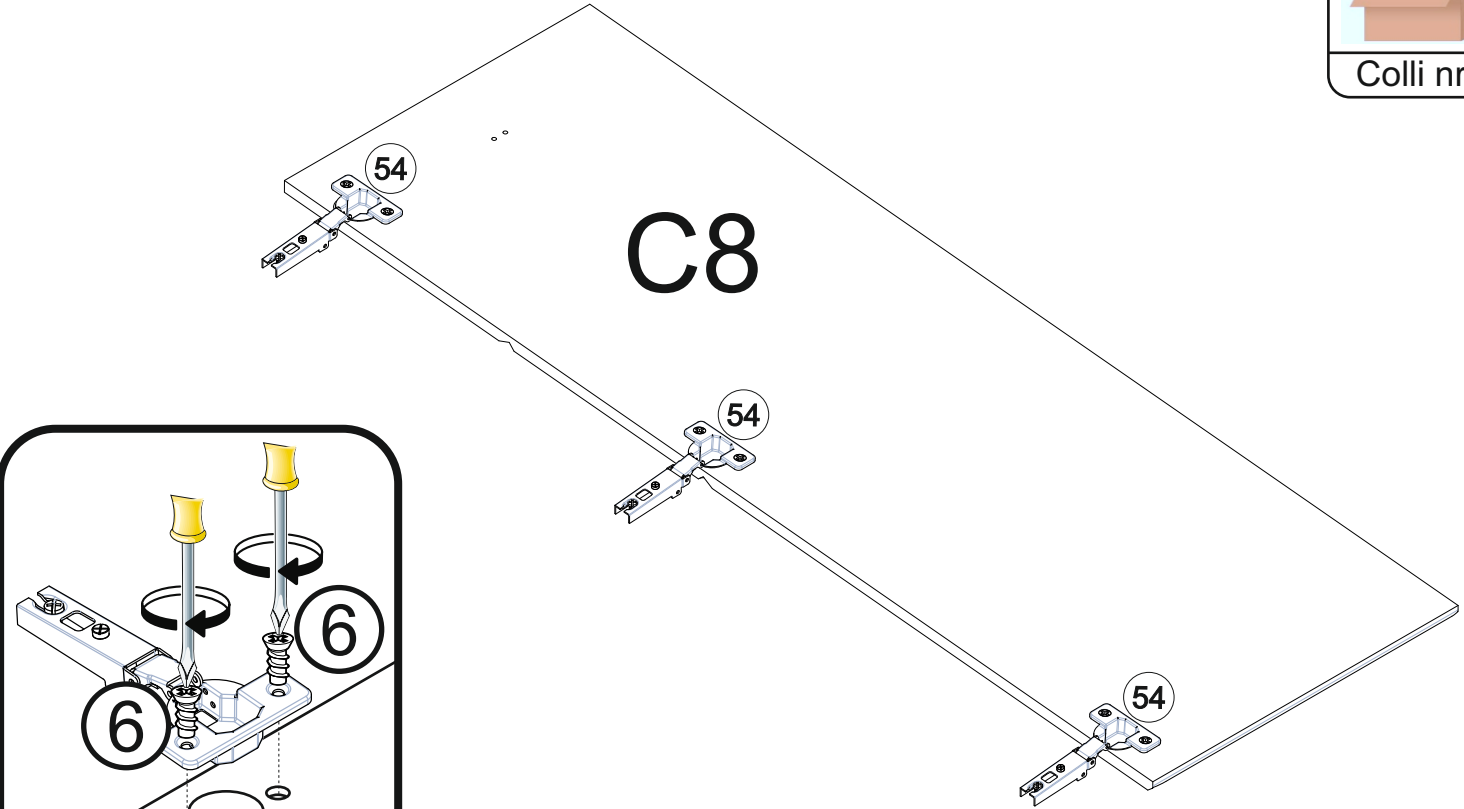
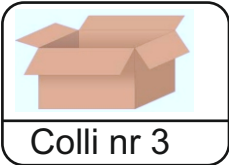

C8

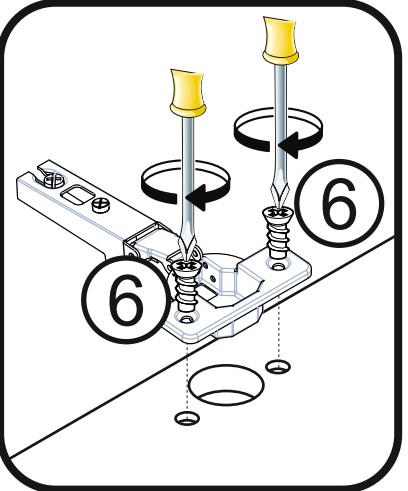

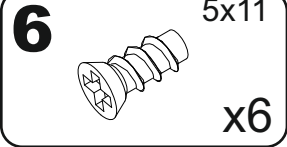
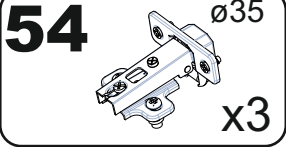
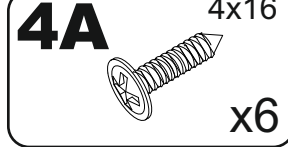
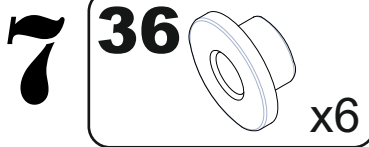

C6 306x195

C7 306x380

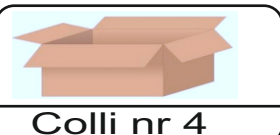

B14 838x280

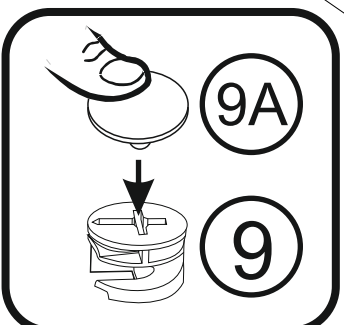
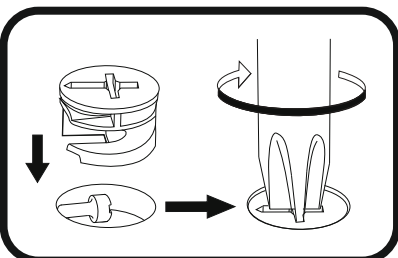
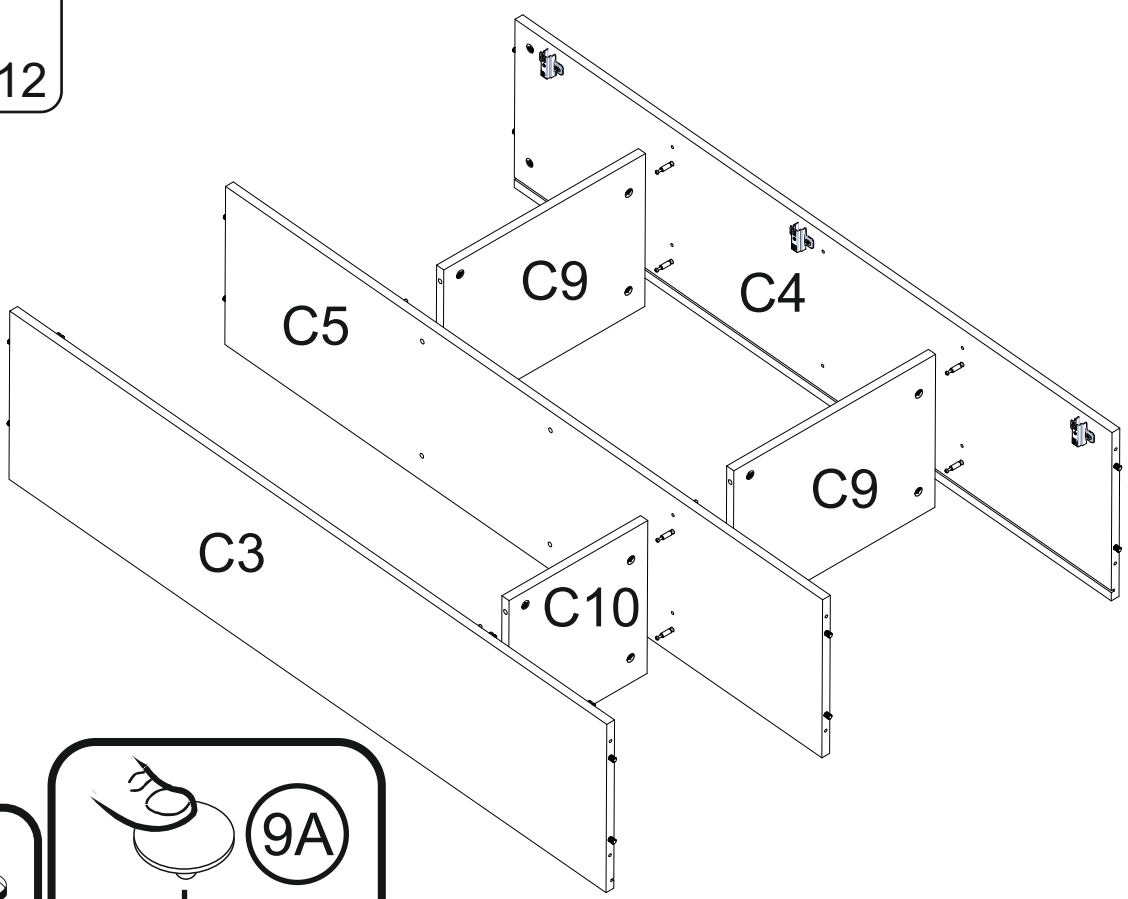
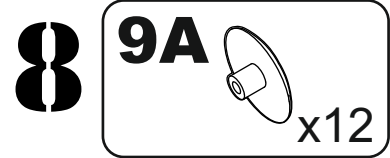
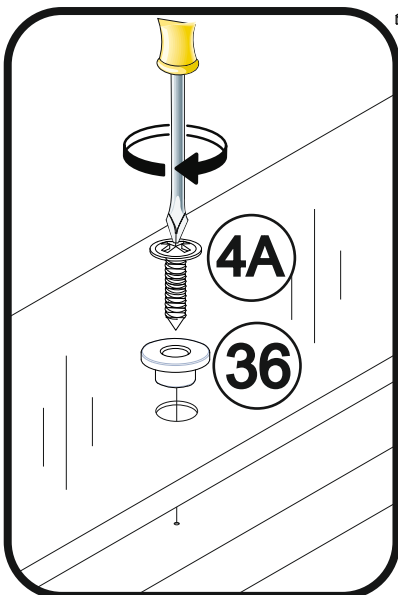
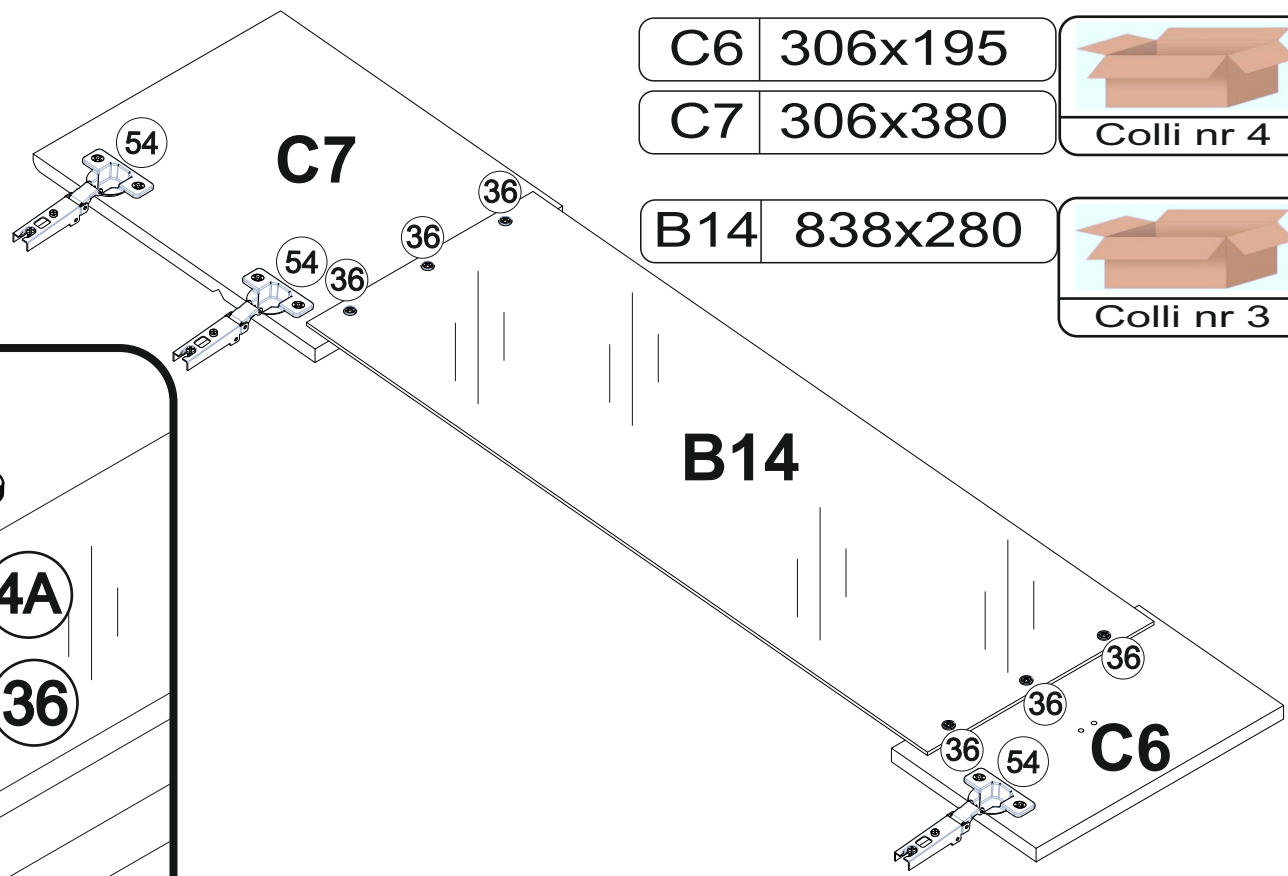
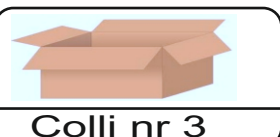

9

22



x6

22A



x6

C1

752x330

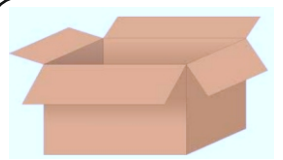

Colli nr 4

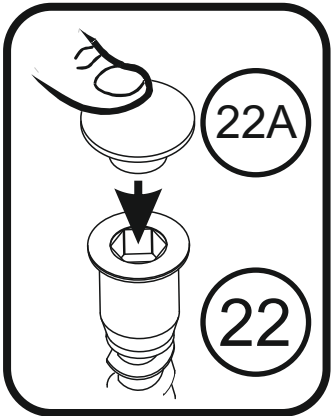
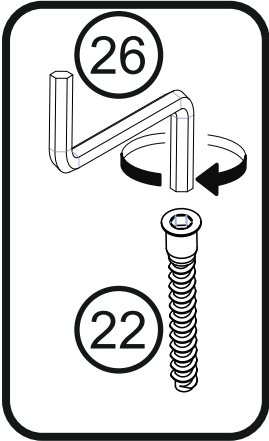
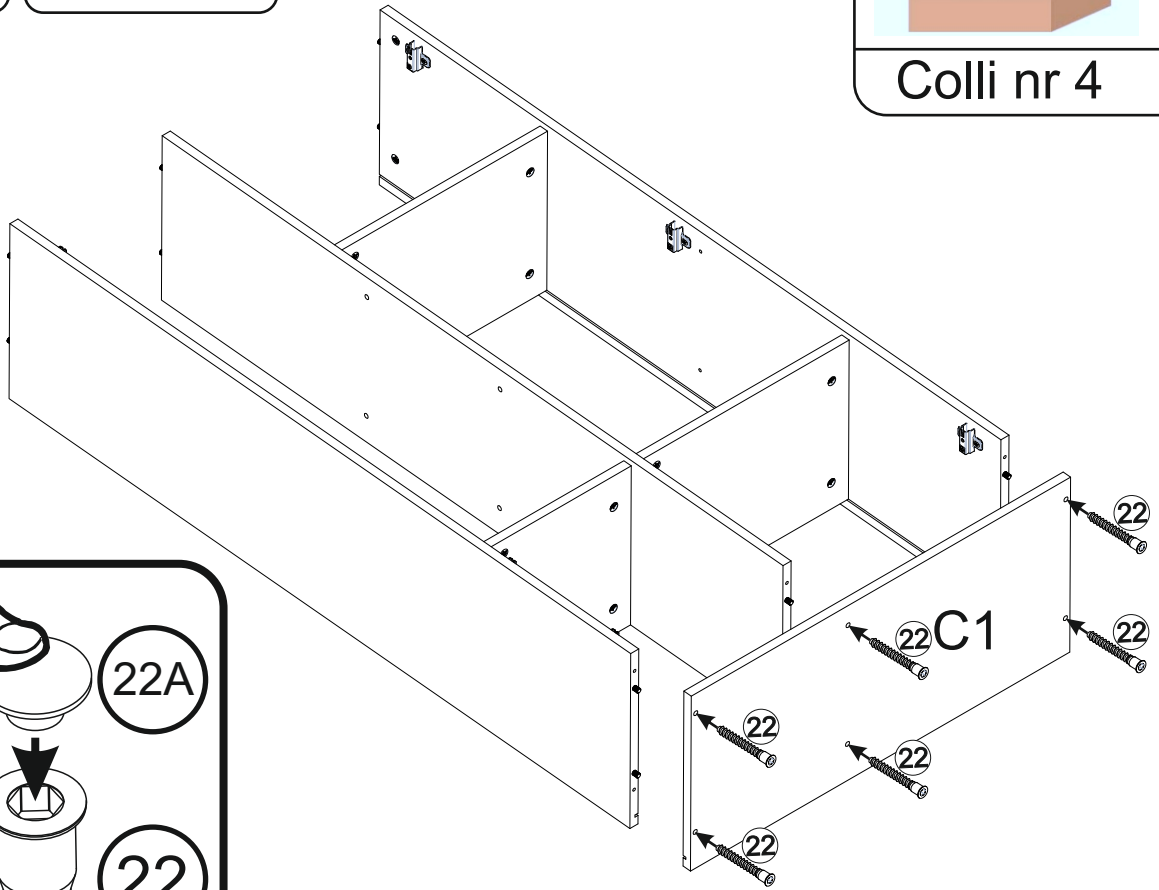

10

C31 1352x299

C32 1352x429

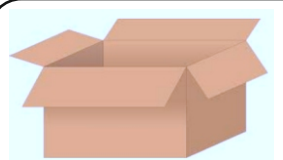

Colli nr 3

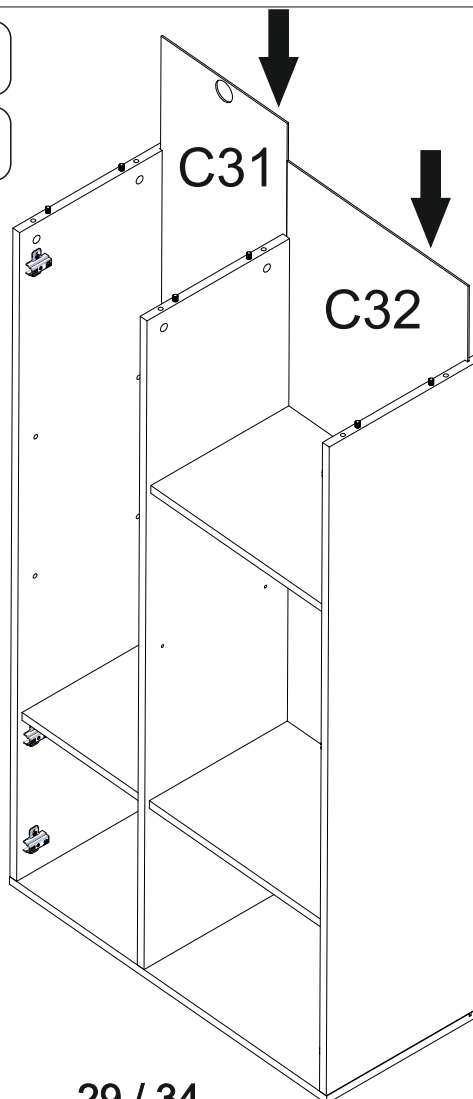

11

9A



x6

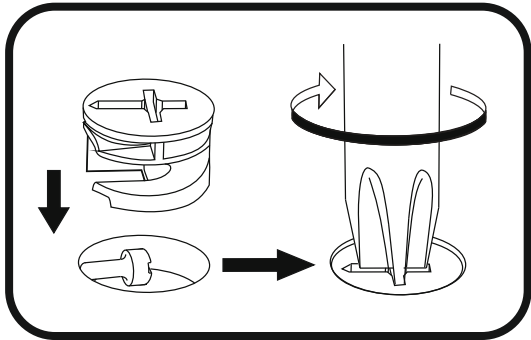
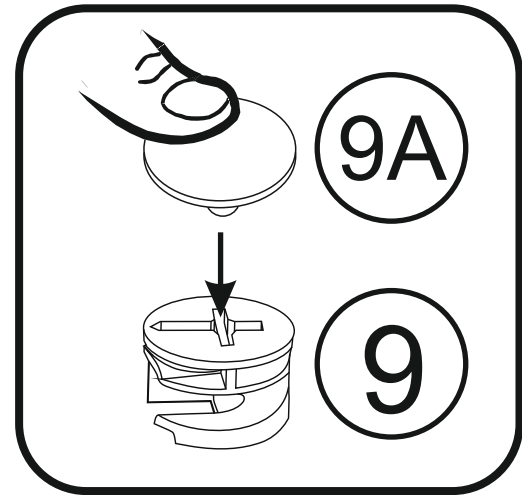
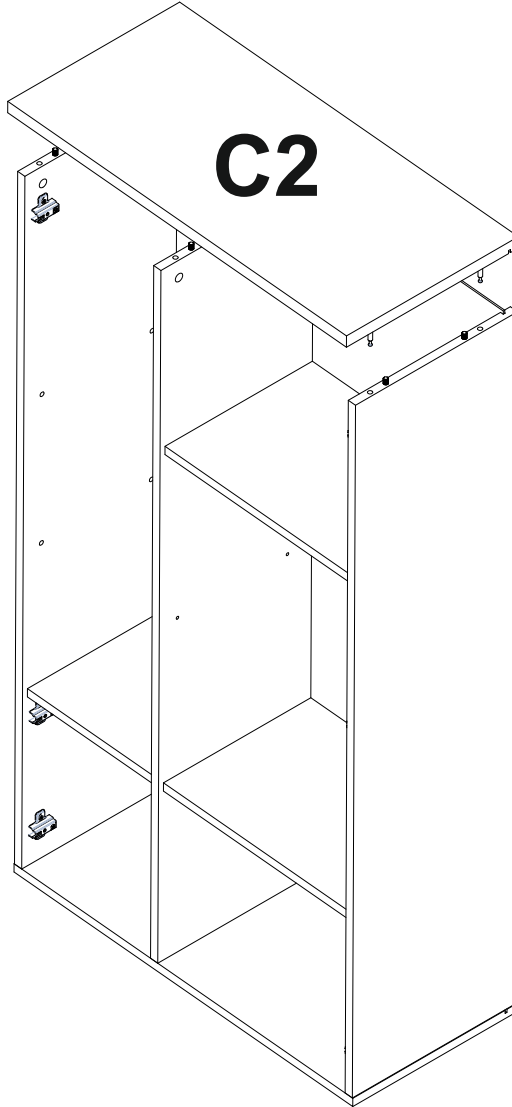

12

35

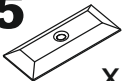

x13

38

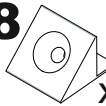

x14

39



3x20

x27

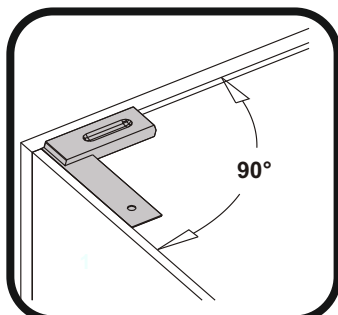
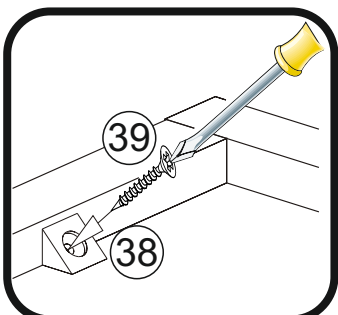
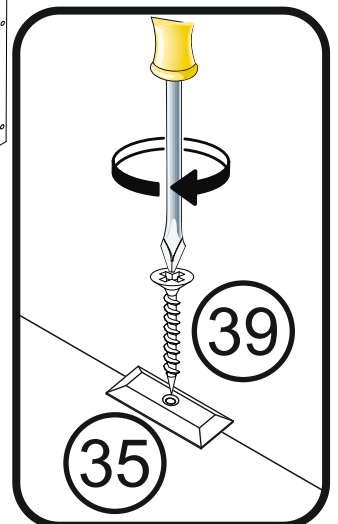
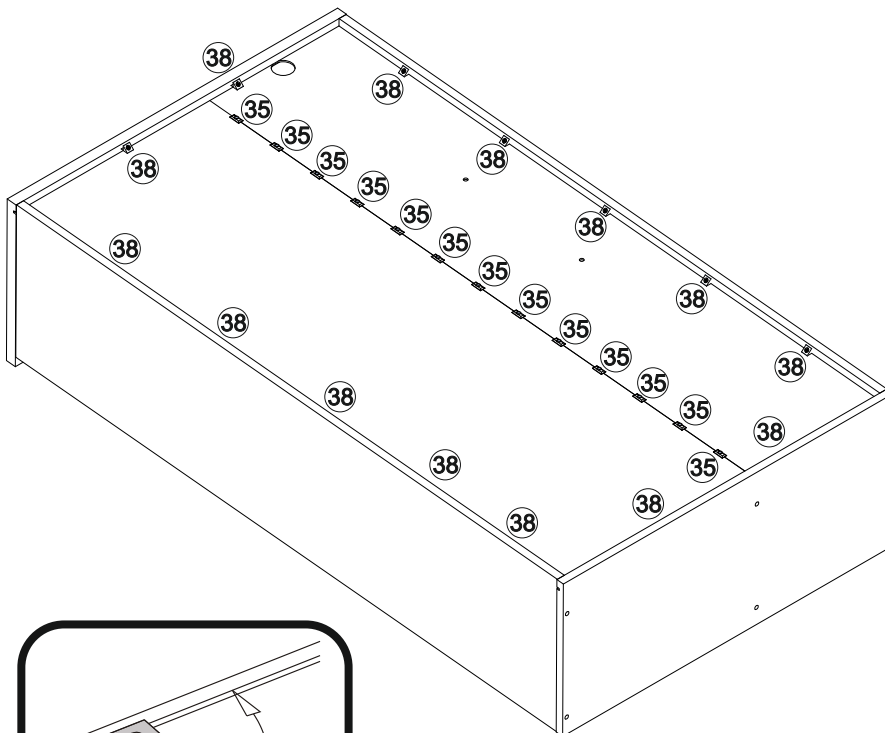

13

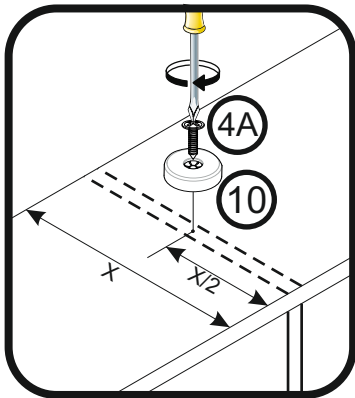
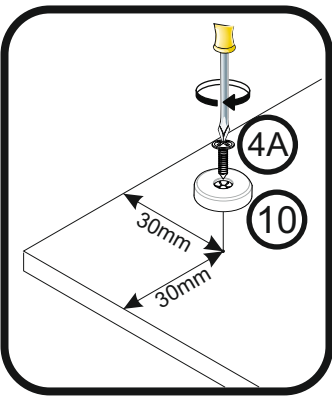
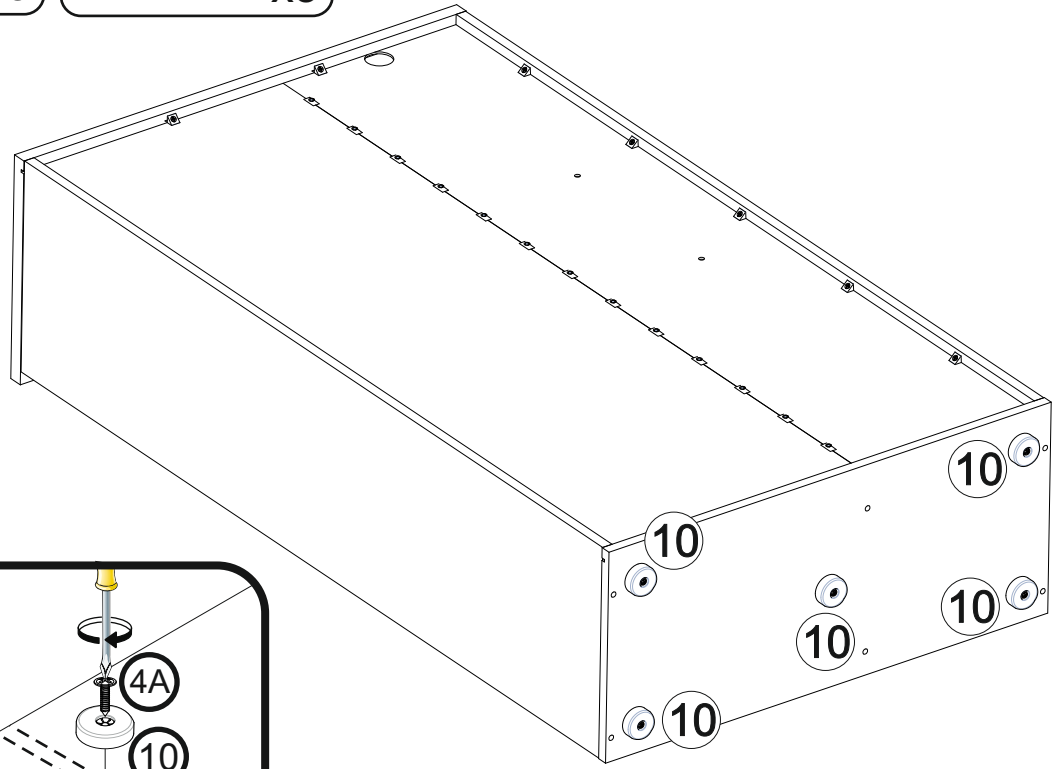
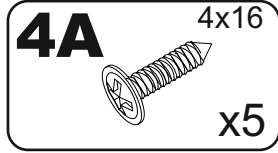
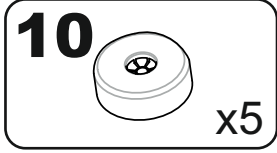

14

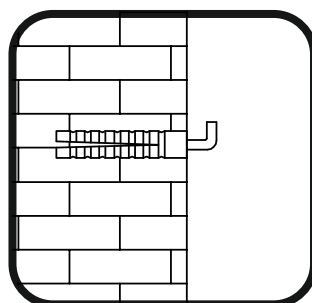
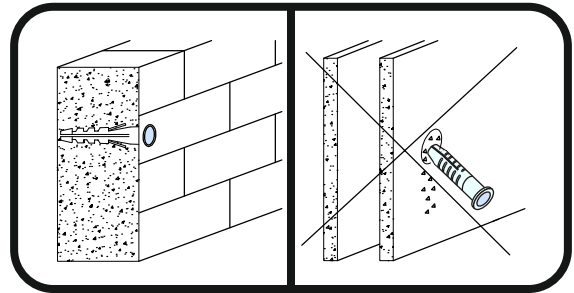
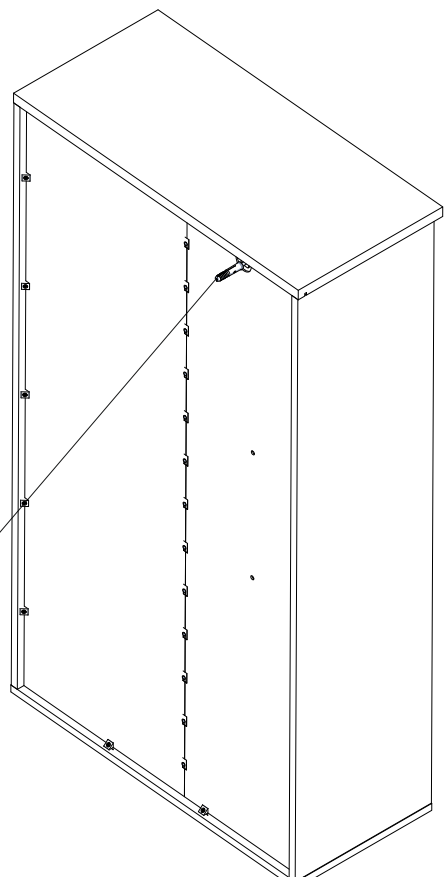
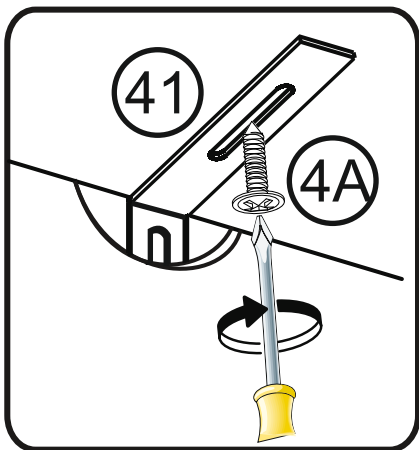
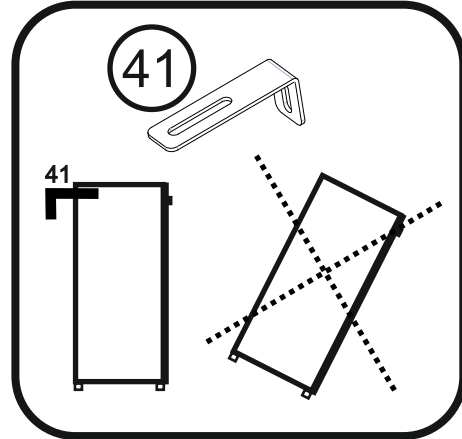
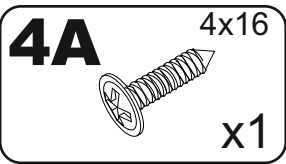
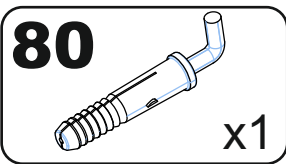
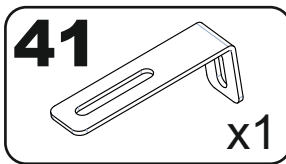

15

13

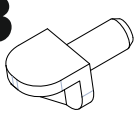

x4

14

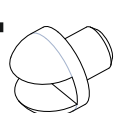

x8

C11

416x300

C12

279x300

x2

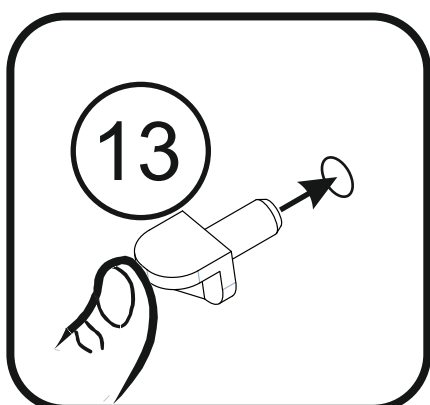
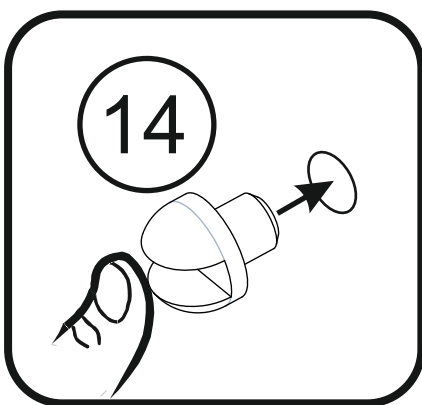
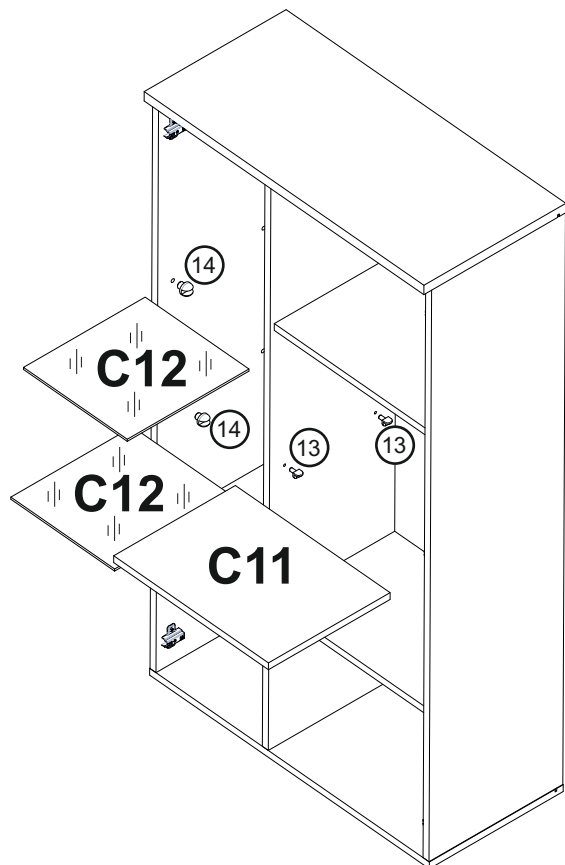
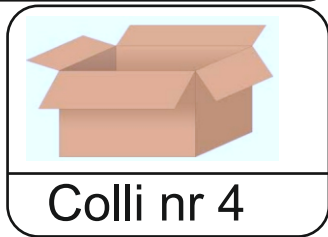

16

3

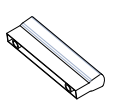

x2

4

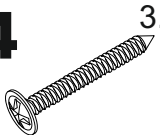

x4

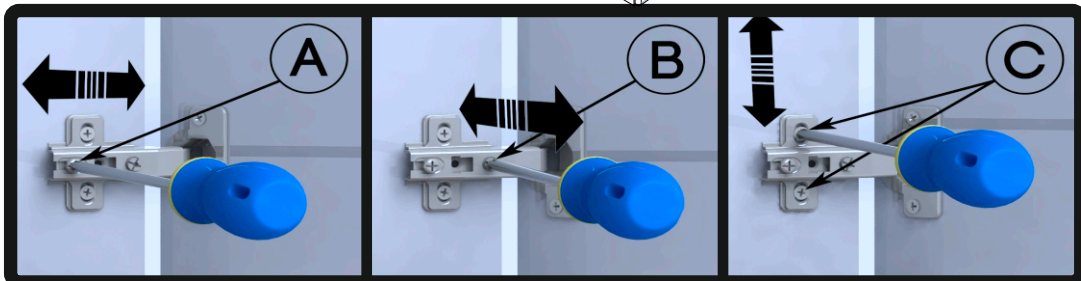
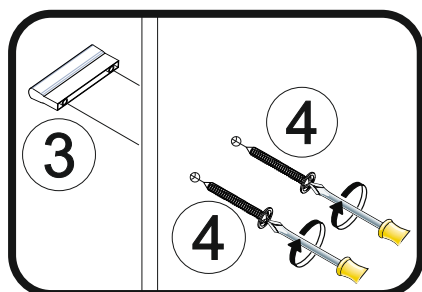
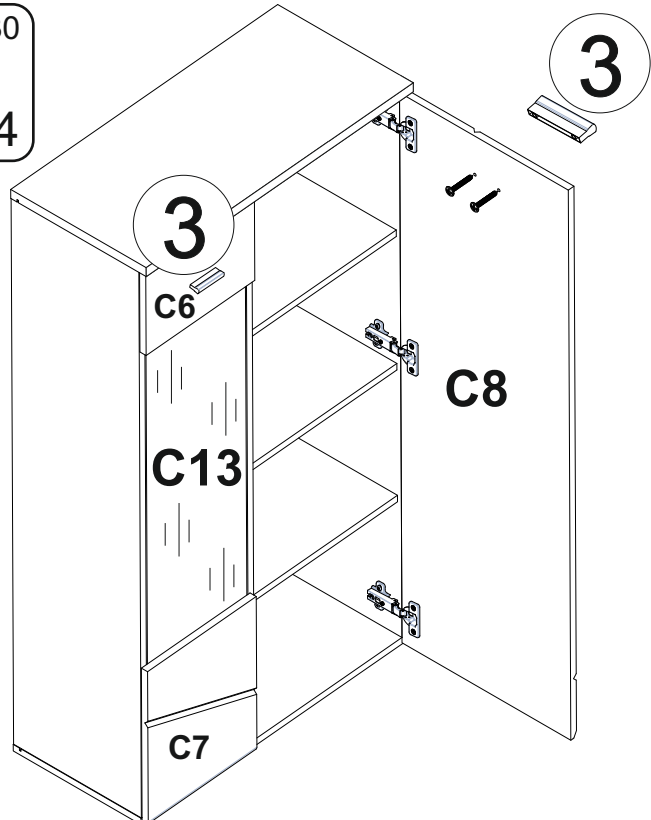

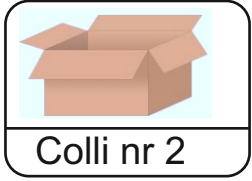
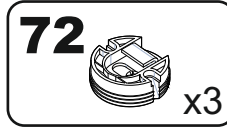
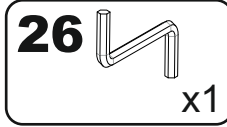
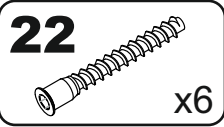
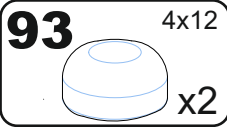
1

N1 1600x195

N2 1594x195

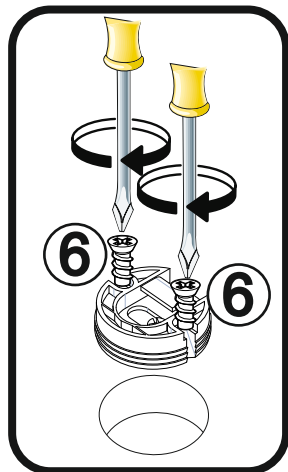
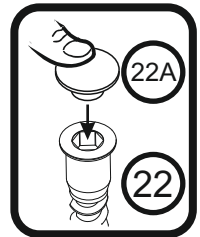
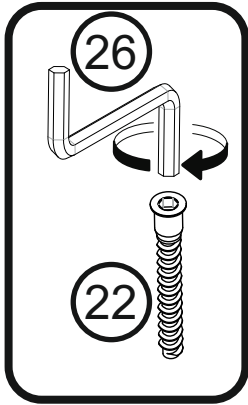
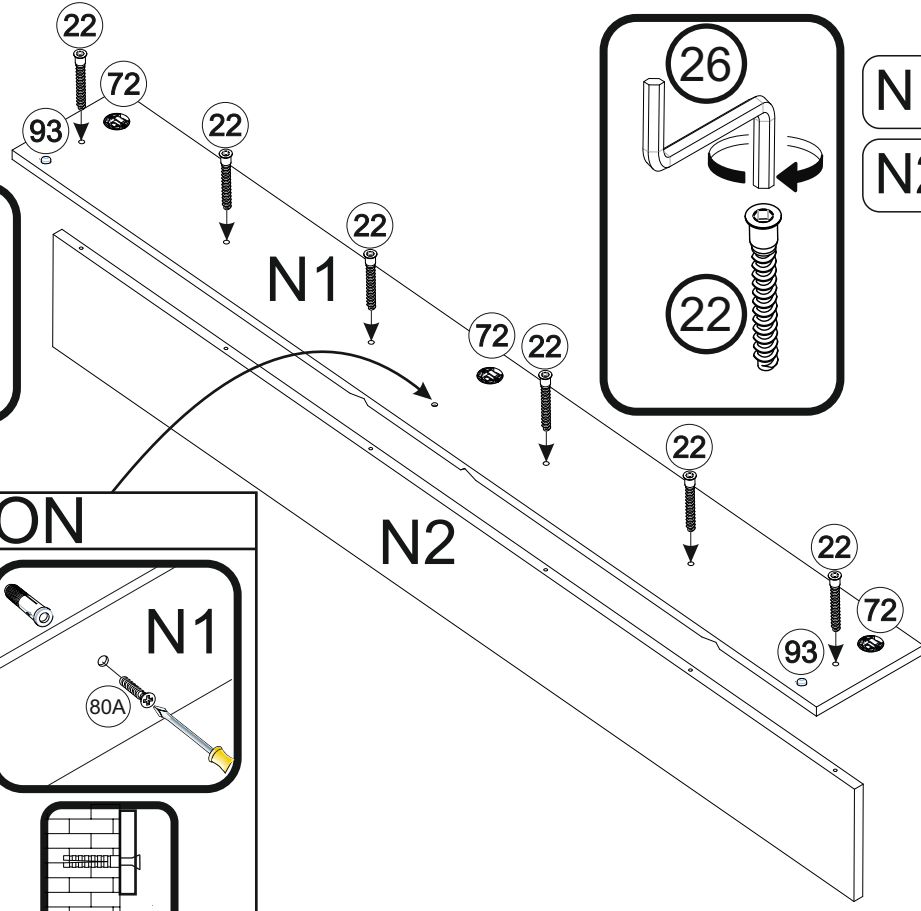
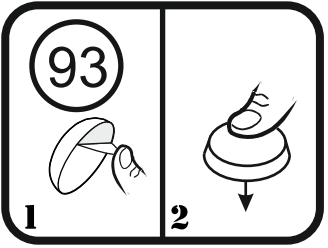

OPTION

N1

80A

8

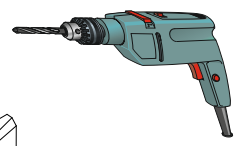
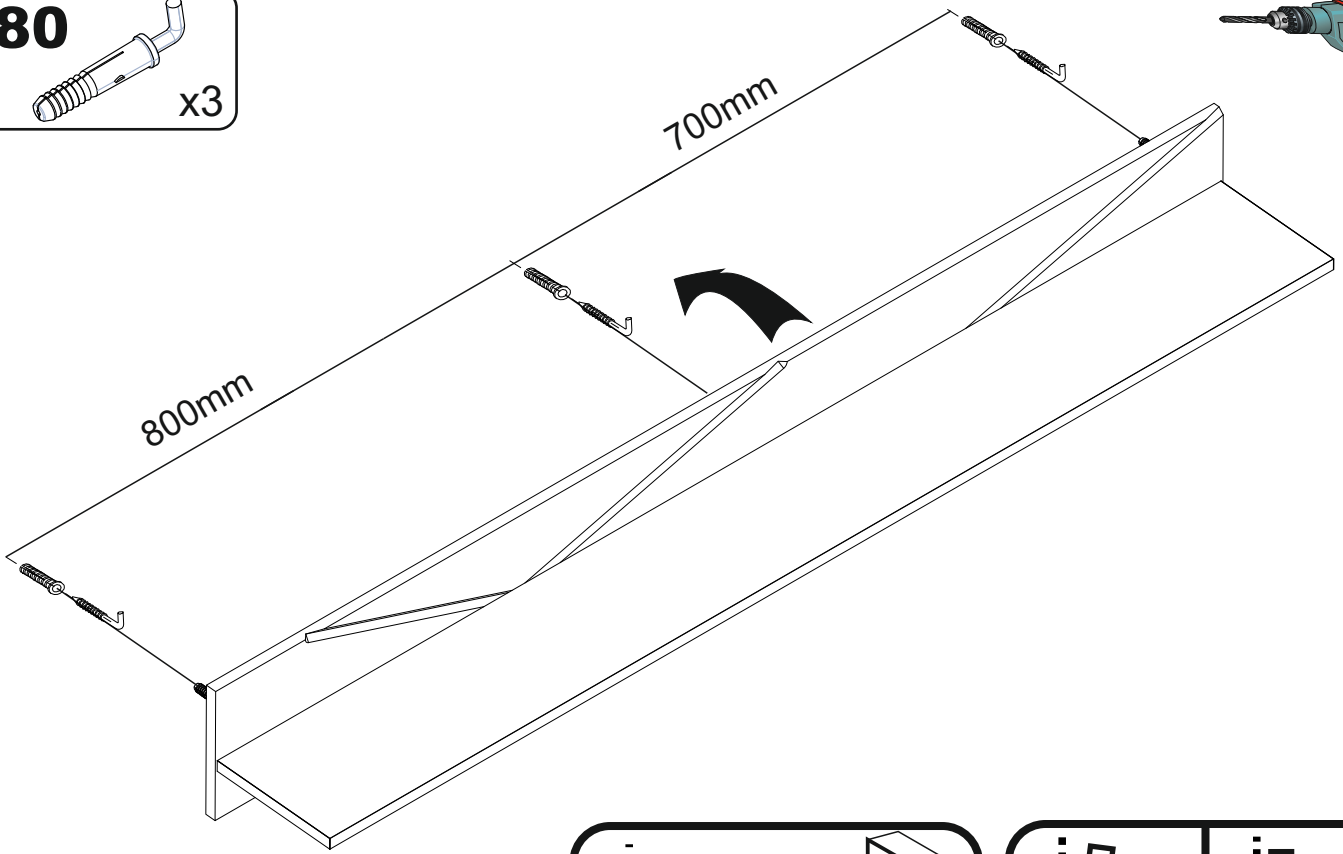
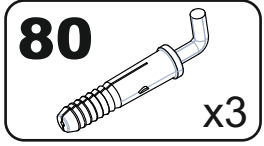
2

33 / 34

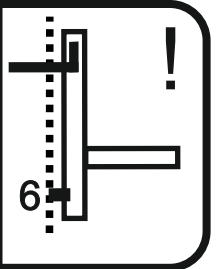
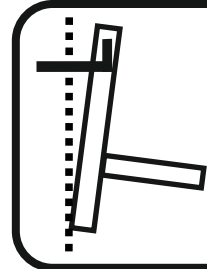
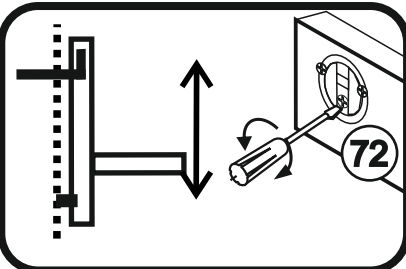
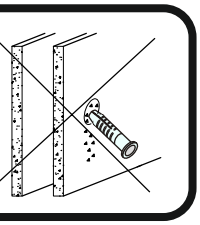
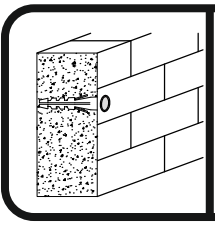
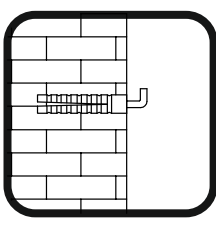

ATTENTION!!!

Do not clean doors for 7 days after removing protection foil.
Foiled parts needs 7 days without protection foil to become tough.

