

Montageanleitung / Assembly Manual
Hängelampe / Pendant Lamp

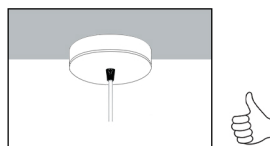
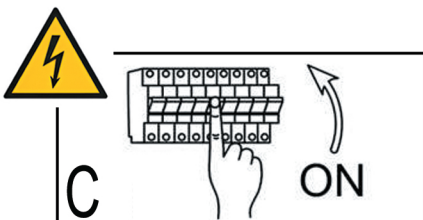
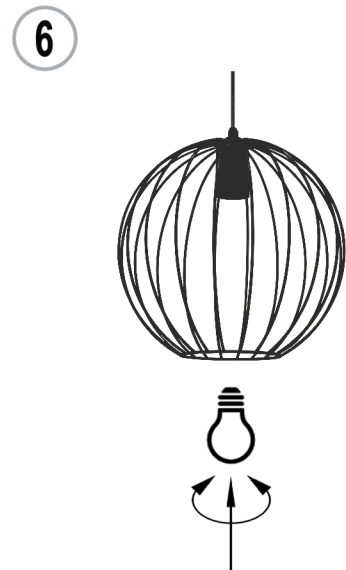
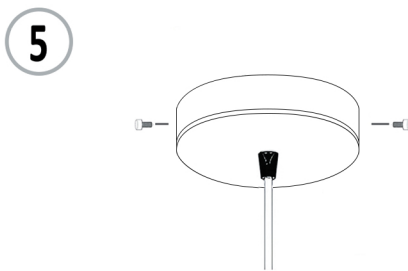
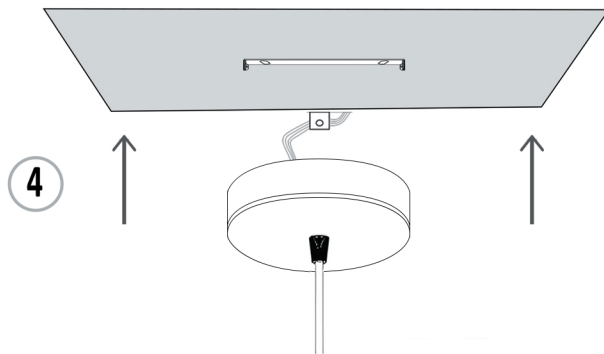
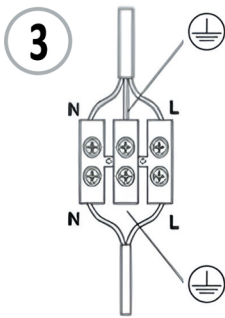
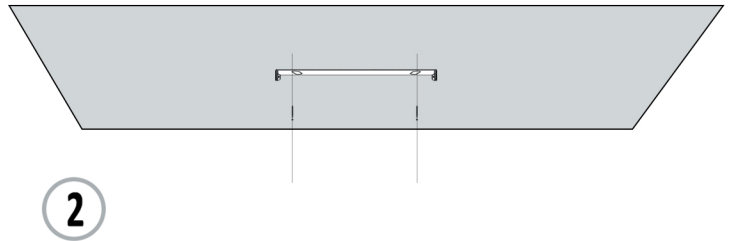
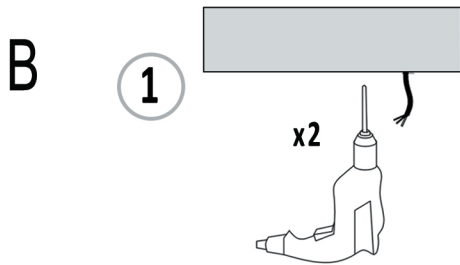
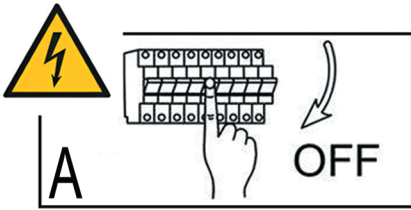
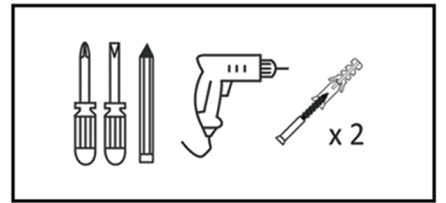

MERCURE

W-KM 1388L/1 BK-B

HELAM
lighting



1xE27 MAX 15W LED / 230V - 50Hz

Material: Metall / Material: Metal

Farbe: Schwarz / Colour: Black

Abmessungen / Dimensions: 300mm x 300mm x 1100mm

Gewicht / Weight: 1,2kg

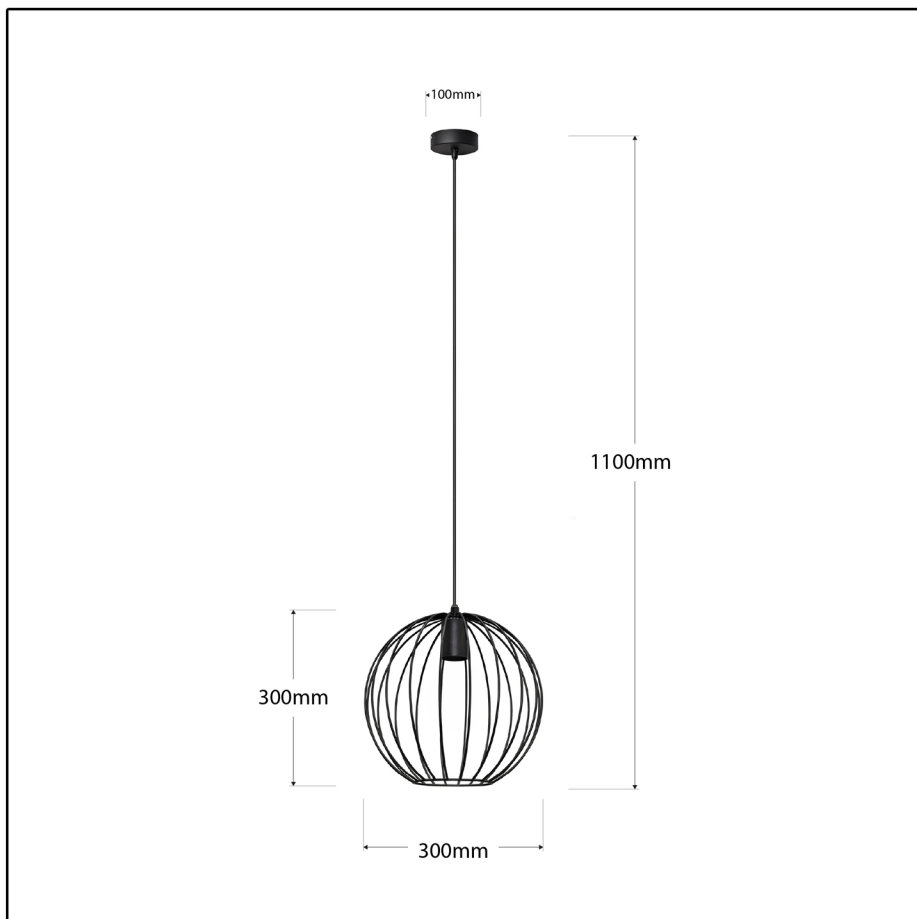

IP20



CE



W-KM 1388L/1 BK-B