





# Camargo 2,5



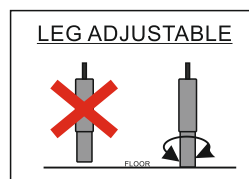
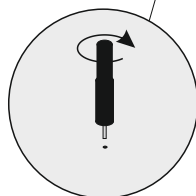
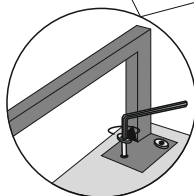
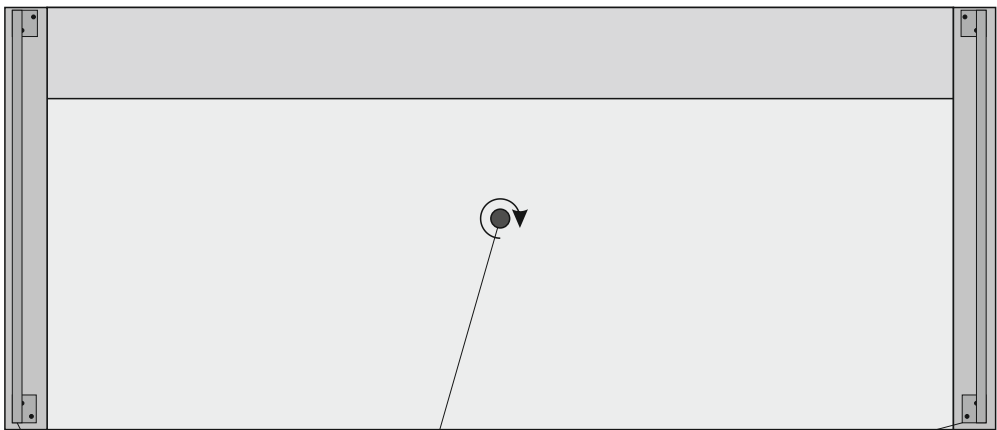
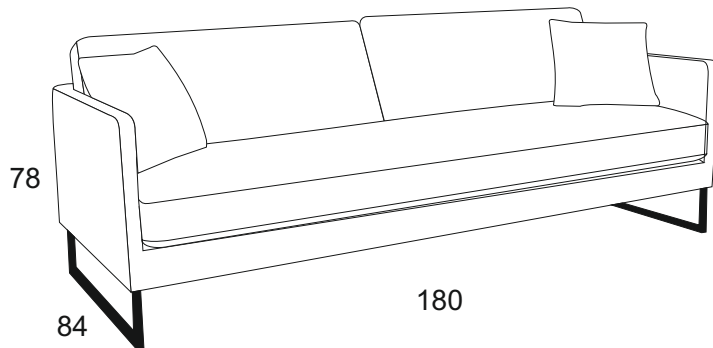

No.

 - 15min	 2x-IMP-0042 L-770	 1x - H-160-200mm	 8x - 8x35	 1x - 5B
--	--	---	--	--



# Camargo 2



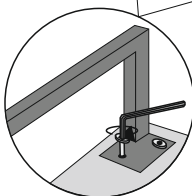
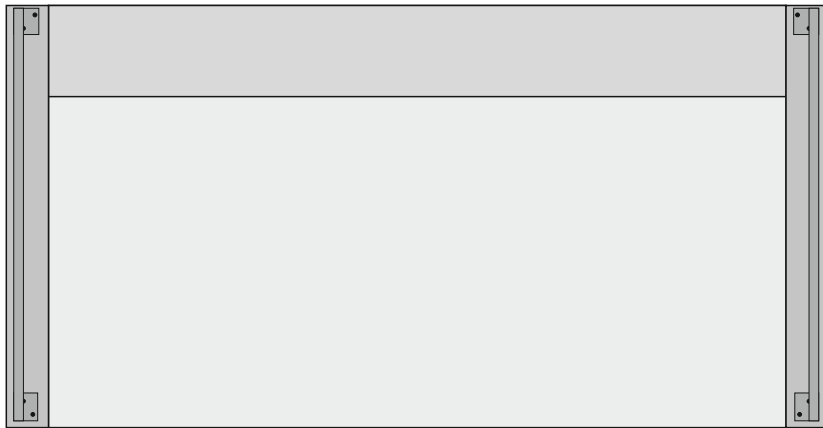
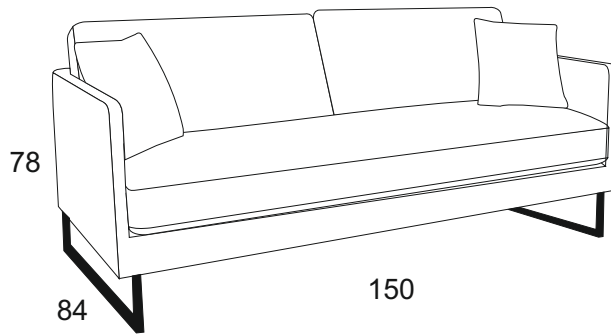

No.

 - 15min	 2x-IMP-0042 L-770	 8x - 8x35	 1x - 5B
--	--	--	--



# Camargo 1,5



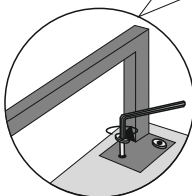
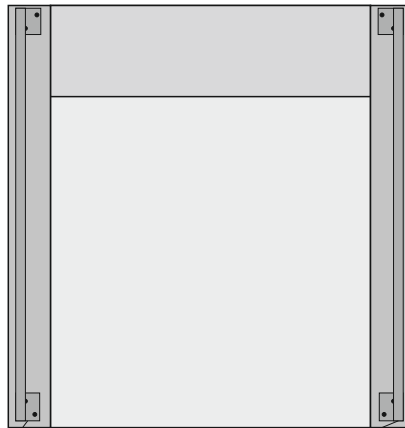
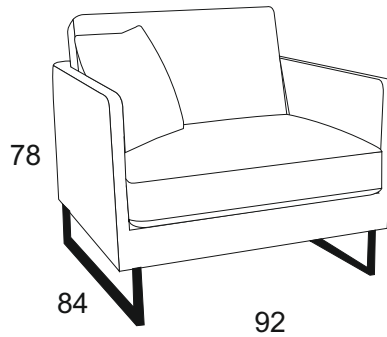

No.

 - 15min	 2x-IMP-0042 L-770	 8x - 8x35	 1x - 5B
--	--	--	--



# Camargo 1

No.

 - 15min	 2x-IMP-0042 L-770	 8x - 8x35	 1x - 5B
--	--	--	--

