

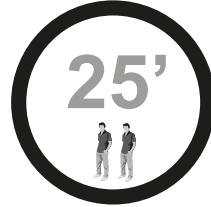

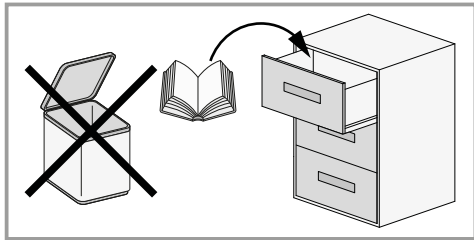

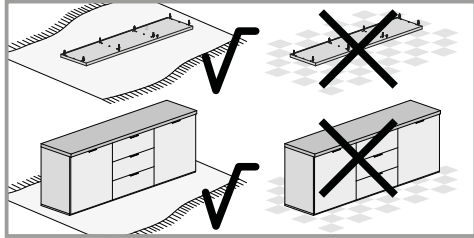

Schreibtisch



Brera

-  **D** Montageanleitung
-  **GB** Assembly instructions
-  **I** Istruzioni di montaggio
-  **F** Notice de montage
-  **NL** handleiding voor de montage

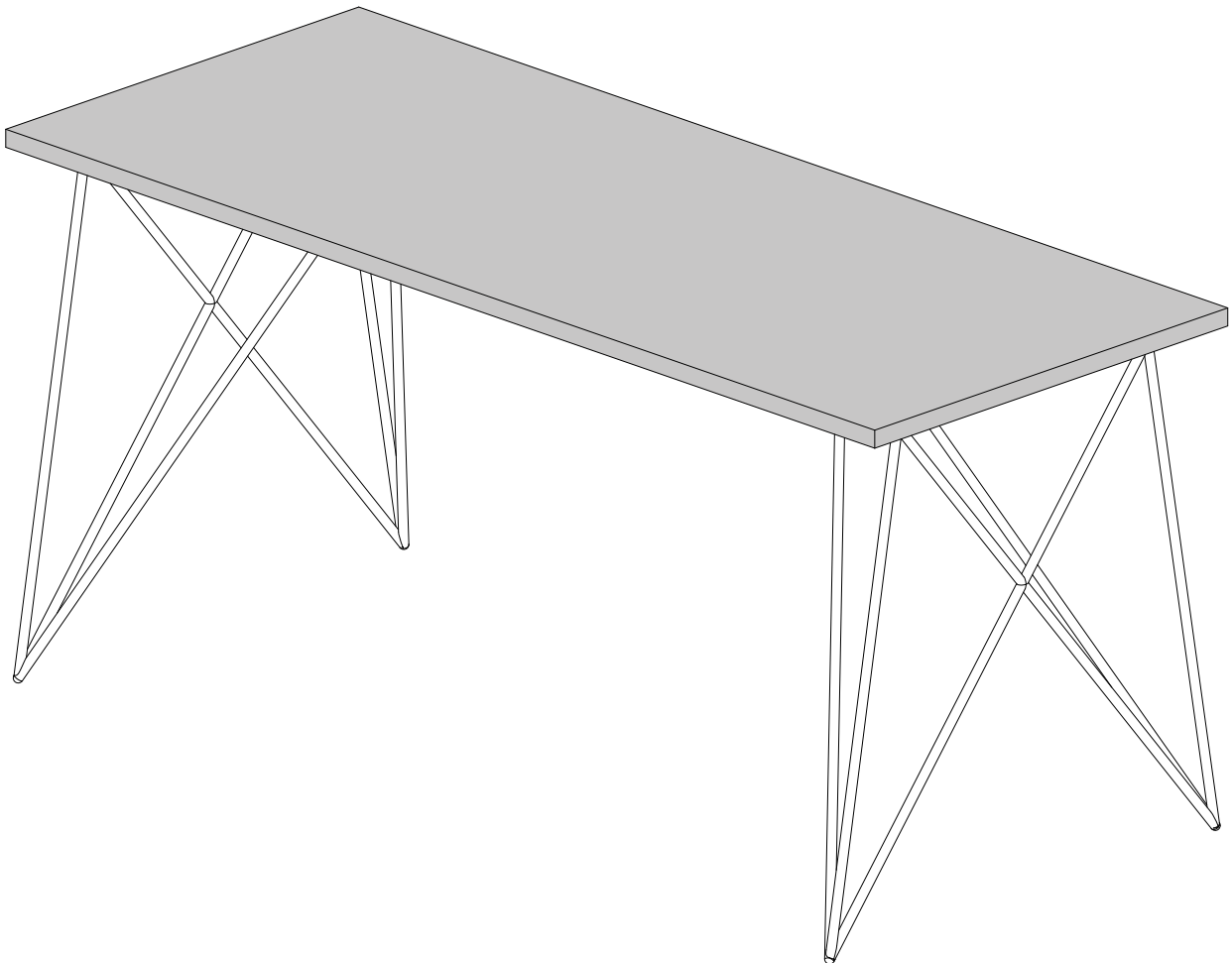

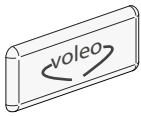
L19**n.1****F48**

M6x15mm

n.8**12****D Sicherheitshinweise**

Das Dreieck erinnert Sie während der Montage an die folgenden Hinweise. 

1 Fachkundige Montage erforderlich. Unsachgemäße Montage kann zu Unfällen führen. Da es viele verschiedene Wandmaterialien gibt, sind Schrauben für die Wandbefestigung nicht beigelegt. Ggf. sollte man sich beim Eisenwarenfachhandel nach geeignetem Befestigungsmaterial erkundigen.

12 Achten Sie darauf, daß Kinder keine Kleinteile, wie z. B. Muttern, Abdeckkappen oder Ähnliches in den Mund nehmen. Sie könnten sie verschlucken und daran ersticken.

13 Gehen Sie bei der Montage des Artikels sorgfältig vor und halten Sie sich an die Montageanleitung.

GB Safety instructions

The triangle reminds you during the installation of the following notes. 

1 Assembly must be carried out by qualified personnel. If it is not carried out correctly, the product may tip over or fall, damaging people or things. Because there are walls of different materials, the screws for fixing to the wall are not including. To choose the right fastening accessories, contact a local dealer.

12 Ensure that children do not put any small parts such as nuts, caps or the like in their mouth. They could swallow and choke on them.

13 When assembling the product, please proceed with caution and comply with the assembly instructions.

I Avvisi di sicurezza

Durante il montaggio del mobile, il triangolo segnala i seguenti avvisi. 

1 Il montaggio deve essere effettuato da personale qualificato. Se non viene effettuato correttamente, il prodotto può ribaltarsi o cadere, danneggiando persone o cose. Poiché ci sono pareti di materiali diversi, le viti per il fissaggio alla parete non sono incluse. Per scegliere gli accessori di fissaggio adatti, rivolgeti a un rivenditore locale.

12 Tenere lontano dai bambini pezzi di ferramenta come viti copriviti ecc. per evitare un eventuale soffocamento.

13 Seguire scrupolosamente lo schema di montaggio.

F Avis de sécurité

Ces avis vous seront rappelés durant la montage par ce triangle. 

1 Le montage doit être effectué par du personnel qualifié. Si cela n'est pas effectué correctement, le produit risque de basculer ou tomber, endommager des personnes ou des choses. Parce qu'il y a des murs de différents matériaux, les vis pour la fixation au mur ne sont pas y compris. Pour choisir les accessoires de fixation appropriés, contactez un revendeur local.

12 Tenir éloignés les enfants pour éviter qu'ils ne mettent pas de petites pièces dans leur bouche, ils pourraient les avaler et s'étouffer.

13 Durant le montage de votre meuble veuillez procéder avec prudence et respecter les instructions de montage.

NL Veiligheidsinstructies

De driehoek herinnert u tijdens de installatie van de volgende meldingen. 

1 De montage moet worden uitgevoerd door gekwalificeerd personeel. Als het niet correct wordt uitgevoerd, kan het product kantelen of vallen, mensen of dingen beschadigen. Omdat er muren zijn van verschillende materialen, de schroeven voor bevestiging aan de muur zijn dat niet inclusief. Neem contact op met een lokale dealer om de juiste bevestigingsaccessoires te kiezen.

12 Zorg ervoor dat kinderen geen kleine stukken, zoals moeren, afdekkapjes of dergelijke in de mond nemen. Ze kunnen ze inslikken en daardoor stikken.

13 Ga bij de montage van het artikel zorgvuldig te werk en houd u aan de handleiding voor de montage.

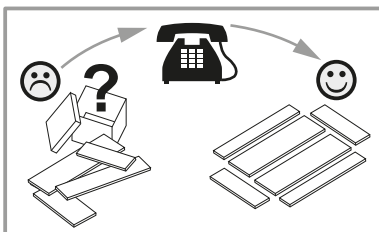
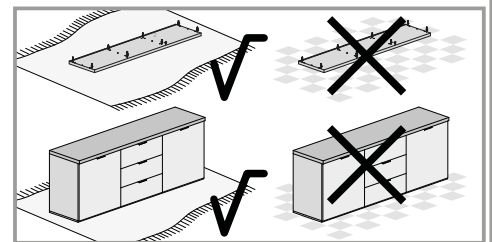
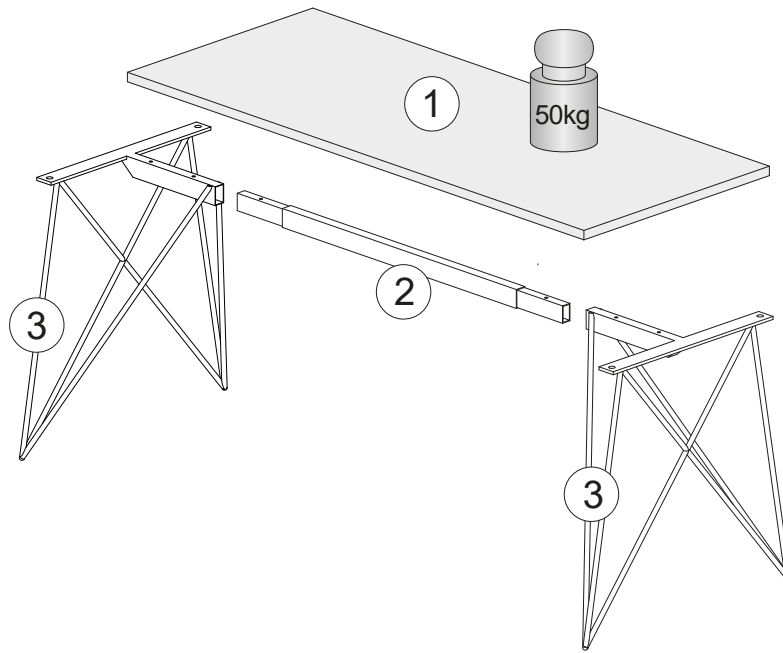

Cod.	Qt.	Dimensions (mm)	Item Code	Box
1	1	1600x650x25	XP_COBREPK1-ANT	12/3 - 2/2
2	1	1140x50x30	XP_FETS07-NER	2/3 - 2/2
3	2	730x360x730	XP_FETS06-NER	1/2

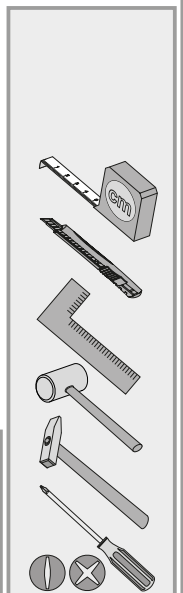
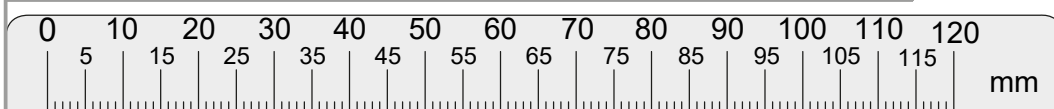

1

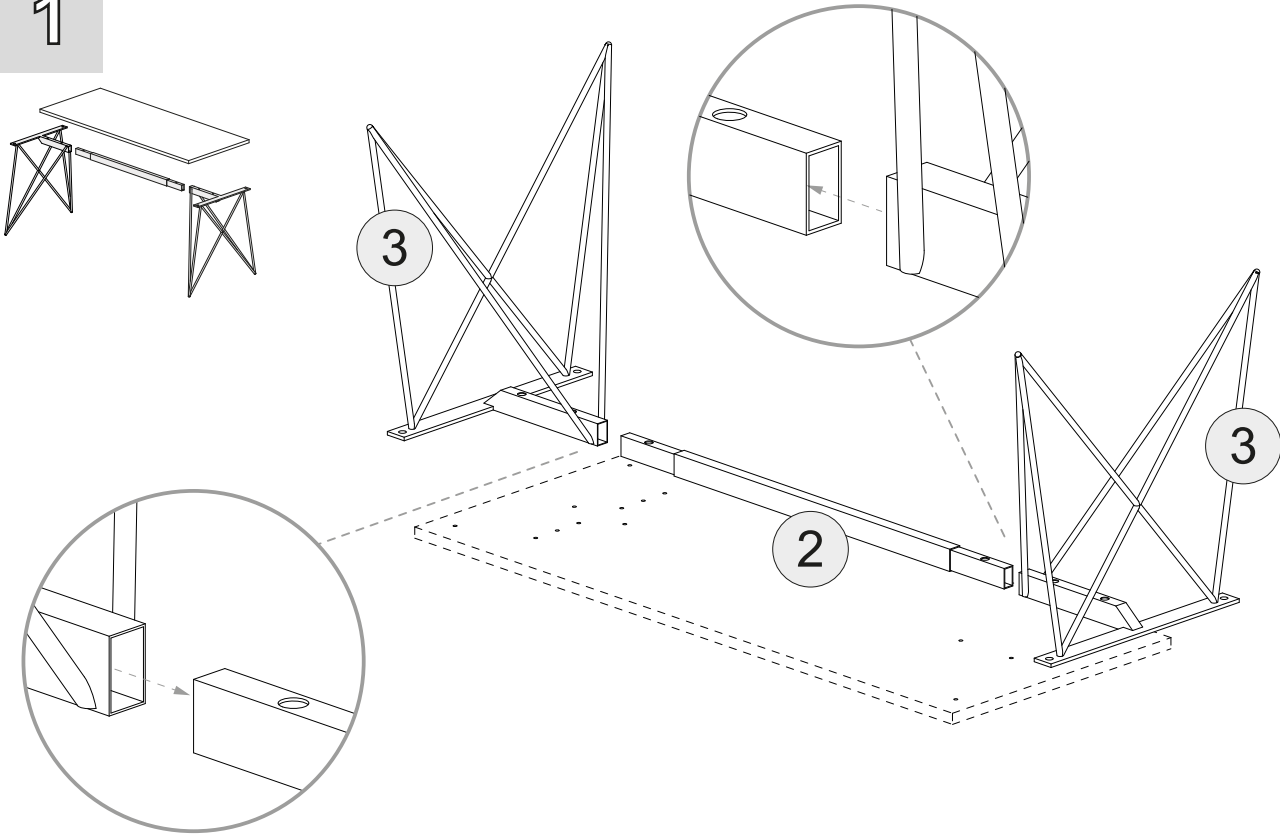

2

