

**Nr 1**

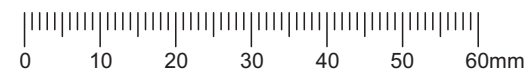

001655	8x40		x3
6x50			x3
000181			x3
000089	Ø7x70		x6
000093			x1
001489	M4x20		x3
005776	M5x35		x2
000692	M5x20		x2
005771			x1
005772			x3

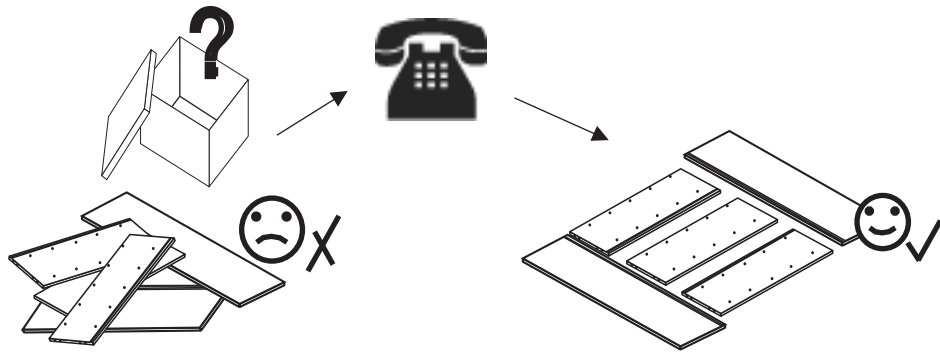

--	--	--	--	--	--	--	--





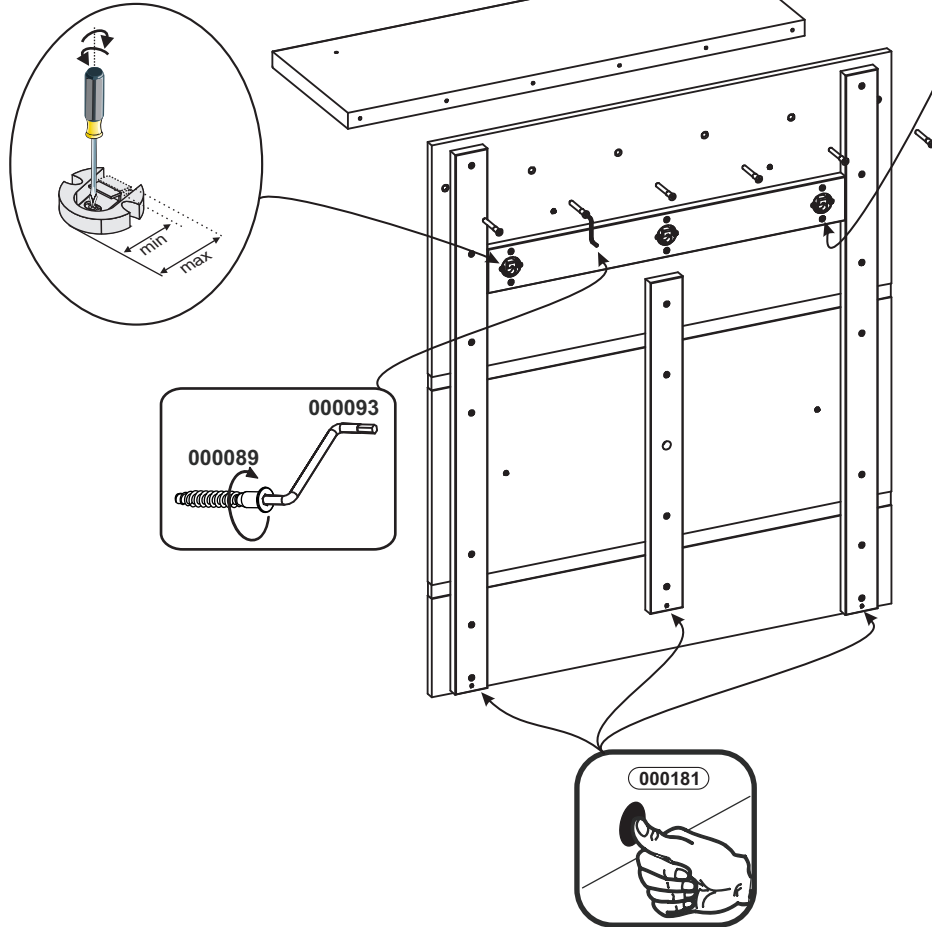
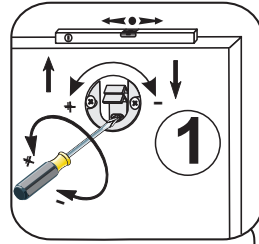

## 1

- 000181  x3
- 000089   $\varnothing 7 \times 70$  x6
- 000093  x1



## 2

- 001489  M4x20 x3
- 005776  M5x35 x2
- 000692  M5x20 x2
- 005771  x1
- 005772  x3

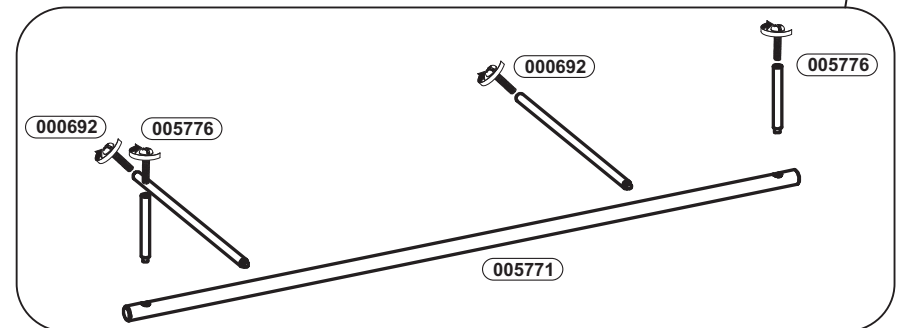
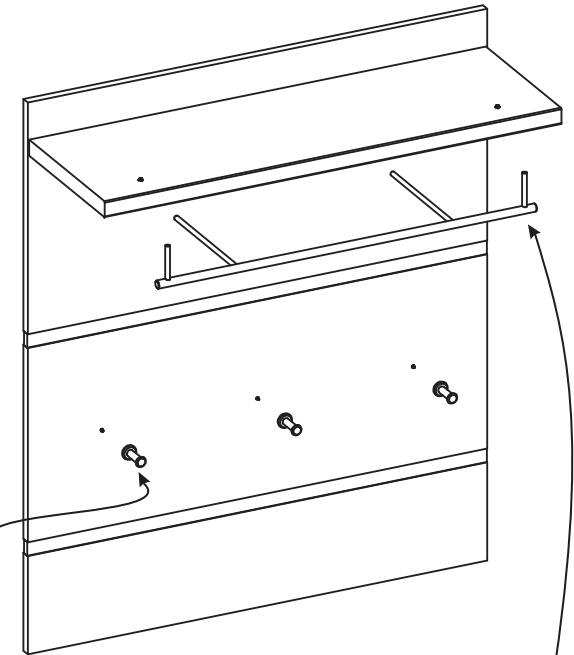
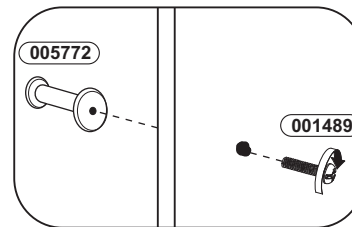

## 3

