

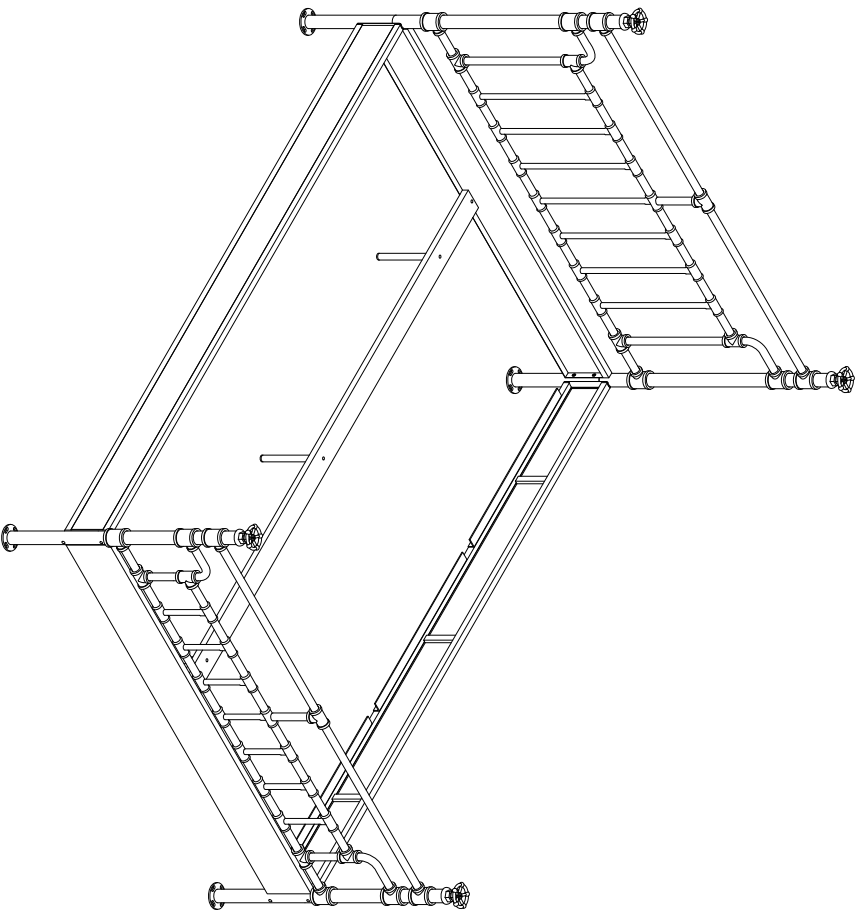

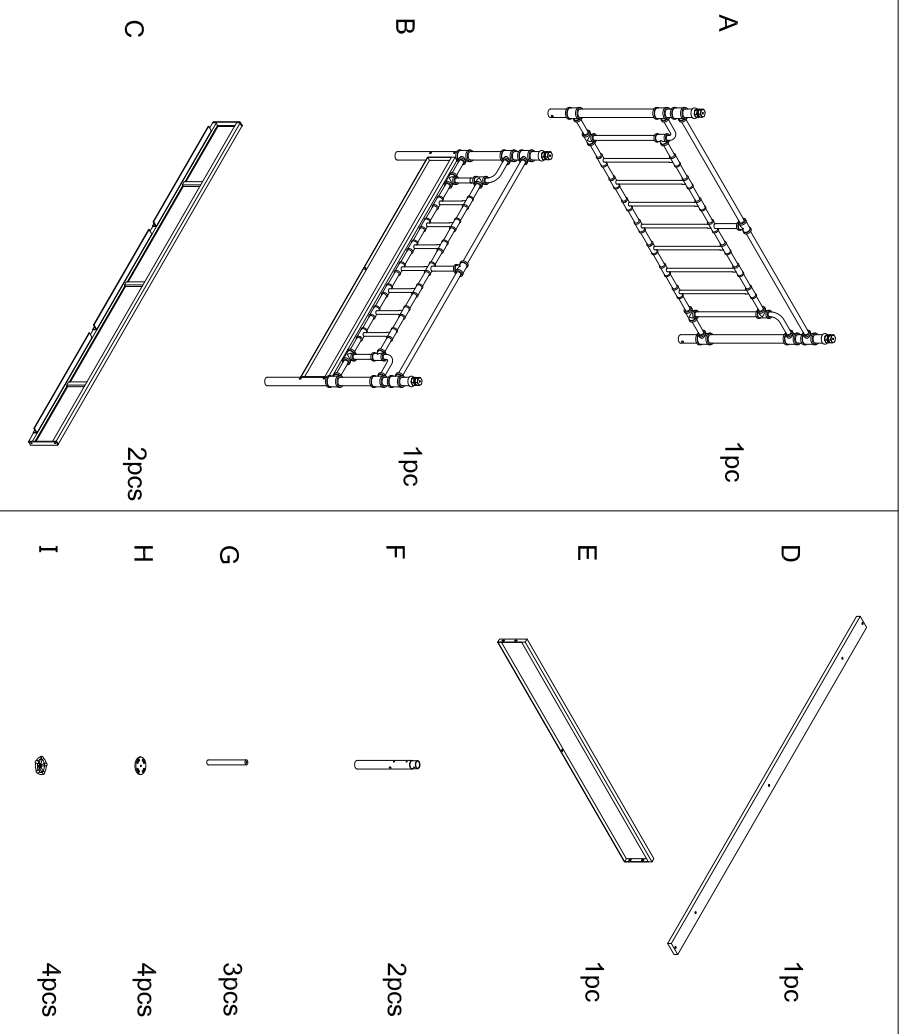





ASSEMBLY INSTRUCTIONS
ITEM NO.:HCB1045



PARTS IDENTIFICATION



HARDWARE LIST

1		6pcs	2		4pcs	3		3pcs
4		8pcs	5		2pcs	6		4pcs
7		4pcs	8		2pcs			

STEP 1.

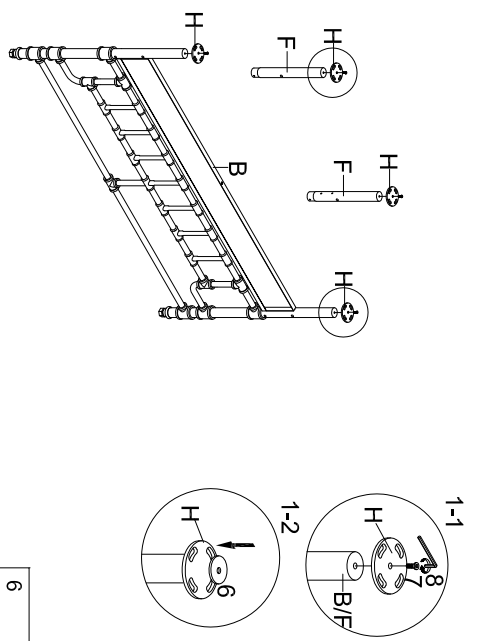

6		4pcs
Ø40		
7		4pcs
M6x25		

STEP 3.

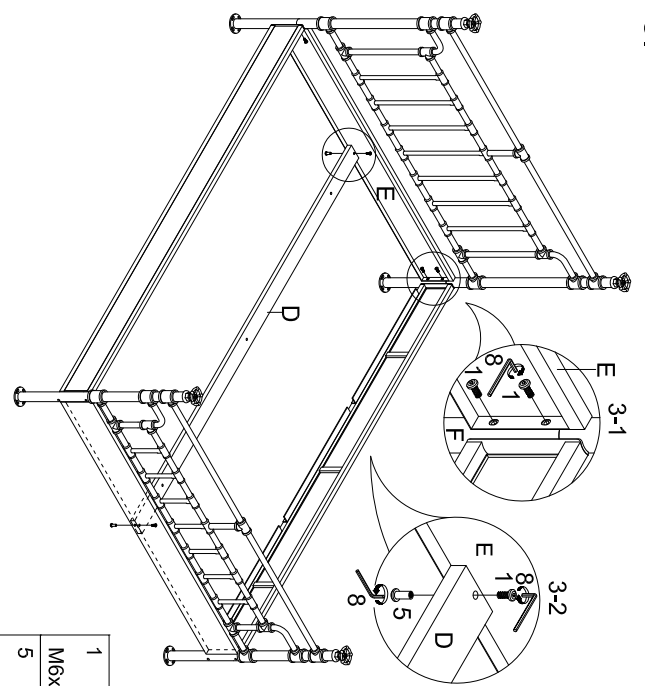

1		6pcs
M6x15		
5		2pcs
M6x10		

STEP 2.

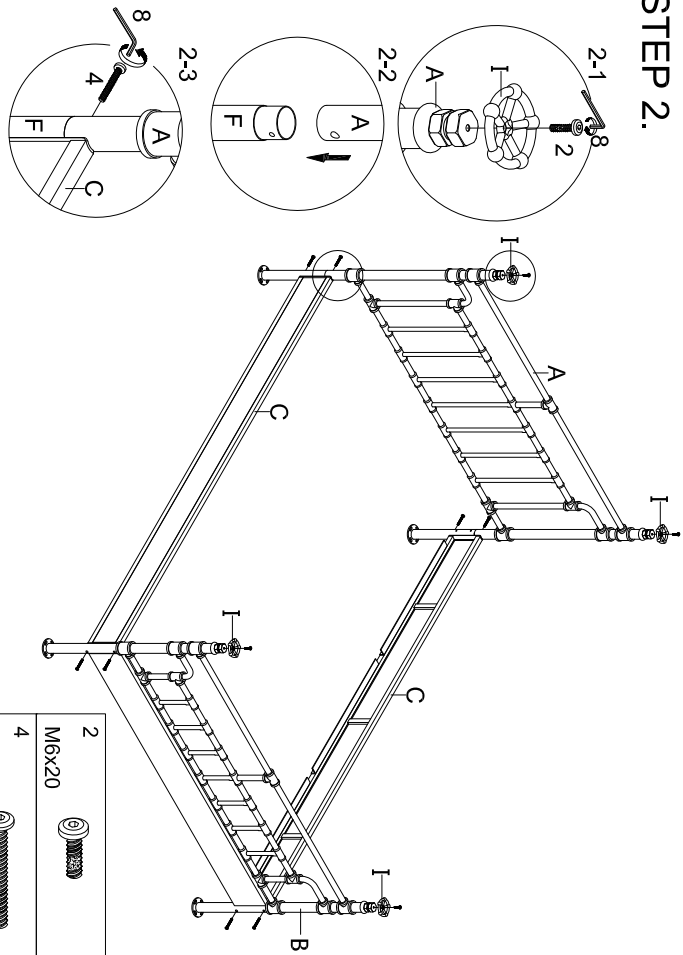

2		4pcs
M6x20		
4		8pcs
M6x50		

STEP 4.

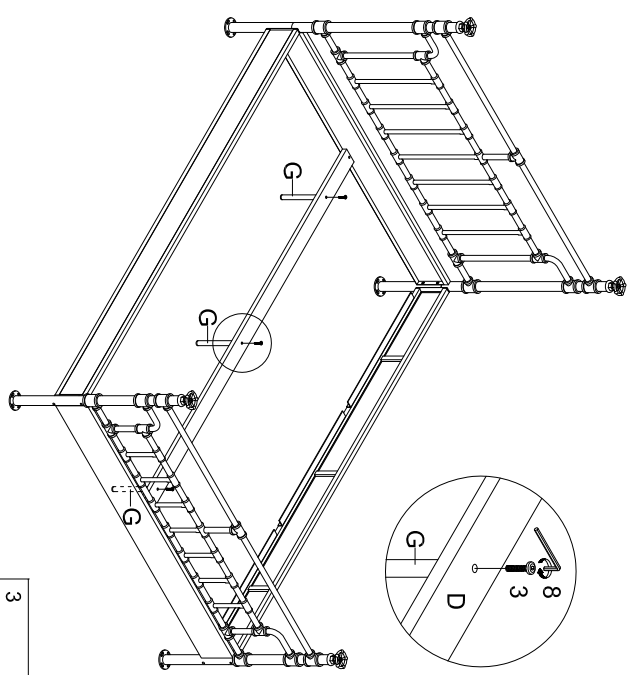

3		3pcs
M6x35		