

CAMRON - KOMMODE TYP 1T4L

00030001-33

60 MIN

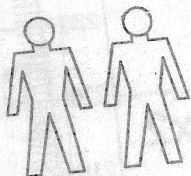

1079 mm

895 mm

430 mm

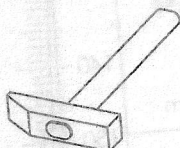
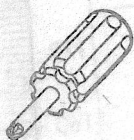
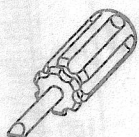
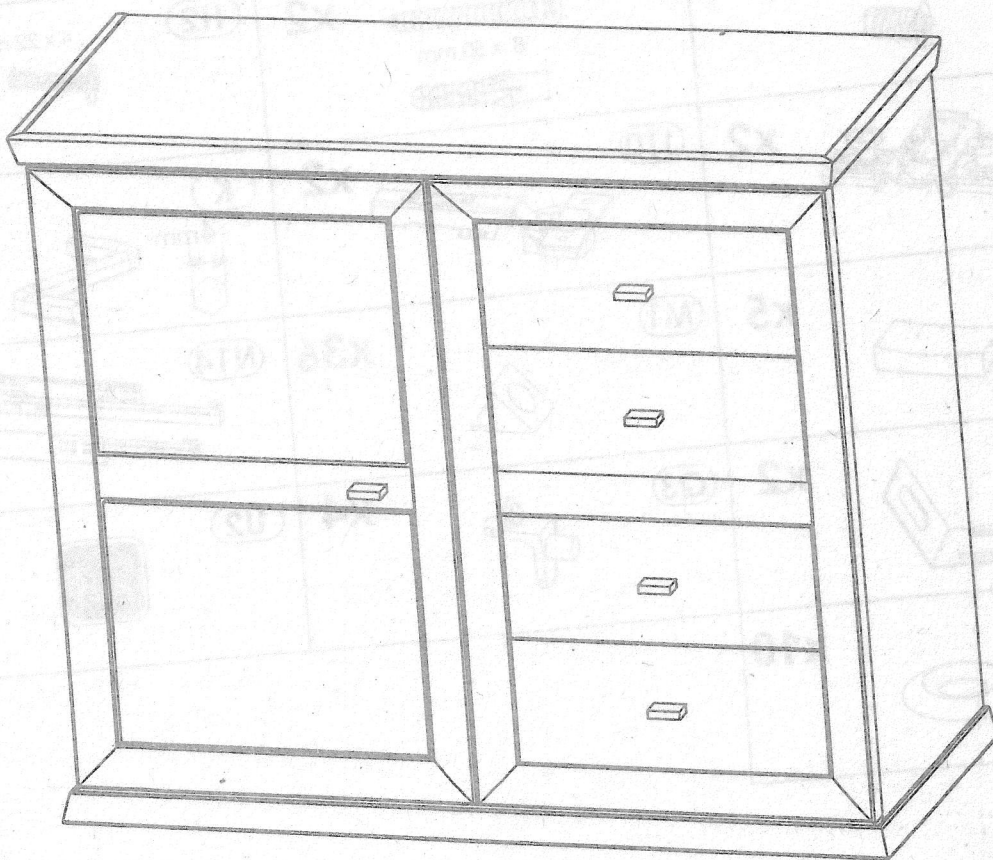



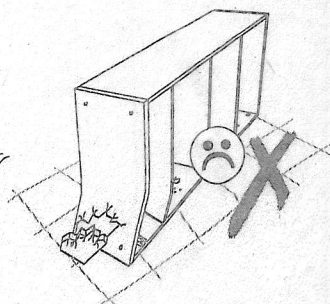
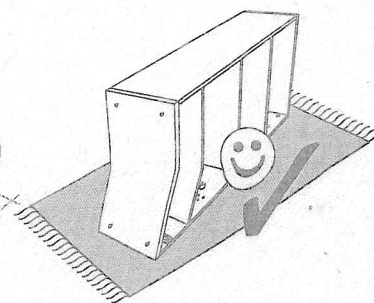
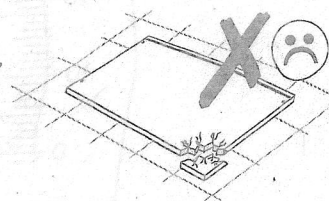
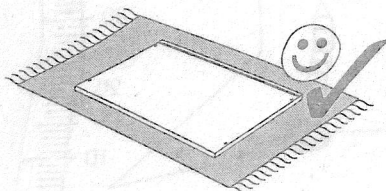



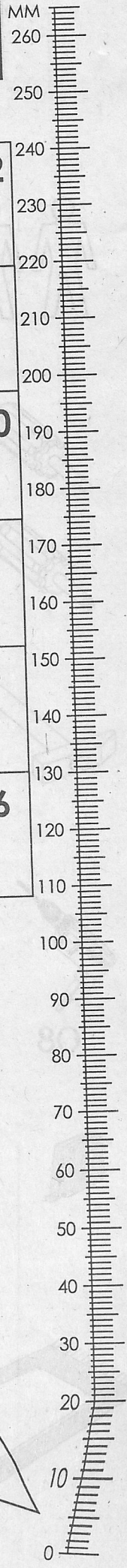



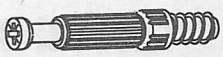

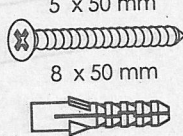

08

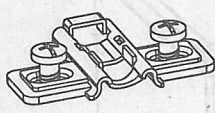
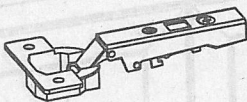
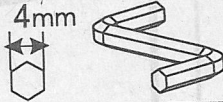
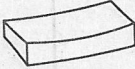

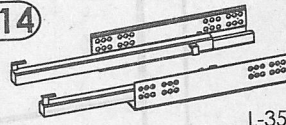
CAMRON - KOMMODE TYP 1T4L



(B1)  f 7 x 50 mm x8	(C0)  x26	(C2)  x32
(D0)  3 x 15 mm 36	(D10)  4 x 16 mm x4	(D21)  5 x 13 mm x2
(D31)  6,3 x 13 mm x32	(E0)  5 x 50 mm x2 8 x 50 mm	(H2)  4 x 22 mm x10
(J3)  x2	(J10)  x2	(K)  4mm x1
(L6)  x5	(M1)  x36	(N14)  L-350mm x4
(P0)  x2	(Q3)  x4	(U2)  x6
(U3)  x10		

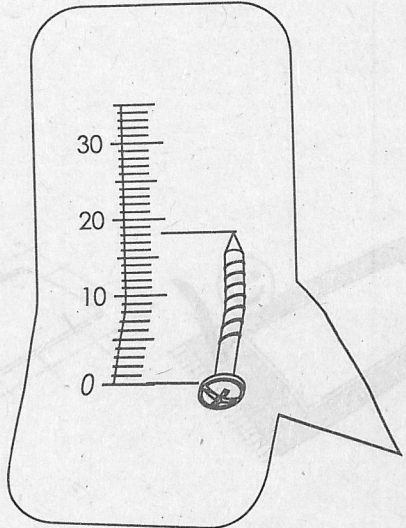

CAMRON - KOMMODE TYP 1T4L

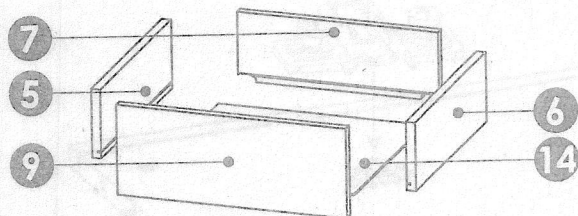
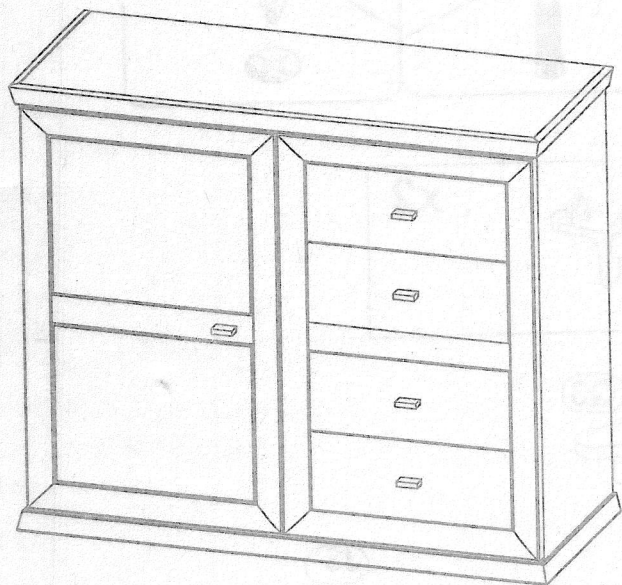

x4

1	837	393	16 x1	1/3
2	837	393	16 x1	1/3
3	837	393	16 x1	1/3
4	837	373	16 x1	1/3
5	350	120	16 x4	1/3
6	350	120	16 x4	1/3
7	372	117	16 x4	1/3
8	547	373	16 x1	1/3
9	406	157	16 x4	2/3
10	805	521	25 x1	2/3
11	805	520	25 x1	2/3
12	1079	430	40 x1	3/3
13	1079	430	40 x1	3/3
14	382	344	2.8 x4	1/3
15	847	557	2.8 x1	2/3
16	847	462	2.8 x1	2/3
				1/3

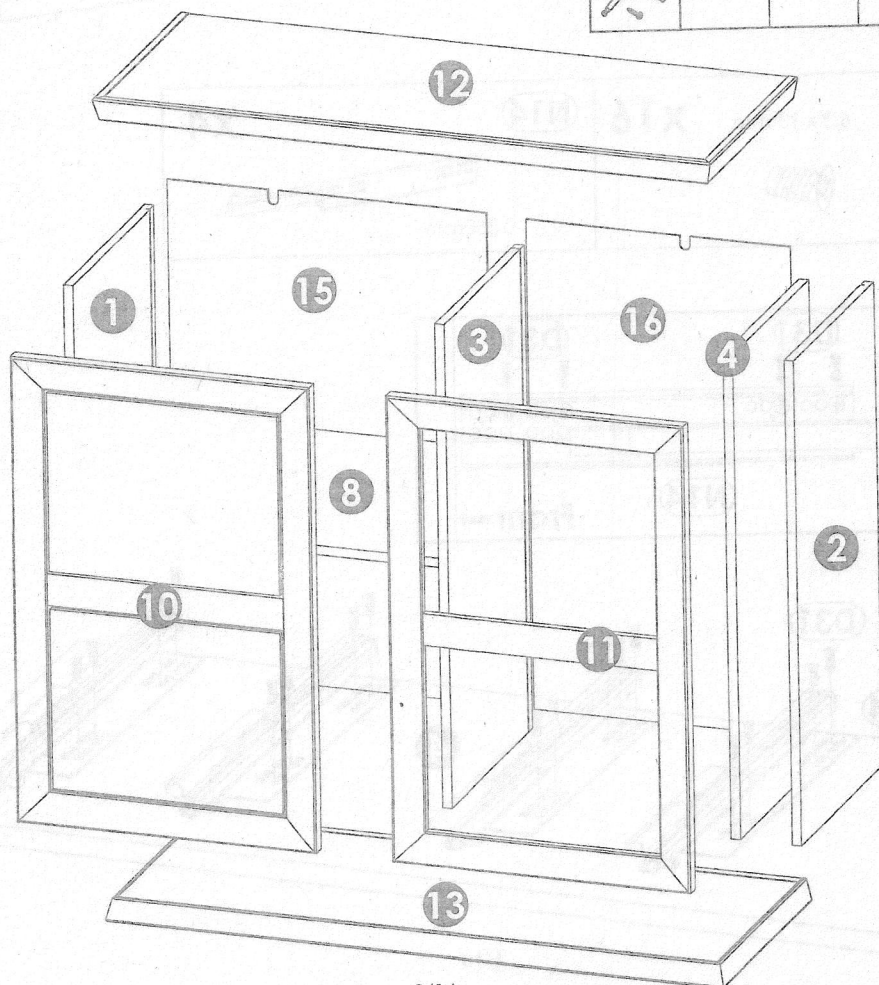

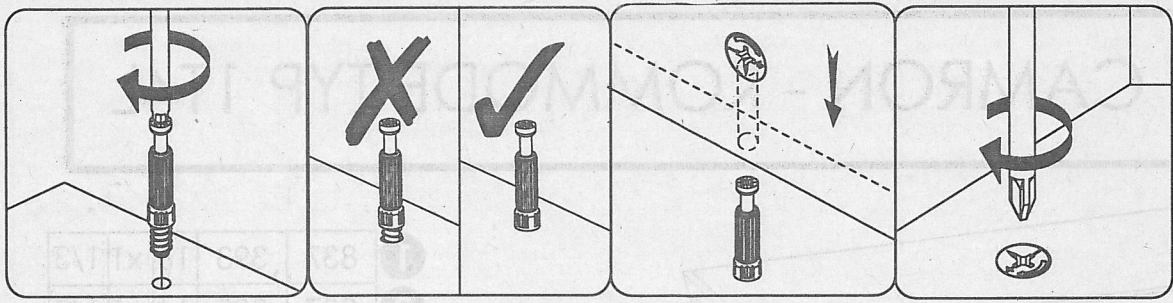

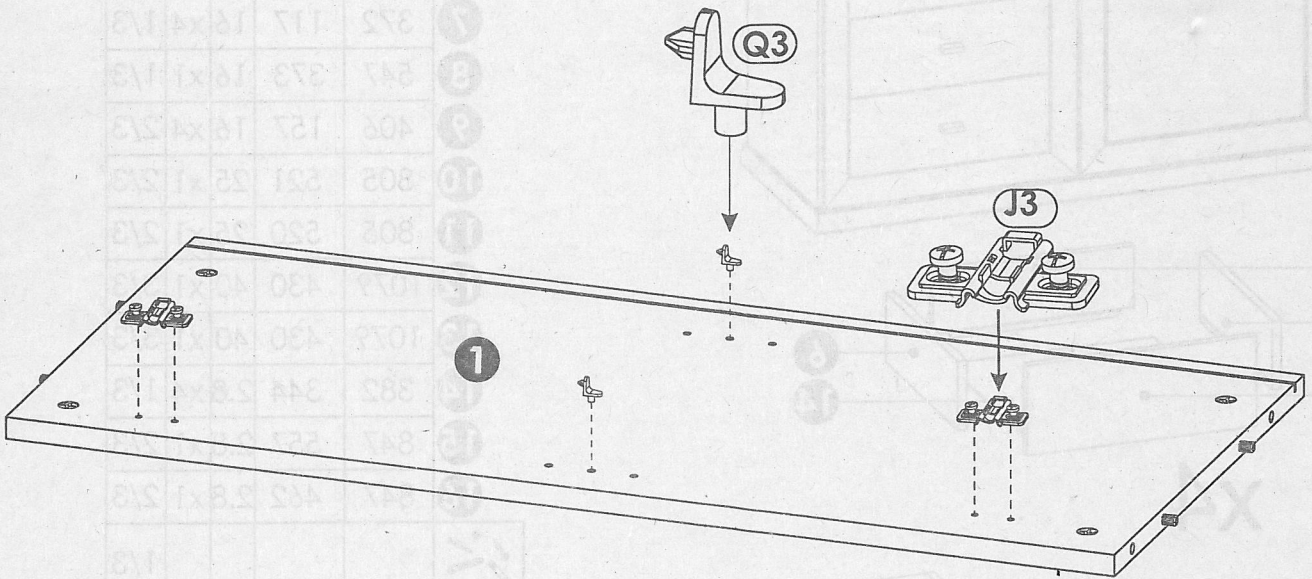
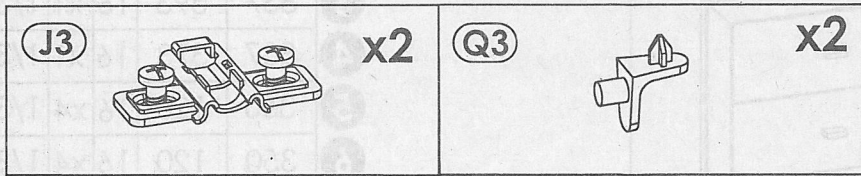

1 ▶

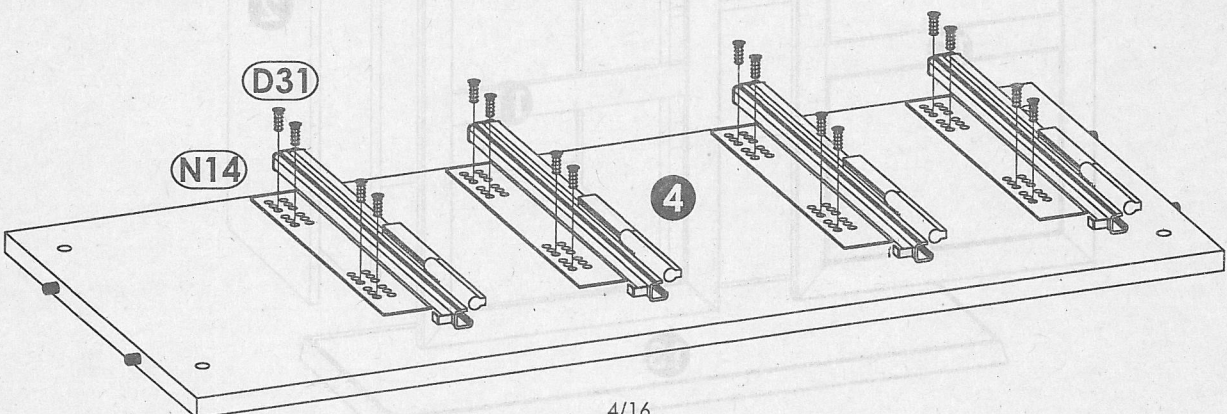
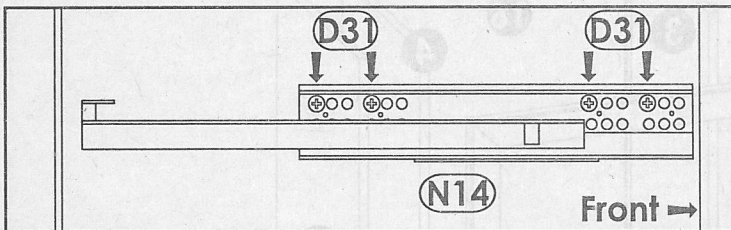
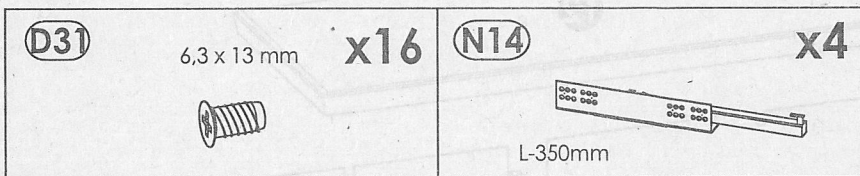

2 ▶



3 ▶

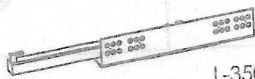
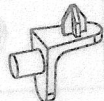

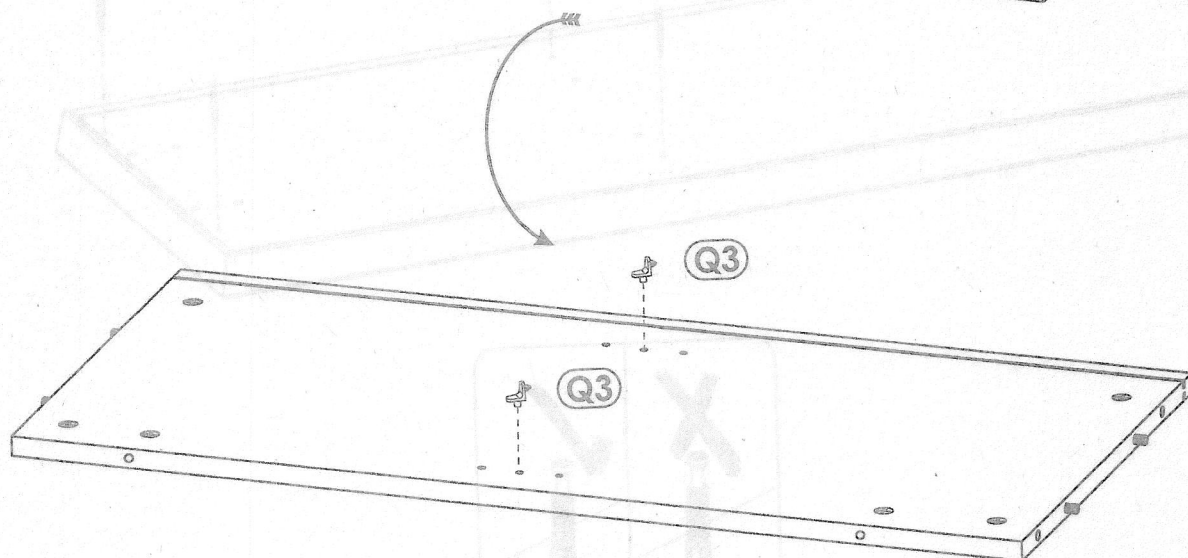
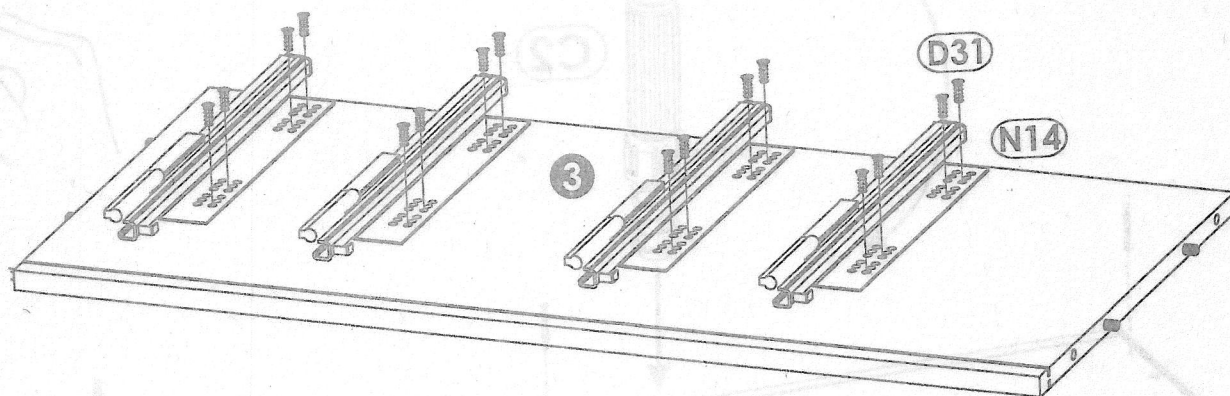
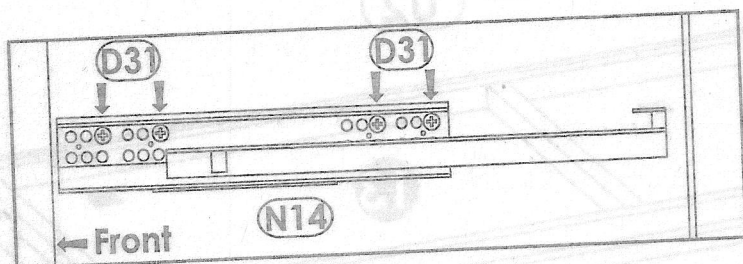
(D31) 6,3 x 13 mm x16 	(N14) x4  L-350mm	(Q3) x2 
---	--	--

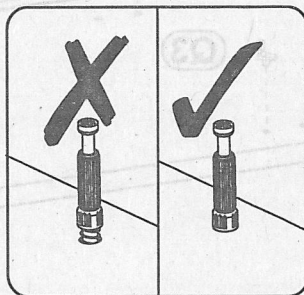
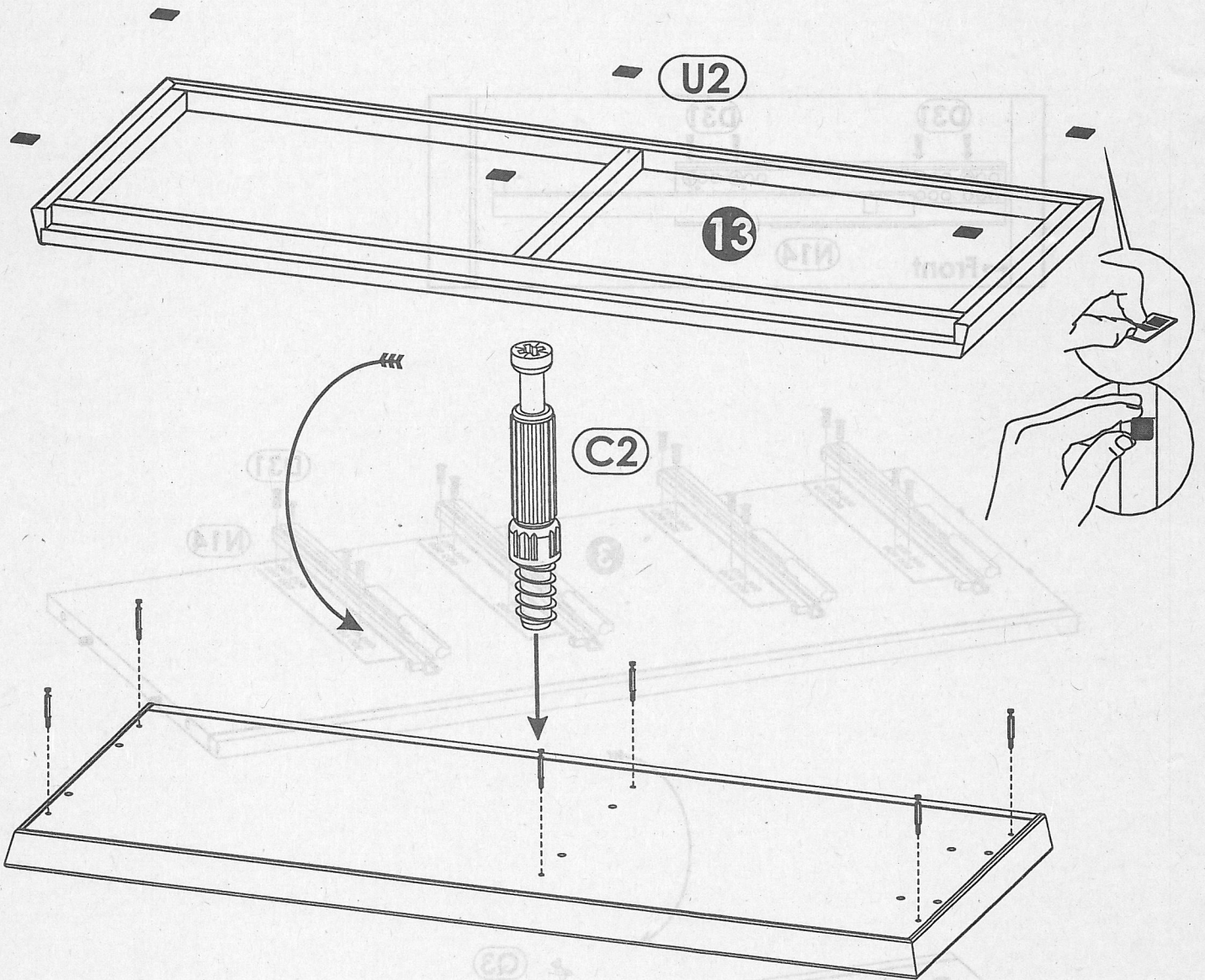
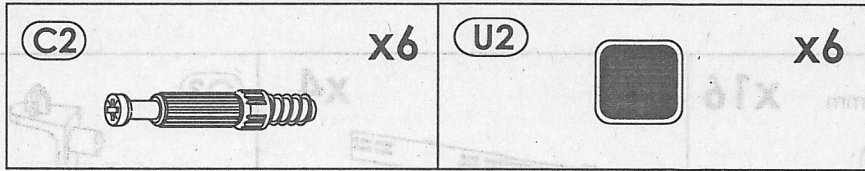

4 ▶



5 ▶

 C2	x6	 D21	5 x 13 mm	x2	 P0	x2
---	-----------	--	-----------	-----------	---	-----------

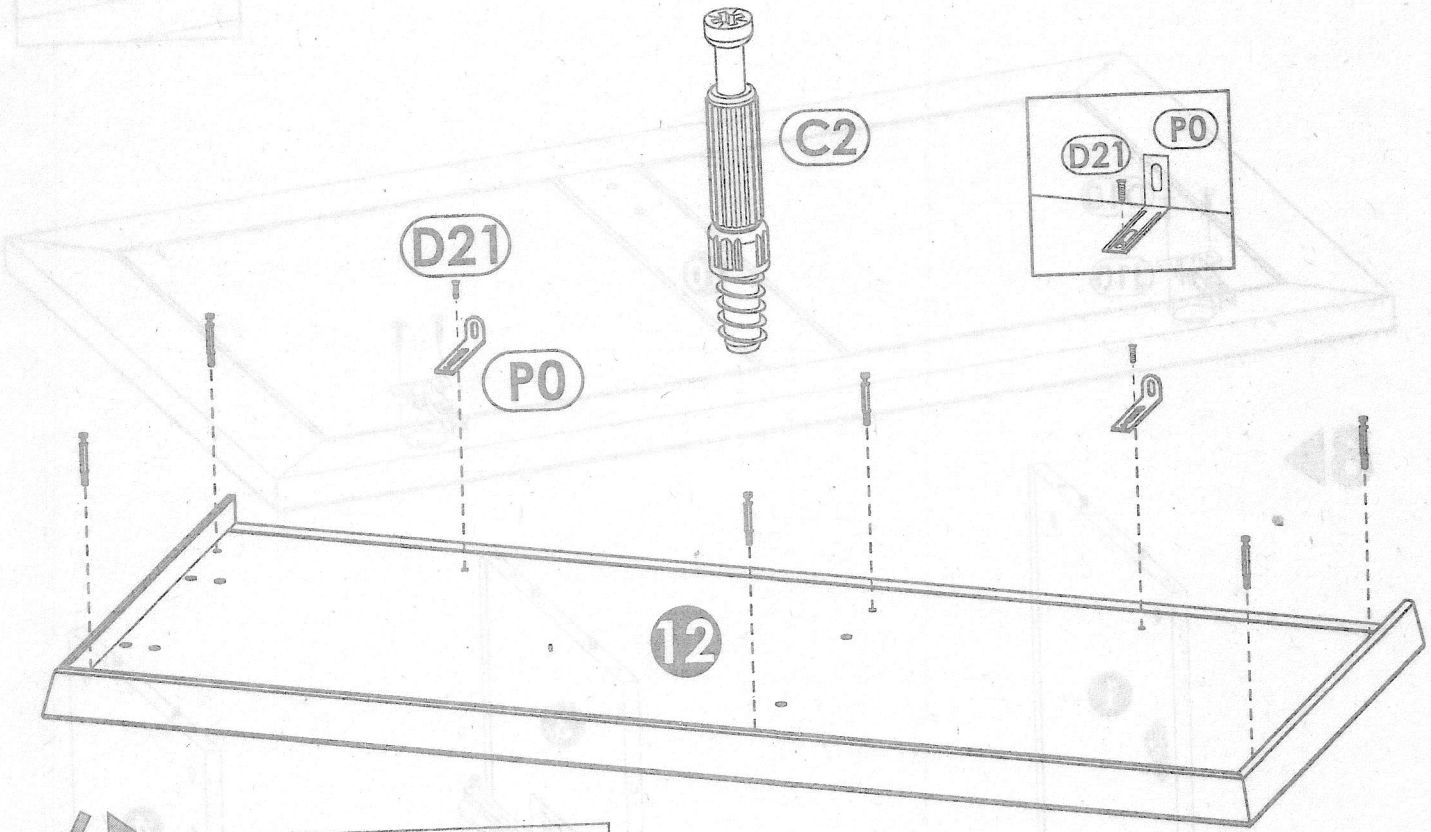

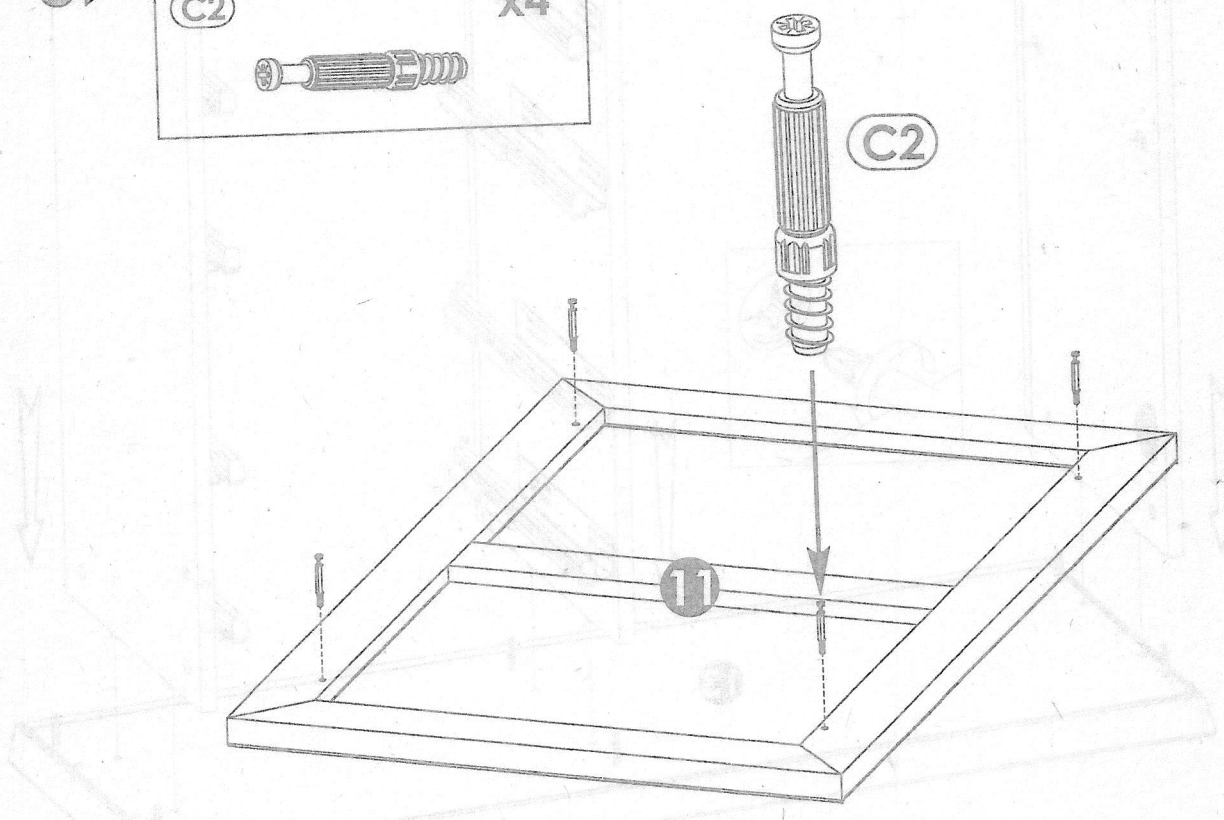

6 ▶

 C2	x4
---	-----------

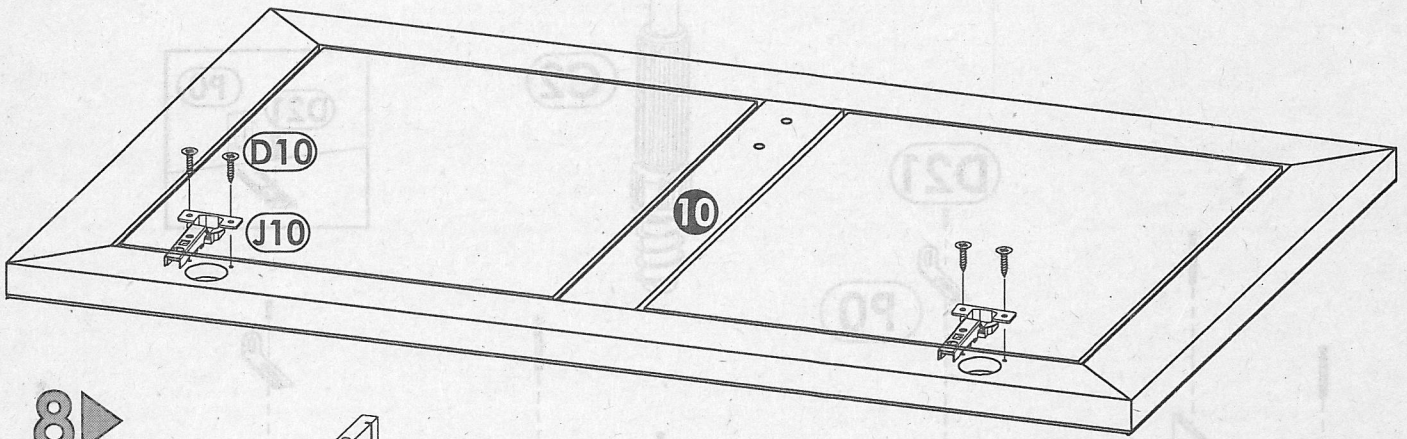
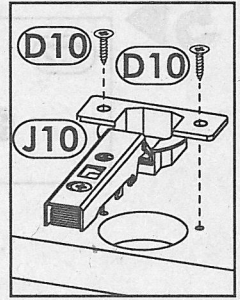

7 ▶

D10	4 x 16 mm	x4	J10	x2
------------	-----------	-----------	------------	-----------



8 ▶

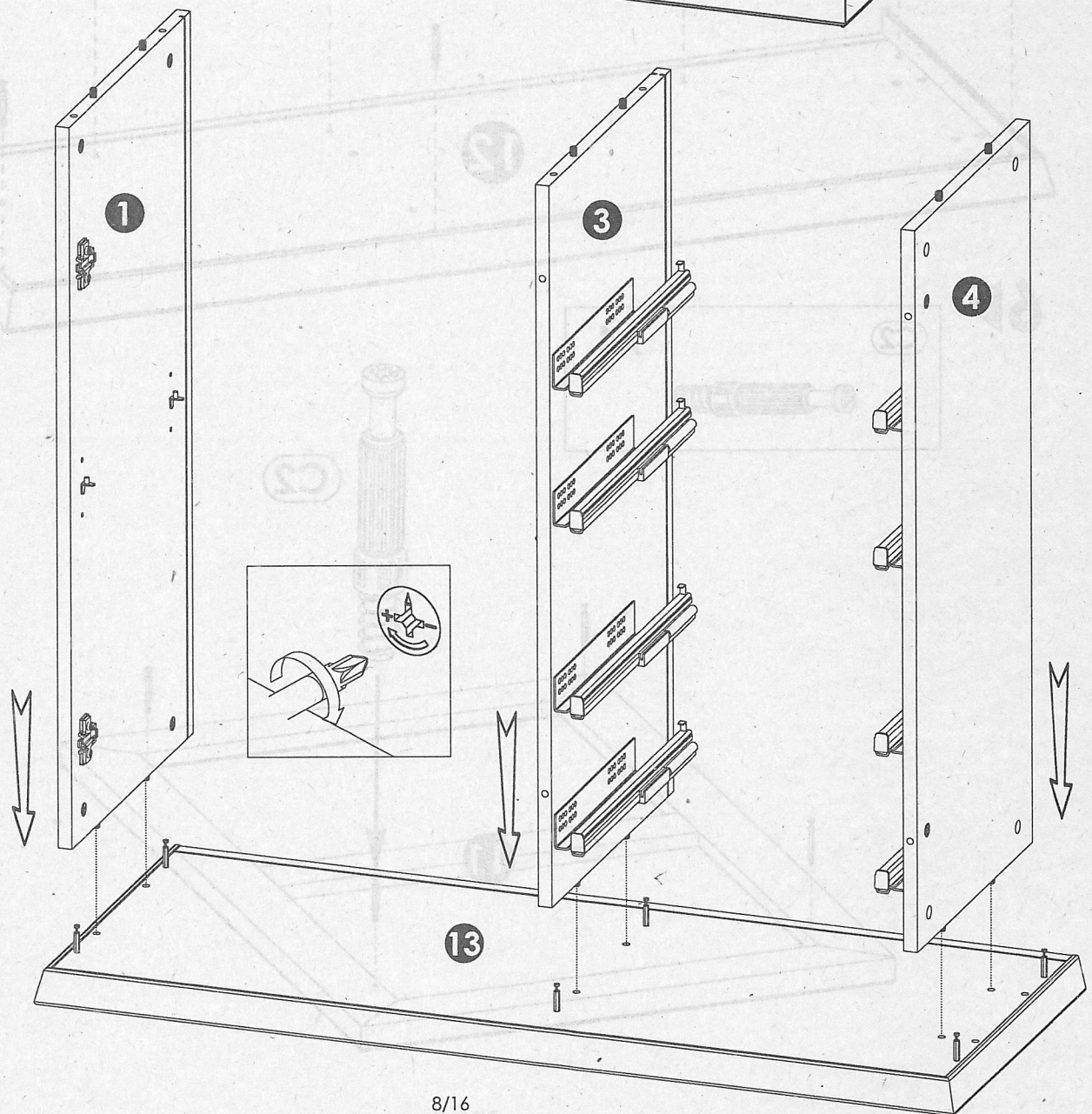

9 ▶

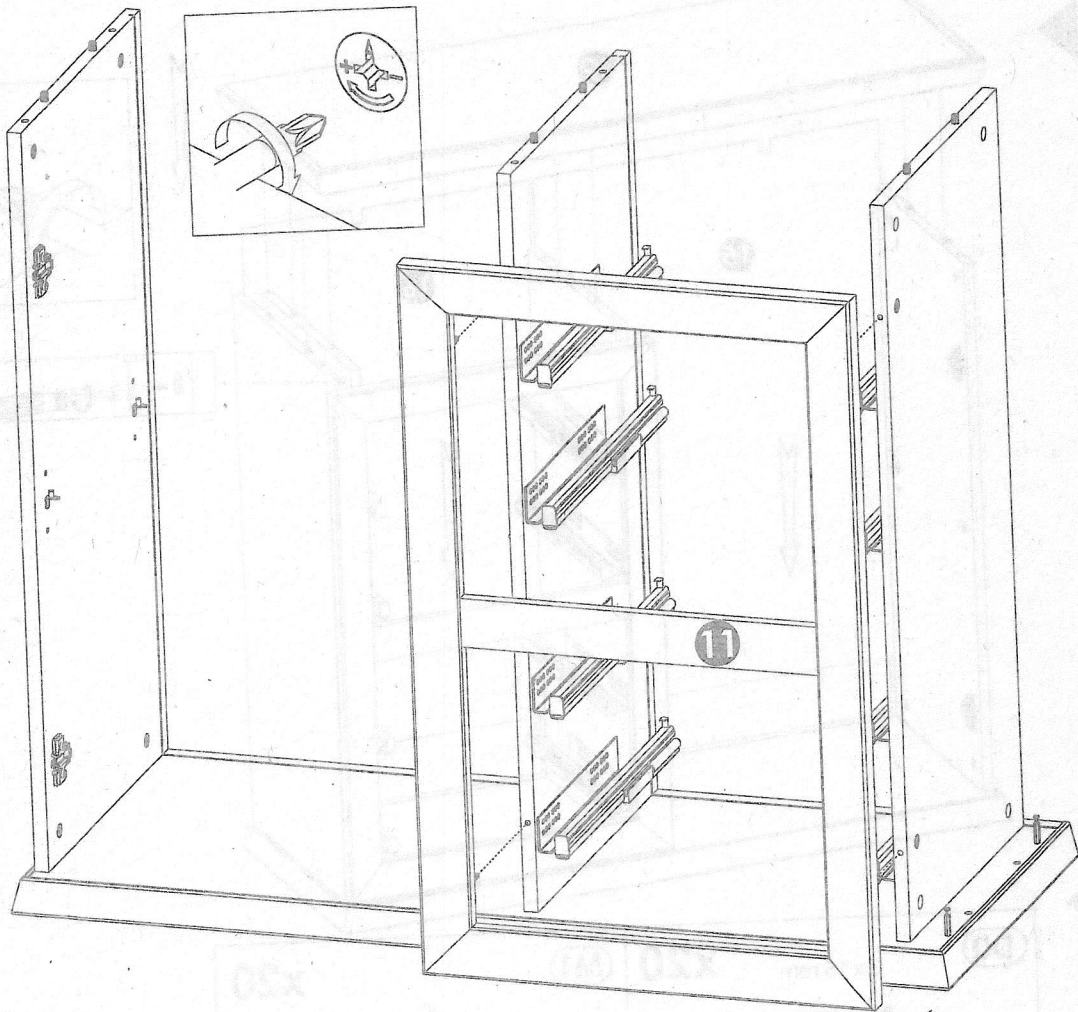

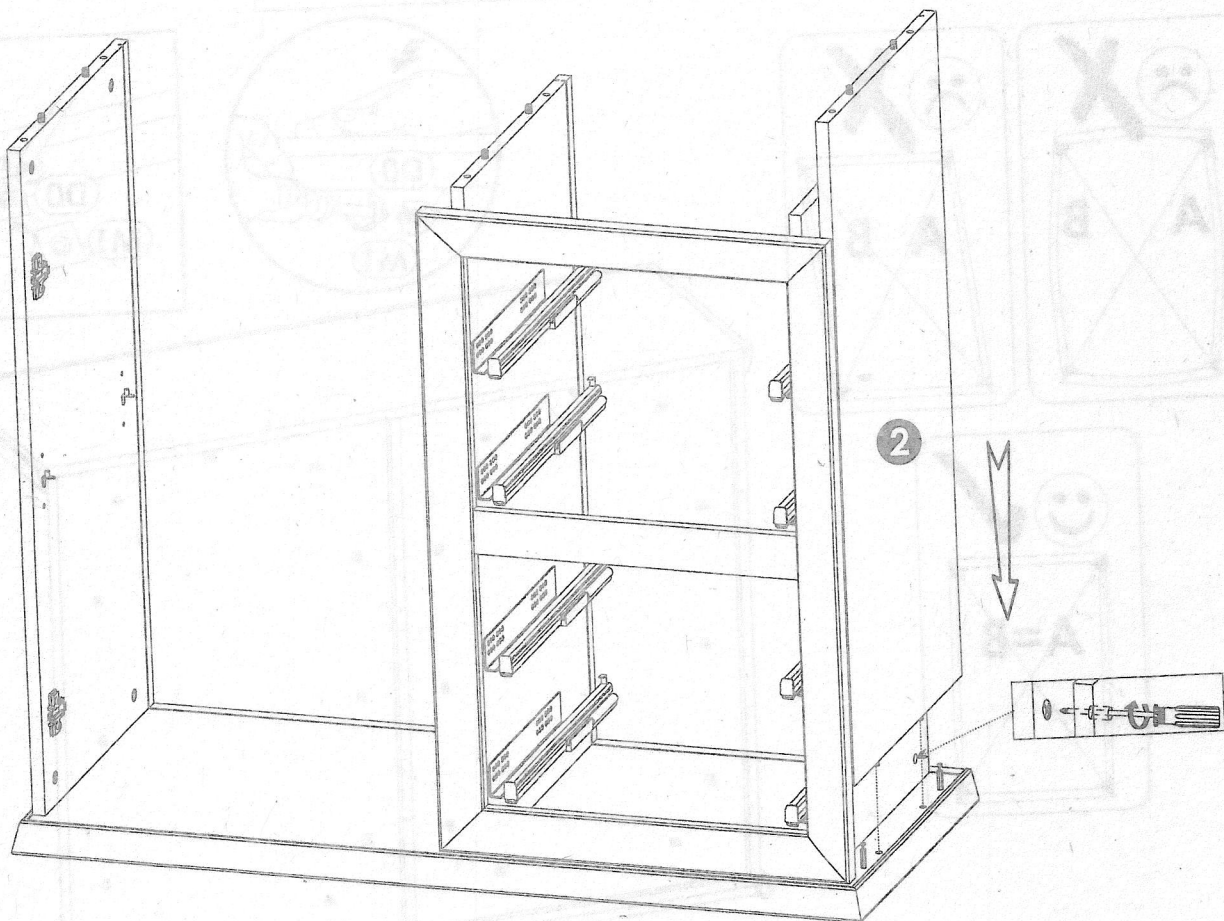

10 ▶

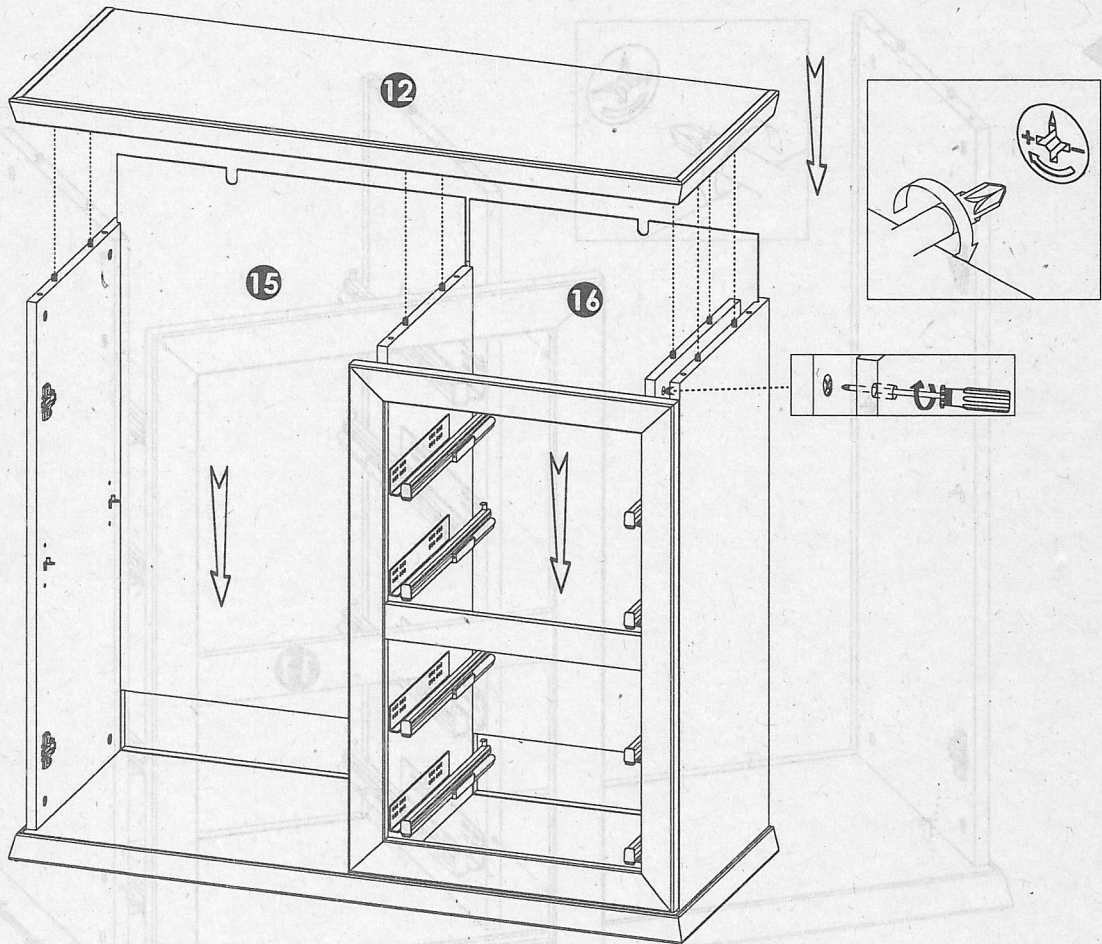

11▶



12▶

(D0)	3 x 15 mm	x20	(M1)		x20
					

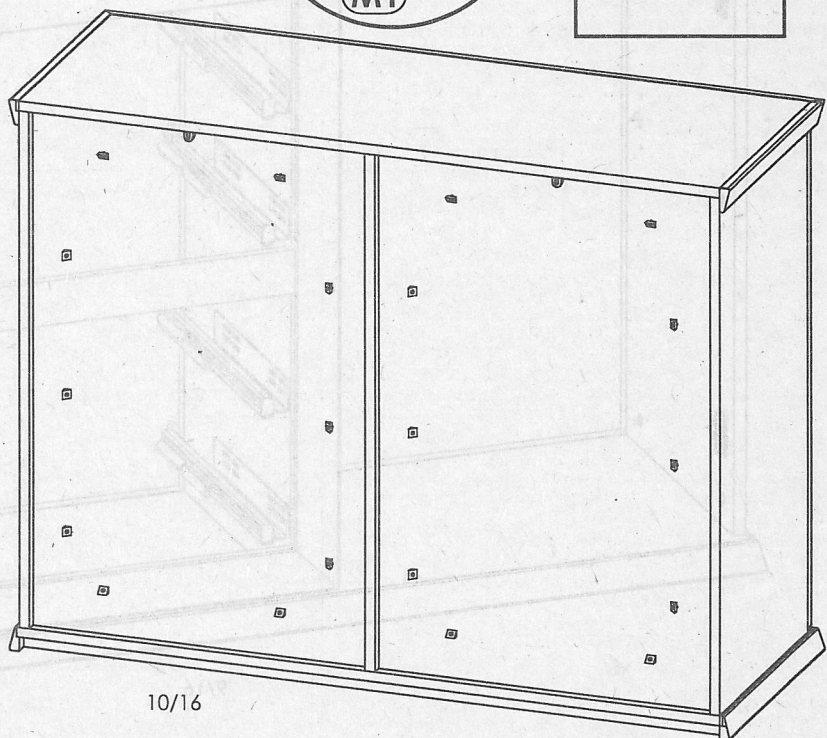
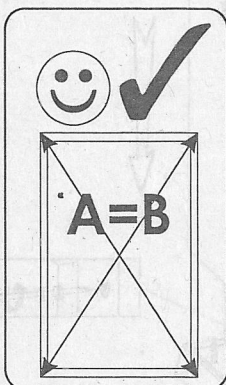
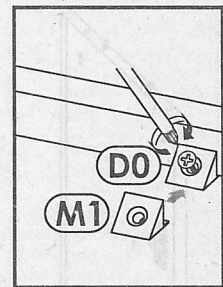
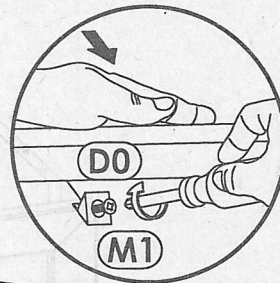
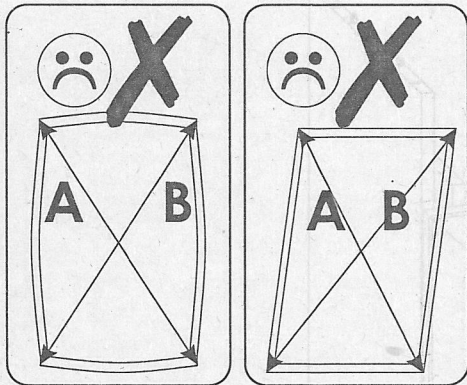

13 ▶

(E0) 5 x 50 mm **x2**
8 x 50 mm

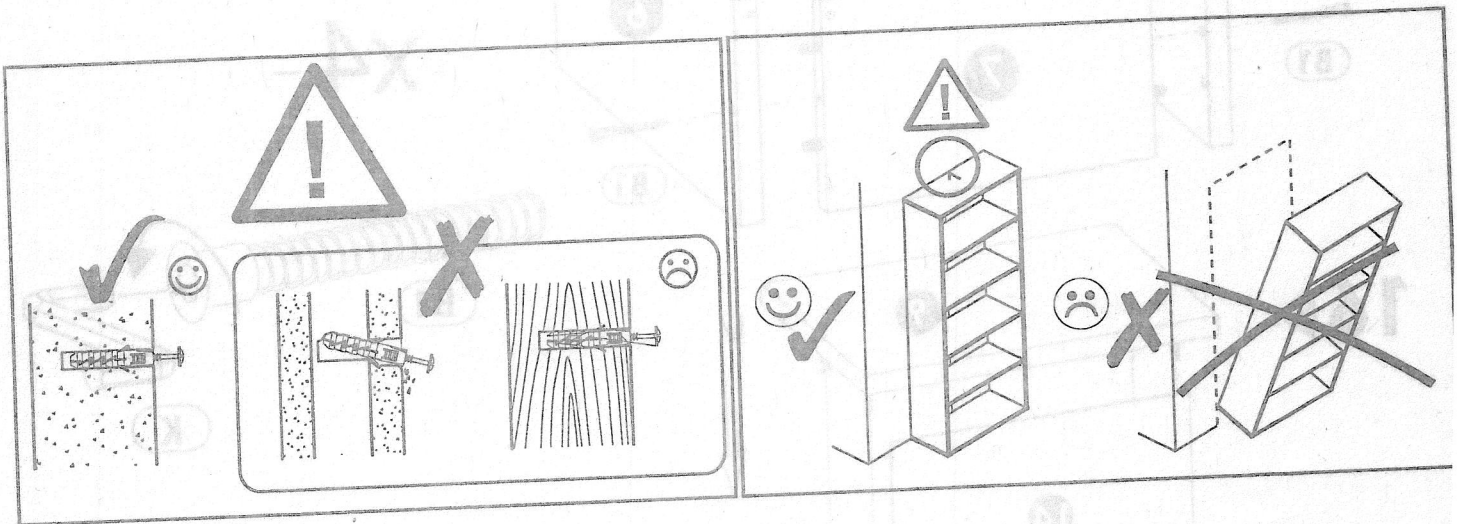
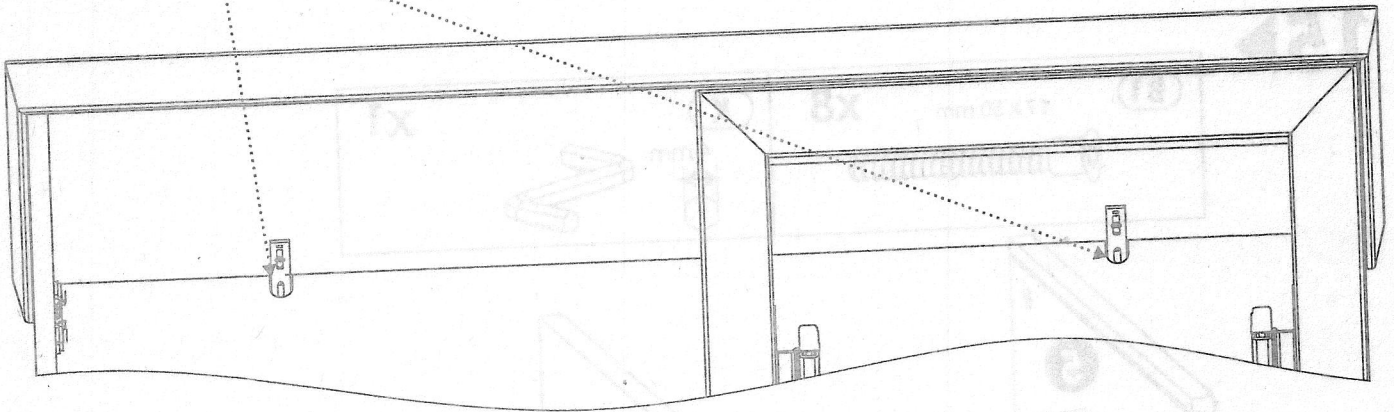
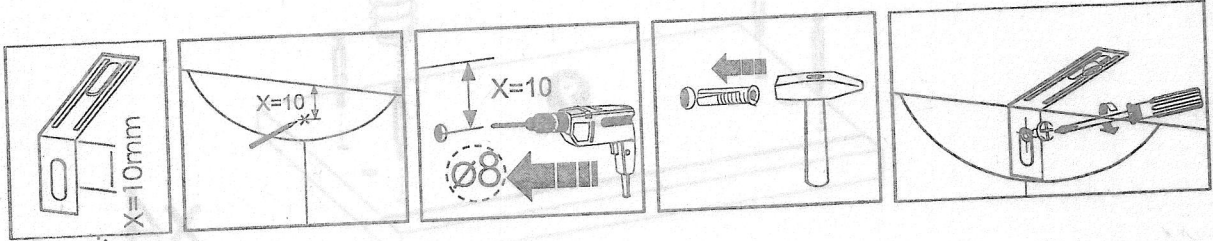

14 ▶

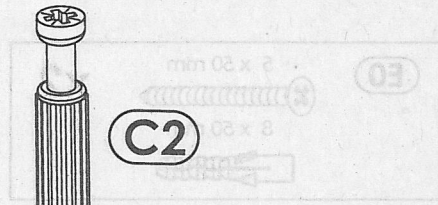
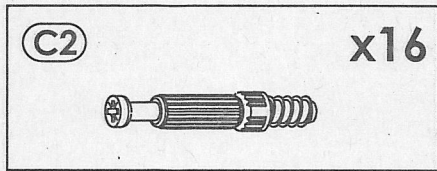

◀ 13

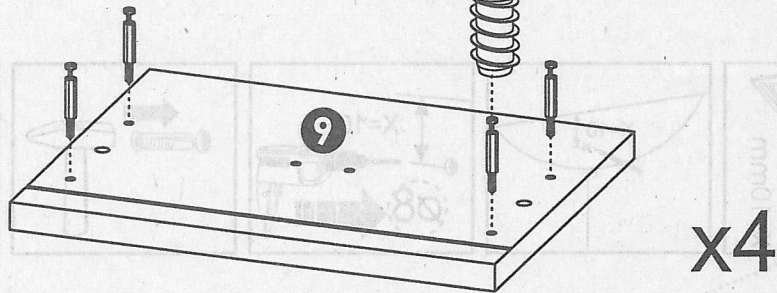

15 ▶

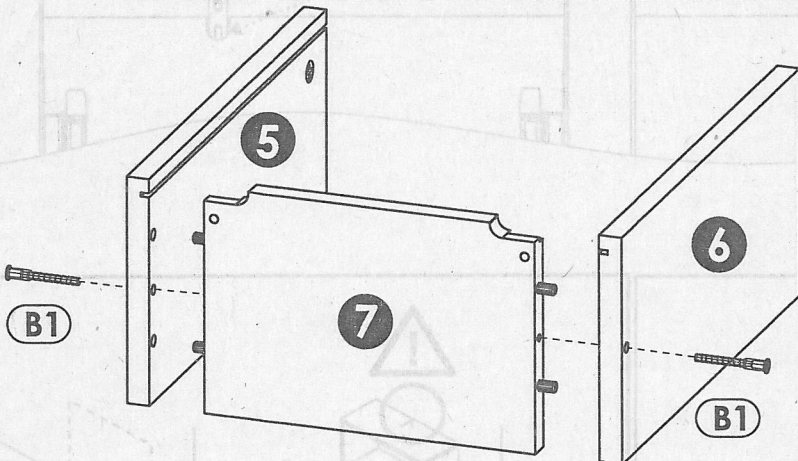
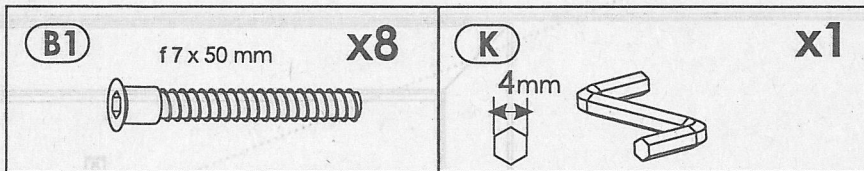

x4

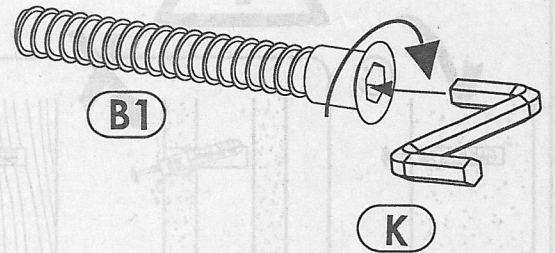

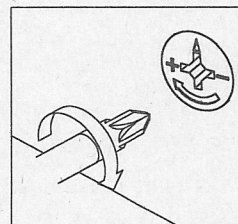
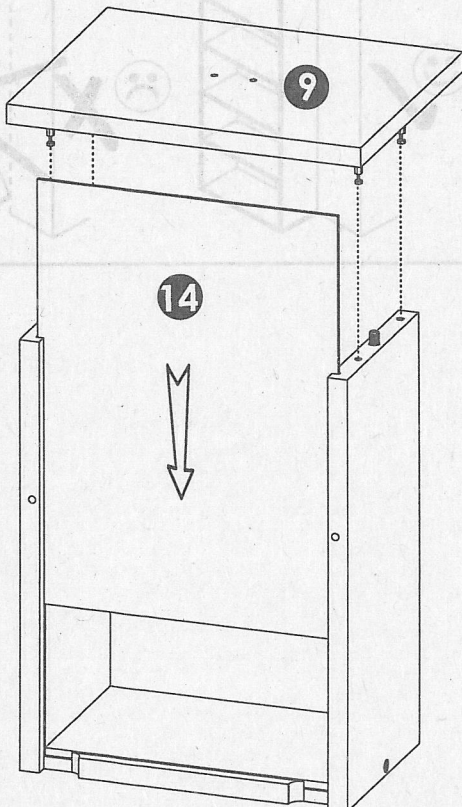

16 ▶



17 ▶

(D0)	3 x 15 mm	x16	(M1)		x16
-------------	-----------	------------	-------------	--	------------

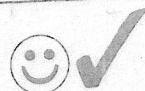

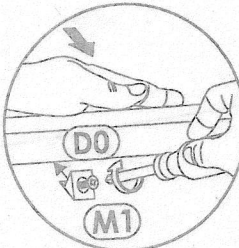
 A=B	 A B	 A B	
---	---	---	--

x4

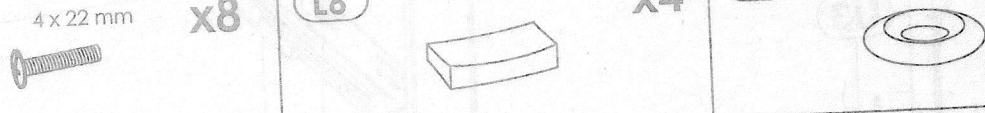

18 ▶

(H2)	4 x 22 mm	x8	(L6)		x4	(U3)		x8
-------------	-----------	-----------	-------------	--	-----------	-------------	--	-----------

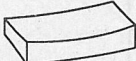

x4

19 ▶

H2	4 x 22 mm	x2	L6		x1	U3		x2
								

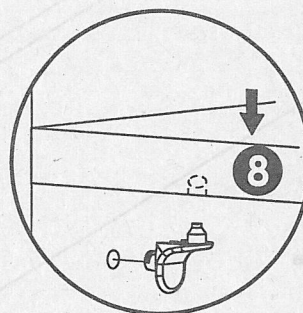
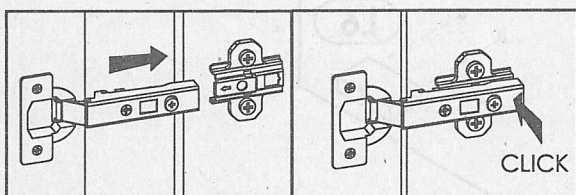
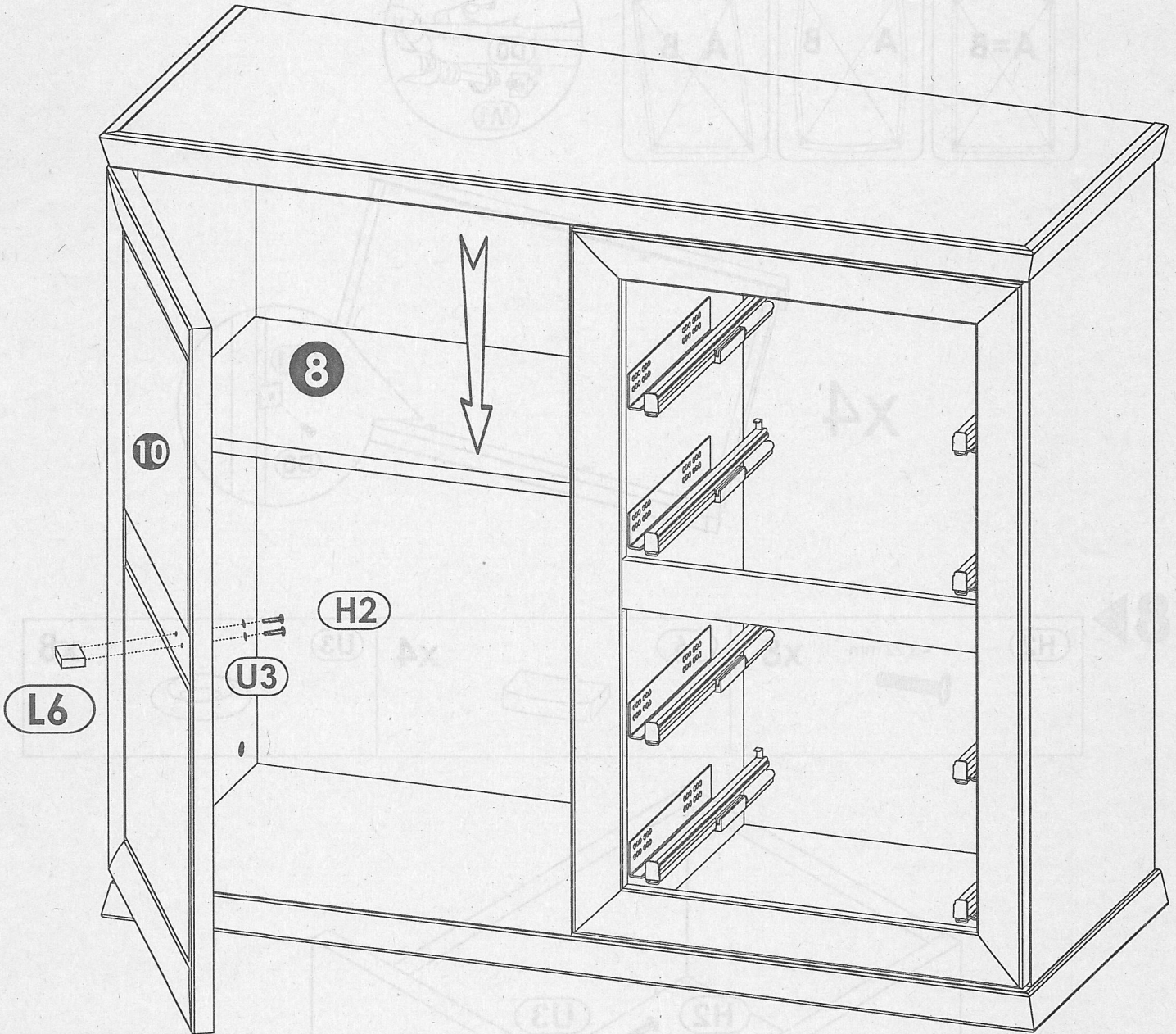

20 ▶

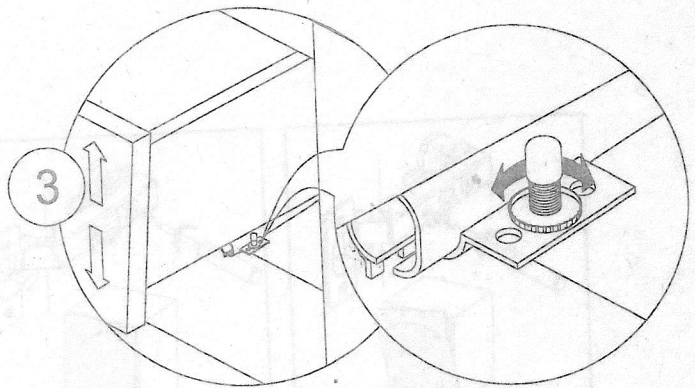
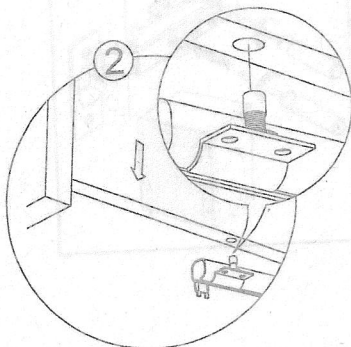
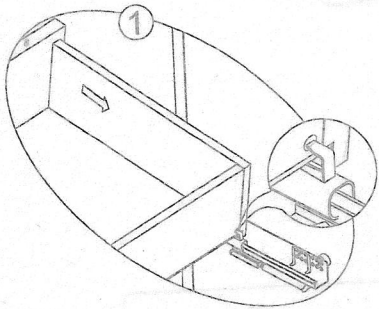
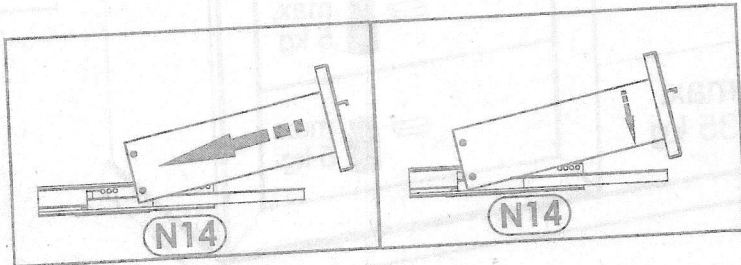
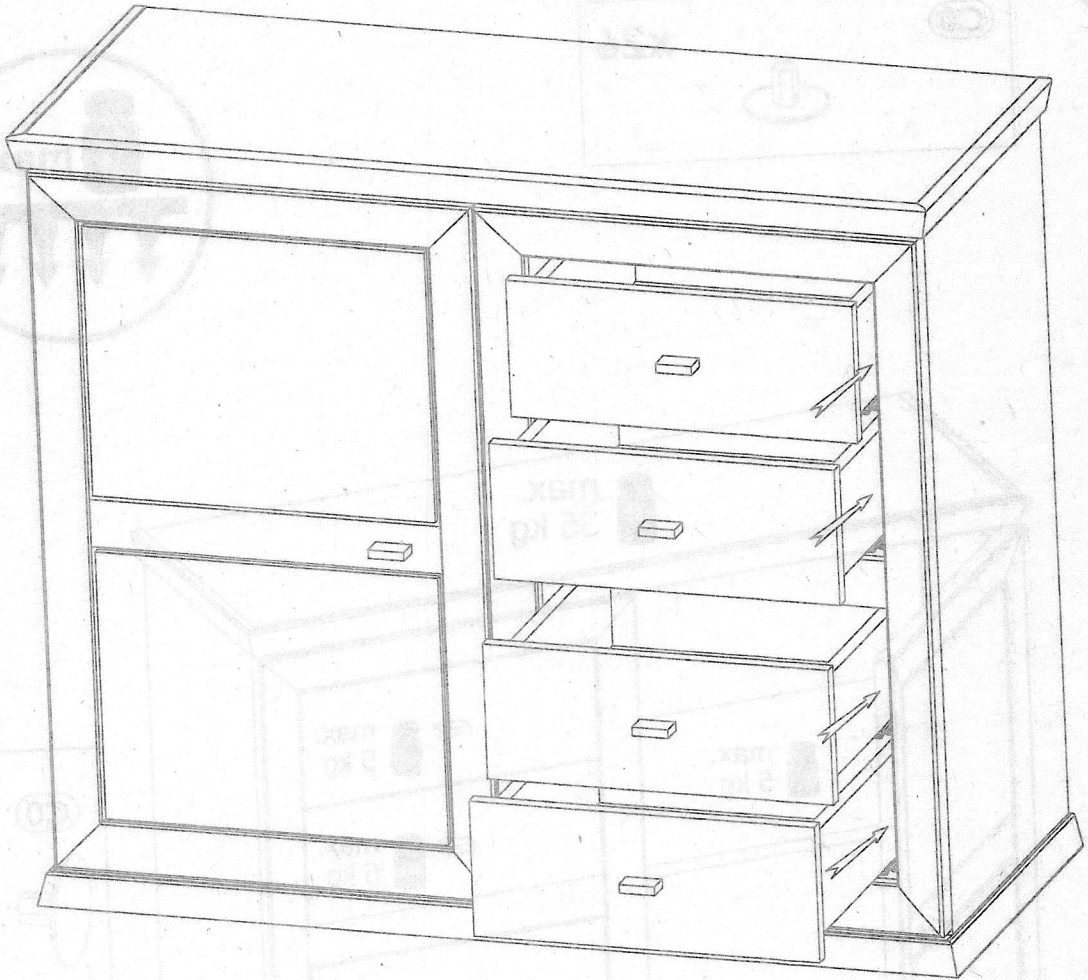

21 ▶

