

# MONTAGEANLEITUNG

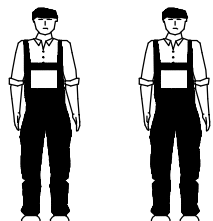

2 Pers. t= 30min

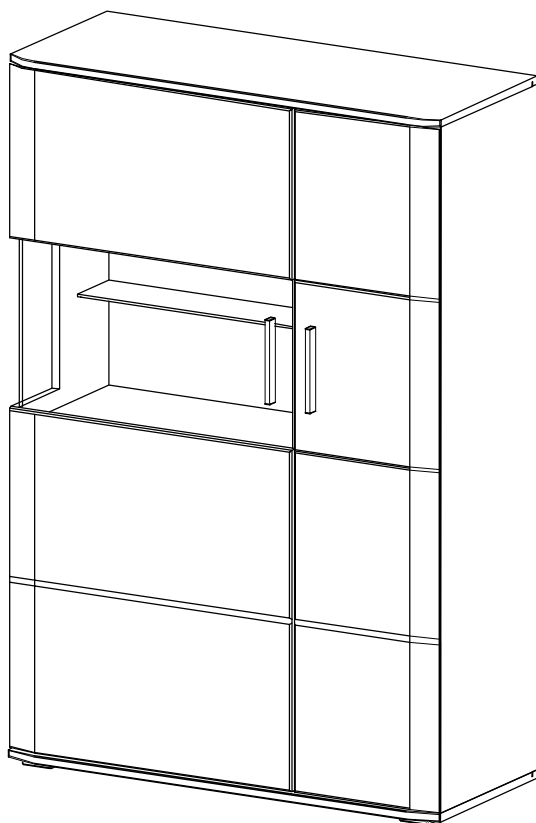
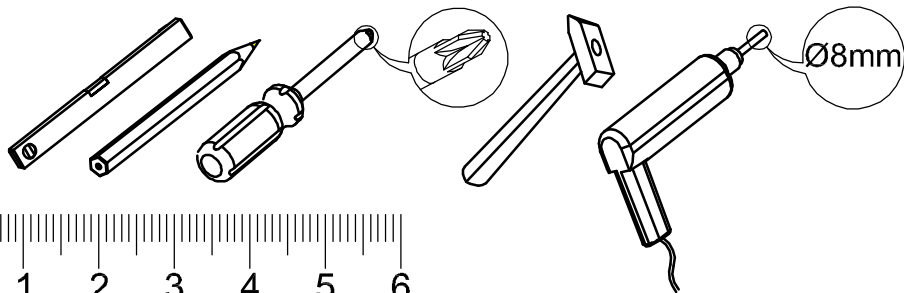

**HIGHBOARD R**  
(COX1QT21)

## BESCHLÄGLISTE

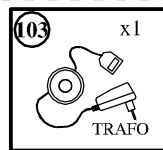
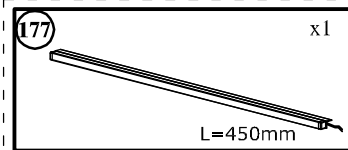
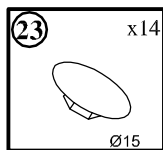
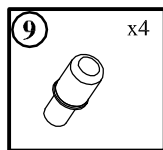
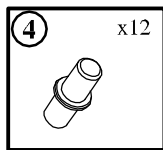
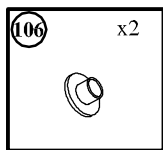
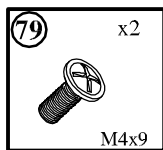
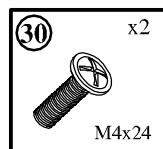
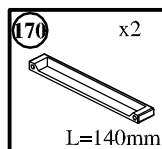
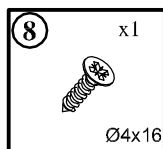
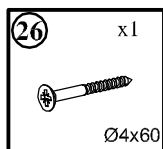
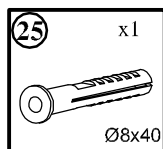
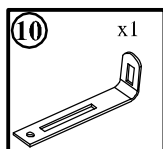
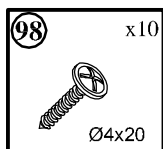
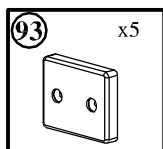

OPTION

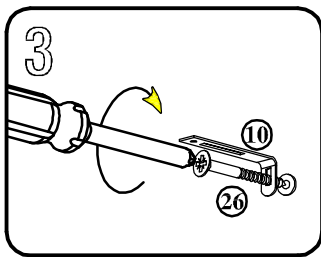
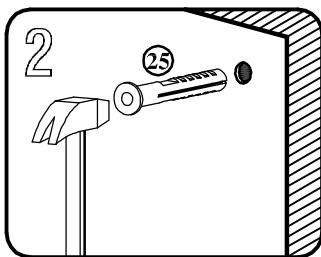
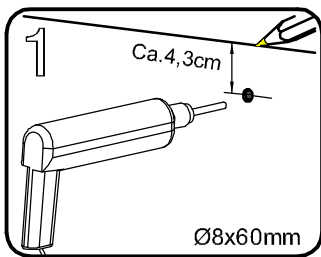
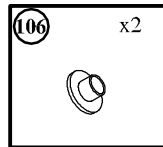
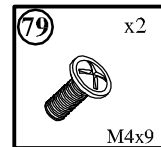
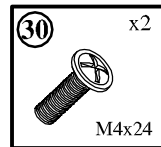
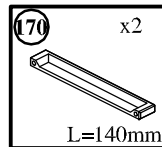
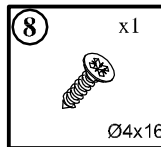
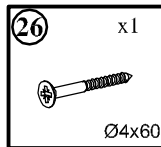
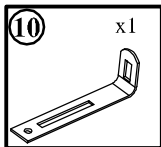
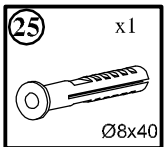
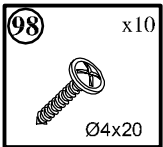
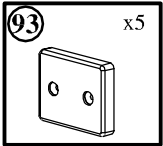
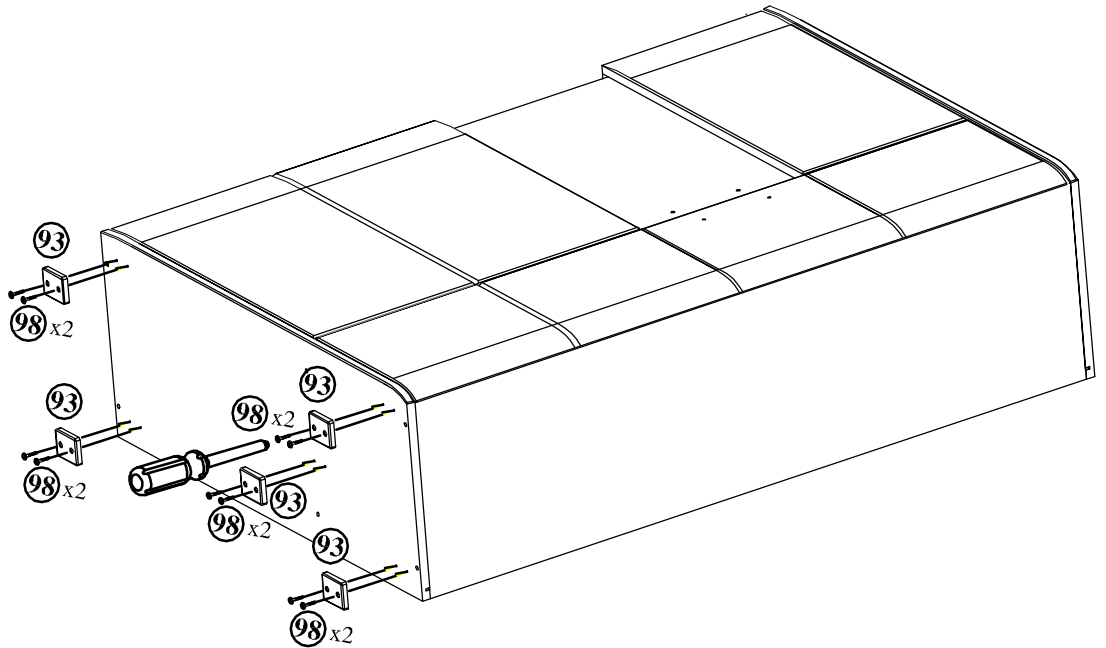
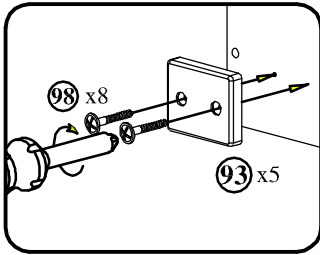

Die beigegefügt  
Dübel zum  
Aufhängen des  
Elements dürfen  
nur bei Betonwänden  
eingesetzt werden,  
bei anderen  
Wandarten müssen  
entsprechende Dübel  
zugekauft werden.

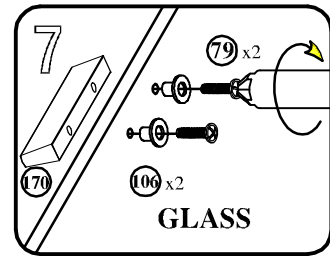
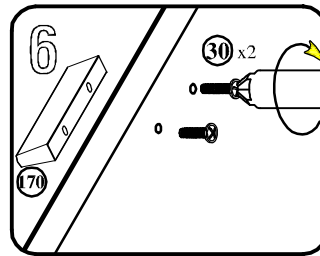
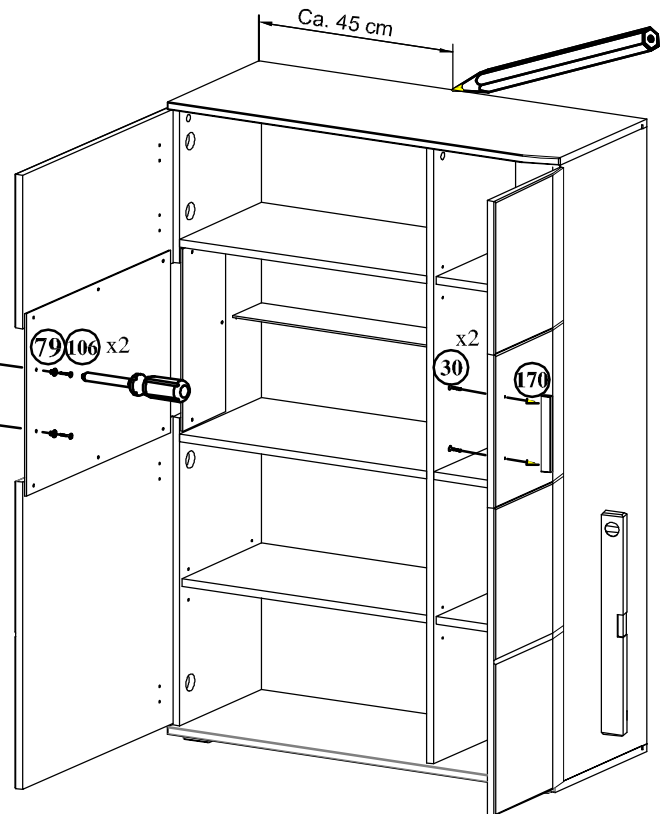
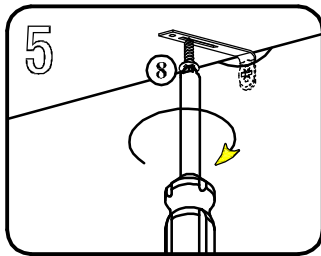

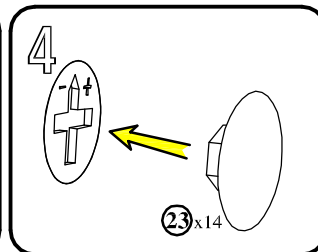
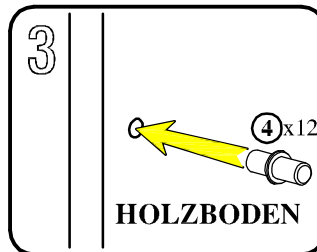
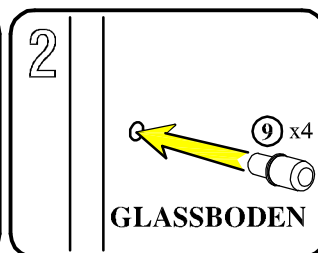
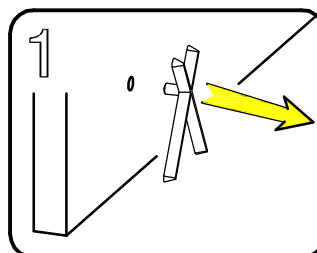
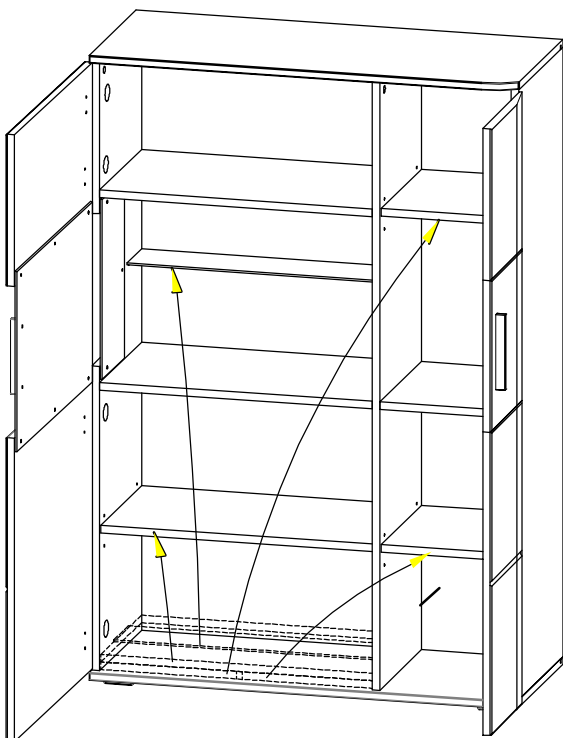
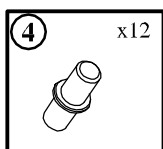
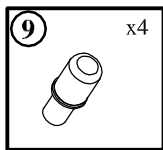
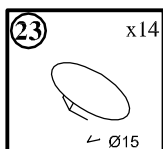

**Pflegehinweis !**

Bitte nur mit einem Staubtuch  
oder einem feuchten Lappen reinigen.  
**KEINE** scheuernde  
Putzmittel verwenden !

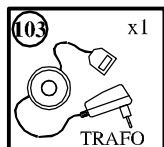
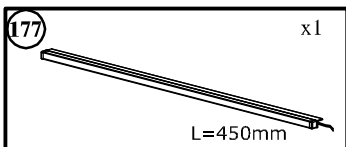

**OPTION**

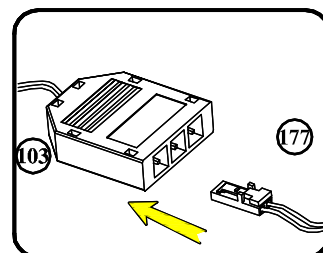
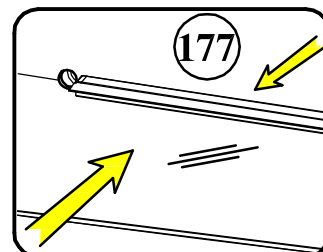
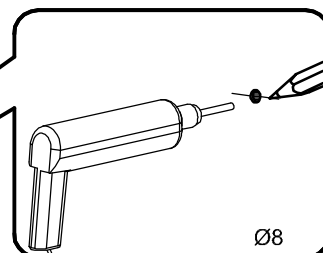
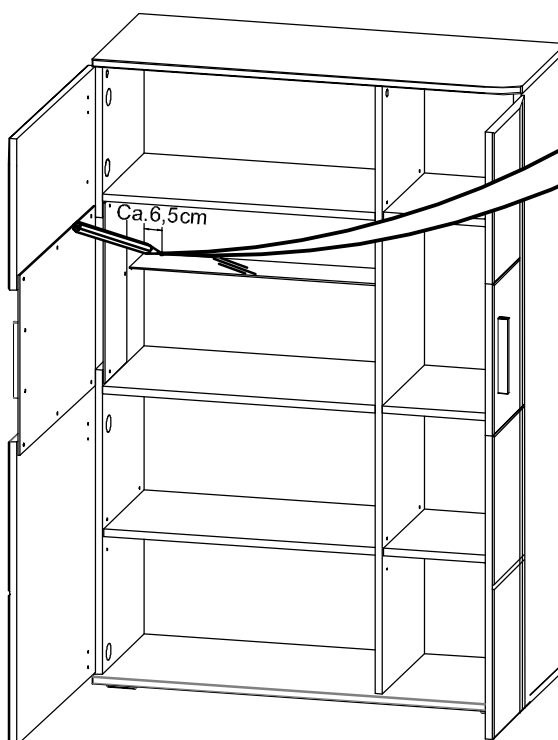

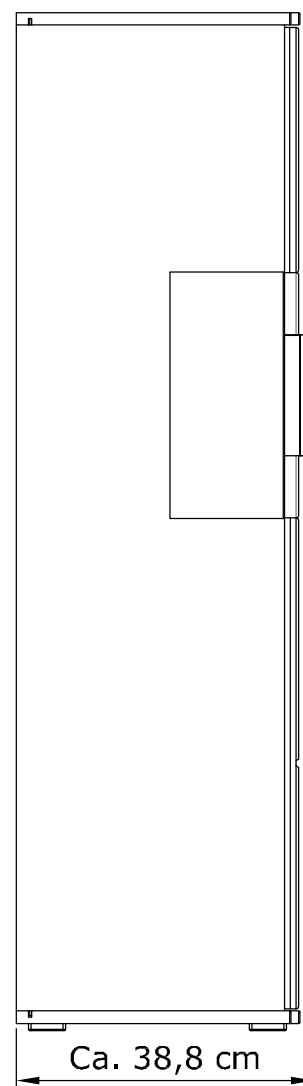
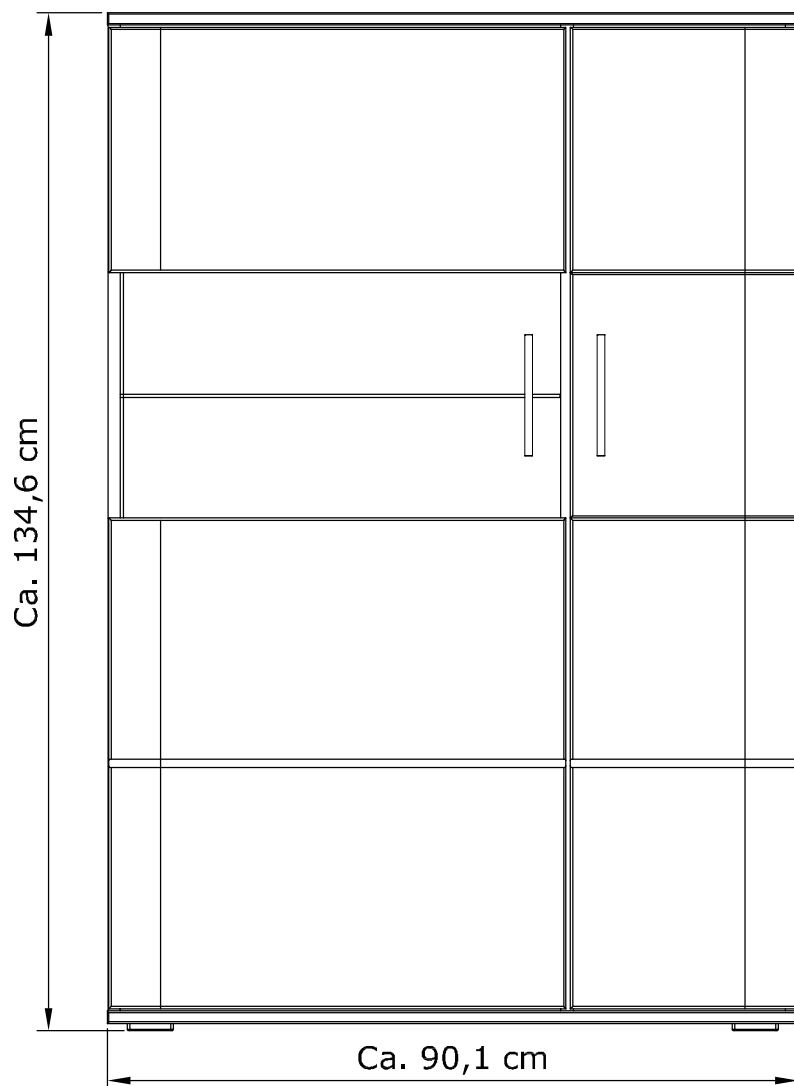

a)

**Fugenverstellung:**

Befestigungsschraube "A" lockern, gewünschte Fuge mit Schraube "B" einstellen. Schraube "A" anziehen.

b)

**Tiefenverstellung:**

Befestigungsschraube "A" lockern, Bandarm nach voren oder ruckwärts verschieben, Schraube "A" anziehen, Schraube "B" mit einer 1/4 Drehung nach rechts arretieren.

c)

**Hohenverstellung:**

Befestigungsschraube "C" lockern, Höhe einstellen, Schraube "C" anziehen.

## Verstellmöglichkeiten

