

T1 Bitte unbedingt ausfüllen!

Name _____

Strasse _____

Plz _____ Ort _____

Tel. _____



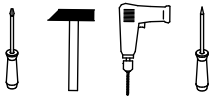





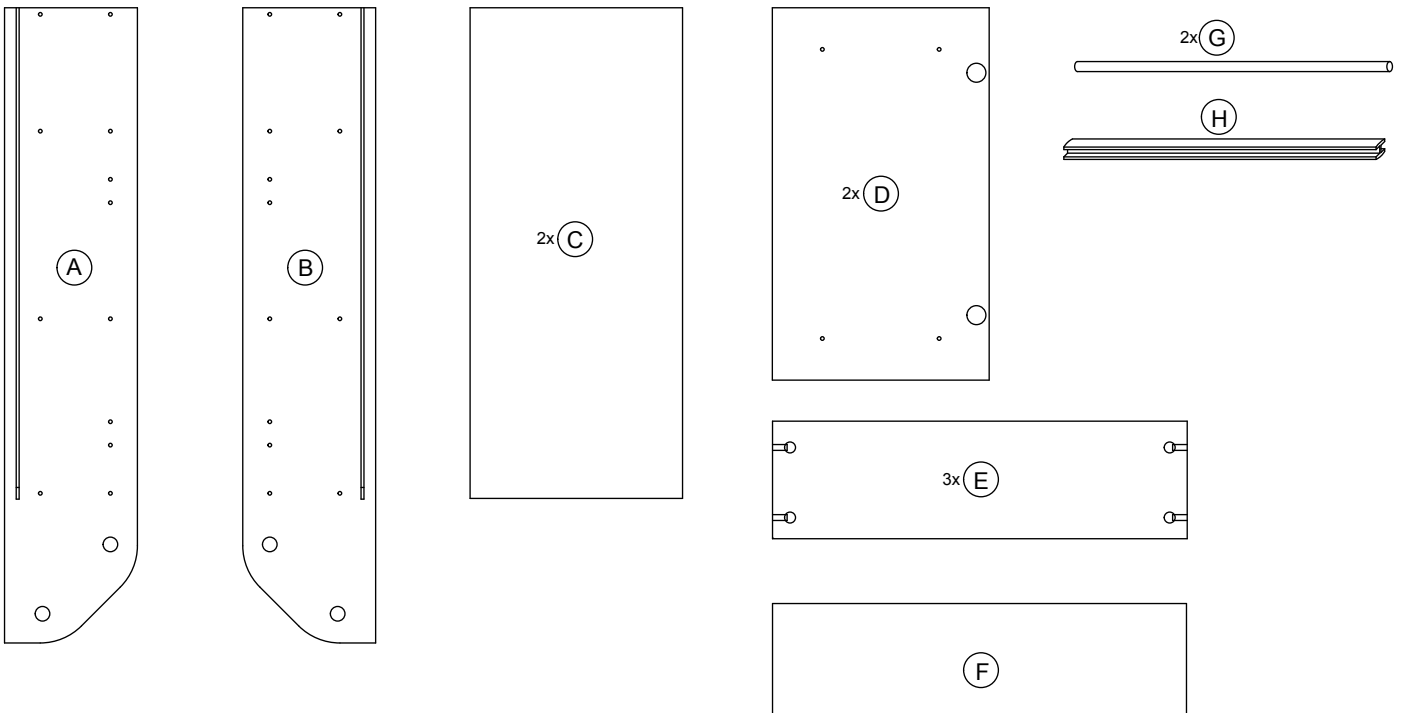

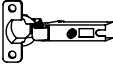

T2 Sehr geehrte Kunden,
wir freuen uns, dass Sie sich für ein Produkt aus dem Hause Pelipal entschieden haben. Sollte es trotz aller Bemühungen unsererseits, Ihnen ein qualitativ hochwertiges Möbelstück zu liefern, zu Fehlteilen kommen, schicken Sie bitte dieses ausgefüllte Blatt an
Fax.: **+49 3443/434354**
E-Mail: **weissenfels.ersatzteile@pelipal.de**
Bitte beachten Sie, dass Bauteile über 800mm Länge und 350mm Breite direkt bei Ihrem Möbelhändler zu beanstanden sind. Zur Reklamationsbearbeitung ist es unbedingt erforderlich **die Artikelnummer des Schrankes**, welche auf dem Etikett ersichtlich ist und den Markt, wo das Möbel erworben wurde anzugeben. Ausserdem tragen Sie unten bitte die benötigte Stückzahl ein. Viel Spass mit Ihrem neuen Badmöbel! Ihr Pelipal Team

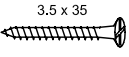

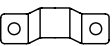
T3 Für den Zusammenbau sind 2 Personen erforderlich.

T4 Montage-Richtzeit 3 Stunden

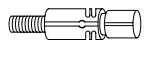

4 x a  ZPL-016X000	Stück	4 x b  TBD-26-115X00	Stück	8 x c  3,5 x 15 SCH-SPA-035X015	Stück	12 x d  EXZENTER-000015	Stück	MOT-Z0451S2 A4 Datum 04/08/08	
8 x e  NAGEL-025X001	Stück	4 x f  3,5 x 35 SCH-SPA-035X035	Stück	2 x g  AUF-001-000020	Stück	2 x i  AUF-001-000010	Stück		
4 x j  TRÄ-001-000020	Stück	2 x k  GRI-160-335010	Stück	4 x l  M4 x 24 SCH-KNO-M04X024	Stück	12 x m  DÜB-SMD-000005	Stück	4 x n  5 x 8 ADK-AL1-005X008	Stück

1.

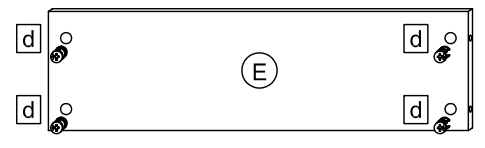
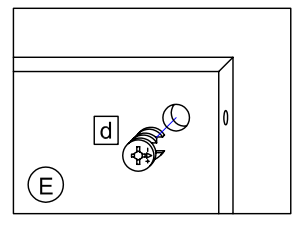
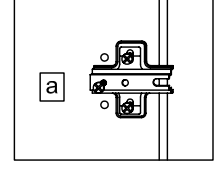
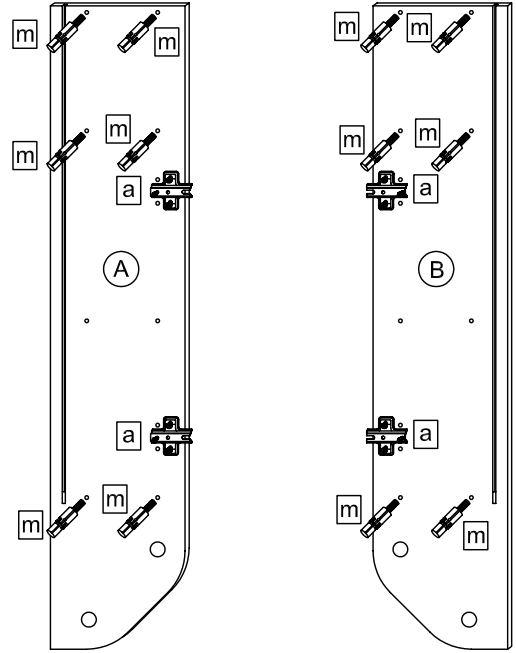
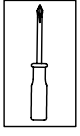

2.

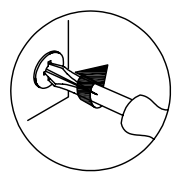
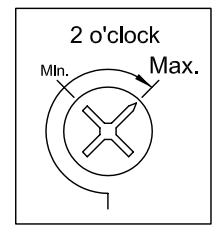
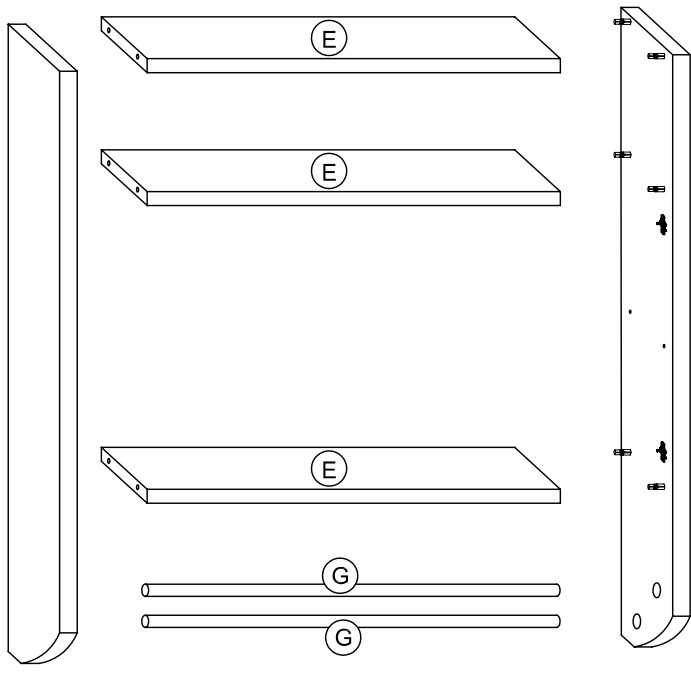
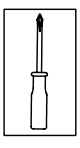

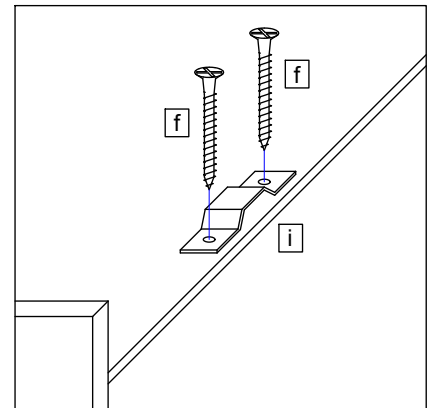
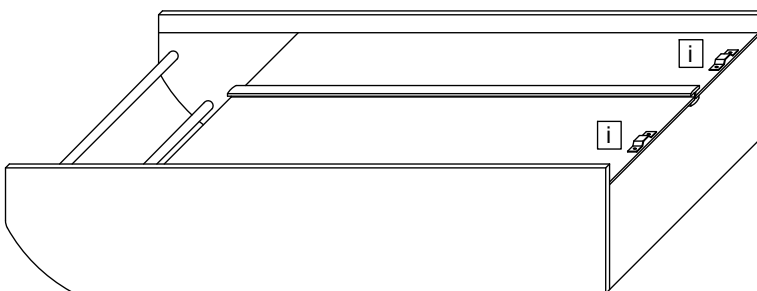
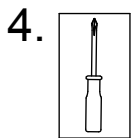
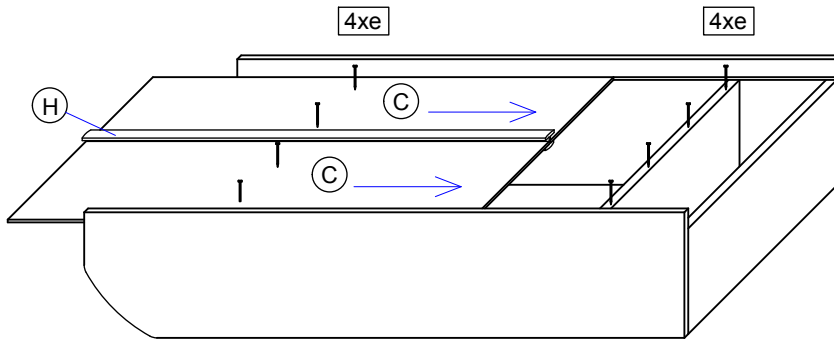
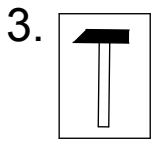

Das Etikett, welches sich unten rechts befindet bitte ausschneiden und auf der Rückwand mit Klebeband (nicht beiliegend) befestigen.

PELIPAL GmbH
Industriestrasse 2

33189 Schlangen

6.

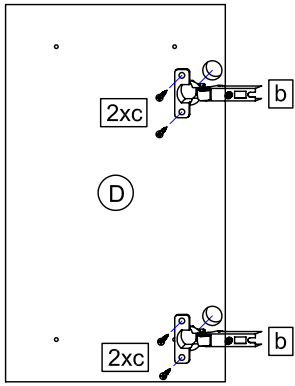
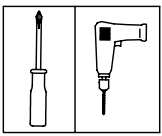

7.

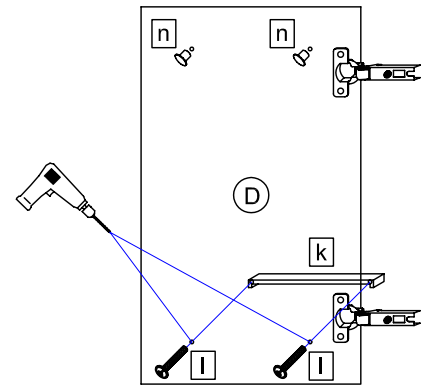
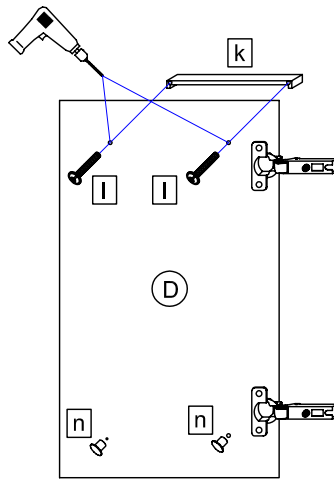
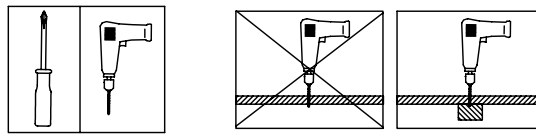

8.

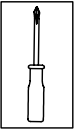

T9 Lassen Sie den Schrank nur durch fachkundige Personen mit für die Wand geeignetem Montagematerialien montieren.

T8 Wand

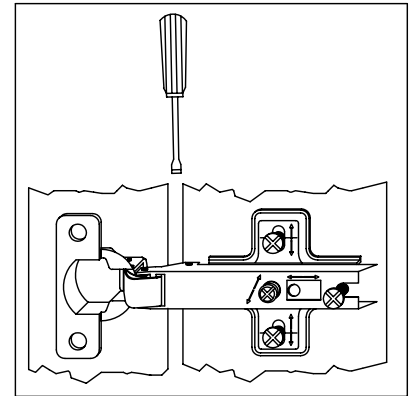
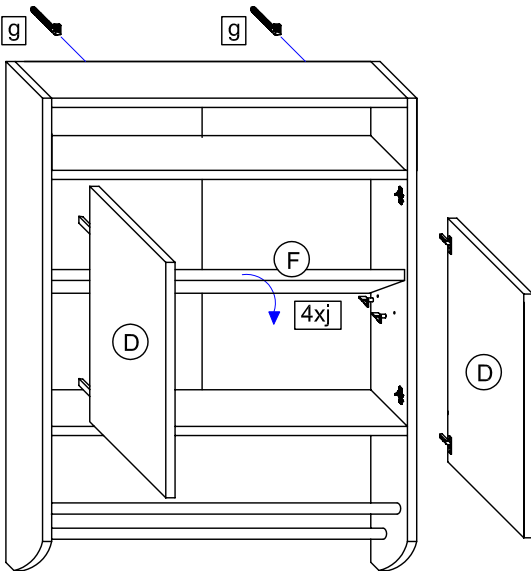

T11 Bei Türmontage das Scharnier einhängen, bis Anschlag öffnen und anschließend festschrauben.

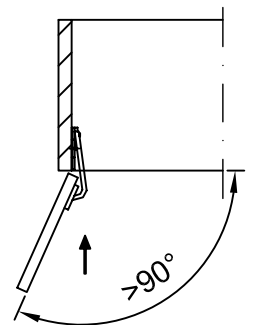

T12 Das Möbel bitte nur mit einem feuchten Tuch reinigen.