

MONTAGEANLEITUNG

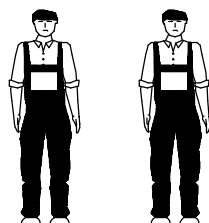

2 Pers. t= 30min

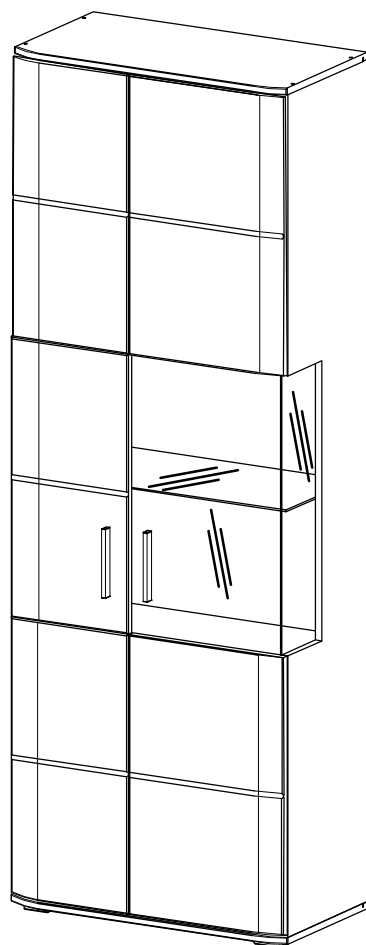
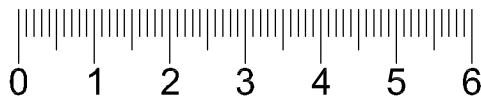
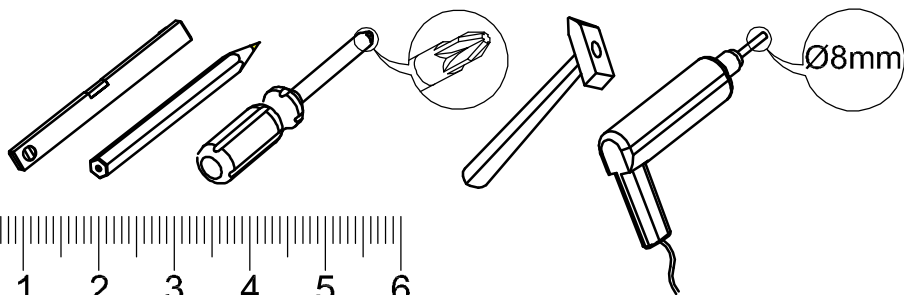

VITRINE L.
(COX1QT10)

BESCHLÄGLISTE

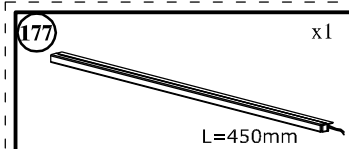
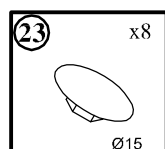
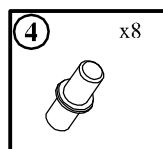
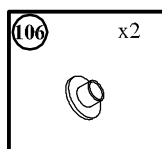
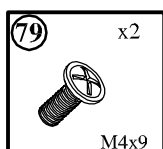
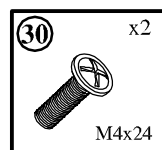
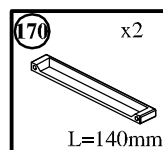
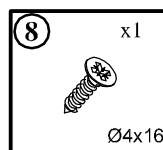
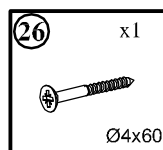
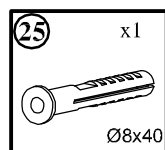
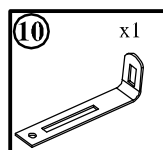
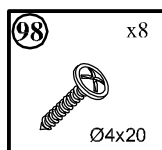
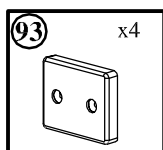

OPTION

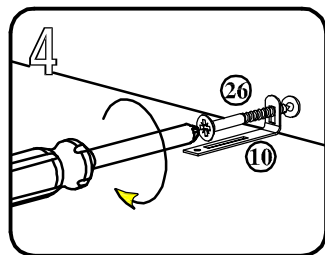
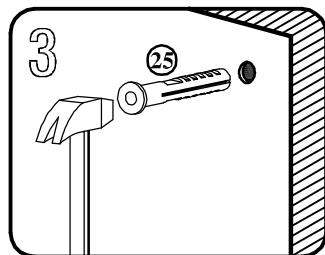
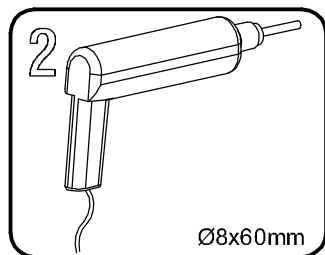
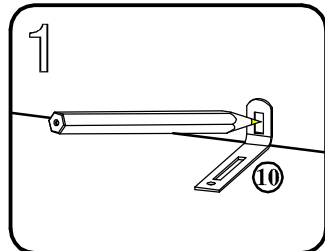
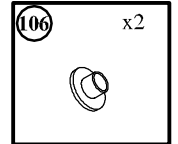
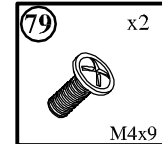
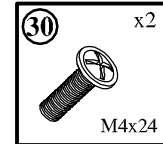
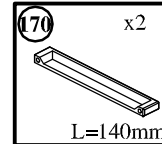
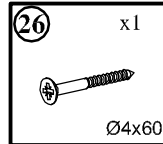
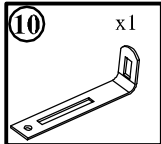
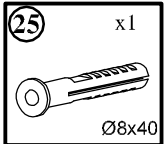
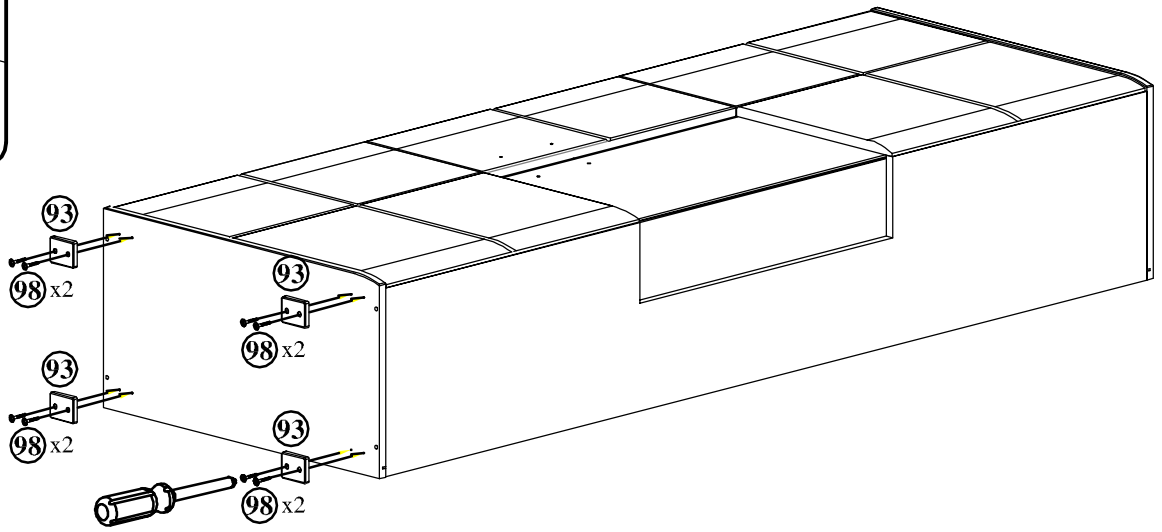
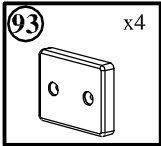
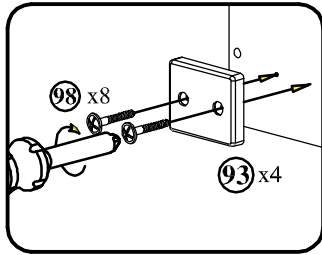

Die beigefügten Dübel zum Aufhängen des Elements dürfen nur bei Betonwänden eingesetzt werden, bei anderen Wandarten müssen entsprechende Dübel zugekauft werden.

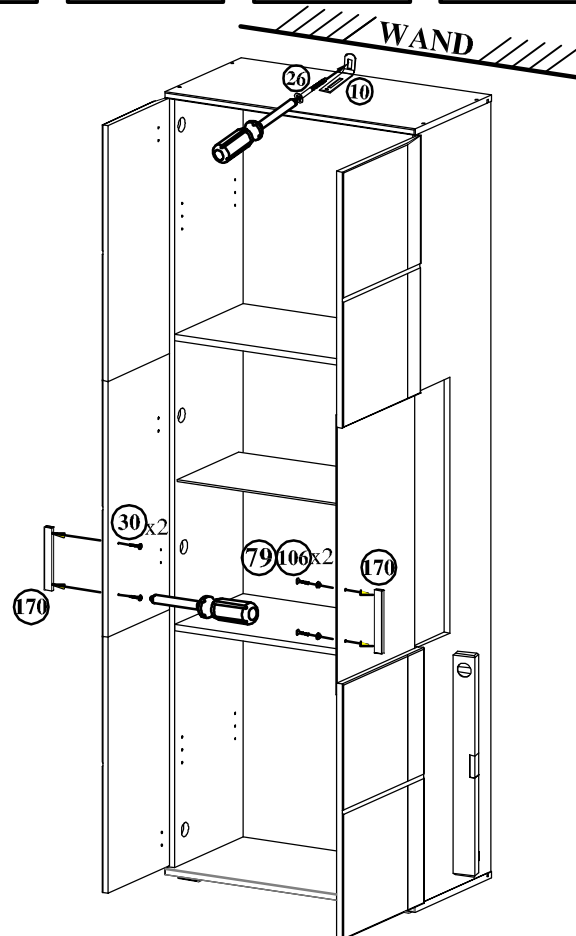
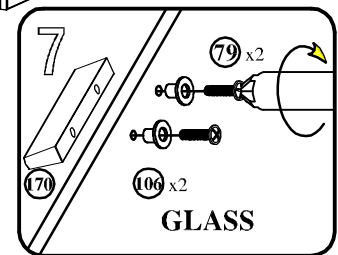
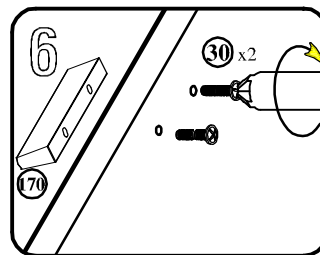
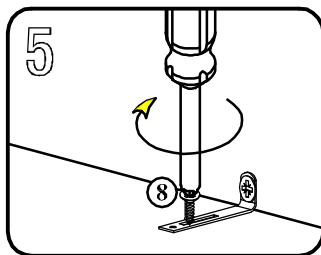

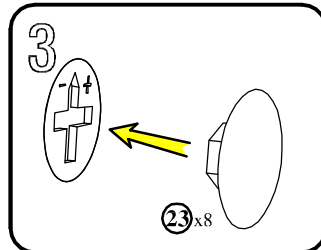
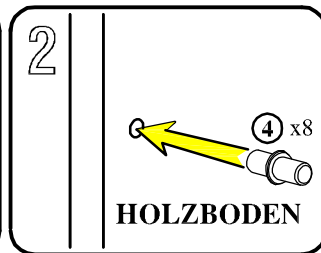
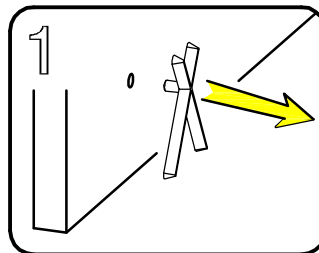
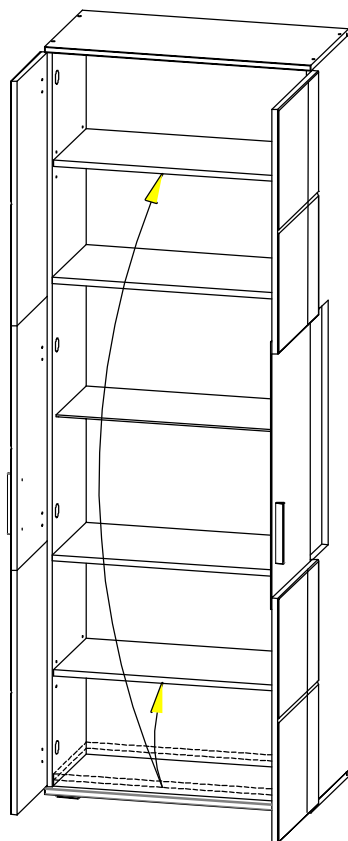
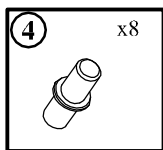
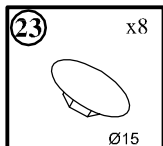

Pflegehinweis !

Bitte nur mit einem Staubtuch oder einem feuchten Lappen reinigen.
KEINE scheuernde Putzmittel verwenden !

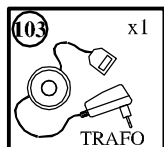
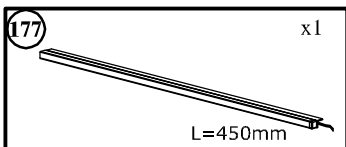

OPTION

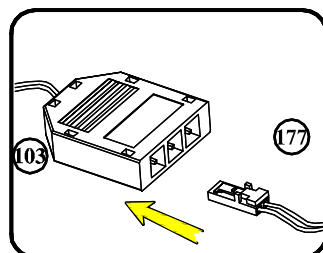
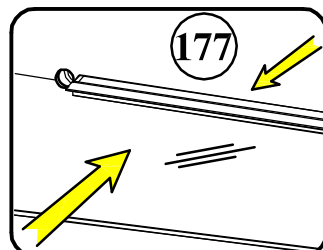
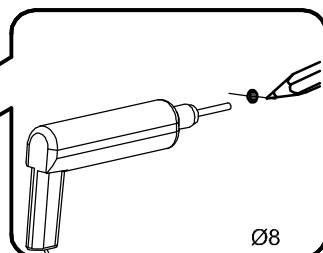
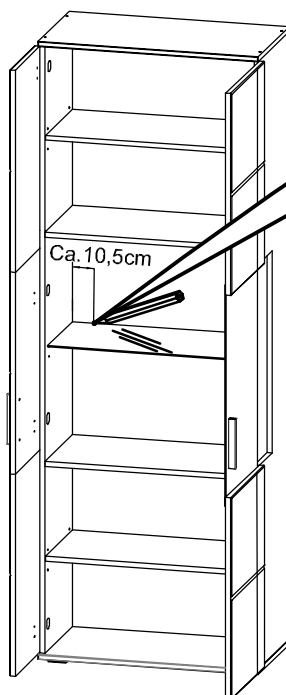

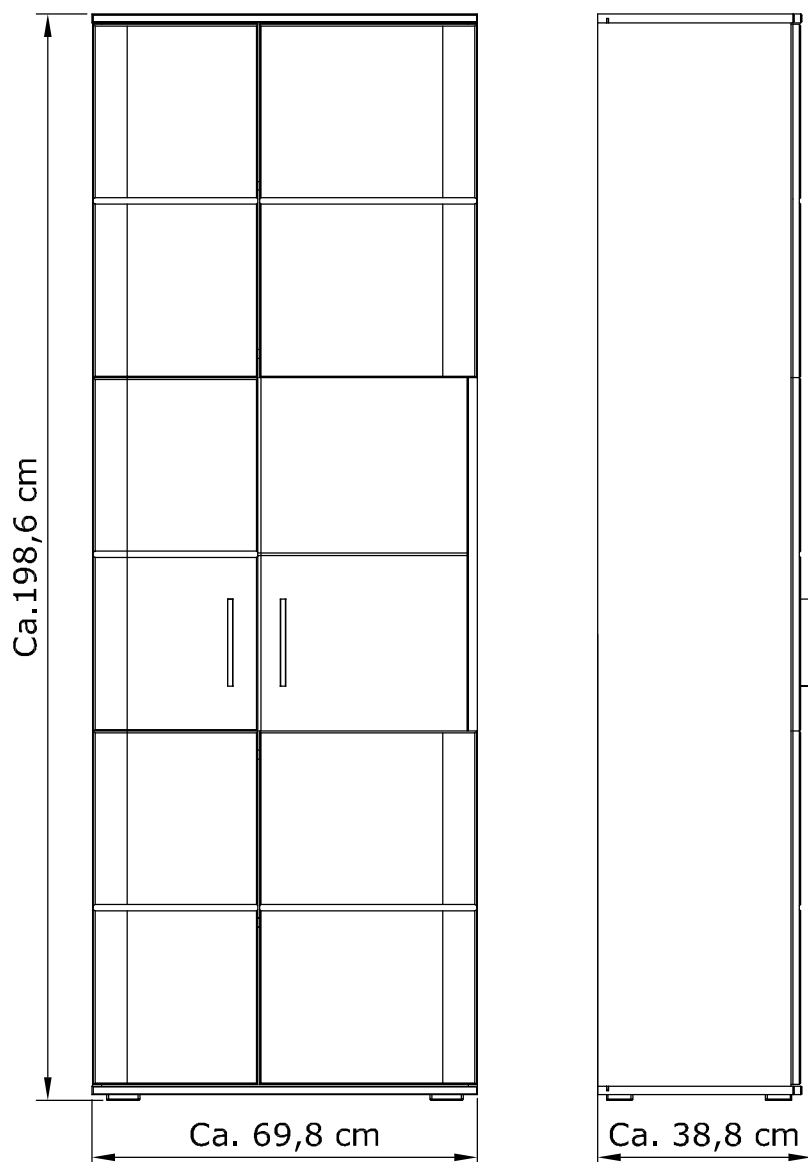

a)

Fugenverstellung:

Befestigungsschraube "A" lockern, gewünschte Fuge mit Schraube "B" einstellen. Schraube "A" anziehen.

b)

Tiefenverstellung:

Befestigungsschraube "A" lockern, Bandarm nach voren oder ruckwärts verschieben, Schraube "A" anziehen, Schraube "B" mit einer 1/4 Drehung nach rechts arretieren.

c)

Hohenverstellung:

Befestigungsschraube "C" lockern, Höhe einstellen, Schraube "C" anziehen.

Verstellmöglichkeiten

