

16340150-01/02

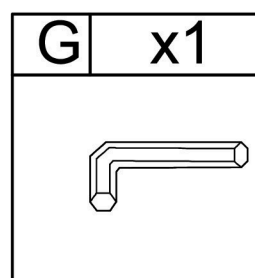

BDSK Handels GmbH & Co. KG
Mergentheimer Straße 59
DE-97084 Würzburg Germany

TWAIN

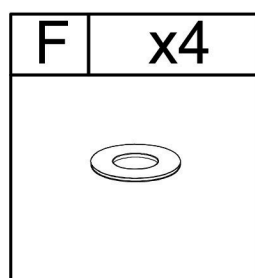
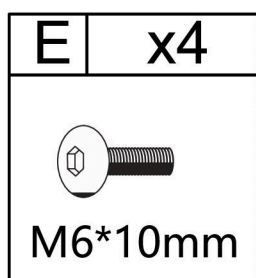
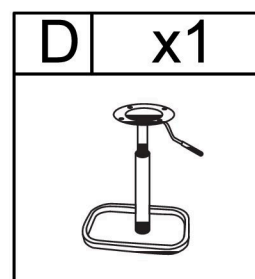
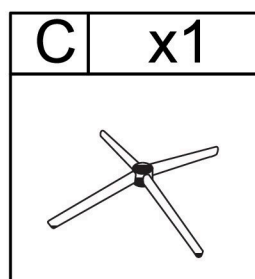
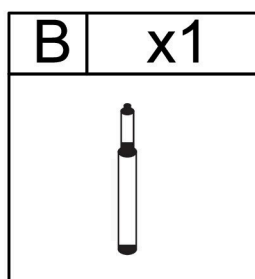
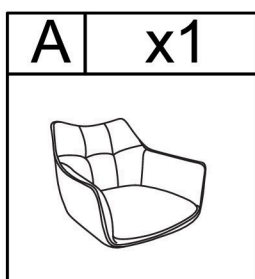
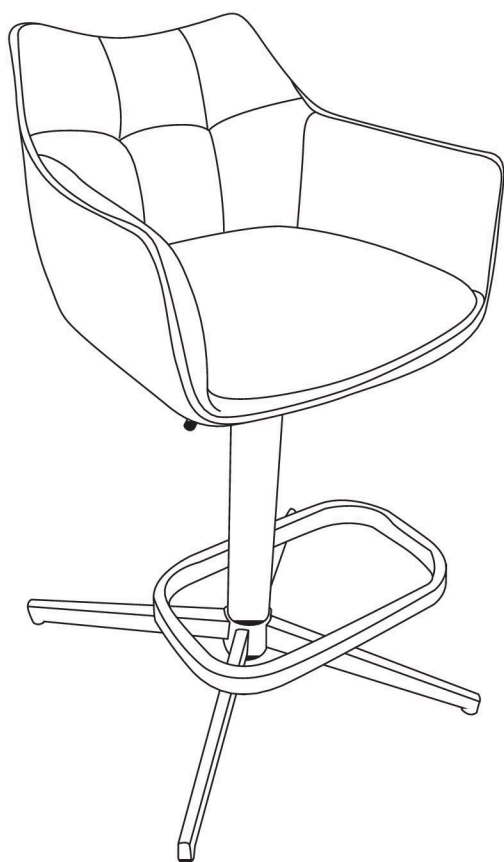

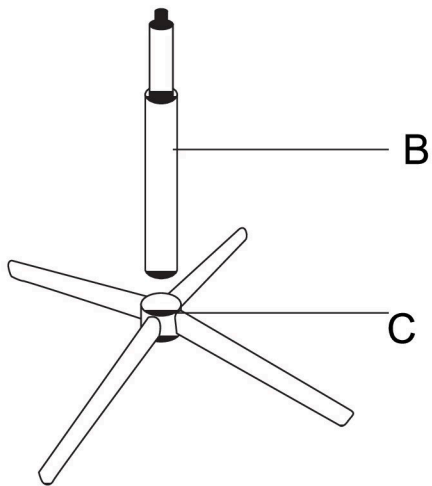

1



B	x1	C	x1
			

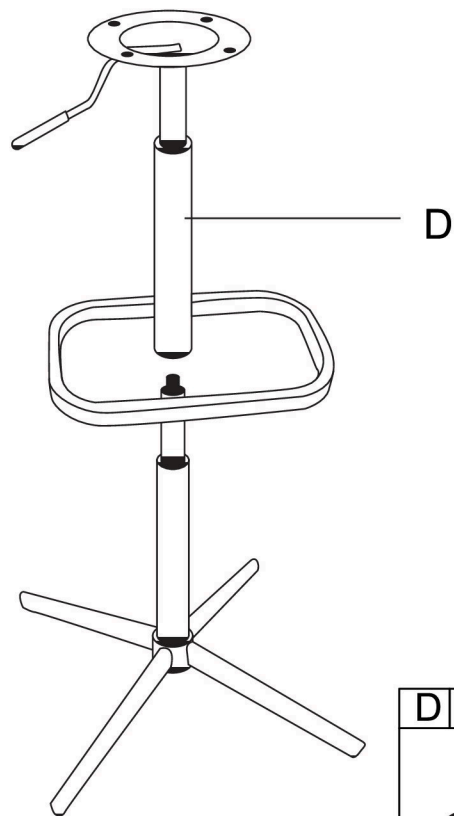



2

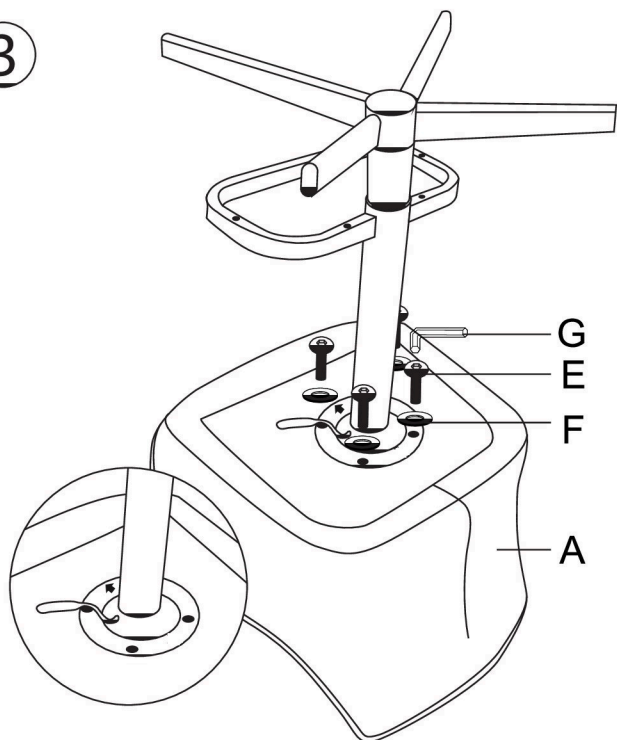

D	x1
	

3



A	x1	E	x4	F	x4	G	x1
		 M6*10mm					

4

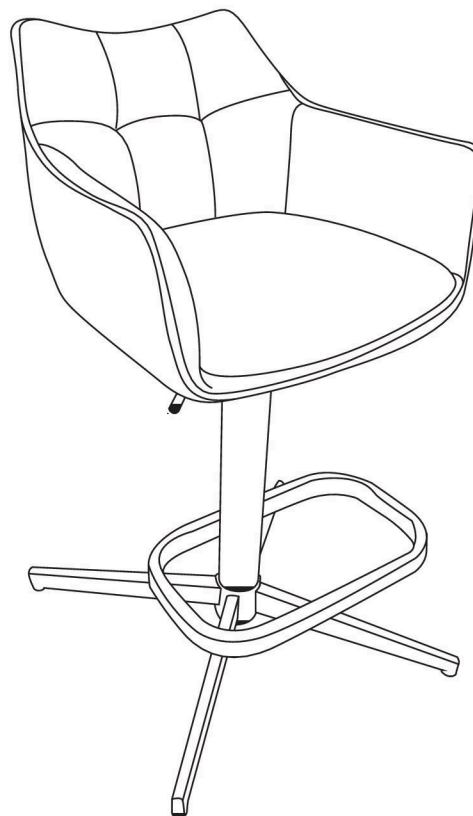

Gas lift TUV / Class 3

