

# "P223 Menorca T"

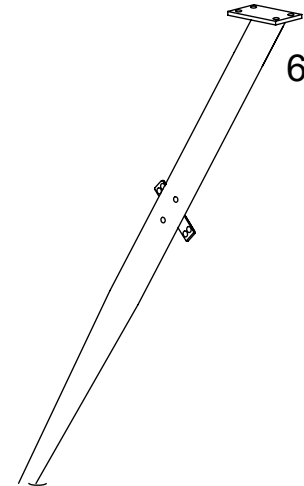

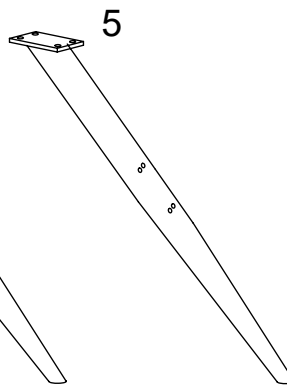

1	1 x	1/2
2	1 x	2/2
3	1 x	2/2
4	1 x	2/2
5	1 x	2/2
6	1 x	2/2

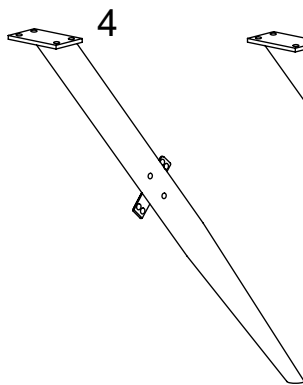
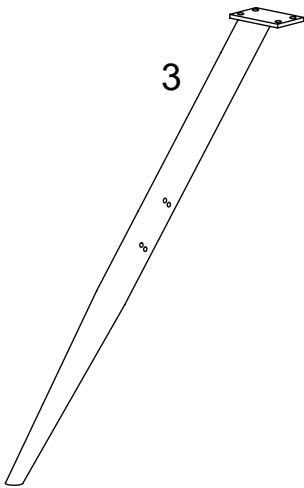
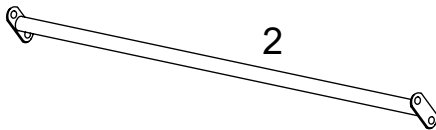
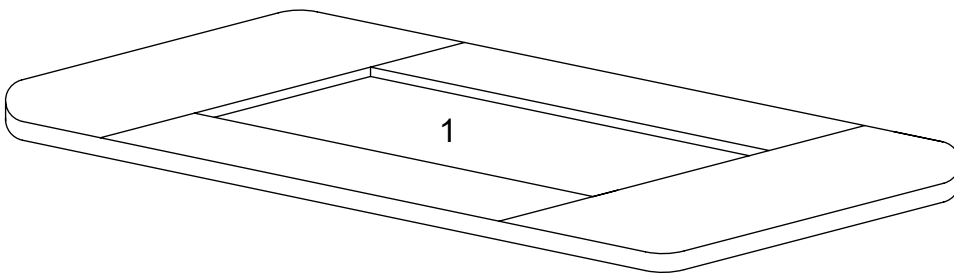
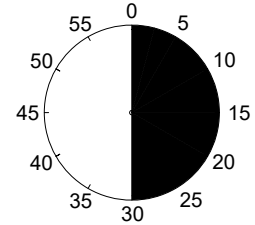
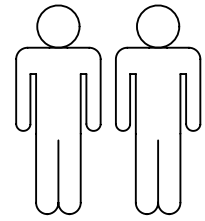
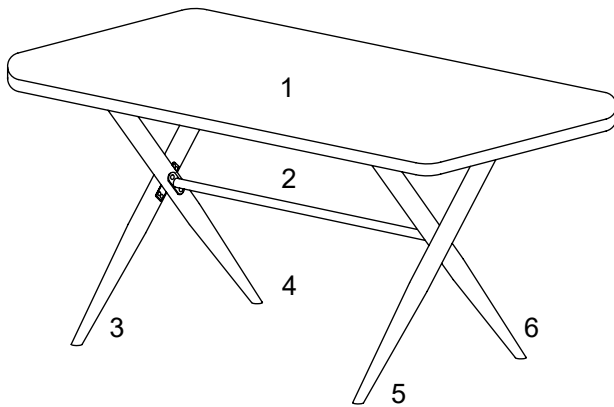
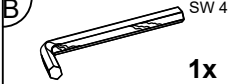
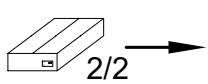
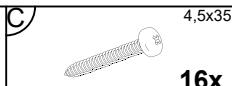
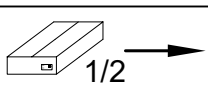

I.

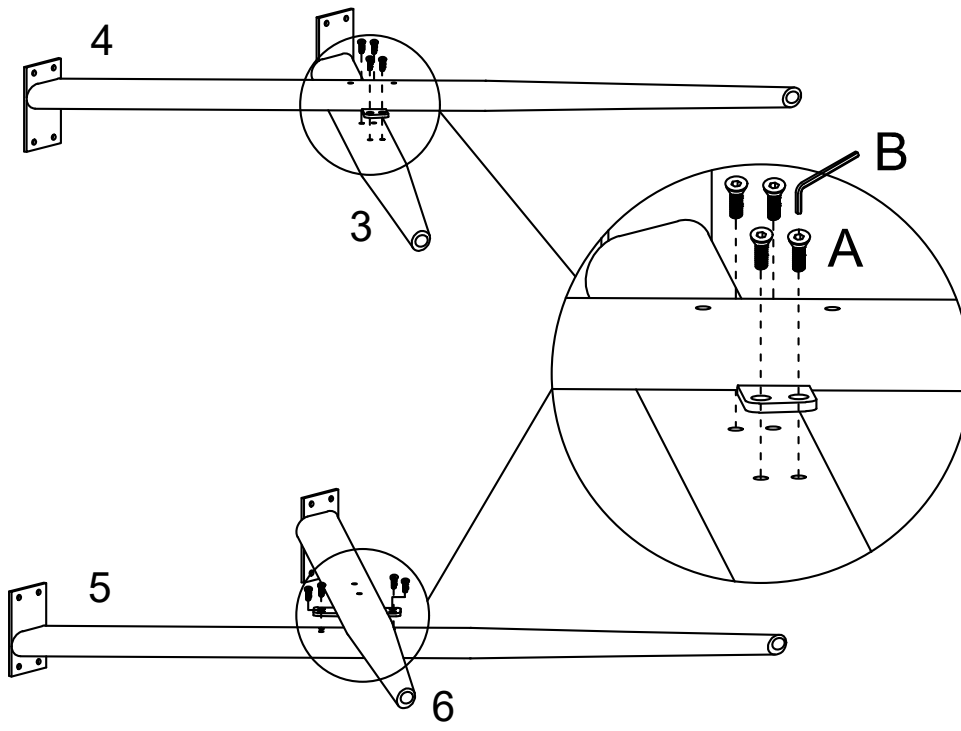
1.



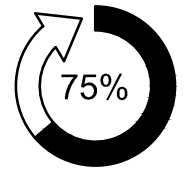

A		M6x18
		<b>8x</b>
B		SW 4
		<b>1x</b>

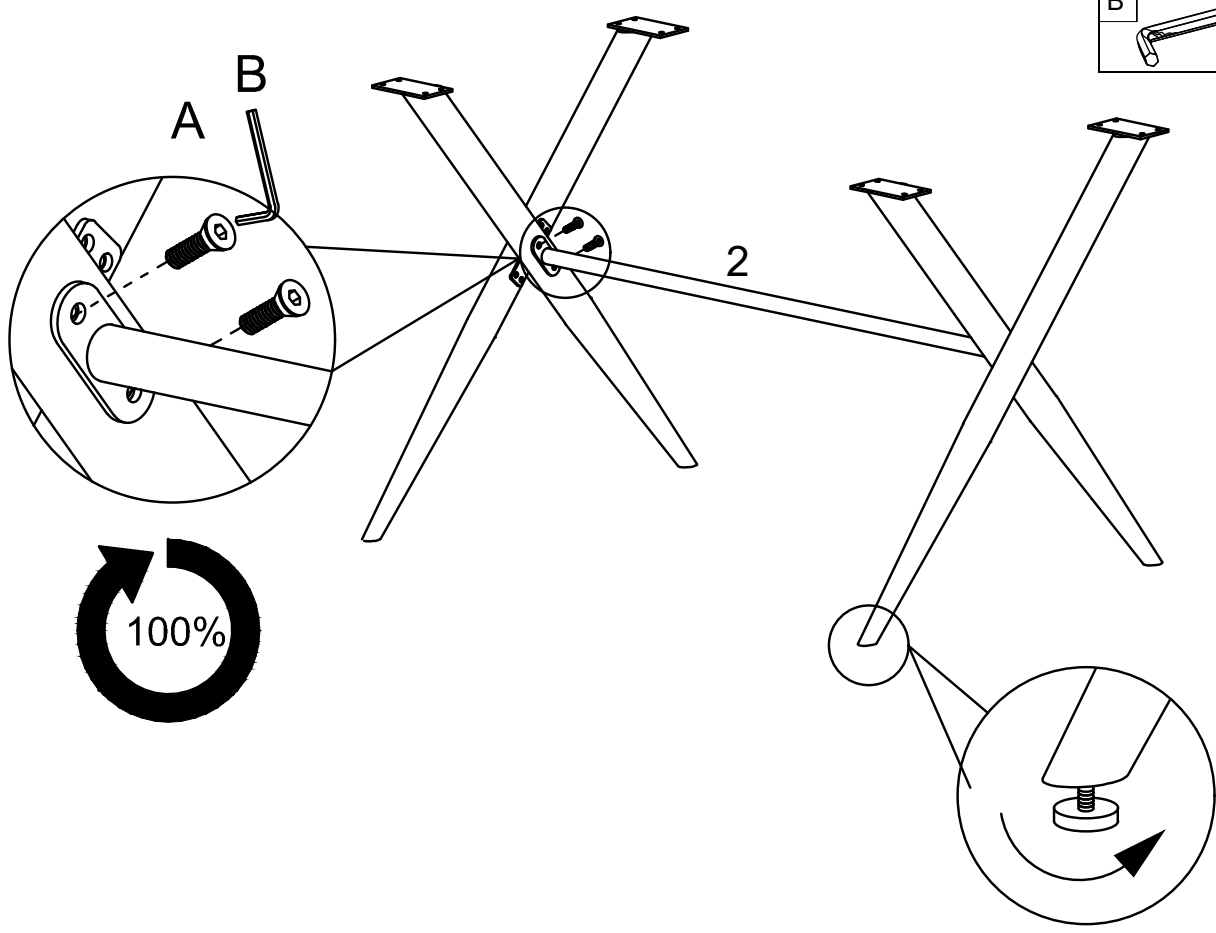

2.



A		M6x18
		<b>4x</b>
B		SW 4
		<b>1x</b>

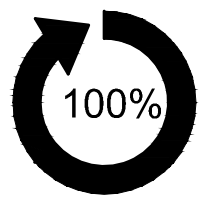

II.

C 4,5x35  
16x

3.

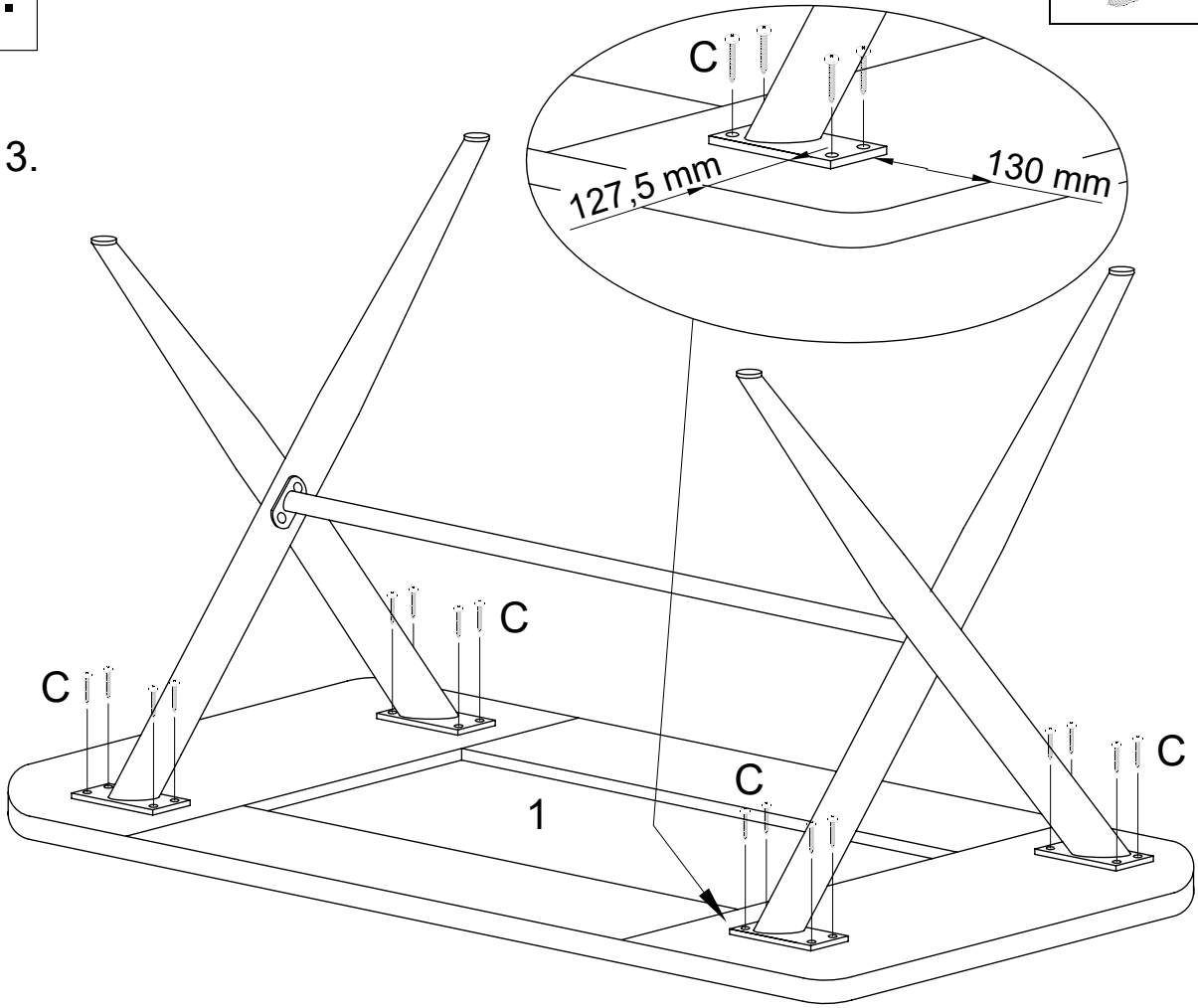

4.

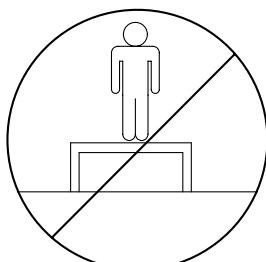
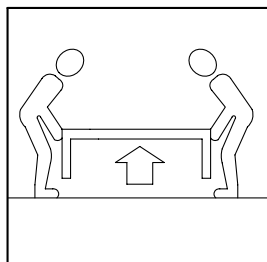
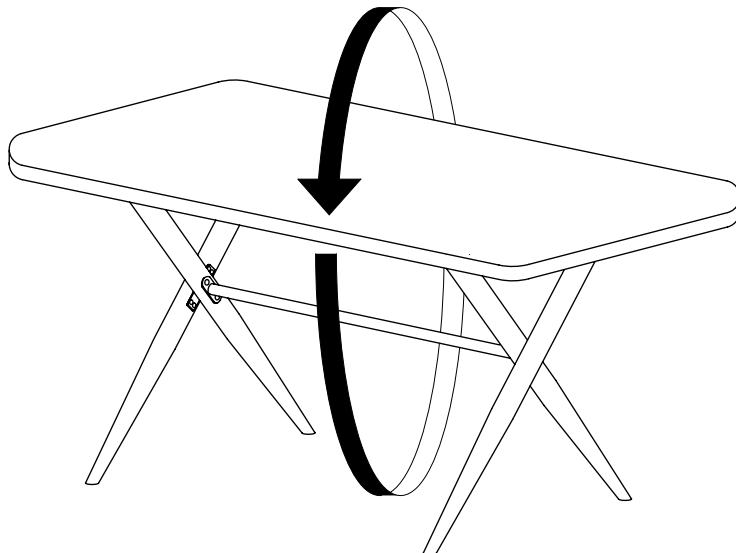
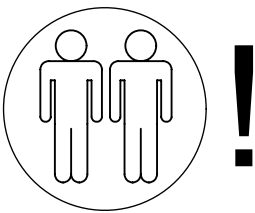

LE TRI  
+ FACILE



Séparez les éléments avant de trier