

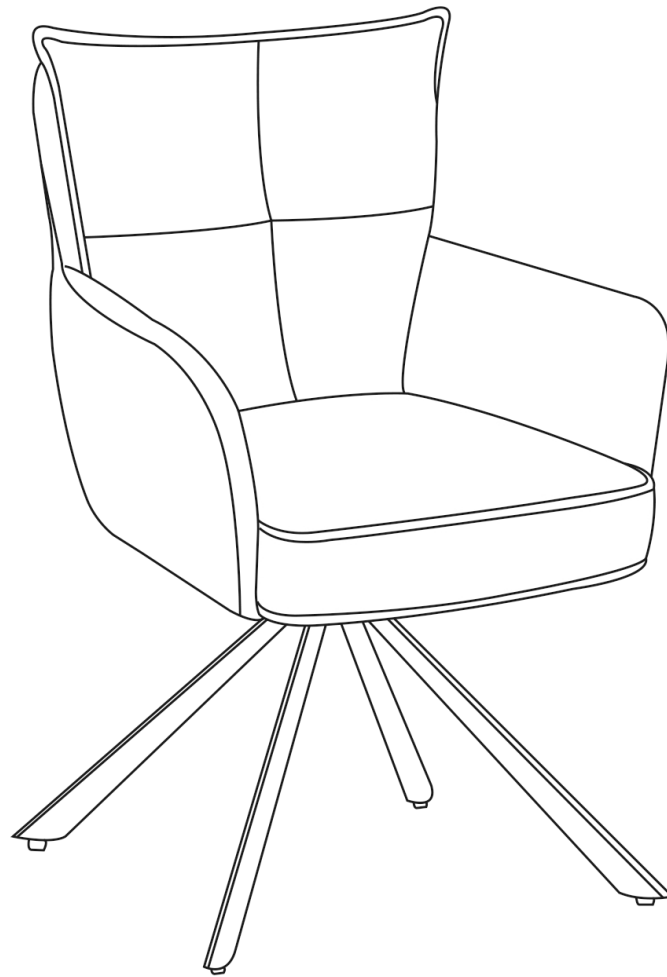





SEBA STUHL

MONTAGEANLEITUNG

ARTIKEL:1858

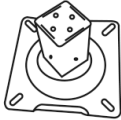

A	B	C	D	E	F
	 M6*16mm				 M6*12mm
x1	x8	x1	x1	x4	x4

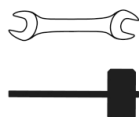
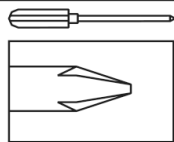

30 Min.



Das Zeichen für verantwortungsvolle Waldwirtschaft



SEBA STUHL

MONTAGEANLEITUNG

ARTIKEL:1858

1

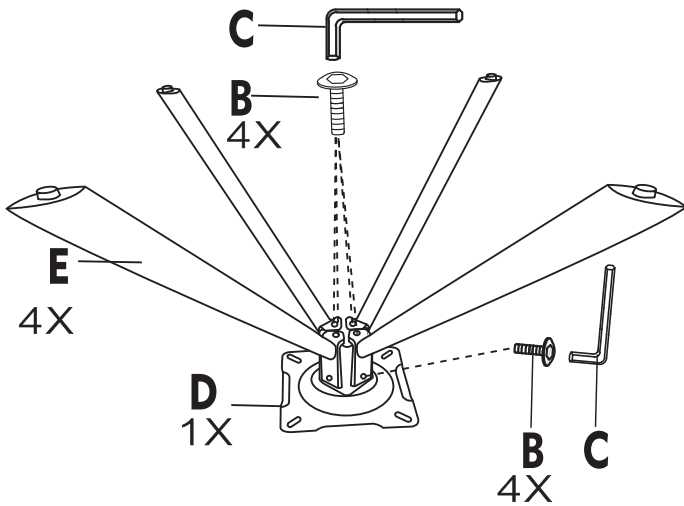

2

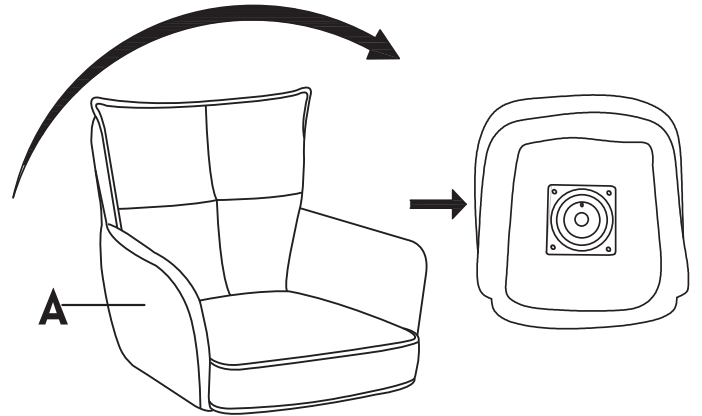

3

