

Service

Name	ASSINI
Typ	T 60 - ESSTISCH

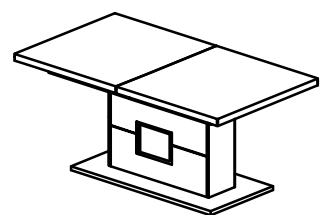

- ①a ①b 1000×900×28 - 2 stk.
- ② 1000×500×28 - 1 stk.
- ③ 1080×732×25 - 1 stk.
- ④ 610×696×200 - 1 stk.
- ⑤ 1080×68×20 - 2 stk.
- ⑥ 590×107×20 - 4 stk.
- ⑦ 768×107×20 - 2 stk.
- ⑧ 1100×550×25
- ⑨ 60x60x20 - 6 stk.

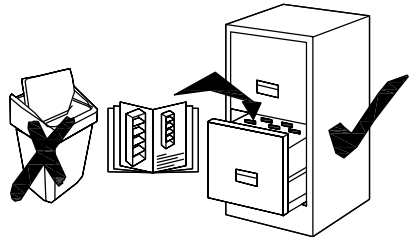
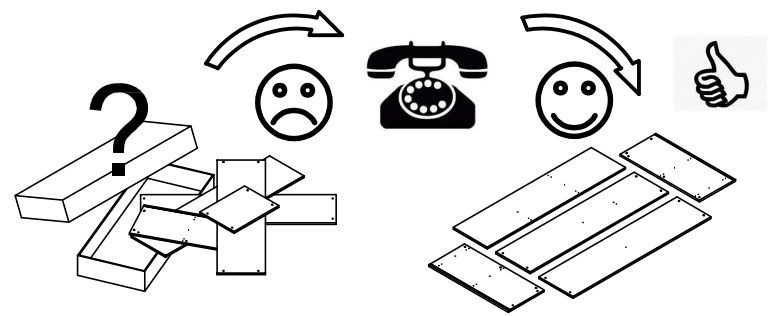
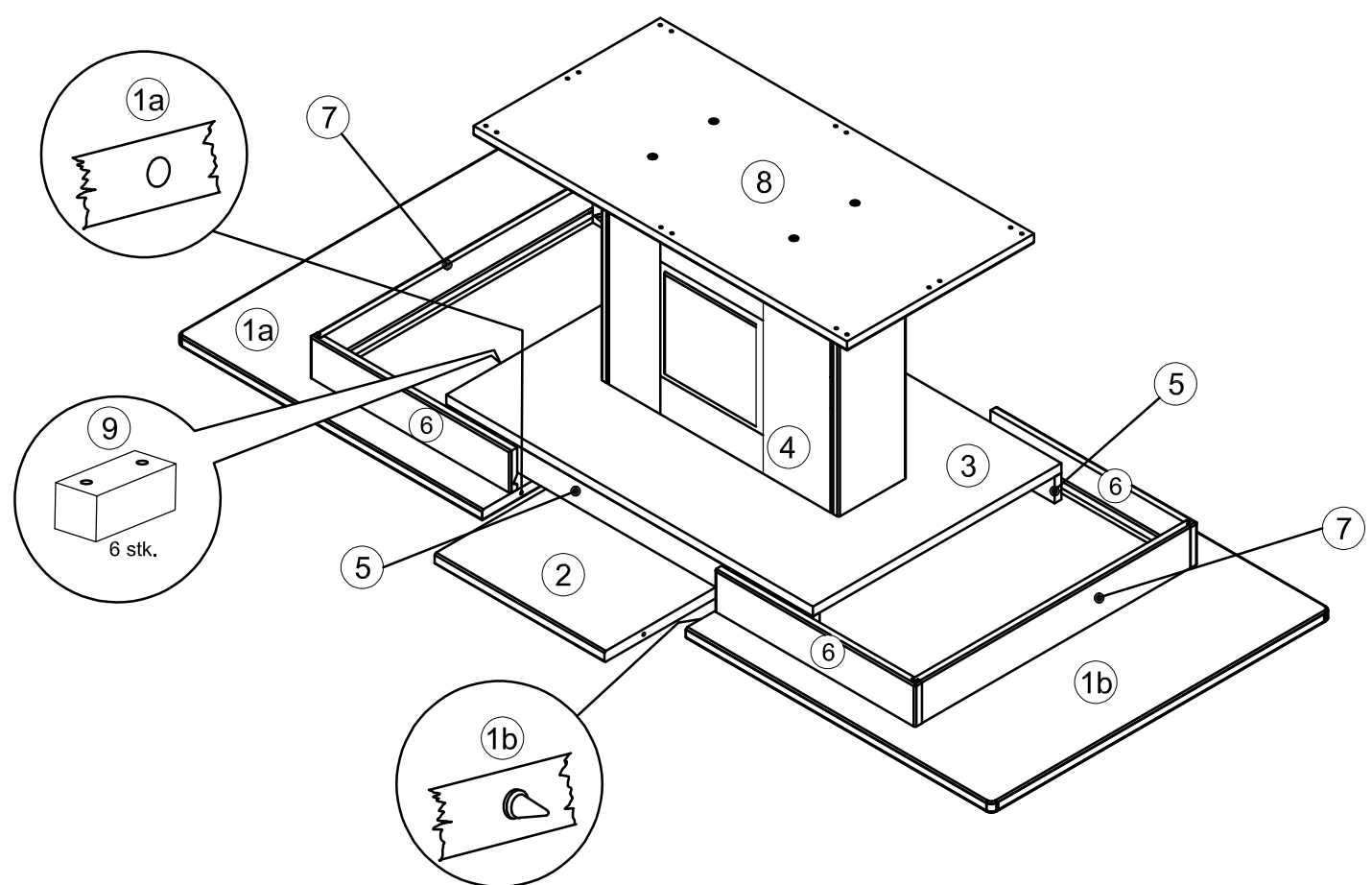

D1 Ø8x32 mm 	FI 25x25x3mm 	S M8x40mm 	KS 42x20x20
S1-16 3x16 mm 	S3-70 5x70 mm 	CL SISO 	SW 5 mm
S2-16 4x16 mm 	S-35 3,5x35 mm 	S2-45 4x45mm 	L1
			V L=980mm

Modellname: **ASSINI**

MONTAGEANLEITUNG

TYPE T60 - ESSTISCH

17.11.2023.

1/1

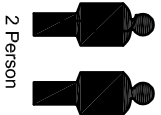

2 Person

20
Min.

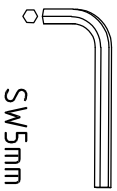

SW5mm

2.

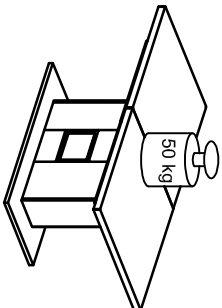

9

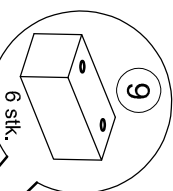

S=4x

3.

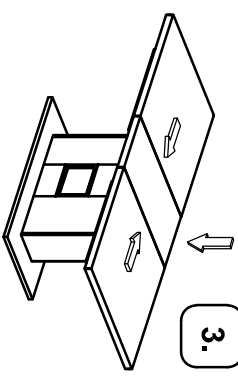

4.

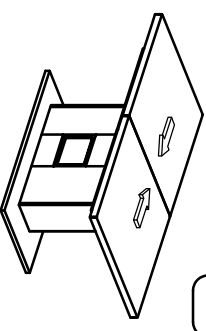

1.

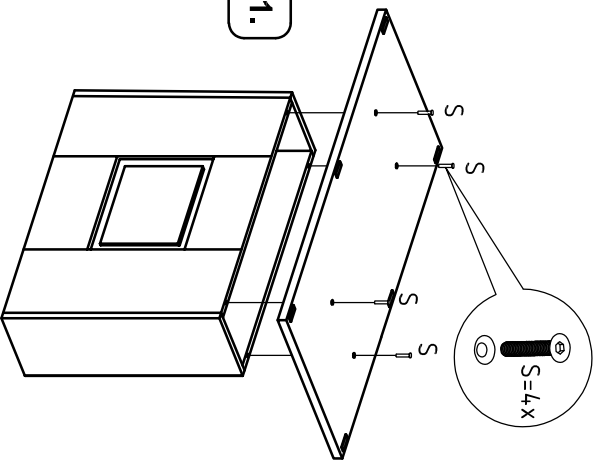

button

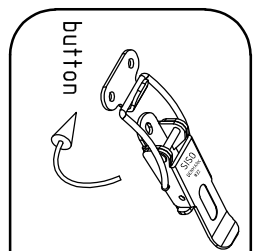

button

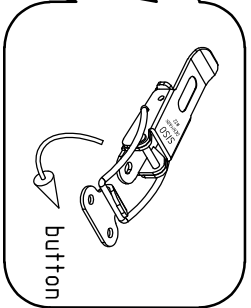

F=6x

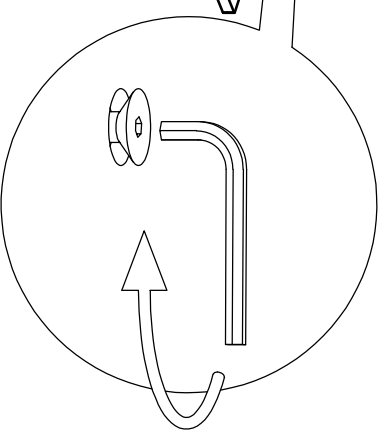

FI



25x25x3mm

x 6

S



M8x40mm

x 8

SW



5 mm

x 1