

Modell

Stammtisch mit Hydrolift

z.B. 5684,5688

VE9385

Platte
hochziehen

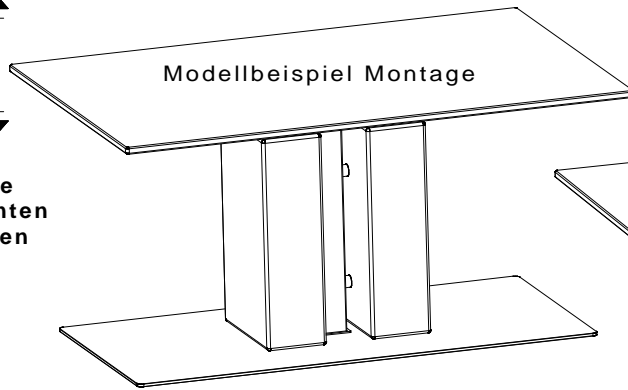
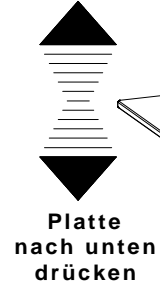

Platte
hochziehen

Platte
nach unten
drücken

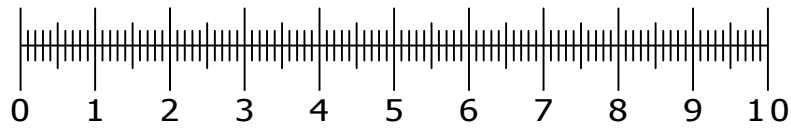
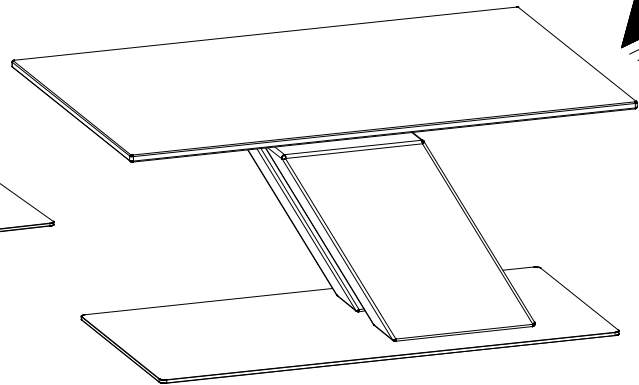

(D) Montageanleitung

(GB) Assembly instructions

(NL) Handleiding voor de montage

(PL) Instrukcja montażu

(TR) Montaj talimati

(RU) ИНСТРУКЦИЯ ПО МОНТАЖУ

03 / 2014

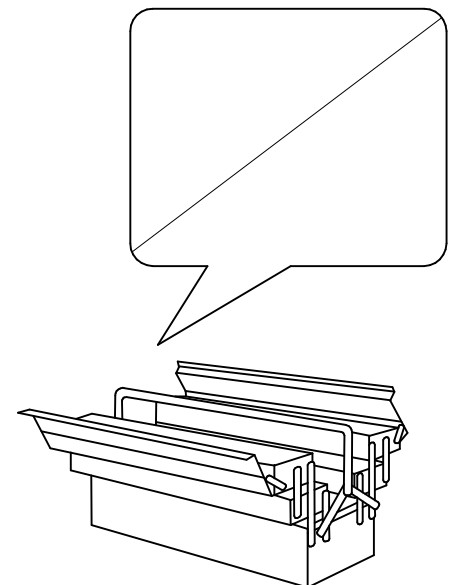
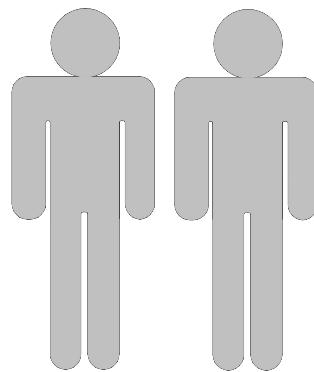



Service • Dienstverlening • Serwis • Servis • Сервисная служба

Name • Naam • Nazwa • İsim • Название

Nr. • No. • Номер

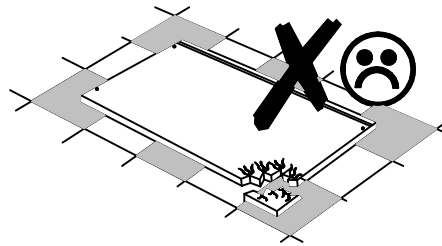
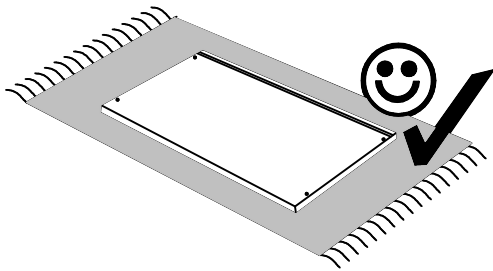
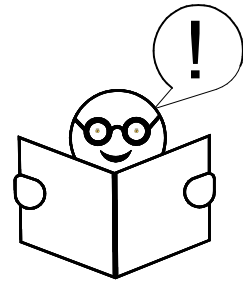
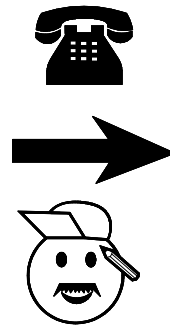
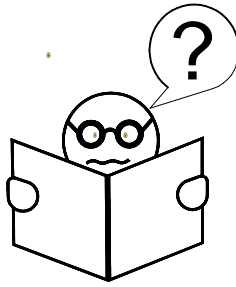
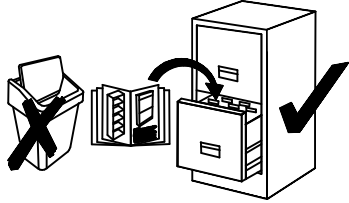
Typ • Type • Тип • Тип



1  4 x	2 SW5  1 x	3	4	5	6
7	8	9	10	11	12

