

LAURA

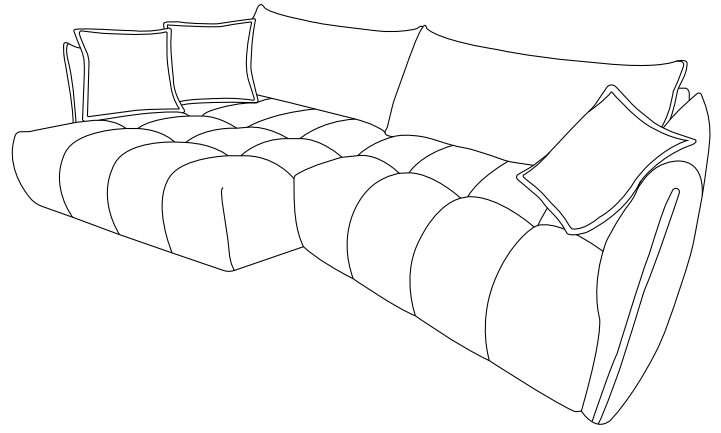

5min

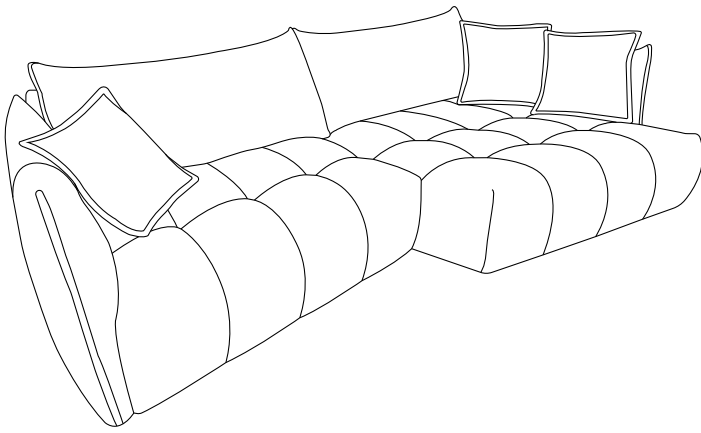
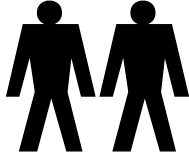

I

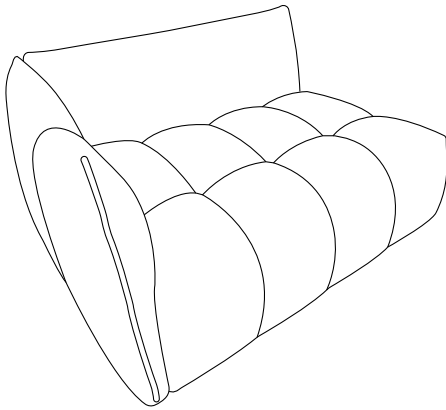

II

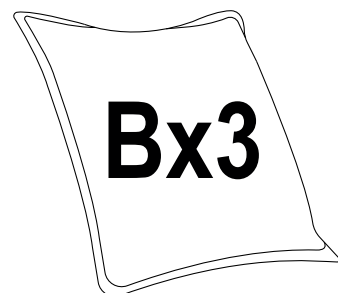
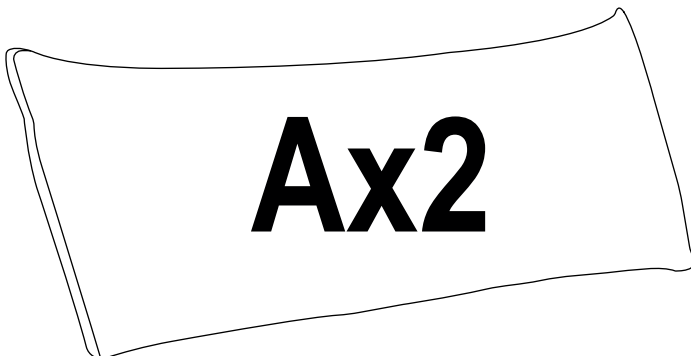
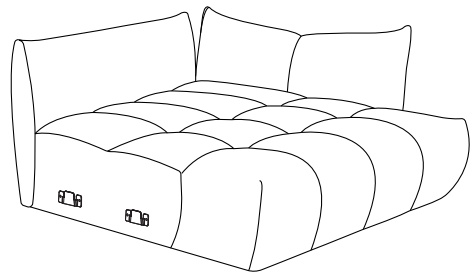

1

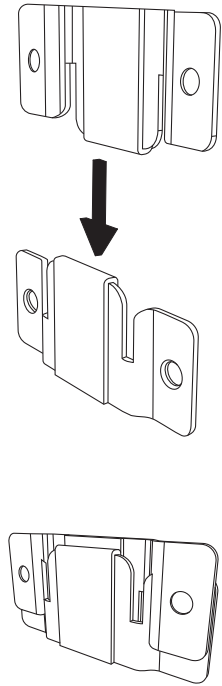
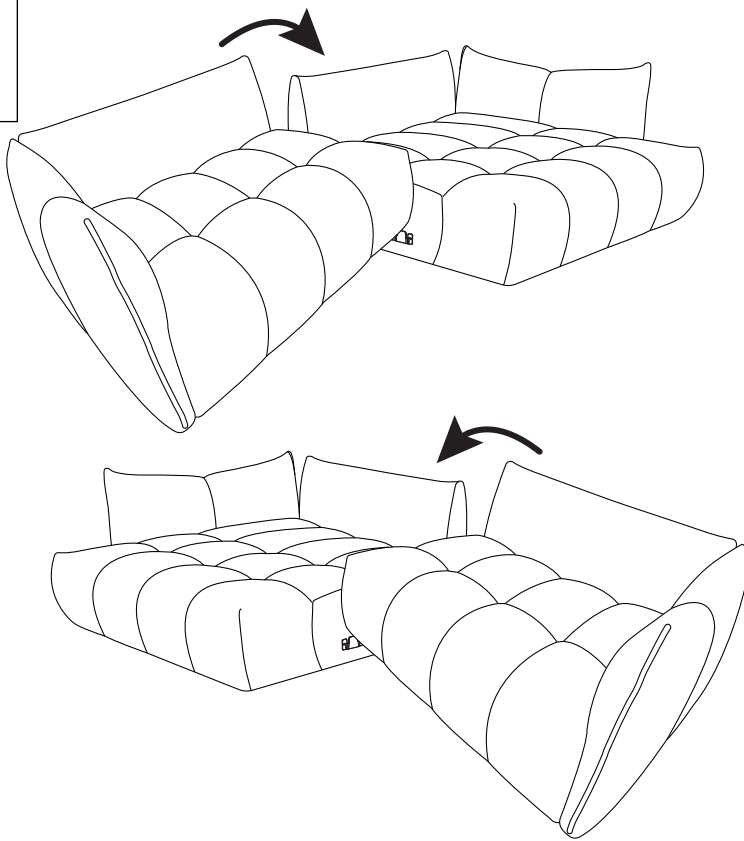

2

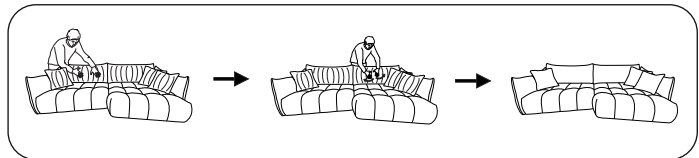
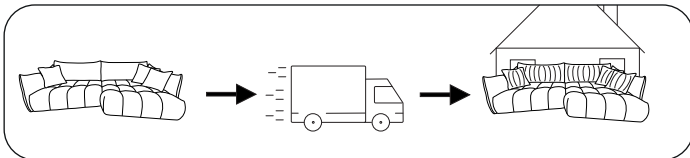
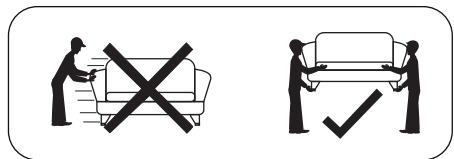
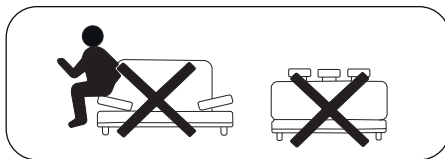
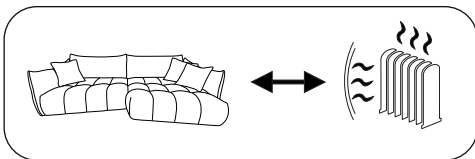
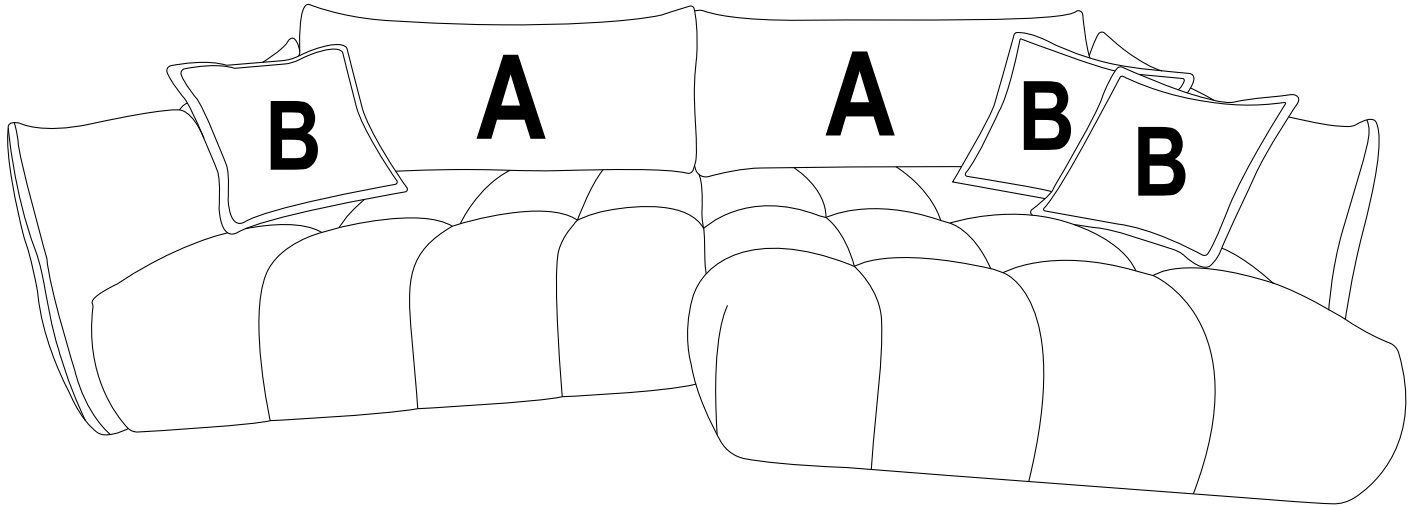

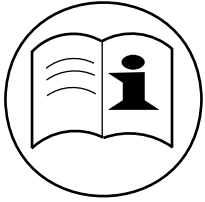

LAURA



5min

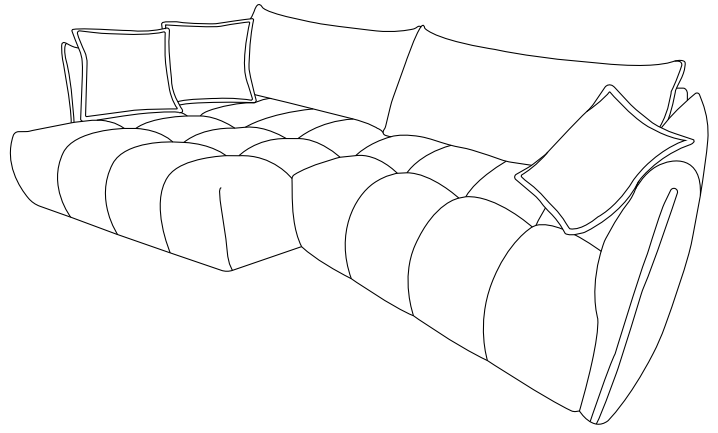
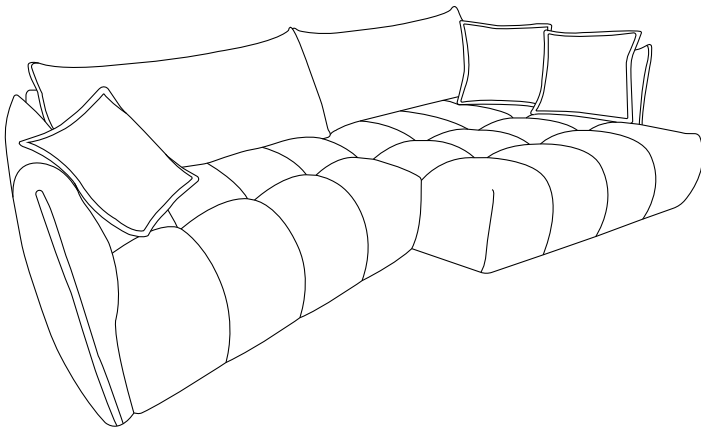
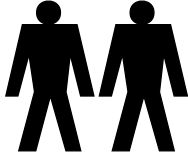

I

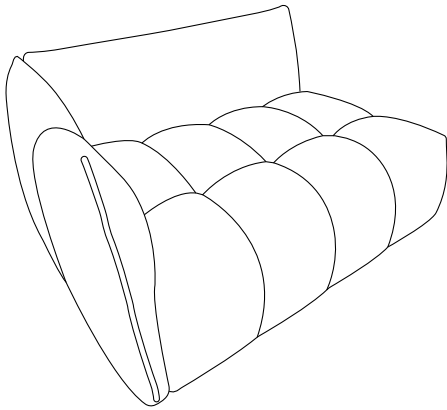

II

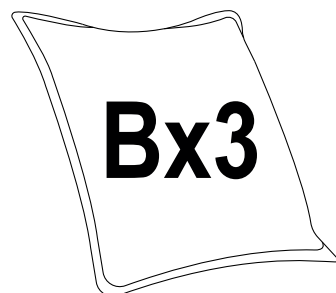
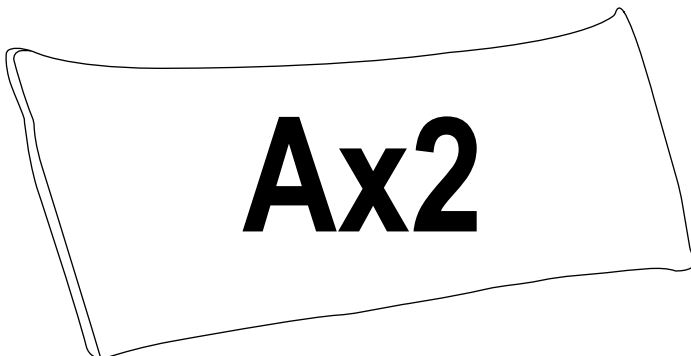
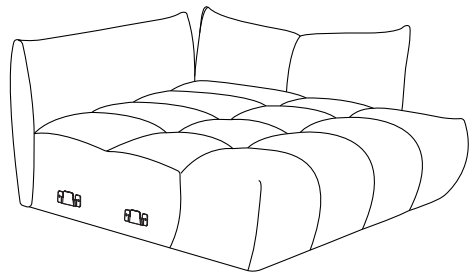

1

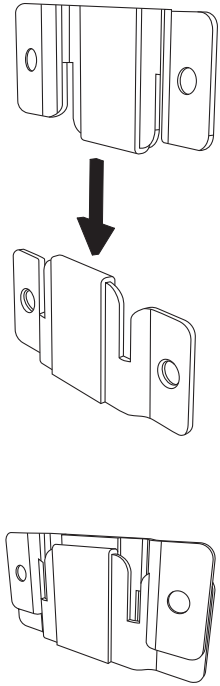
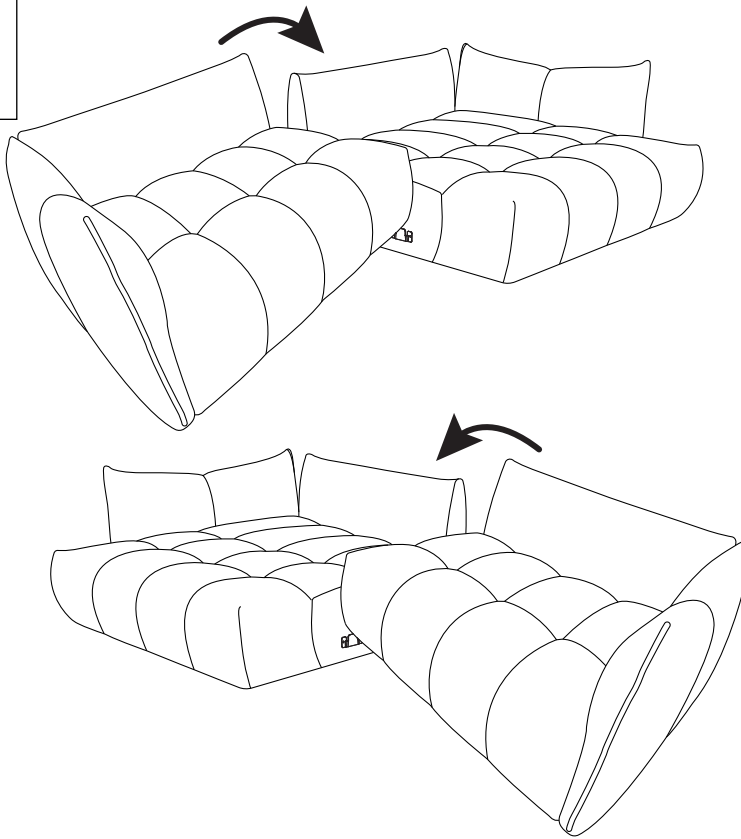

2

