

MINGO

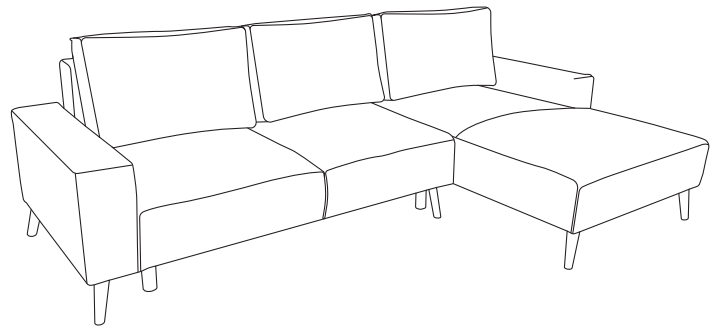

30min

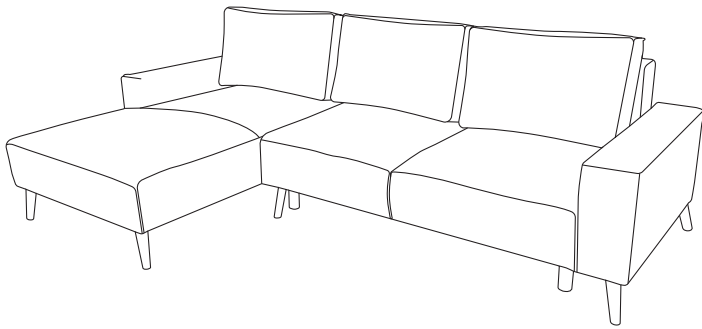
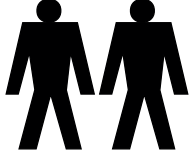

I

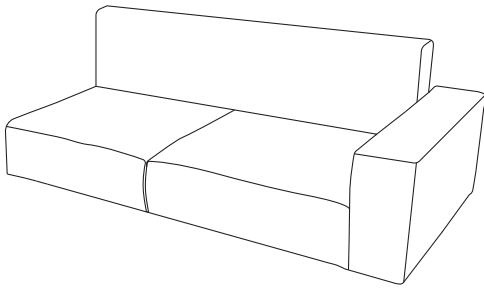

II

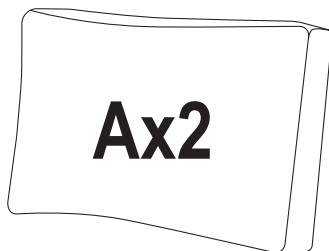
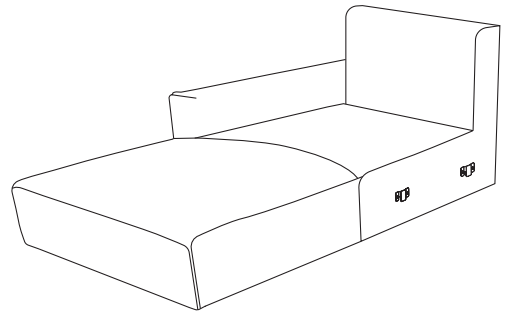

Ax2

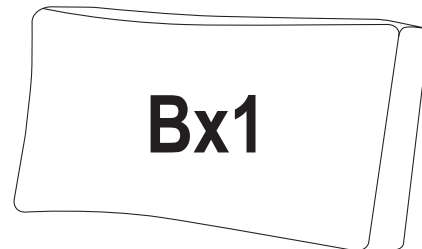

Bx1

Ax6



H= 160 mm

Bx1

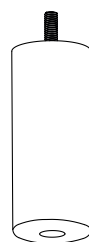

H= 160 mm

Cx4

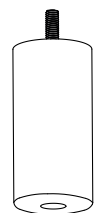

H= 110 mm

1

Ax3



H= 160 mm

Cx4



H= 110 mm

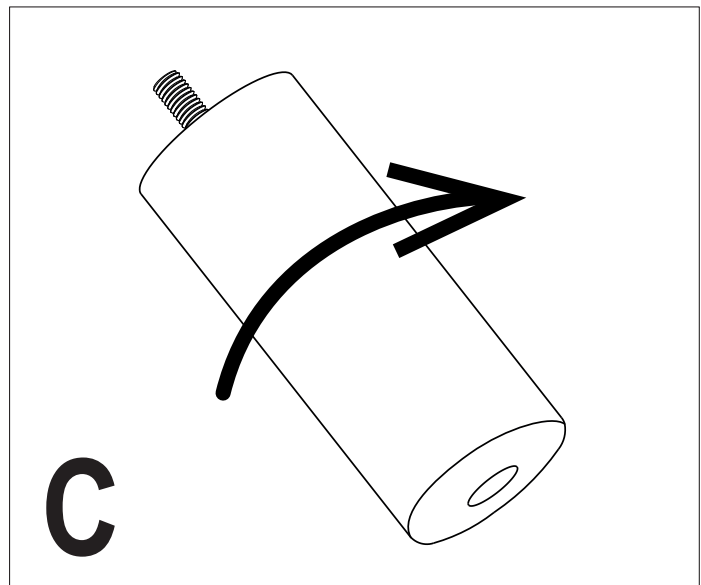
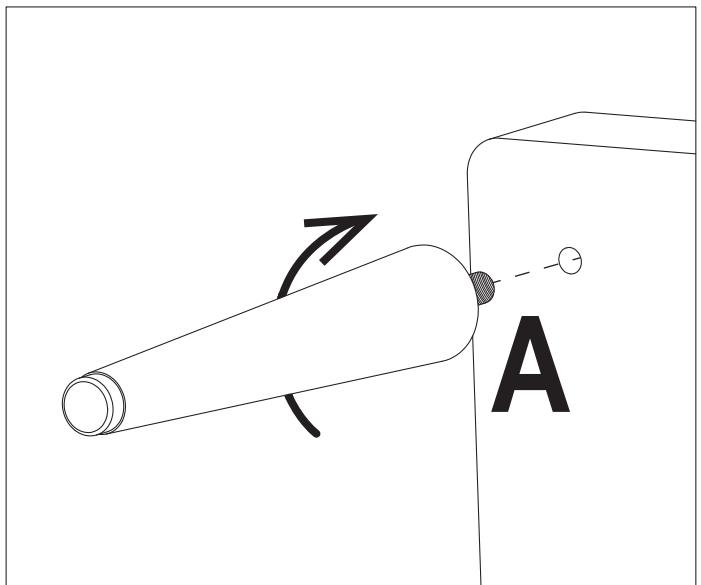

2

Ax3



H= 160 mm

Bx1

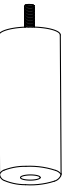

H= 160 mm

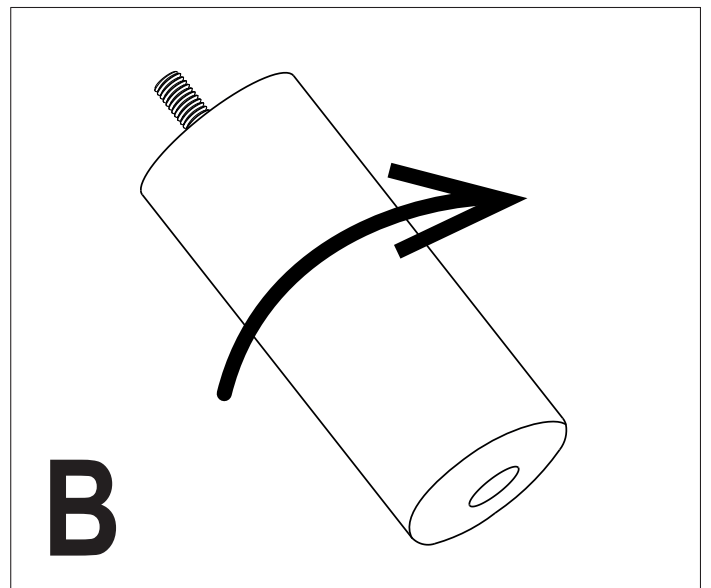
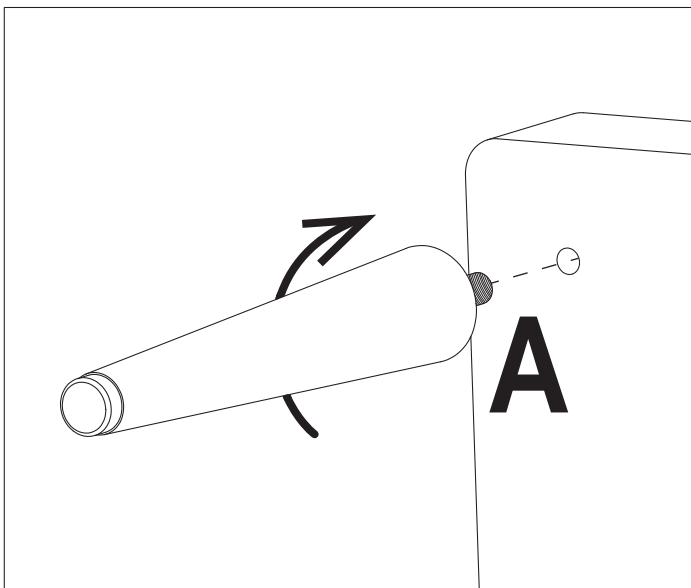
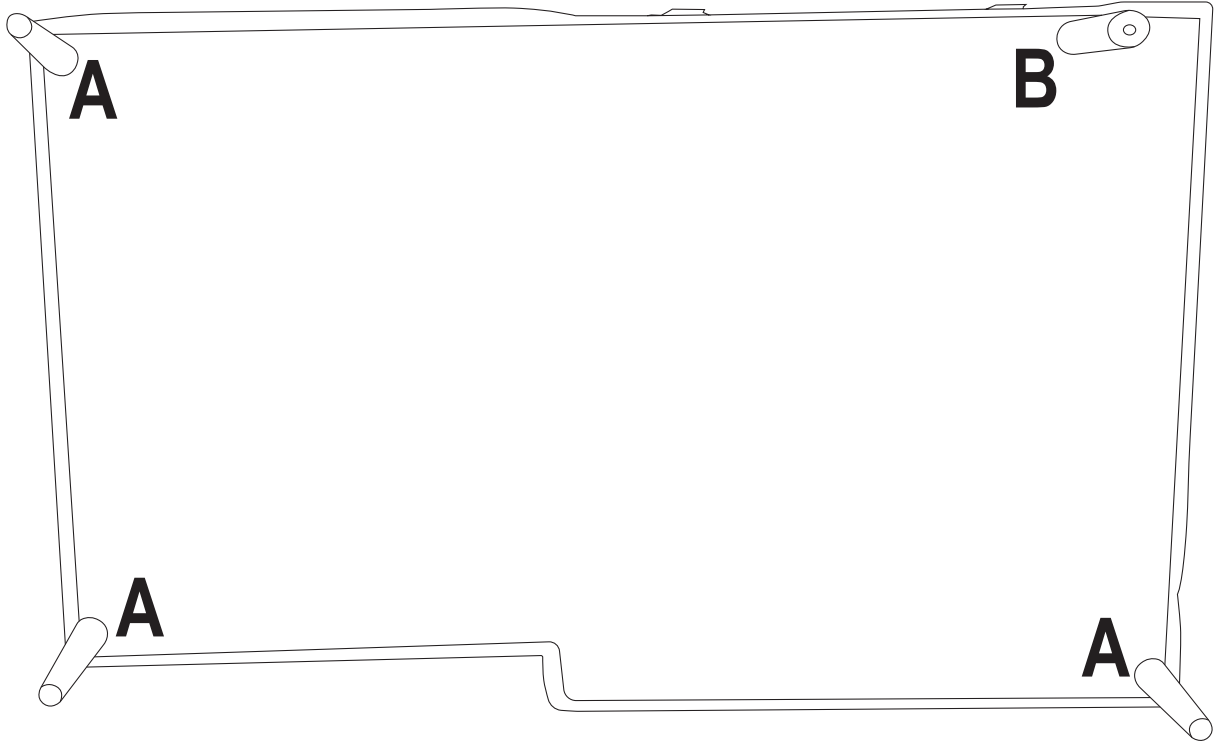

3

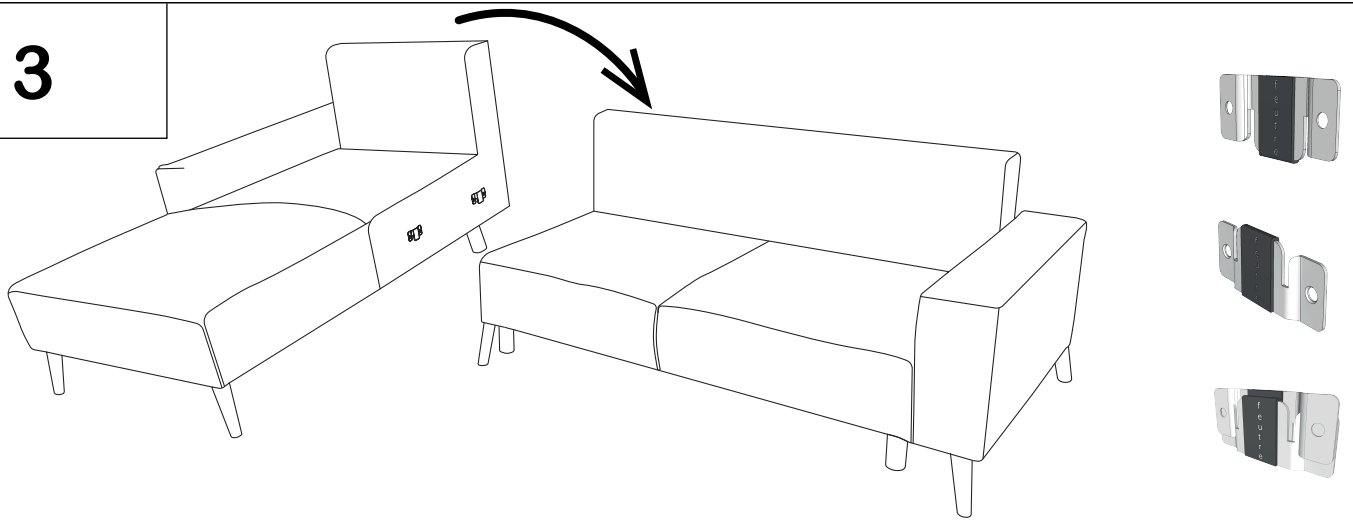

4

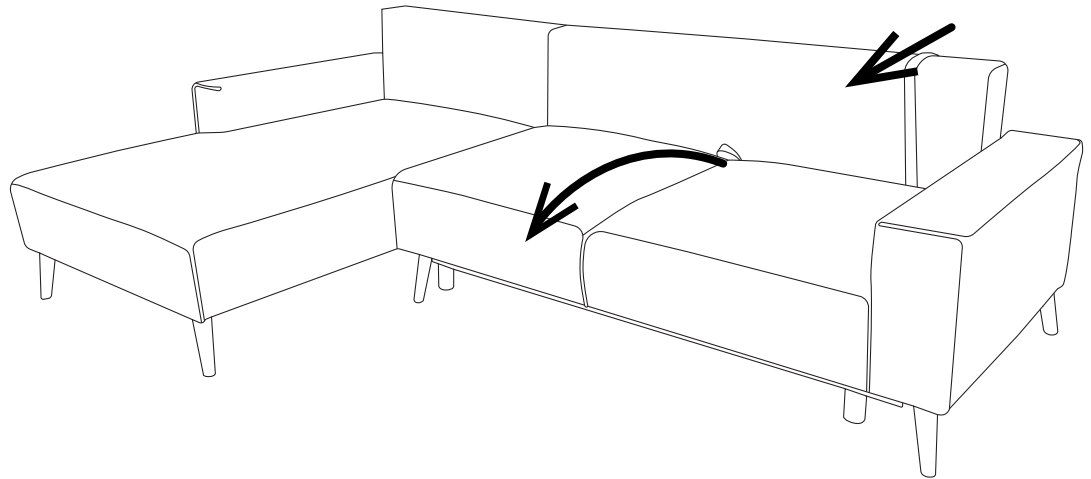

5

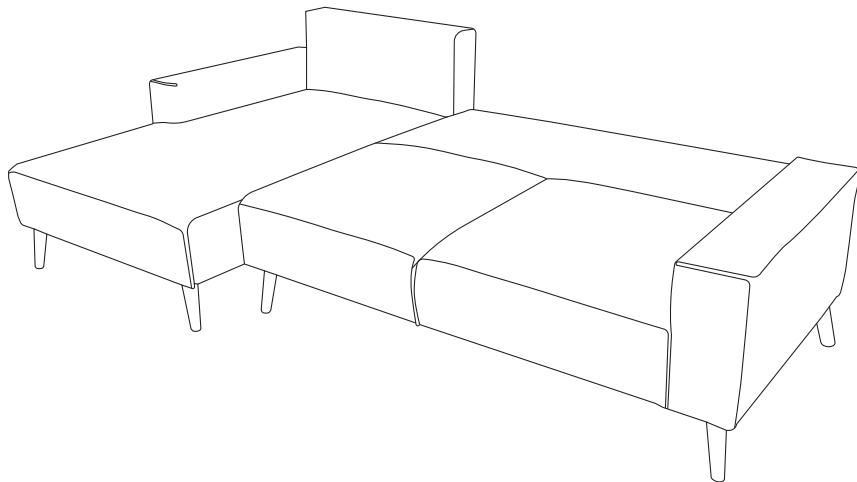

6

