

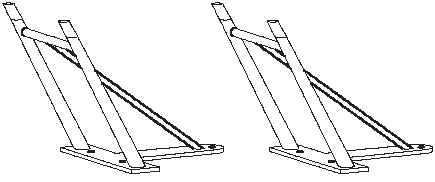
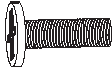

ASSEMBLY INSTRUCTIONS

ITEM CODE # 65913

LABEL	PICTURE	DESCRIPTION	QTY.
(A)		TOP	01 Pc.
(B)		LEGS	02 Pcs.

HARDWARE LIST

LABEL	PICTURE	DESCRIPTION	QTY.
(H1)		ALLEN BOLT	06 Pcs.
(H2)		FLAT WASHER	06 Pcs.

TOOL LIST

LABEL	PICTURE	DESCRIPTION	QTY.
(T1)		ALLEN KEY	01 Pc.

STEPS:

STEP: 01

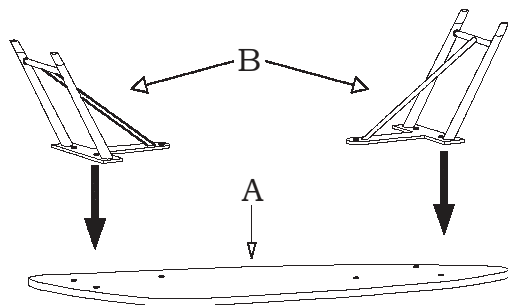

STEP: 02

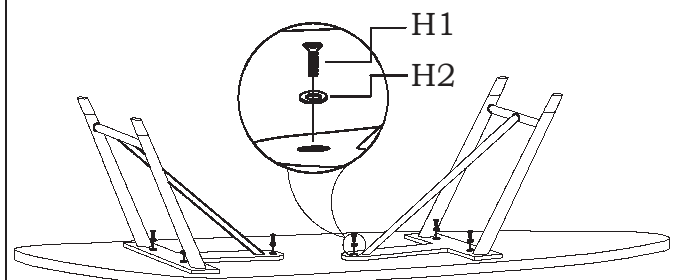

STEP: 02

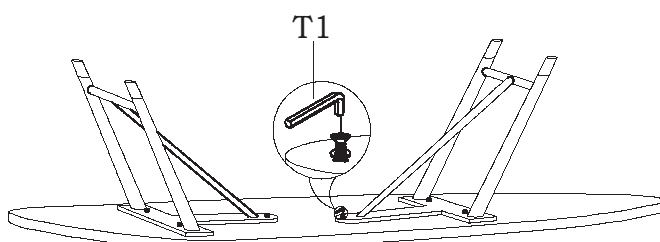

FINAL PICTURE

