

- (D) AUFBAUANLEITUNG
- (NL) HANDLEIDING VOOR DE MONTAGE
- (TR) MONTAJ TALIMATI
- (RO) INSTRUCIUNI DE ASAMBLARE
- (F) INSTRUCTION D'ASSEMBLAGE
- (CZ) POKYNY K MONTÁŽI
- (BG) ИНСТРУКЦИИ ЗА МОНТАЖ
- (HR) NAPUTCI ZA MONTAŽU
- (E) INSTRUCCIONES DE MONTAJE

- (GB) ASSEMBLY INSTRUCTIONS
- (PL) INSTRUKCJA MONTAŻU
- (RU) Инструкция по монтажу
- (I) PROCEDURA DI ASSEMBLAGGIO
- (SK) POKYNY K MONTÁŽI
- (HU) KÖZGYŰLÉS UTASÍTÁSOK
- (SLO) ASSEMBLY INSTRUCTIONS
- (S) MONTERINGSANVISNING
- (LT) DIEGIMO INSTRUKCIJOS

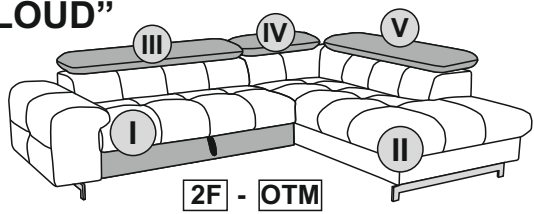

„NATA / CLOUD”



2F - OTM

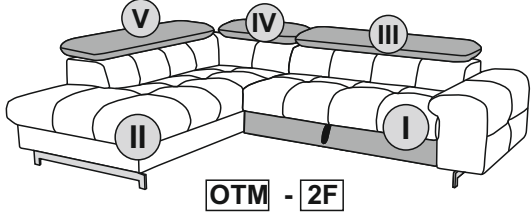

OTM - 2F

1/3

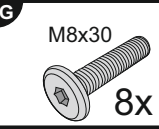
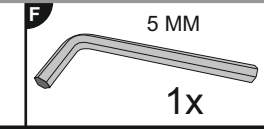
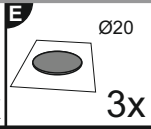
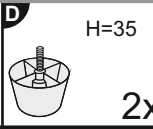
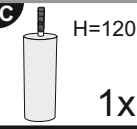
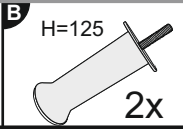
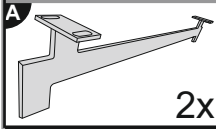

PRE-ASSEMBLED/
PRÉ ASSEMBLÉ/
VORMONTIERT/
PREMONTATO/
WSTĘPNIE
ZAMONTOWANE

HARDWARE BAG / SACHET MATÉRIEL / ZUBEHÖRBEUTEL / SACCHETTI MATERIALE / BOLSA DE MATERIALES / WREK MATERIALOWY

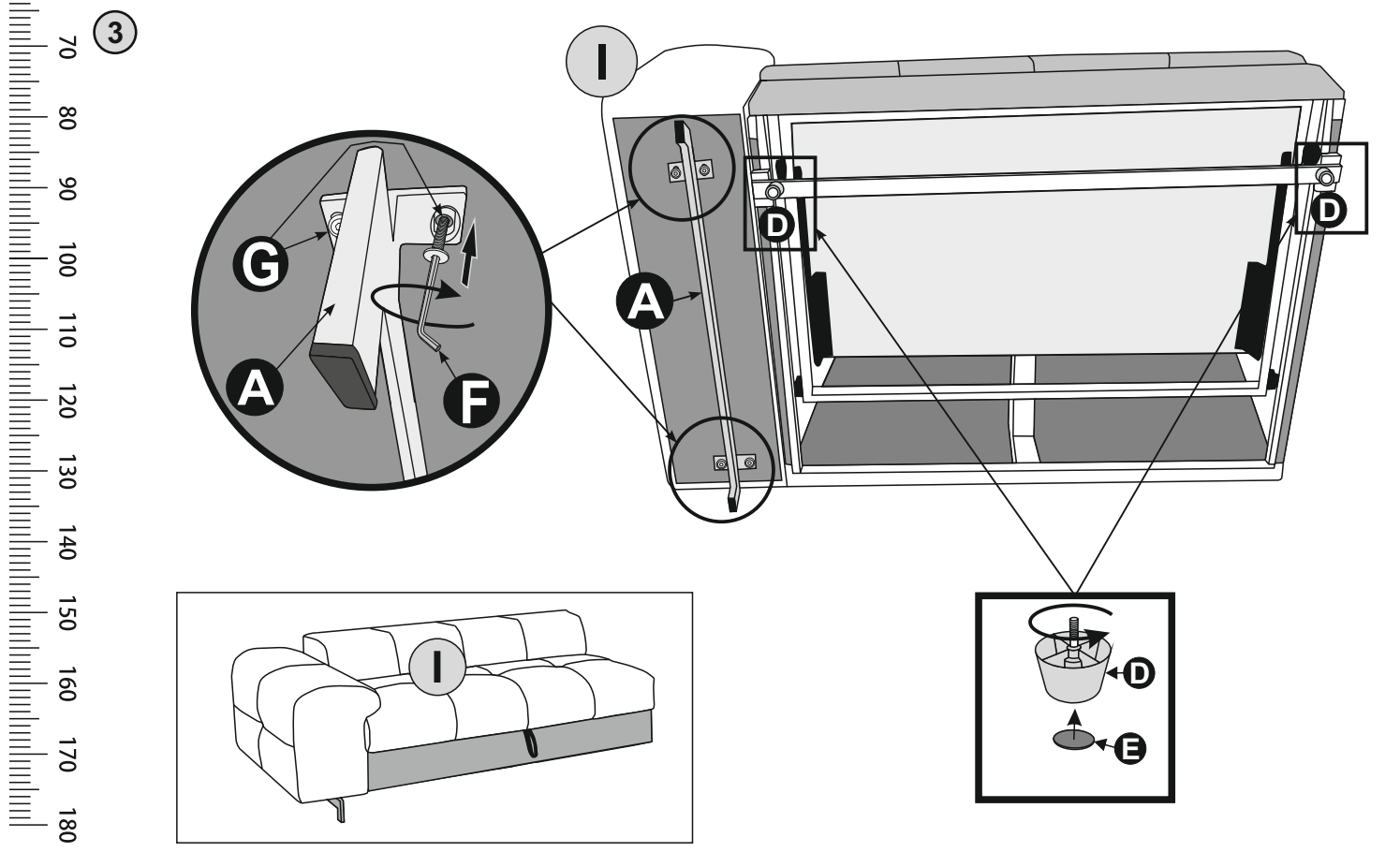
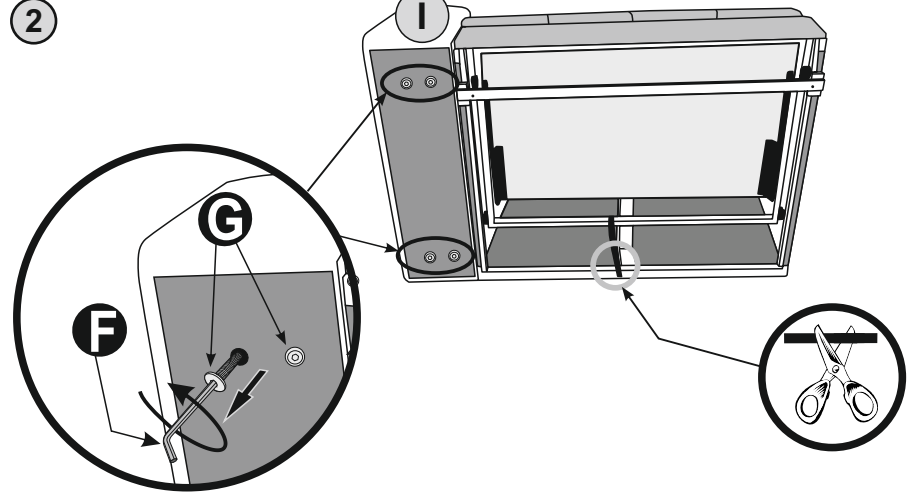
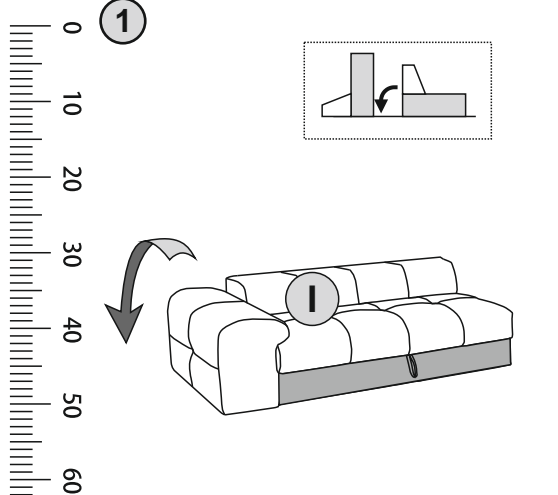

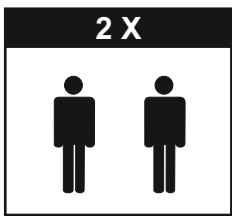

- (D) AUFBAUANLEITUNG
- (NL) HANDLEIDING VOOR DE MONTAGE
- (TR) MONTAJ TALIMATI
- (RO) INSTRUCTIUNI DE ASAMBLARE
- (F) INSTRUCTION D'ASSEMBLAGE
- (CZ) POKYNY K MONTÁŽI
- (BG) ИНСТРУКЦИИ ЗА МОНТАЖ
- (HR) NAPUTCI ZA MONTAŽU
- (E) INSTRUCCIONES DE MONTAJE

- (GB) ASSEMBLY INSTRUCTIONS
- (PL) INSTRUKCJA MONTAŻU
- (RU) Инструкция по монтажу
- (I) PROCEDURA DI ASSEMBLAGGIO
- (SK) POKYNY K MONTÁŽI
- (HU) KÖZGYŰLÉS UTASÍTÁSOK
- (SLO) ASSEMBLY INSTRUCTIONS
- (S) MONTERINGSANVISNING
- (LT) DIEGIMO INSTRUKCIJOS



„NATA / CLOUD”

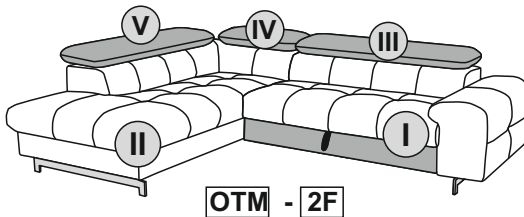
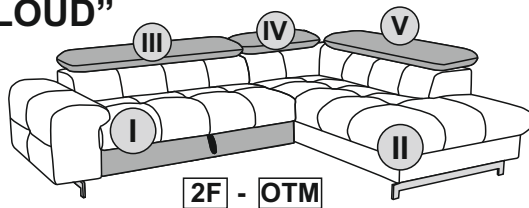

2/3

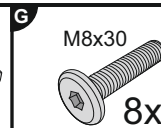
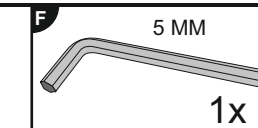
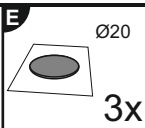
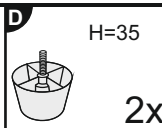
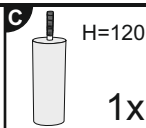
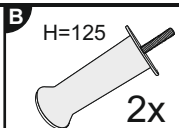
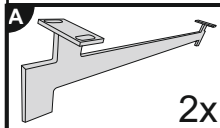

PRE-ASSEMBLED/
PRÉ ASSEMBLÉ/
VORMONTIERT/
PREMONTATO/
WSTĘPNIE
ZAMONTOWANE

HARDWARE BAG / SACHET MATÉRIEL / ZUBEHÖRBEUTEL / SACCHETTI MATERIALE / BOLSA DE MATERIALES / WOREK MATERIALOWY

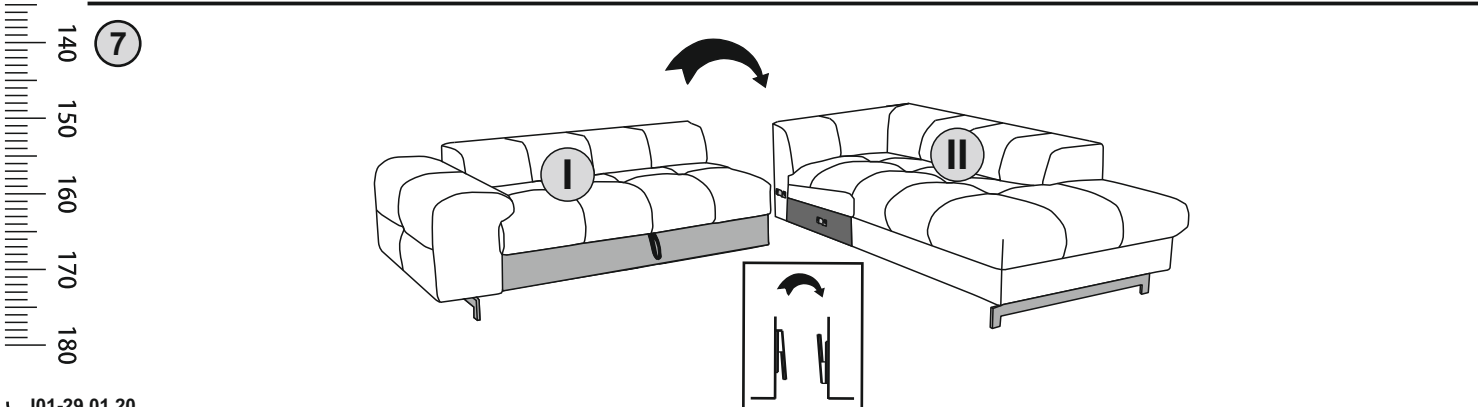
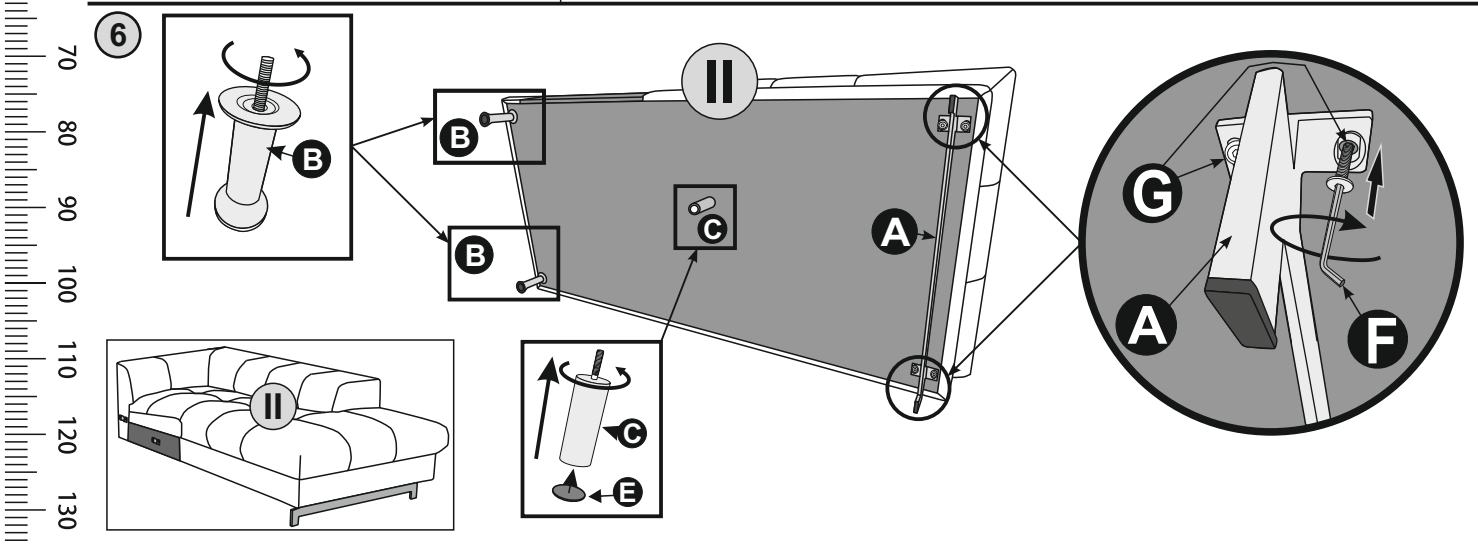
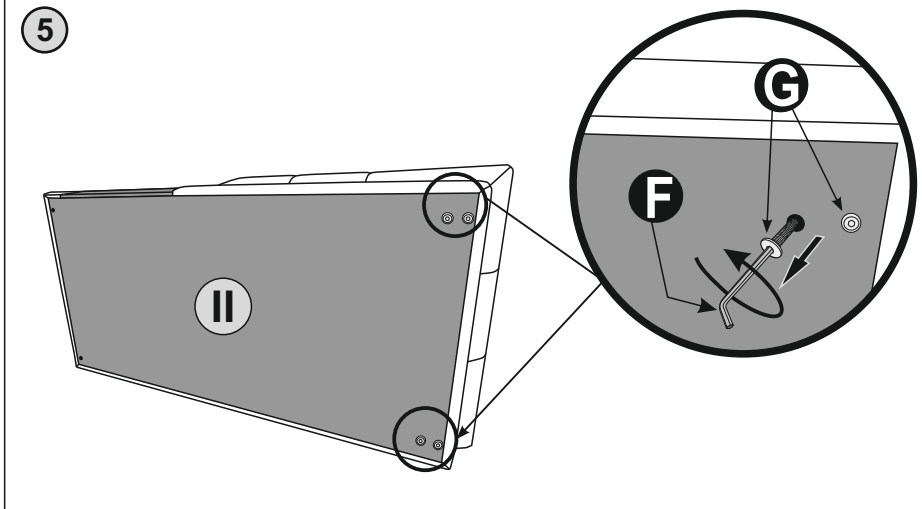
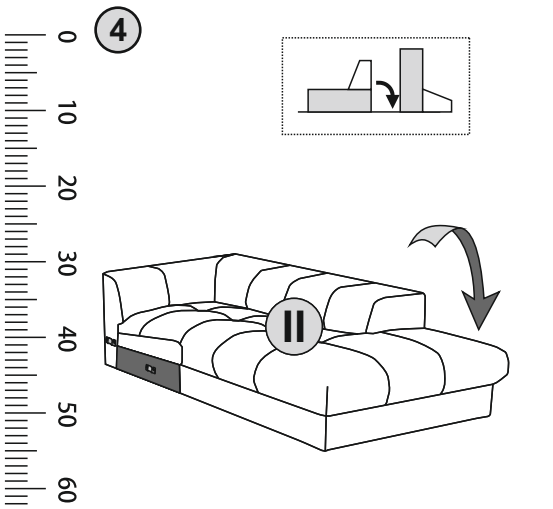

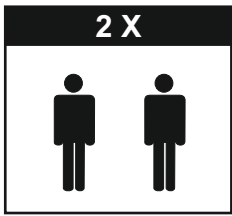

- (D) AUFBAUANLEITUNG
- (NL) HANDLEIDING VOOR DE MONTAGE
- (TR) MONTAJ TALIMATI
- (RO) INSTRUCIUNI DE ASAMBLARE
- (F) INSTRUCTION D'ASSEMBLAGE
- (CZ) POKYNY K MONTÁŽI
- (BG) ИНСТРУКЦИИ ЗА МОНТАЖ
- (HR) NAPUTCI ZA MONTAŽU
- (E) INSTRUCCIONES DE MONTAJE
- (GB) ASSEMBLY INSTRUCTIONS
- (PL) INSTRUKCJA MONTAŻU
- (RU) Инструкция по монтажу
- (I) PROCEDURA DI ASSEMBLAGGIO
- (SK) POKYNY K MONTÁŽI
- (HU) KÖZGYŰLÉS UTASÍTÁSOK
- (SL) ASSEMBLY INSTRUCTIONS
- (S) MONTERINGSANVISNING
- (LT) DIEGIMO INSTRUKCIJOS



„NATA / CLOUD”

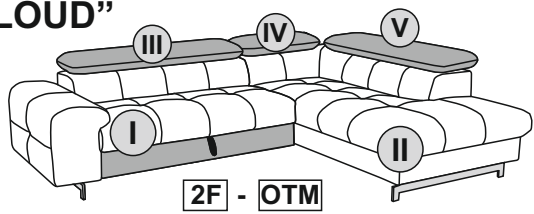

2F - OTM

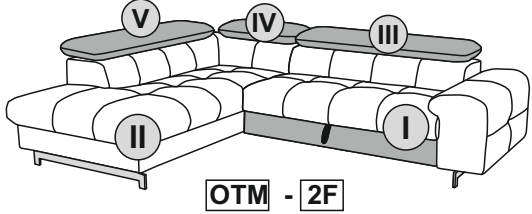

OTM - 2F

3/3

8

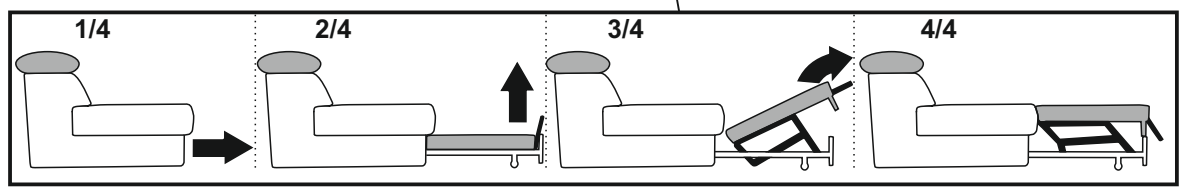
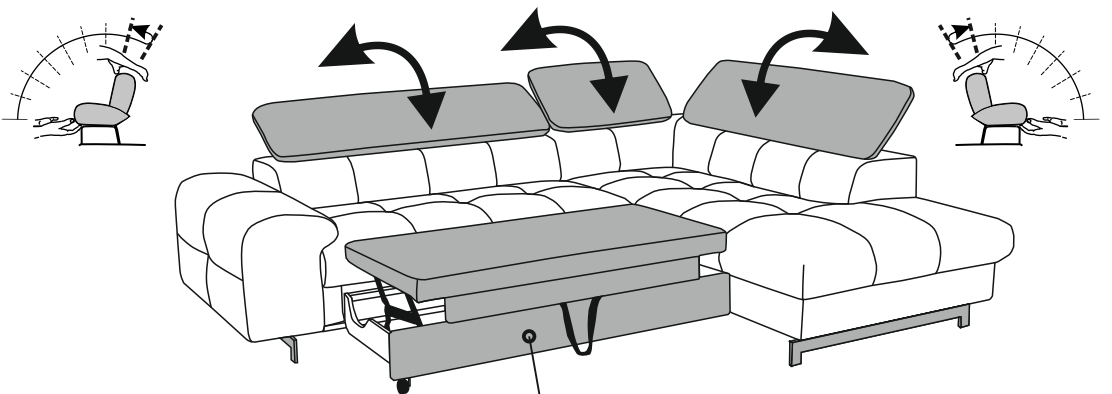
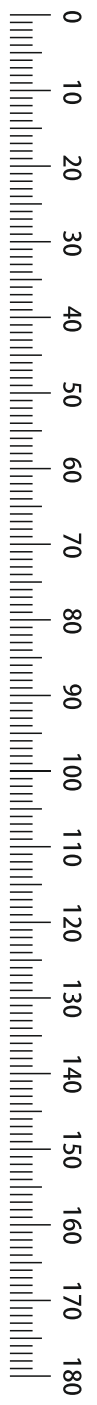
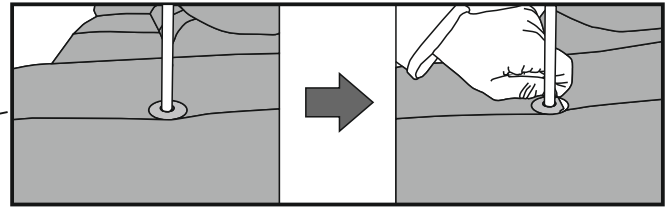
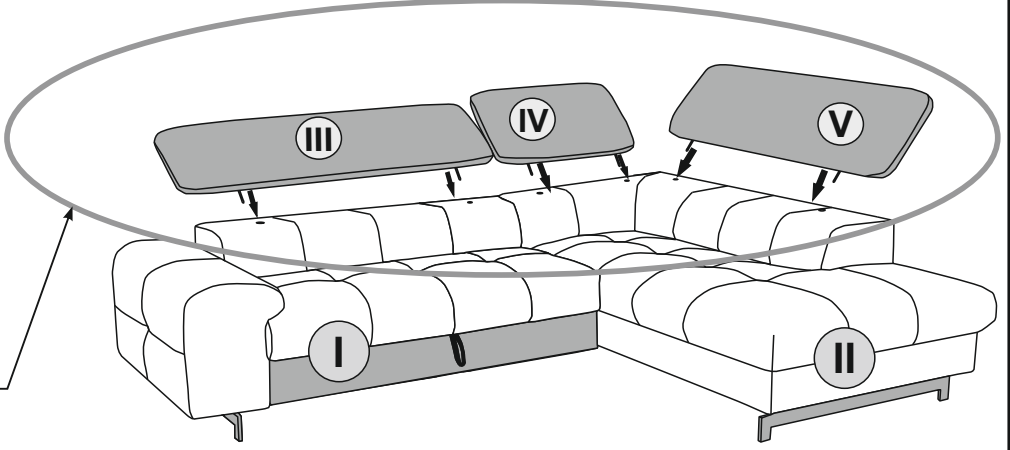
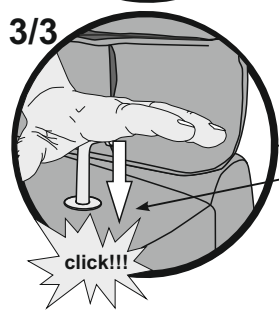
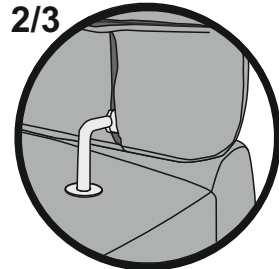
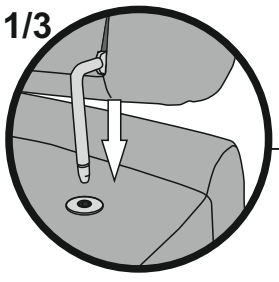

PENSEZ AU TRI! ENSEMBLE REDUISON L'IMPACT ENVIRONNEMENTAL DES EMBALLAGES

ÉLÉMENTS BOIS PLASTIQUE A JETER

ÉLÉMENTS MÉTAL CARTON PAPIER A RECYCLER